



**THE DATASHEET OF
CD19FD182FO3F**



Mica Capacitors, Standard Dipped

Types CD10, D10, CD15, CD19, CD30, CD42, CDV19, CDV30



Stability and mica go hand-in-hand when you need to count on stable capacitance over a wide temperature range. CDE's standard dipped silvered mica capacitors are the first choice for timing and close tolerance applications. These standard types are widely available through distribution.

Highlights

- Reel packaging available
- High temperature – up to +150 °C
- Dimensions meet EIA RS153B specification
- 100,000 V/μs dV/dt pulse capability minimum
- Non-flammable units that meet IEC 695-2-2 are available

[Click here to see ordering information](#)

Specifications

Capacitance Range	1 pF to 91,000 pF
Capacitance Tolerance	±1/2 pF (D), ±1 pF (C), ±1/2% (E), ±1% (F), ±2% (G), ±5% (J)
Rated Voltage	100 Vdc to 2500 Vdc
Operating Temperature Range	-55 °C to +125 °C (O) -55 °C to +150 °C (P)*
Dielectric Strength Test	200% of rated voltage
Regulatory Information	

* P temperature range available for types CD10, CD15, CD19, CD30 and CD42

Dimensions

Construction Details	
Case Material	Epoxy
Terminal Material	Copper clad steel, nickle undercoat, 100% tin finish

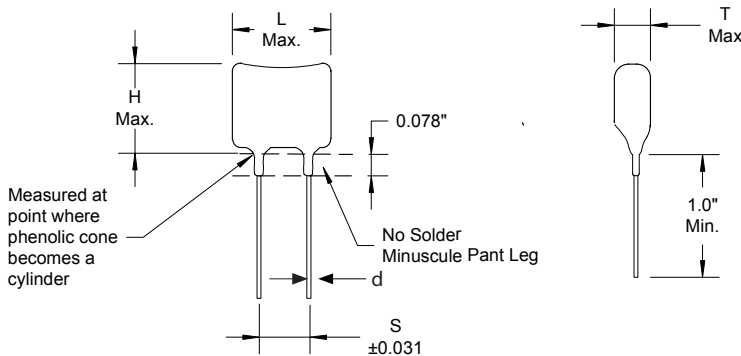

Mica Capacitors, Standard Dipped

Types CD10, D10, CD15, CD19, CD30, CD42, CDV19, CDV30

Ratings

Cap (pF)	Volts (Vdc)	Catalog Part Number	L (in) (mm)	H (in) (mm)	T (in) (mm)	S (in) (mm)	d (in) (mm)
1	500	CD10CD010DO3F	0.36 (9.1)	0.33 (8.4)	0.19 (4.8)	0.141 (3.6)	0.016 (.4)
1	500	CD15CD010DO3F	0.45 (11.4)	0.36 (9.1)	0.17 (4.3)	0.234 (5.9)	0.025 (.6)
2	500	CD10CD020DO3F	0.36 (9.1)	0.33 (8.4)	0.19 (4.8)	0.141 (3.6)	0.016 (.4)
2	500	CD15CD020DO3F	0.45 (11.4)	0.36 (9.1)	0.17 (4.3)	0.234 (5.9)	0.025 (.6)
3	500	CD10CD030DO3F	0.36 (9.1)	0.33 (8.4)	0.19 (4.8)	0.141 (3.6)	0.016 (.4)
3	500	CD15CD030DO3F	0.45 (11.4)	0.36 (9.1)	0.17 (4.3)	0.234 (5.9)	0.025 (.6)
4	500	CD15CD040DO3F	0.45 (11.4)	0.36 (9.1)	0.17 (4.3)	0.234 (5.9)	0.025 (.6)
5	500	CD10CD050DO3F	0.36 (9.1)	0.33 (8.4)	0.19 (4.8)	0.141 (3.6)	0.016 (.4)
5	500	CD15CD050DO3F	0.45 (11.4)	0.36 (9.1)	0.17 (4.3)	0.234 (5.9)	0.025 (.6)
5	1,000	CDV19CF050DO3F	0.64 (16.3)	0.50 (12.7)	0.19 (4.8)	0.344 (8.7)	0.032 (.8)
6	500	CD10CD060DO3F	0.36 (9.1)	0.33 (8.4)	0.19 (4.8)	0.141 (3.6)	0.016 (.4)
6	500	CD15CD060DO3F	0.45 (11.4)	0.36 (9.1)	0.17 (4.3)	0.234 (5.9)	0.025 (.6)
6	1,000	CDV19CF060DO3F	0.64 (16.3)	0.50 (12.7)	0.19 (4.8)	0.344 (8.7)	0.032 (.8)
7	500	CD10CD070DO3F	0.36 (9.1)	0.33 (8.4)	0.19 (4.8)	0.141 (3.6)	0.016 (.4)
7	500	CD15CD070DO3F	0.45 (11.4)	0.36 (9.1)	0.17 (4.3)	0.234 (5.9)	0.025 (.6)
7	1,000	CDV19CF070DO3F	0.64 (16.3)	0.50 (12.7)	0.19 (4.8)	0.344 (8.7)	0.032 (.8)
8	500	CD10CD080DO3F	0.36 (9.1)	0.33 (8.4)	0.19 (4.8)	0.141 (3.6)	0.016 (.4)
8	500	CD15CD080DO3F	0.45 (11.4)	0.36 (9.1)	0.17 (4.3)	0.234 (5.9)	0.025 (.6)
8	1,000	CDV19CF080DO3F	0.64 (16.3)	0.50 (12.7)	0.19 (4.8)	0.344 (8.7)	0.032 (.8)
10	500	CD10CD100JO3F	0.36 (9.1)	0.33 (8.4)	0.19 (4.8)	0.141 (3.6)	0.016 (.4)
10	500	CD15CD100JO3F	0.45 (11.4)	0.36 (9.1)	0.17 (4.3)	0.234 (5.9)	0.025 (.6)
10	1,000	CDV19CF100JO3F	0.64 (16.3)	0.50 (12.7)	0.19 (4.8)	0.344 (8.7)	0.032 (.8)
12	500	CD10CD120JO3F	0.36 (9.1)	0.33 (8.4)	0.19 (4.8)	0.141 (3.6)	0.016 (.4)
12	500	CD15CD120JO3F	0.45 (11.4)	0.36 (9.1)	0.17 (4.3)	0.234 (5.9)	0.025 (.6)
12	1,000	CDV19CF120JO3F	0.64 (16.3)	0.50 (12.7)	0.19 (4.8)	0.344 (8.7)	0.032 (.8)
15	500	CD10CD150JO3F	0.36 (9.1)	0.33 (8.4)	0.19 (4.8)	0.141 (3.6)	0.016 (.4)
15	500	CD15CD150JO3F	0.45 (11.4)	0.36 (9.1)	0.17 (4.3)	0.234 (5.9)	0.025 (.6)
15	1000	CDV19CF150JO3F	0.64 (16.3)	0.50 (12.7)	0.19 (4.8)	0.344 (8.7)	0.032 (.8)
18	500	CD10CD180JO3F	0.36 (9.1)	0.33 (8.4)	0.19 (4.8)	0.141 (3.6)	0.016 (.4)
18	500	CD15CD180JO3F	0.45 (11.4)	0.36 (9.1)	0.17 (4.3)	0.234 (5.9)	0.025 (.6)
18	1000	CDV19CF180JO3F	0.64 (16.3)	0.50 (12.7)	0.19 (4.8)	0.344 (8.7)	0.032 (. 8)
20	500	CD10ED200JO3F	0.36 (9.1)	0.33 (8.4)	0.19 (4.8)	0.141 (3.6)	0.016 (. 4)
20	500	CD15ED200JO3F	0.45 (11.4)	0.36 (9.1)	0.17 (4.3)	0.234 (5.9)	0.025 (. 6)
20	1000	CDV19EF200JO3F	0.64 (16.3)	0.50 (12.7)	0.19 (4.8)	0.344 (8.7)	0.032 (. 8)
22	500	CD10ED220JO3F	0.36 (9.1)	0.33 (8.4)	0.19 (4.8)	0.141 (3.6)	0.016 (. 4)
22	500	CD15ED220JO3F	0.45 (11.4)	0.36 (9.1)	0.17 (4.3)	0.234 (5.9)	0.025 (. 6)
22	1000	CDV19EF220JO3F	0.64 (16.3)	0.50 (12.7)	0.19 (4.8)	0.344 (8.7)	0.032 (. 8)
24	500	CD10ED240JO3F	0.36 (9.1)	0.33 (8.4)	0.19 (4.8)	0.141 (3.6)	0.016 (. 4)
24	500	CD15ED240JO3F	0.45 (11.4)	0.36 (9.1)	0.17 (4.3)	0.234 (5.9)	0.025 (. 6)
24	1000	CDV19EF240JO3F	0.64 (16.3)	0.50 (12.7)	0.19 (4.8)	0.344 (8.7)	0.032 (. 8)
24	1,500	CDV30EH240JO3F	0.77 (19.6)	0.85 (21.6)	0.25 (6.4)	0.438 (11.1)	0.040 (1.0)
24	2000	CDV30EJ240JO3F	0.77 (19.6)	0.86 (21.8)	0.25 (6.4)	0.438 (11.1)	0.040 (1.0)
24	2500	CDV30EK240JO3F	0.78 (19.8)	0.86 (21.8)	0.25 (6.4)	0.438 (11.1)	0.040 (1.0)
27	500	CD10ED270JO3F	0.37 (9.4)	0.33 (8.4)	0.19 (4.8)	0.141 (3.6)	0.016 (. 4)
27	500	CD15ED270JO3F	0.45 (11.4)	0.36 (9.1)	0.17 (4.3)	0.234 (5.9)	0.025 (. 6)

Mica Capacitors, Standard Dipped



Types CD10, D10, CD15, CD19, CD30, CD42, CDV19, CDV30

Cap (pF)	Volts (Vdc)	Catalog Part Number	L (in) (mm)	H (in) (mm)	T (in) (mm)	S (in) (mm)	d (in) (mm)
27	1000	CDV19EF270JO3F	0.64 (16.3)	0.50 (12.7)	0.19 (4.8)	0.344 (8.7)	0.032 (.8)
27	1500	CDV30EH270JO3F	0.77 (19.6)	0.85 (21.6)	0.25 (6.4)	0.438 (11.1)	0.040 (1.0)
27	2000	CDV30EJ270JO3F	0.77 (19.6)	0.86 (21.8)	0.25 (6.4)	0.438 (11.1)	0.040 (1.0)
27	2500	CDV30EK270JO3F	0.78 (19.8)	0.86 (21.8)	0.25 (6.4)	0.438 (11.1)	0.040 (1.0)
30	500	CD10ED300JO3F	0.37 (9.4)	0.34 (8.6)	0.19 (4.8)	0.141 (3.6)	0.016 (.4)
30	500	CD15ED300JO3F	0.45 (11.4)	0.36 (9.1)	0.17 (4.3)	0.234 (5.9)	0.025 (.6)
30	1000	CDV19EF300JO3F	0.64 (16.3)	0.50 (12.7)	0.19 (4.8)	0.344 (8.7)	0.032 (.8)
30	1500	CDV30EH300JO3F	0.77 (19.6)	0.85 (21.6)	0.25 (6.4)	0.438 (11.1)	0.040 (1.0)
30	2000	CDV30EJ300JO3F	0.77 (19.6)	0.86 (21.8)	0.25 (6.4)	0.438 (11.1)	0.040 (1.0)
30	2,500	CDV30EK300JO3F	0.78 (19.8)	0.86 (21.8)	0.25 (6.4)	0.438 (11.1)	0.040 (1.0)
33	500	CD10ED330JO3F	0.37 (9.4)	0.34 (8.6)	0.19 (4.8)	0.141 (3.6)	0.016 (.4)
33	500	CD15ED330JO3F	0.45 (11.4)	0.36 (9.1)	0.17 (4.3)	0.234 (5.9)	0.025 (.6)
33	1,000	CDV19EF330JO3F	0.64 (16.3)	0.50 (12.7)	0.19 (4.8)	0.344 (8.7)	0.032 (.8)
33	1500	CDV30EH330JO3F	0.77 (19.6)	0.85 (21.6)	0.25 (6.4)	0.438 (11.1)	0.040 (1.0)
33	2000	CDV30EJ330JO3F	0.77 (19.6)	0.86 (21.8)	0.25 (6.4)	0.438 (11.1)	0.040 (1.0)
33	2,500	CDV30EK330JO3F	0.78 (19.8)	0.86 (21.8)	0.25 (6.4)	0.438 (11.1)	0.040 (1.0)
36	500	CD10ED360JO3F	0.37 (9.4)	0.34 (8.6)	0.19 (4.8)	0.141 (3.6)	0.016 (.4)
36	500	CD15ED360JO3F	0.45 (11.4)	0.36 (9.1)	0.17 (4.3)	0.234 (5.9)	0.025 (.6)
36	1,000	CDV19EF360JO3F	0.64 (16.3)	0.50 (12.7)	0.19 (4.8)	0.344 (8.7)	0.032 (.8)
36	1500	CDV30EH360JO3F	0.77 (19.6)	0.85 (21.6)	0.25 (6.4)	0.438 (11.1)	0.040 (1.0)
36	2000	CDV30EJ360JO3F	0.77 (19.6)	0.86 (21.8)	0.25 (6.4)	0.438 (11.1)	0.040 (1.0)
36	2,500	CDV30EK360JO3F	0.78 (19.8)	0.86 (21.8)	0.25 (6.4)	0.438 (11.1)	0.040 (1.0)
39	500	CD10ED390JO3F	0.37 (9.4)	0.34 (8.6)	0.19 (4.8)	0.141 (3.6)	0.016 (.4)
39	500	CD15ED390JO3F	0.45 (11.4)	0.36 (9.1)	0.17 (4.3)	0.234 (5.9)	0.025 (.6)
39	1,000	CDV19EF390JO3F	0.64 (16.3)	0.50 (12.7)	0.19 (4.8)	0.344 (8.7)	0.032 (.8)
39	1500	CDV30EH390JO3F	0.77 (19.6)	0.85 (21.6)	0.25 (6.4)	0.438 (11.1)	0.040 (1.0)
39	2000	CDV30EJ390JO3F	0.77 (19.6)	0.86 (21.8)	0.25 (6.4)	0.438 (11.1)	0.040 (1.0)
39	2500	CDV30EK390JO3F	0.78 (19.8)	0.86 (21.8)	0.25 (6.4)	0.438 (11.1)	0.040 (1.0)
43	500	CD10ED430JO3F	0.37 (9.4)	0.34 (8.6)	0.19 (4.8)	0.141 (3.6)	0.016 (.4)
43	500	CD15ED430JO3F	0.45 (11.4)	0.36 (9.1)	0.17 (4.3)	0.234 (5.9)	0.025 (.6)
43	1000	CDV19EF430JO3F	0.64 (16.3)	0.50 (12.7)	0.19 (4.8)	0.344 (8.7)	0.032 (.8)
43	1500	CDV30EH430JO3F	0.77 (19.6)	0.85 (21.6)	0.25 (6.4)	0.438 (11.1)	0.040 (1.0)
43	2000	CDV30EJ430JO3F	0.77 (19.6)	0.86 (21.8)	0.25 (6.4)	0.438 (11.1)	0.040 (1.0)
43	2500	CDV30EK430JO3F	0.78 (19.8)	0.86 (21.8)	0.25 (6.4)	0.438 (11.1)	0.040 (1.0)
47	500	CD10ED470JO3F	0.37 (9.4)	0.34 (8.6)	0.19 (4.8)	0.141 (3.6)	0.016 (.4)
47	500	CD15ED470JO3F	0.45 (11.4)	0.36 (9.1)	0.17 (4.3)	0.234 (5.9)	0.025 (.6)
47	1000	CDV19EF470JO3F	0.64 (16.3)	0.50 (12.7)	0.19 (4.8)	0.344 (8.7)	0.032 (.8)
47	1,500	CDV30EH470JO3F	0.77 (19.6)	0.85 (21.6)	0.25 (6.4)	0.438 (11.1)	0.040 (1.0)
47	2000	CDV30EJ470JO3F	0.77 (19.6)	0.86 (21.8)	0.25 (6.4)	0.438 (11.1)	0.040 (1.0)
47	2500	CDV30EK470JO3F	0.78 (19.8)	0.86 (21.8)	0.25 (6.4)	0.438 (11.1)	0.040 (1.0)
50	500	CD10ED500JO3F	0.37 (9.4)	0.34 (8.6)	0.19 (4.8)	0.141 (3.6)	0.016 (.4)
50	500	CD15ED500JO3F	0.45 (11.4)	0.36 (9.1)	0.17 (4.3)	0.234 (5.9)	0.025 (.6)
50	1000	CDV19EF500JO3F	0.64 (16.3)	0.50 (12.7)	0.19 (4.8)	0.344 (8.7)	0.032 (.8)
50	1,500	CDV30EH500JO3F	0.77 (19.6)	0.85 (21.6)	0.25 (6.4)	0.438 (11.1)	0.040 (1.0)
50	2,000	CDV30EJ500JO3F	0.77 (19.6)	0.86 (21.8)	0.25 (6.4)	0.438 (11.1)	0.040 (1.0)

Mica Capacitors, Standard Dipped

Types CD10, D10, CD15, CD19, CD30, CD42, CDV19, CDV30



Cap (pF)	Volts (Vdc)	Catalog Part Number	L (in) (mm)	H (in) (mm)	T (in) (mm)	S (in) (mm)	d (in) (mm)
50	2500	CDV30EK500JO3F	0.78 (19.8)	0.86 (21.8)	0.25 (6.4)	0.438 (11.1)	0.040 (1.0)
51	500	CD10ED510JO3F	0.37 (9.4)	0.34 (8.6)	0.19 (4.8)	0.141 (3.6)	0.016 (. 4)
51	500	CD15ED510JO3F	0.45 (11.4)	0.36 (9.1)	0.17 (4.3)	0.234 (5.9)	0.025 (. 6)
51	1000	CDV19EF510JO3F	0.64 (16.3)	0.50 (12.7)	0.19 (4.8)	0.344 (8.7)	0.032 (. 8)
51	1500	CDV30EH510JO3F	0.77 (19.6)	0.85 (21.6)	0.25 (6.4)	0.438 (11.1)	0.040 (1.0)
51	2000	CDV30EJ510JO3F	0.77 (19.6)	0.86 (21.8)	0.25 (6.4)	0.438 (11.1)	0.040 (1.0)
51	2500	CDV30EK510JO3F	0.78 (19.8)	0.86 (21.8)	0.25 (6.4)	0.438 (11.1)	0.040 (1.0)
56	500	CD10ED560JO3F	0.37 (9.4)	0.34 (8.6)	0.19 (4.8)	0.141 (3.6)	0.016 (. 4)
56	500	CD15ED560JO3F	0.45 (11.4)	0.36 (9.1)	0.17 (4.3)	0.234 (5.9)	0.025 (. 6)
56	1,000	CDV19EF560JO3F	0.64 (16.3)	0.50 (12.7)	0.19 (4.8)	0.344 (8.7)	0.032 (. 8)
56	1500	CDV30EH560JO3F	0.77 (19.6)	0.85 (21.6)	0.25 (6.4)	0.438 (11.1)	0.040 (1.0)
56	2500	CDV30EK560JO3F	0.78 (19.8)	0.86 (21.8)	0.25 (6.4)	0.438 (11.1)	0.040 (1.0)
62	500	CD10ED620JO3F	0.37 (9.4)	0.34 (8.6)	0.19 (4.8)	0.141 (3.6)	0.016 (. 4)
62	500	CD15ED620JO3F	0.45 (11.4)	0.36 (9.1)	0.17 (4.3)	0.234 (5.9)	0.025 (. 6)
62	1000	CDV19EF620JO3F	0.64 (16.3)	0.50 (12.7)	0.19 (4.8)	0.344 (8.7)	0.032 (. 8)
62	1,500	CDV30EH620JO3F	0.77 (19.6)	0.85 (21.6)	0.25 (6.4)	0.438 (11.1)	0.040 (1.0)
62	2000	CDV30EJ620JO3F	0.77 (19.6)	0.86 (21.8)	0.25 (6.4)	0.438 (11.1)	0.040 (1.0)
62	2500	CDV30EK620JO3F	0.78 (19.8)	0.86 (21.8)	0.25 (6.4)	0.438 (11.1)	0.040 (1.0)
68	500	CD10ED680JO3F	0.37 (9.4)	0.34 (8.6)	0.19 (4.8)	0.141 (3.6)	0.016 (. 4)
68	500	CD15ED680JO3F	0.45 (11.4)	0.36 (9.1)	0.18 (4.6)	0.234 (5.9)	0.025 (. 6)
68	1000	CDV19EF680JO3F	0.64 (16.3)	0.50 (12.7)	0.19 (4.8)	0.344 (8.7)	0.032 (. 8)
68	1,500	CDV30EH680JO3F	0.77 (19.6)	0.85 (21.6)	0.25 (6.4)	0.438 (11.1)	0.040 (1.0)
68	2000	CDV30EJ680JO3F	0.77 (19.6)	0.86 (21.8)	0.25 (6.4)	0.438 (11.1)	0.040 (1.0)
68	2500	CDV30EK680JO3F	0.78 (19.8)	0.86 (21.8)	0.25 (6.4)	0.438 (11.1)	0.040 (1.0)
75	500	CD10ED750JO3F	0.37 (9.4)	0.34 (8.6)	0.20 (5.1)	0.141 (3.6)	0.016 (. 4)
75	500	CD15ED750JO3F	0.45 (11.4)	0.36 (9.1)	0.18 (4.6)	0.234 (5.9)	0.025 (. 6)
75	1000	CDV19EF750JO3F	0.64 (16.3)	0.50 (12.7)	0.19 (4.8)	0.344 (8.7)	0.032 (. 8)
75	1500	CDV30EH750JO3F	0.77 (19.6)	0.85 (21.6)	0.25 (6.4)	0.438 (11.1)	0.040 (1.0)
75	2000	CDV30EJ750JO3F	0.77 (19.6)	0.86 (21.8)	0.25 (6.4)	0.438 (11.1)	0.040 (1.0)
75	2500	CDV30EK750JO3F	0.78 (19.8)	0.86 (21.8)	0.25 (6.4)	0.438 (11.1)	0.040 (1.0)
82	500	CD10ED820JO3F	0.37 (9.4)	0.35 (8.9)	0.20 (5.1)	0.141 (3.6)	0.016 (. 4)
82	500	CD15ED820JO3F	0.45 (11.4)	0.36 (9.1)	0.18 (4.6)	0.234 (5.9)	0.025 (. 6)
82	1000	CDV19EF820JO3F	0.64 (16.3)	0.50 (12.7)	0.19 (4.8)	0.344 (8.7)	0.032 (. 8)
82	1500	CDV30EH820JO3F	0.77 (19.6)	0.85 (21.6)	0.25 (6.4)	0.438 (11.1)	0.040 (1.0)
82	2,000	CDV30EJ820JO3F	0.77 (19.6)	0.86 (21.8)	0.25 (6.4)	0.438 (11.1)	0.040 (1.0)
82	2500	CDV30EK820JO3F	0.78 (19.8)	0.86 (21.8)	0.25 (6.4)	0.438 (11.1)	0.040 (1.0)
91	500	CD10FD910JO3F	0.37 (9.4)	0.35 (8.9)	0.20 (5.1)	0.141 (3.6)	0.016 (. 4)
91	500	CD15FD910JO3F	0.46 (11.7)	0.36 (9.1)	0.18 (4.6)	0.234 (5.9)	0.025 (. 6)
91	1000	CDV19FF910JO3F	0.64 (16.3)	0.50 (12.7)	0.19 (4.8)	0.344 (8.7)	0.032 (. 8)
91	1500	CDV30FH910JO3F	0.77 (19.6)	0.85 (21.6)	0.25 (6.4)	0.438 (11.1)	0.040 (1.0)
91	2,000	CDV30FJ910JO3F	0.77 (19.6)	0.86 (21.8)	0.25 (6.4)	0.438 (11.1)	0.040 (1.0)
91	2500	CDV30FK910JO3F	0.78 (19.8)	0.86 (21.8)	0.25 (6.4)	0.438 (11.1)	0.040 (1.0)
100	500	CD10FD101JO3F	0.37 (9.4)	0.35 (8.9)	0.20 (5.1)	0.141 (3.6)	0.016 (. 4)
100	500	CD15FD101JO3F	0.46 (11.7)	0.36 (9.1)	0.18 (4.6)	0.234 (5.9)	0.025 (. 6)
100	500	CD19FD101JO3F	0.64 (16.3)	0.50 (12.7)	0.19 (4.8)	0.344 (8.7)	0.032 (. 8)

Mica Capacitors, Standard Dipped

Types CD10, D10, CD15, CD19, CD30, CD42, CDV19, CDV30



Cap (pF)	Volts (Vdc)	Catalog Part Number	L (in) (mm)	H (in) (mm)	T (in) (mm)	S (in) (mm)	d (in) (mm)
100	1000	CDV19FF101JO3F	0.64 (16.3)	0.50 (12.7)	0.19 (4.8)	0.344 (8.7)	0.032 (.8)
100	1500	CDV30FH101JO3F	0.77 (19.6)	0.85 (21.6)	0.25 (6.4)	0.438 (11.1)	0.040 (1.0)
100	2,000	CDV30FJ101JO3F	0.77 (19.6)	0.86 (21.8)	0.25 (6.4)	0.438 (11.1)	0.040 (1.0)
100	2,500	CDV30FK101JO3F	0.78 (19.8)	0.86 (21.8)	0.25 (6.4)	0.438 (11.1)	0.040 (1.0)
110	500	CD10FD111JO3F	0.38 (9.7)	0.35 (8.9)	0.20 (5.1)	0.141 (3.6)	0.016 (.4)
110	500	CD15FD111JO3F	0.46 (11.7)	0.37 (9.4)	0.18 (4.6)	0.234 (5.9)	0.025 (.6)
110	1000	CDV19FF111JO3F	0.64 (16.3)	0.50 (12.7)	0.19 (4.8)	0.344 (8.7)	0.032 (.8)
110	1500	CDV30FH111JO3F	0.77 (19.6)	0.85 (21.6)	0.25 (6.4)	0.438 (11.1)	0.040 (1.0)
110	2,000	CDV30FJ111JO3F	0.77 (19.6)	0.86 (21.8)	0.25 (6.4)	0.438 (11.1)	0.040 (1.0)
110	2,500	CDV30FK111JO3F	0.78 (19.8)	0.86 (21.8)	0.25 (6.4)	0.438 (11.1)	0.040 (1.0)
120	500	CD10FD121JO3F	0.38 (9.7)	0.35 (8.9)	0.20 (5.1)	0.141 (3.6)	0.016 (.4)
120	500	CD15FD121JO3F	0.46 (11.7)	0.37 (9.4)	0.18 (4.6)	0.234 (5.9)	0.025 (.6)
120	500	CD19FD121JO3F	0.64 (16.3)	0.50 (12.7)	0.19 (4.8)	0.344 (8.7)	0.032 (.8)
120	1000	CDV19FF121JO3F	0.64 (16.3)	0.50 (12.7)	0.19 (4.8)	0.344 (8.7)	0.032 (.8)
120	1,500	CDV30FH121JO3F	0.77 (19.6)	0.85 (21.6)	0.25 (6.4)	0.438 (11.1)	0.040 (1.0)
120	2,000	CDV30FJ121JO3F	0.77 (19.6)	0.86 (21.8)	0.25 (6.4)	0.438 (11.1)	0.040 (1.0)
120	2,500	CDV30FK121JO3F	0.78 (19.8)	0.86 (21.8)	0.25 (6.4)	0.438 (11.1)	0.040 (1.0)
130	500	CD10FD131JO3F	0.38 (9.7)	0.36 (9.1)	0.20 (5.1)	0.141 (3.6)	0.016 (.4)
130	500	CD15FD131JO3F	0.46 (11.7)	0.37 (9.4)	0.18 (4.6)	0.234 (5.9)	0.025 (.6)
130	1000	CDV19FF131JO3F	0.64 (16.3)	0.50 (12.7)	0.19 (4.8)	0.344 (8.7)	0.032 (.8)
130	1,500	CDV30FH131JO3F	0.77 (19.6)	0.85 (21.6)	0.25 (6.4)	0.438 (11.1)	0.040 (1.0)
130	2,000	CDV30FJ131JO3F	0.77 (19.6)	0.86 (21.8)	0.25 (6.4)	0.438 (11.1)	0.040 (1.0)
150	500	CD10FD151JO3F	0.38 (9.7)	0.36 (9.1)	0.21 (5.3)	0.141 (3.6)	0.016 (.4)
150	500	CD15FD151JO3F	0.46 (11.7)	0.37 (9.4)	0.19 (4.8)	0.234 (5.9)	0.025 (.6)
150	500	CD19FD151JO3F	0.64 (16.3)	0.50 (12.7)	0.19 (4.8)	0.344 (8.7)	0.032 (.8)
150	1000	CDV19FF151JO3F	0.64 (16.3)	0.50 (12.7)	0.19 (4.8)	0.344 (8.7)	0.032 (.8)
150	1,500	CDV30FH151JO3F	0.77 (19.6)	0.85 (21.6)	0.25 (6.4)	0.438 (11.1)	0.040 (1.0)
150	2,000	CDV30FJ151JO3F	0.77 (19.6)	0.86 (21.8)	0.25 (6.4)	0.438 (11.1)	0.040 (1.0)
160	500	CD10FD161JO3F	0.38 (9.7)	0.36 (9.1)	0.21 (5.3)	0.141 (3.6)	0.016 (.4)
160	500	CD15FD161JO3F	0.46 (11.7)	0.37 (9.4)	0.19 (4.8)	0.234 (5.9)	0.025 (.6)
160	1000	CDV19FF161JO3F	0.64 (16.3)	0.50 (12.7)	0.19 (4.8)	0.344 (8.7)	0.032 (.8)
160	1500	CDV30FH161JO3F	0.77 (19.6)	0.85 (21.6)	0.25 (6.4)	0.438 (11.1)	0.040 (1.0)
160	2,000	CDV30FJ161JO3F	0.77 (19.6)	0.86 (21.8)	0.25 (6.4)	0.438 (11.1)	0.040 (1.0)
180	500	CD10FD181JO3F	0.39 (9.9)	0.37 (9.4)	0.21 (5.3)	0.141 (3.6)	0.016 (.4)
180	500	CD15FD181JO3F	0.46 (11.7)	0.37 (9.4)	0.19 (4.8)	0.234 (5.9)	0.025 (.6)
180	500	CD19FD181JO3F	0.64 (16.3)	0.50 (12.7)	0.19 (4.8)	0.344 (8.7)	0.032 (.8)
180	1000	CDV19FF181JO3F	0.64 (16.3)	0.50 (12.7)	0.19 (4.8)	0.344 (8.7)	0.032 (.8)
180	1,500	CDV30FH181JO3F	0.77 (19.6)	0.85 (21.6)	0.25 (6.4)	0.438 (11.1)	0.040 (1.0)
180	2,000	CDV30FJ181JO3F	0.77 (19.6)	0.86 (21.8)	0.25 (6.4)	0.438 (11.1)	0.040 (1.0)
200	500	CD10FD201JO3F	0.39 (9.9)	0.37 (9.4)	0.21 (5.3)	0.141 (3.6)	0.016 (.4)
200	500	CD15FD201JO3F	0.46 (11.7)	0.38 (9.7)	0.19 (4.8)	0.234 (5.9)	0.025 (.6)
200	1000	CDV19FF201JO3F	0.64 (16.3)	0.50 (12.7)	0.19 (4.8)	0.344 (8.7)	0.032 (.8)
200	1500	CDV30FH201JO3F	0.77 (19.6)	0.85 (21.6)	0.25 (6.4)	0.438 (11.1)	0.040 (1.0)

Mica Capacitors, Standard Dipped

Types CD10, D10, CD15, CD19, CD30, CD42, CDV19, CDV30



Cap (pF)	Volts (Vdc)	Catalog Part Number	L (in) (mm)	H (in) (mm)	T (in) (mm)	S (in) (mm)	d (in) (mm)
200	2000	CDV30FJ201JO3F	0.77 (19.6)	0.86 (21.8)	0.25 (6.4)	0.438 (11.1)	0.040 (1.0)
220	500	CD10FD221JO3F	0.39 (9.9)	0.38 (9.7)	0.22 (5.6)	0.141 (3.6)	0.016 (.4)
220	500	CD15FD221JO3F	0.46 (11.7)	0.38 (9.7)	0.20 (5.1)	0.234 (5.9)	0.025 (.6)
220	500	CD19FD221JO3F	0.64 (16.3)	0.50 (12.7)	0.19 (4.8)	0.344 (8.7)	0.032 (.8)
220	1000	CDV19FF221JO3F	0.64 (16.3)	0.50 (12.7)	0.19 (4.8)	0.344 (8.7)	0.032 (.8)
220	1500	CDV30FH221JO3F	0.77 (19.6)	0.85 (21.6)	0.25 (6.4)	0.438 (11.1)	0.040 (1.0)
220	2000	CDV30FJ221JO3F	0.77 (19.6)	0.86 (21.8)	0.25 (6.4)	0.438 (11.1)	0.040 (1.0)
240	500	CD10FD241JO3F	0.39 (9.9)	0.38 (9.7)	0.22 (5.6)	0.141 (3.6)	0.016 (.4)
240	500	CD10FD241JO3F	0.39 (9.9)	0.38 (9.7)	0.22 (5.6)	0.141 (3.6)	0.016 (.4)
240	500	CD15FD241JO3F	0.46 (11.7)	0.38 (9.7)	0.20 (5.1)	0.234 (5.9)	0.025 (.6)
240	500	CD19FD241JO3F	0.64 (16.3)	0.50 (12.7)	0.19 (4.8)	0.344 (8.7)	0.032 (.8)
240	1000	CDV19FF241JO3F	0.64 (16.3)	0.50 (12.7)	0.19 (4.8)	0.344 (8.7)	0.032 (.8)
240	1,500	CDV30FH241JO3F	0.77 (19.6)	0.85 (21.6)	0.25 (6.4)	0.438 (11.1)	0.040 (1.0)
240	2000	CDV30FJ241JO3F	0.77 (19.6)	0.86 (21.8)	0.25 (6.4)	0.438 (11.1)	0.040 (1.0)
250	500	CD10FD251JO3F	0.39 (9.9)	0.38 (9.7)	0.22 (5.6)	0.141 (3.6)	0.016 (.4)
250	500	CD15FD251JO3F	0.47 (11.9)	0.39 (9.9)	0.21 (5.3)	0.234 (5.9)	0.025 (.6)
250	500	CD19FD251JO3F	0.64 (16.3)	0.50 (12.7)	0.19 (4.8)	0.344 (8.7)	0.032 (.8)
270	300	CD10FC271JO3F	0.39 (9.9)	0.38 (9.7)	0.22 (5.6)	0.141 (3.6)	0.016 (.4)
270	500	CD19FD271JO3F	0.64 (16.3)	0.50 (12.7)	0.19 (4.8)	0.344 (8.7)	0.032 (.8)
270	500	D105F271JO3F	0.39 (9.9)	0.38 (9.7)	0.22 (5.6)	0.141 (3.6)	0.016 (.4)
270	500	CD15FD271JO3F	0.47 (11.9)	0.39 (9.9)	0.21 (5.3)	0.234 (5.9)	0.025 (.6)
270	1,000	CDV19FF271JO3F	0.64 (16.3)	0.50 (12.7)	0.19 (4.8)	0.344 (8.7)	0.032 (.8)
270	1500	CDV30FH271JO3F	0.77 (19.6)	0.85 (21.6)	0.25 (6.4)	0.438 (11.1)	0.040 (1.0)
270	2000	CDV30FJ271JO3F	0.77 (19.6)	0.86 (21.8)	0.25 (6.4)	0.438 (11.1)	0.040 (1.0)
300	300	CD10FC301JO3F	0.39 (9.9)	0.38 (9.7)	0.22 (5.6)	0.141 (3.6)	0.016 (.4)
300	500	D105F301JO3F	0.39 (9.9)	0.38 (9.7)	0.22 (5.6)	0.141 (3.6)	0.016 (.4)
300	500	CD15FD301JO3F	0.47 (11.9)	0.39 (9.9)	0.21 (5.3)	0.234 (5.9)	0.025 (.6)
300	500	CD19FD301JO3F	0.64 (16.3)	0.50 (12.7)	0.19 (4.8)	0.344 (8.7)	0.032 (.8)
300	2000	CDV30FJ301JO3F	0.77 (19.6)	0.86 (21.8)	0.25 (6.4)	0.438 (11.1)	0.040 (1.0)
330	100	CD10FA331JO3F	0.39 (9.9)	0.37 (9.4)	0.22 (5.6)	0.141 (3.6)	0.016 (.4)
330	500	D105F331JO3F	0.39 (9.9)	0.38 (9.7)	0.22 (5.6)	0.141 (3.6)	0.016 (.4)
330	500	CD15FD331JO3F	0.47 (11.9)	0.39 (9.9)	0.21 (5.3)	0.234 (5.9)	0.025 (.6)
330	500	CD19FD331JO3F	0.64 (16.3)	0.50 (12.7)	0.19 (4.8)	0.344 (8.7)	0.032 (.8)
330	2000	CDV30FJ331JO3F	0.77 (19.6)	0.86 (21.8)	0.25 (6.4)	0.438 (11.1)	0.040 (1.0)
330	2,500	CDV30FK331JO3F	0.78 (19.8)	0.87 (22.1)	0.25 (6.4)	0.438 (11.1)	0.040 (1.0)
360	100	CD10FA361JO3F	0.39 (9.9)	0.38 (9.7)	0.22 (5.6)	0.141 (3.6)	0.016 (.4)
360	500	D105F361JO3F	0.39 (9.9)	0.38 (9.7)	0.22 (5.6)	0.141 (3.6)	0.016 (.4)
360	500	CD15FD361JO3F	0.47 (11.9)	0.39 (9.9)	0.21 (5.3)	0.234 (5.9)	0.025 (.6)
360	500	CD19FD361JO3F	0.64 (16.3)	0.51 (13.0)	0.20 (5.1)	0.344 (8.7)	0.032 (.8)
390	100	CD10FA391JO3F	0.39 (9.9)	0.38 (9.7)	0.22 (5.6)	0.141 (3.6)	0.016 (.4)
390	500	D105F391JO3F	0.39 (9.9)	0.38 (9.7)	0.22 (5.6)	0.141 (3.6)	0.016 (.4)
390	500	CD15FD391JO3F	0.47 (11.9)	0.39 (9.9)	0.21 (5.3)	0.234 (5.9)	0.025 (.6)
390	500	CD19FD391JO3F	0.64 (16.3)	0.51 (13.0)	0.20 (5.1)	0.344 (8.7)	0.032 (.8)

Mica Capacitors, Standard Dipped



Types CD10, D10, CD15, CD19, CD30, CD42, CDV19, CDV30

Cap (pF)	Volts (Vdc)	Catalog Part Number	L (in) (mm)	H (in) (mm)	T (in) (mm)	S (in) (mm)	d (in) (mm)
390	1000	CDV19FF391JO3F	0.65 (16.5)	0.51 (13.0)	0.20 (5.1)	0.344 (8.7)	0.032 (.8)
390	1500	CDV30FH391JO3F	0.77 (19.6)	0.85 (21.6)	0.25 (6.4)	0.438 (11.1)	0.040 (1.0)
400	100	CD10FA401JO3F	0.39 (9.9)	0.38 (9.7)	0.22 (5.6)	0.141 (3.6)	0.016 (.4)
430	500	D105F431JO3F	0.39 (9.9)	0.38 (9.7)	0.22 (5.6)	0.141 (3.6)	0.016 (.4)
430	500	CD15FD431JO3F	0.47 (11.9)	0.39 (9.9)	0.21 (5.3)	0.234 (5.9)	0.025 (.6)
430	500	CD19FD431JO3F	0.64 (16.3)	0.51 (13.0)	0.20 (5.1)	0.344 (8.7)	0.032 (.8)
430	1500	CDV30FH431JO3F	0.77 (19.6)	0.85 (21.6)	0.25 (6.4)	0.438 (11.1)	0.040 (1.0)
470	500	D105F471JO3F	0.39 (9.9)	0.38 (9.7)	0.22 (5.6)	0.141 (3.6)	0.016 (.4)
470	500	CD15FD471JO3F	0.47 (11.9)	0.40 (10.2)	0.22 (5.6)	0.234 (5.9)	0.025 (.6)
470	500	CD19FD471JO3F	0.64 (16.3)	0.51 (13.0)	0.20 (5.1)	0.344 (8.7)	0.032 (.8)
470	1500	CDV30FH471JO3F	0.77 (19.6)	0.85 (21.6)	0.25 (6.4)	0.438 (11.1)	0.040 (1.0)
470	2000	CDV30FJ471JO3F	0.77 (19.6)	0.87 (22.1)	0.26 (6.6)	0.438 (11.1)	0.040 (1.0)
470	2,500	CDV30FK471JO3F	0.78 (19.8)	0.87 (22.1)	0.27 (6.9)	0.438 (11.1)	0.040 (1.0)
500	500	D105F501JO3F	0.39 (9.9)	0.38 (9.7)	0.22 (5.6)	0.141 (3.6)	0.016 (.4)
500	500	CD15FD501JO3F	0.47 (11.9)	0.40 (10.2)	0.22 (5.6)	0.234 (5.9)	0.025 (.6)
500	500	CD19FD501JO3F	0.64 (16.3)	0.51 (13.0)	0.20 (5.1)	0.344 (8.7)	0.032 (.8)
500	1500	CDV30FH501JO3F	0.77 (19.6)	0.85 (21.6)	0.25 (6.4)	0.438 (11.1)	0.040 (1.0)
500	2000	CDV30FJ501JO3F	0.77 (19.6)	0.87 (22.1)	0.26 (6.6)	0.438 (11.1)	0.040 (1.0)
500	2,500	CDV30FK501JO3F	0.78 (19.8)	0.87 (22.1)	0.27 (6.9)	0.438 (11.1)	0.040 (1.0)
510	500	D105F511JO3F	0.39 (9.9)	0.38 (9.7)	0.22 (5.6)	0.141 (3.6)	0.016 (.4)
510	500	CD15FD511JO3F	0.47 (11.9)	0.40 (10.2)	0.22 (5.6)	0.234 (5.9)	0.025 (.6)
510	500	CD19FD511JO3F	0.65 (16.5)	0.51 (13.0)	0.20 (5.1)	0.344 (8.7)	0.032 (.8)
510	1500	CDV30FH511JO3F	0.77 (19.6)	0.85 (21.6)	0.25 (6.4)	0.438 (11.1)	0.040 (1.0)
510	2000	CDV30FJ511JO3F	0.77 (19.6)	0.87 (22.1)	0.26 (6.6)	0.438 (11.1)	0.040 (1.0)
510	2,500	CDV30FK511JO3F	0.78 (19.8)	0.87 (22.1)	0.27 (6.9)	0.438 (11.1)	0.040 (1.0)
560	300	D1O3F561JO3F	0.39 (9.9)	0.38 (9.7)	0.22 (5.6)	0.141 (3.6)	0.016 (.4)
560	300	CD15FC561JO3F	0.46 (11.7)	0.38 (9.7)	0.21 (5.3)	0.234 (5.9)	0.025 (.6)
560	500	CD19FD561JO3F	0.65 (16.5)	0.51 (13.0)	0.20 (5.1)	0.344 (8.7)	0.032 (.8)
560	1000	CDV19FF561JO3F	0.65 (16.5)	0.51 (13.0)	0.21 (5.3)	0.344 (8.7)	0.032 (.8)
560	1000	CDV30FF561JO3F	0.77 (19.6)	0.85 (21.6)	0.25 (6.4)	0.438 (11.1)	0.040 (1.0)
560	1500	CDV30FH561JO3F	0.77 (19.6)	0.85 (21.6)	0.25 (6.4)	0.438 (11.1)	0.040 (1.0)
560	2000	CDV30FJ561JO3F	0.77 (19.6)	0.87 (22.1)	0.26 (6.6)	0.438 (11.1)	0.040 (1.0)
560	2500	CDV30FK561JO3F	0.78 (19.8)	0.87 (22.1)	0.27 (6.9)	0.438 (11.1)	0.040 (1.0)
620	300	D1O3F621JO3F	0.39 (9.9)	0.38 (9.7)	0.22 (5.6)	0.141 (3.6)	0.016 (.4)
620	300	CD15FC621JO3F	0.46 (11.7)	0.38 (9.7)	0.21 (5.3)	0.234 (5.9)	0.025 (.6)
620	500	CD19FD621JO3F	0.65 (16.5)	0.51 (13.0)	0.20 (5.1)	0.344 (8.7)	0.032 (.8)
620	1500	CDV30FH621JO3F	0.77 (19.6)	0.85 (21.6)	0.25 (6.4)	0.438 (11.1)	0.040 (1.0)
620	2000	CDV30FJ621JO3F	0.77 (19.6)	0.87 (22.1)	0.26 (6.6)	0.438 (11.1)	0.040 (1.0)
620	2,500	CDV30FK621JO3F	0.78 (19.8)	0.87 (22.1)	0.27 (6.9)	0.438 (11.1)	0.040 (1.0)
680	300	D1O3F681JO3F	0.39 (9.9)	0.38 (9.7)	0.22 (5.6)	0.141 (3.6)	0.016 (.4)
680	300	CD15FC681JO3F	0.47 (11.9)	0.39 (9.9)	0.21 (5.3)	0.234 (5.9)	0.025 (.6)
680	500	CD19FD681JO3F	0.65 (16.5)	0.51 (13.0)	0.21 (5.3)	0.344 (8.7)	0.032 (.8)
680	1000	CDV19FF681JO3F	0.66 (16.8)	0.52 (13.2)	0.22 (5.6)	0.344 (8.7)	0.032 (.8)
680	1500	CDV30FH681JO3F	0.77 (19.6)	0.85 (21.6)	0.25 (6.4)	0.438 (11.1)	0.040 (1.0)

Mica Capacitors, Standard Dipped

Types CD10, D10, CD15, CD19, CD30, CD42, CDV19, CDV30

Cap (pF)	Volts (Vdc)	Catalog Part Number	L (in) (mm)	H (in) (mm)	T (in) (mm)	S (in) (mm)	d (in) (mm)
680	2000	CDV30FJ681JO3F	0.77 (19.6)	0.87 (22.1)	0.26 (6.6)	0.438 (11.1)	0.040 (1.0)
680	2500	CDV30FK681JO3F	0.78 (19.8)	0.87 (22.1)	0.27 (6.9)	0.438 (11.1)	0.040 (1.0)
750	300	D1O3F751JO3F	0.39 (9.9)	0.38 (9.7)	0.22 (5.6)	0.141 (3.6)	0.016 (.4)
750	300	CD15FC751JO3F	0.47 (11.9)	0.39 (9.9)	0.21 (5.3)	0.234 (5.9)	0.025 (.6)
750	500	CD19FD751JO3F	0.65 (16.5)	0.51 (13.0)	0.21 (5.3)	0.344 (8.7)	0.032 (.8)
750	1500	CDV30FH751JO3F	0.77 (19.6)	0.85 (21.6)	0.25 (6.4)	0.438 (11.1)	0.040 (1.0)
750	2000	CDV30FJ751JO3F	0.77 (19.6)	0.87 (22.1)	0.26 (6.6)	0.438 (11.1)	0.040 (1.0)
750	2500	CDV30FK751JO3F	0.78 (19.8)	0.87 (22.1)	0.27 (6.9)	0.438 (11.1)	0.040 (1.0)
820	300	D1O3F821JO3F	0.39 (9.9)	0.38 (9.7)	0.22 (5.6)	0.141 (3.6)	0.016 (.4)
820	300	CD15FC821JO3F	0.47 (11.9)	0.39 (9.9)	0.21 (5.3)	0.234 (5.9)	0.025 (.6)
820	500	CD19FD821JO3F	0.65 (16.5)	0.51 (13.0)	0.21 (5.3)	0.344 (8.7)	0.032 (.8)
820	1000	CDV19FF821JO3F	0.66 (16.8)	0.53 (13.5)	0.23 (5.8)	0.344 (8.7)	0.032 (.8)
820	1,500	CDV30FH821JO3F	0.77 (19.6)	0.85 (21.6)	0.25 (6.4)	0.438 (11.1)	0.040 (1.0)
820	2000	CDV30FJ821JO3F	0.77 (19.6)	0.87 (22.1)	0.26 (6.6)	0.438 (11.1)	0.040 (1.0)
820	2500	CDV30FK821JO3F	0.78 (19.8)	0.87 (22.1)	0.27 (6.9)	0.438 (11.1)	0.040 (1.0)
910	100	D101F911JO3F	0.39 (9.9)	0.38 (9.7)	0.22 (5.6)	0.141 (3.6)	0.016 (.4)
910	100	CD15FA911JO3F	0.47 (11.9)	0.40 (10.2)	0.22 (5.6)	0.234 (5.9)	0.025 (.6)
910	500	CD19FD911JO3F	0.65 (16.5)	0.51 (13.0)	0.21 (5.3)	0.344 (8.7)	0.032 (.8)
910	1,000	CDV19FF911JO3F	0.67 (17.0)	0.53 (13.5)	0.24 (6.1)	0.344 (8.7)	0.032 (.8)
910	1500	CDV30FH911JO3F	0.77 (19.6)	0.85 (21.6)	0.25 (6.4)	0.438 (11.1)	0.040 (1.0)
910	2000	CDV30FJ911JO3F	0.78 (19.8)	0.88 (22.4)	0.28 (7.1)	0.438 (11.1)	0.040 (1.0)
910	2,500	CDV30FK911JO3F	0.78 (19.8)	0.87 (22.1)	0.29 (7.4)	0.438 (11.1)	0.040 (1.0)
1000	100	D101F102JO3F	0.39 (9.9)	0.38 (9.7)	0.22 (5.6)	0.141 (3.6)	0.016 (.4)
1000	100	CD15FA102JO3F	0.48 (12.2)	0.40 (10.2)	0.23 (5.8)	0.234 (5.9)	0.025 (.6)
1000	500	CD19FD102JO3F	0.65 (16.5)	0.52 (13.2)	0.22 (5.6)	0.344 (8.7)	0.032 (.8)
1000	1000	CDV19FF102JO3F	0.67 (17.0)	0.53 (13.5)	0.25 (6.4)	0.344 (8.7)	0.032 (.8)
1000	1500	CDV30FH102JO3F	0.77 (19.6)	0.86 (21.8)	0.26 (6.6)	0.438 (11.1)	0.040 (1.0)
1000	2000	CDV30FJ102JO3F	0.78 (19.8)	0.88 (22.4)	0.28 (7.1)	0.438 (11.1)	0.040 (1.0)
1000	2500	CDV30FK102JO3F	0.79 (20.1)	0.88 (22.4)	0.31 (7.9)	0.438 (11.1)	0.040 (1.0)
1100	100	D101F112JO3F	0.39 (9.9)	0.38 (9.7)	0.22 (5.6)	0.141 (3.6)	0.016 (.4)
1100	100	CD15FA112JO3F	0.49 (12.4)	0.42 (10.7)	0.24 (6.1)	0.234 (5.9)	0.025 (.6)
1100	500	CD19FD112JO3F	0.65 (16.5)	0.52 (13.2)	0.22 (5.6)	0.344 (8.7)	0.032 (.8)
1100	1000	CDV19FF112JO3F	0.67 (17.0)	0.53 (13.5)	0.25 (6.4)	0.344 (8.7)	0.032 (.8)
1100	1500	CDV30FH112JO3F	0.77 (19.6)	0.86 (21.8)	0.26 (6.6)	0.438 (11.1)	0.040 (1.0)
1200	100	D101F122JO3F	0.39 (9.9)	0.38 (9.7)	0.22 (5.6)	0.141 (3.6)	0.016 (.4)
1200	100	CD15FA122JO3F	0.49 (12.4)	0.42 (10.7)	0.24 (6.1)	0.234 (5.9)	0.025 (.6)
1200	500	CD19FD122JO3F	0.66 (16.8)	0.52 (13.2)	0.22 (5.6)	0.344 (8.7)	0.032 (.8)
1200	1,500	CDV30FH122JO3F	0.77 (19.6)	0.86 (21.8)	0.26 (6.6)	0.438 (11.1)	0.040 (1.0)
1200	2000	CDV30FJ122JO3F	0.78 (19.8)	0.88 (22.4)	0.28 (7.1)	0.438 (11.1)	0.040 (1.0)
1200	2500	CDV30FK122JO3F	0.79 (20.1)	0.88 (22.4)	0.31 (7.9)	0.438 (11.1)	0.040 (1.0)
1300	100	D101F132JO3F	0.39 (9.9)	0.38 (9.7)	0.22 (5.6)	0.141 (3.6)	0.016 (.4)
1300	500	CD19FD132JO3F	0.66 (16.8)	0.52 (13.2)	0.22 (5.6)	0.344 (8.7)	0.032 (.8)
1300	1000	CDV19FF132JO3F	0.67 (17.0)	0.54 (13.7)	0.26 (6.6)	0.344 (8.7)	0.032 (.8)

Mica Capacitors, Standard Dipped

Types CD10, D10, CD15, CD19, CD30, CD42, CDV19, CDV30



Cap (pF)	Volts (Vdc)	Catalog Part Number	L (in) (mm)	H (in) (mm)	T (in) (mm)	S (in) (mm)	d (in) (mm)
1300	1500	CDV30FH132JO3F	0.78 (19.8)	0.87 (22.1)	0.27 (6.9)	0.438 (11.1)	0.040 (1.0)
1300	2000	CDV30FJ132JO3F	0.78 (19.8)	0.88 (22.4)	0.30 (7.6)	0.438 (11.1)	0.040 (1.0)
1300	2500	CDV30FK132JO3F	0.80 (20.3)	0.89 (22.6)	0.33 (8.4)	0.438 (11.1)	0.040 (1.0)
1500	100	D101F152JO3F	0.39 (9.9)	0.38 (9.7)	0.22 (5.6)	0.141 (3.6)	0.016 (.4)
1500	100	CD15FA152JO3F	0.50 (12.7)	0.43 (10.9)	0.25 (6.4)	0.234 (5.9)	0.025 (.6)
1500	500	CD19FD152JO3F	0.66 (16.8)	0.52 (13.2)	0.23 (5.8)	0.344 (8.7)	0.032 (.8)
1500	1000	CDV19FF152JO3F	0.68 (17.3)	0.54 (13.7)	0.27 (6.9)	0.344 (8.7)	0.032 (.8)
1500	1500	CDV30FH152JO3F	0.78 (19.8)	0.87 (22.1)	0.28 (7.1)	0.438 (11.1)	0.040 (1.0)
1500	2000	CDV30FJ152JO3F	0.79 (20.1)	0.89 (22.6)	0.32 (8.1)	0.438 (11.1)	0.040 (1.0)
1500	2,500	CDV30FK152JO3F	0.80 (20.3)	0.89 (22.6)	0.35 (8.9)	0.438 (11.1)	0.040 (1.0)
1600	500	CD19FD162JO3F	0.66 (16.8)	0.53 (13.5)	0.23 (5.8)	0.344 (8.7)	0.032 (.8)
1600	1000	CDV19FF162JO3F	0.68 (17.3)	0.55 (14.0)	0.28 (7.1)	0.344 (8.7)	0.032 (.8)
1600	1,500	CDV30FH162JO3F	0.78 (19.8)	0.87 (22.1)	0.28 (7.1)	0.438 (11.1)	0.040 (1.0)
1600	2000	CDV30FJ162JO3F	0.79 (20.1)	0.89 (22.6)	0.32 (8.1)	0.438 (11.1)	0.040 (1.0)
1600	2500	CDV30FK162JO3F	0.80 (20.3)	0.89 (22.6)	0.35 (8.9)	0.438 (11.1)	0.040 (1.0)
1800	500	CD19FD182JO3F	0.67 (17.0)	0.53 (13.5)	0.24 (6.1)	0.344 (8.7)	0.032 (.8)
1800	1000	CDV19FF182JO3F	0.68 (17.3)	0.55 (14.0)	0.29 (7.4)	0.344 (8.7)	0.032 (.8)
1800	1500	CDV30FH182JO3F	0.78 (19.8)	0.87 (22.1)	0.29 (7.4)	0.438 (11.1)	0.040 (1.0)
1800	2,000	CDV30FJ182JO3F	0.79 (20.1)	0.89 (22.6)	0.34 (8.6)	0.438 (11.1)	0.040 (1.0)
1800	2500	CDV30FK182JO3F	0.81 (20.6)	0.90 (22.9)	0.37 (9.4)	0.438 (11.1)	0.040 (1.0)
2000	500	CD19FD202JO3F	0.67 (17.0)	0.53 (13.5)	0.24 (6.1)	0.344 (8.7)	0.032 (.8)
2000	500	CD30FD202JO3F	0.77 (19.6)	0.85 (21.6)	0.24 (6.1)	0.438 (11.1)	0.040 (1.0)
2000	1000	CDV19FF202JO3F	0.68 (17.3)	0.56 (14.2)	0.30 (7.6)	0.344 (8.7)	0.032 (.8)
2000	1500	CDV30FH202JO3F	0.78 (19.8)	0.87 (22.1)	0.30 (7.6)	0.438 (11.1)	0.040 (1.0)
2100	2,000	CDV30FJ212JO3F	0.80 (20.3)	0.90 (22.9)	0.36 (9.1)	0.438 (11.1)	0.040 (1.0)
2100	2500	CDV30FK212JO3F	0.82 (20.8)	0.91 (23.1)	0.39(9.9)	0.438 (11.1)	0.040 (1.0)
2200	500	CD19FD222JO3F	0.67 (17.0)	0.53 (13.5)	0.25(6.4)	0.344 (8.7)	0.032 (.8)
2200	500	CD30FD222JO3F	0.77 (19.6)	0.85 (21.6)	0.25(6.4)	0.438 (11.1)	0.040 (1.0)
2200	1000	CDV19FF222JO3F	0.69 (17.5)	0.56 (14.2)	0.31(7.9)	0.344 (8.7)	0.032 (.8)
2200	1500	CDV30FH222JO3F	0.79 (20.1)	0.88 (22.4)	0.31(7.9)	0.438 (11.1)	0.040 (1.0)
2400	500	CD19FD242JO3F	0.67 (17.0)	0.54 (13.7)	0.26(6.6)	0.344 (8.7)	0.032 (.8)
2400	500	CD30FD242JO3F	0.77 (19.6)	0.85 (21.6)	0.25(6.4)	0.438 (11.1)	0.040 (1.0)
2400	1000	CDV19FF242JO3F	0.69 (17.5)	0.57 (14.5)	0.32(8.1)	0.344 (8.7)	0.032 (.8)
2400	1500	CDV30FH242JO3F	0.79 (20.1)	0.88 (22.4)	0.32(8.1)	0.438 (11.1)	0.040 (1.0)
2400	2,000	CDV30FJ242JO3F	0.80 (20.3)	0.90 (22.9)	0.38(9.7)	0.438 (11.1)	0.040 (1.0)
2400	2500	CDV30FK242JO3F	0.82 (20.8)	0.91 (23.1)	0.42(10.7)	0.438 (11.1)	0.040 (1.0)
2500	500	CD19FD252JO3F	0.68 (17.3)	0.54 (13.7)	0.26(6.6)	0.344 (8.7)	0.032 (.8)
2500	500	CD30FD252JO3F	0.77 (19.6)	0.85 (21.6)	0.25(6.4)	0.438 (11.1)	0.040 (1.0)
2500	1500	CDV30FH252JO3F	0.79 (20.1)	0.88 (22.4)	0.32(8.1)	0.438 (11.1)	0.040 (1.0)
2500	2000	CDV30FJ252JO3F	0.80 (20.3)	0.90 (22.9)	0.38(9.7)	0.438 (11.1)	0.040 (1.0)
2500	2,500	CDV30FK252JO3F	0.82 (20.8)	0.91 (23.1)	0.42(10.7)	0.438 (11.1)	0.040 (1.0)
2700	500	CD19FD272JO3F	0.68 (17.3)	0.54 (13.7)	0.27(6.9)	0.344 (8.7)	0.032 (.8)
2700	500	CD30FD272JO3F	0.77 (19.6)	0.85 (21.6)	0.25(6.4)	0.438 (11.1)	0.040 (1.0)

Mica Capacitors, Standard Dipped

Types CD10, D10, CD15, CD19, CD30, CD42, CDV19, CDV30



Cap (pF)	Volts (Vdc)	Catalog Part Number	L (in) (mm)	H (in) (mm)	T (in) (mm)	S (in) (mm)	d (in) (mm)
2700	1000	CDV19FF272JO3F	0.70 (17.8)	0.57 (14.5)	0.34(8.6)	0.344 (8.7)	0.032 (.8)
2700	1500	CDV30FH272JO3F	0.79 (20.1)	0.88 (22.4)	0.33(8.4)	0.438 (11.1)	0.040 (1.0)
2700	2000	CDV30FJ272JO3F	0.81 (20.6)	0.91 (23.1)	0.40(10.2)	0.438 (11.1)	0.040 (1.0)
2700	2500	CDV30FK272JO3F	0.83 (21.1)	0.92 (23.4)	0.45(11.4)	0.438 (11.1)	0.040 (1.0)
3000	500	CD19FD302JO3F	0.68 (17.3)	0.55 (14.0)	0.28(7.1)	0.344 (8.7)	0.032 (.8)
3000	500	CD30FD302JO3F	0.77 (19.6)	0.86 (21.8)	0.25(6.4)	0.438 (11.1)	0.040 (1.0)
3000	1000	CDV19FF302JO3F	0.71 (18.0)	0.58 (14.7)	0.36(9.1)	0.344 (8.7)	0.032 (.8)
3000	1500	CDV30FH302JO3F	0.80 (20.3)	0.89 (22.6)	0.34(8.6)	0.438 (11.1)	0.040 (1.0)
3000	2000	CDV30FJ302JO3F	0.81 (20.6)	0.91 (23.1)	0.42(10.7)	0.438 (11.1)	0.040 (1.0)
3000	2,500	CDV30FK302JO3F	0.84 (21.3)	0.93 (23.6)	0.48(12.2)	0.438 (11.1)	0.040 (1.0)
3300	500	CD19FD332JO3F	0.68 (17.3)	0.55 (14.0)	0.29(7.4)	0.344 (8.7)	0.032 (.8)
3300	500	CD30FD332JO3F	0.77 (19.6)	0.86 (21.8)	0.25(6.4)	0.438 (11.1)	0.040 (1.0)
3300	1,000	CDV19FF332JO3F	0.72 (18.3)	0.59 (15.0)	0.38(9.7)	0.344 (8.7)	0.032 (.8)
3300	1500	CDV30FH332JO3F	0.80 (20.3)	0.89 (22.6)	0.35(8.9)	0.438 (11.1)	0.040 (1.0)
3300	2000	CDV30FJ332JO3F	0.82 (20.8)	0.92 (23.4)	0.44(11.2)	0.438 (11.1)	0.040 (1.0)
3600	500	CD19FD362JO3F	0.68 (17.3)	0.56 (14.2)	0.30(7.6)	0.344 (8.7)	0.032 (.8)
3600	500	CD30FD362JO3F	0.77 (19.6)	0.86 (21.8)	0.26(6.6)	0.438 (11.1)	0.040 (1.0)
3600	1000	CDV19FF362JO3F	0.73 (18.5)	0.60 (15.2)	0.40(10.2)	0.344 (8.7)	0.032 (.8)
3600	1000	CDV30FF362JO3F	0.80 (20.3)	0.89 (22.6)	0.35(8.9)	0.438 (11.1)	0.040 (1.0)
3600	1,500	CDV30FH362JO3F	0.80 (20.3)	0.89 (22.6)	0.35(8.9)	0.438 (11.1)	0.040 (1.0)
3600	2000	CDV30FJ362JO3F	0.82 (20.8)	0.92 (23.4)	0.44(11.2)	0.438 (11.1)	0.040 (1.0)
3900	500	CD19FD392JO3F	0.69 (17.5)	0.56 (14.2)	0.31(7.9)	0.344 (8.7)	0.032 (.8)
3900	500	CD30FD392JO3F	0.77 (19.6)	0.86 (21.8)	0.26(6.6)	0.438 (11.1)	0.040 (1.0)
3900	1000	CDV19FF392JO3F	0.74 (18.8)	0.61 (15.5)	0.42(10.7)	0.344 (8.7)	0.032 (.8)
3900	1500	CDV30FH392JO3F	0.80 (20.3)	0.89 (22.6)	0.36(9.1)	0.438 (11.1)	0.040 (1.0)
3900	2,000	CDV30FJ392JO3F	0.83 (21.1)	0.93 (23.6)	0.46(11.7)	0.438 (11.1)	0.040 (1.0)
4300	500	CD19FD432JO3F	0.69 (17.5)	0.57 (14.5)	0.33(8.4)	0.344 (8.7)	0.032 (.8)
4300	500	CD30FD432JO3F	0.78 (19.8)	0.86 (21.8)	0.27(6.9)	0.438 (11.1)	0.040 (1.0)
4300	1000	CDV19FF432JO3F	0.75 (19.1)	0.62 (15.7)	0.44(11.2)	0.344 (8.7)	0.032 (.8)
4300	1500	CDV30FH432JO3F	0.81 (20.6)	0.90 (22.9)	0.37(9.4)	0.438 (11.1)	0.040 (1.0)
4300	2000	CDV30FJ432JO3F	0.84 (21.3)	0.93 (23.6)	0.48(12.2)	0.438 (11.1)	0.040 (1.0)
4700	500	CD19FD472JO3F	0.70 (17.8)	0.58 (14.7)	0.35(8.9)	0.344 (8.7)	0.032 (.8)
4700	500	CD30FD472JO3F	0.78 (19.8)	0.86 (21.8)	0.27(6.9)	0.438 (11.1)	0.040 (1.0)
4700	1000	CDV19FF472JO3F	0.76 (19.3)	0.63 (16.0)	0.46(11.7)	0.344 (8.7)	0.032 (.8)
4700	1500	CDV30FH472JO3F	0.81 (20.6)	0.90 (22.9)	0.38(9.7)	0.438 (11.1)	0.040 (1.0)
5000	500	CD19FD502JO3F	0.71 (18.0)	0.59 (15.0)	0.37(9.4)	0.344 (8.7)	0.032 (.8)
5000	500	CD30FD502JO3F	0.78 (19.8)	0.86 (21.8)	0.28(7.1)	0.438 (11.1)	0.040 (1.0)
5000	1500	CDV30FH502JO3F	0.81 (20.6)	0.90 (22.9)	0.38(9.7)	0.438 (11.1)	0.040 (1.0)
5100	500	CD19FD512JO3F	0.71 (18.0)	0.59 (15.0)	0.37(9.4)	0.344 (8.7)	0.032 (.8)
5100	500	CD30FD512JO3F	0.78 (19.8)	0.86 (21.8)	0.28(7.1)	0.438 (11.1)	0.040 (1.0)
5100	1000	CDV30FF512JO3F	0.79 (20.1)	0.88 (22.4)	0.33(8.4)	0.438 (11.1)	0.040 (1.0)
5100	1,500	CDV30FH512JO3F	0.81 (20.6)	0.90 (22.9)	0.39(9.9)	0.438 (11.1)	0.040 (1.0)
5600	300	CD19FC562JO3F	0.68 (17.3)	0.56 (14.2)	0.31(7.9)	0.344 (8.7)	0.032 (.8)
5600	500	CD30FD562JO3F	0.78 (19.8)	0.87 (22.1)	0.29(7.4)	0.438 (11.1)	0.040 (1.0)

Mica Capacitors, Standard Dipped

Types CD10, D10, CD15, CD19, CD30, CD42, CDV19, CDV30

Cap (pF)	Volts (Vdc)	Catalog Part Number	L (in) (mm)	H (in) (mm)	T (in) (mm)	S (in) (mm)	d (in) (mm)
5600	1000	CDV30FF562JO3F	0.80 (20.3)	0.89 (22.6)	0.34(8.6)	0.438 (11.1)	0.040 (1.0)
5600	1500	CDV30FH562JO3F	0.82 (20.8)	0.91 (23.1)	0.40(10.2)	0.438 (11.1)	0.040 (1.0)
6200	300	CD19FC622JO3F	0.69 (17.5)	0.56 (14.2)	0.32(8.1)	0.344 (8.7)	0.032 (.8)
6800	300	CD19FC682JO3F	0.69 (17.5)	0.57 (14.5)	0.33(8.4)	0.344 (8.7)	0.032 (.8)
6200	500	CD30FD622JO3F	0.78 (19.8)	0.87 (22.1)	0.29(7.4)	0.438 (11.1)	0.040 (1.0)
6200	1000	CDV30FF622JO3F	0.80 (20.3)	0.89 (22.6)	0.35(8.9)	0.438 (11.1)	0.040 (1.0)
6200	1500	CDV30FH622JO3F	0.82 (20.8)	0.91 (23.1)	0.41(10.4)	0.438 (11.1)	0.040 (1.0)
6800	500	CD30FD682JO3F	0.78 (19.8)	0.88 (22.4)	0.30(7.6)	0.438 (11.1)	0.040 (1.0)
6800	1000	CDV30FF682JO3F	0.80 (20.3)	0.89 (22.6)	0.36(9.1)	0.438 (11.1)	0.040 (1.0)
6800	1,500	CDV30FH682JO3F	0.83 (21.1)	0.92 (23.4)	0.42(10.7)	0.438 (11.1)	0.040 (1.0)
7500	100	CD19FA752JO3F	0.70 (17.8)	0.57 (14.5)	0.34(8.6)	0.344 (8.7)	0.032 (.8)
7500	500	CD30FD752JO3F	0.79 (20.1)	0.88 (22.4)	0.31(7.9)	0.438 (11.1)	0.040 (1.0)
7500	1,000	CDV30FF752JO3F	0.81 (20.6)	0.89 (22.6)	0.37(9.4)	0.438 (11.1)	0.040 (1.0)
7500	1500	CDV30FH752JO3F	0.83 (21.1)	0.92 (23.4)	0.42(10.7)	0.438 (11.1)	0.040 (1.0)
8200	100	CD19FA822JO3F	0.70 (17.8)	0.58 (14.7)	0.35(8.9)	0.344 (8.7)	0.032 (.8)
8200	500	CD30FD822JO3F	0.79 (20.1)	0.88 (22.4)	0.32(8.1)	0.438 (11.1)	0.040 (1.0)
8200	1000	CDV30FF822JO3F	0.81 (20.6)	0.90 (22.9)	0.39(9.9)	0.438 (11.1)	0.040 (1.0)
8200	1500	CDV30FH822JO3F	0.84 (21.3)	0.93 (23.6)	0.46(11.7)	0.438 (11.1)	0.040 (1.0)
9100	100	CD19FA912JO3F	0.71 (18.0)	0.59 (15.0)	0.36(9.1)	0.344 (8.7)	0.032 (.8)
9100	500	CD30FD912JO3F	0.79 (20.1)	0.88 (22.4)	0.33(8.4)	0.438 (11.1)	0.040 (1.0)
9100	1000	CDV30FF912JO3F	0.82 (20.8)	0.90 (22.9)	0.41(10.4)	0.438 (11.1)	0.040 (1.0)
10000	100	CD19FA103JO3F	0.72 (18.3)	0.60 (15.2)	0.37(9.4)	0.344 (8.7)	0.032 (.8)
10000	500	CD30FD103JO3F	0.80 (20.3)	0.89 (22.6)	0.34(8.6)	0.438 (11.1)	0.040 (1.0)
10000	1000	CDV30FF103JO3F	0.82 (20.8)	0.91 (23.1)	0.42(10.7)	0.438 (11.1)	0.040 (1.0)
11000	500	CD30FD113JO3F	0.80 (20.3)	0.89 (22.6)	0.35(8.9)	0.438 (11.1)	0.040 (1.0)
11000	1000	CDV30FF113JO3F	0.83 (21.1)	0.91 (23.1)	0.44(11.2)	0.438 (11.1)	0.040 (1.0)
12000	500	CD30FD123JO3F	0.80 (20.3)	0.89 (22.6)	0.36(9.1)	0.438 (11.1)	0.040 (1.0)
12000	1000	CDV30FF123JO3F	0.83 (21.1)	0.92 (23.4)	0.46(11.7)	0.438 (11.1)	0.040 (1.0)
13000	500	CD30FD133JO3F	0.81 (20.6)	0.89 (22.6)	0.37(9.4)	0.438 (11.1)	0.040 (1.0)
13000	1000	CDV30FF133JO3F	0.84 (21.3)	0.93 (23.6)	0.48(12.2)	0.438 (11.1)	0.040 (1.0)
15000	500	CD30FD153JO3F	0.81 (20.6)	0.90 (22.9)	0.39(9.9)	0.438 (11.1)	0.040 (1.0)
16000	500	CD30FD163JO3F	0.82 (20.8)	0.90 (22.9)	0.41(10.4)	0.438 (11.1)	0.040 (1.0)
18000	500	CD30FD183JO3F	0.82 (20.8)	0.91 (23.1)	0.43(10.9)	0.438 (11.1)	0.040 (1.0)
20000	500	CD30FD203JO3F	0.83 (21.1)	0.92 (23.4)	0.45(11.4)	0.438 (11.1)	0.040 (1.0)
20000	500	CD42FD203JO3F	1.42 (36.1)	0.87 (22.1)	0.30(7.6)	1.063 (27.0)	0.040 (1.0)
22000	500	CD30FD223JO3F	0.83 (21.1)	0.93 (23.6)	0.46(11.7)	0.438 (11.1)	0.040 (1.0)
22000	500	CD42FD223JO3F	1.42 (36.1)	0.88 (22.4)	0.31(7.9)	1.063 (27.0)	0.040 (1.0)
24000	300	CD30FC243JO3F	0.82 (20.8)	0.90 (22.9)	0.41(10.4)	0.438 (11.1)	0.040 (1.0)
24000	500	CD42FD243JO3F	1.43 (36.3)	0.88 (22.4)	0.32(8.1)	1.063 (27.0)	0.040 (1.0)
25000	300	CD30FC253JO3F	0.82 (20.8)	0.91 (23.1)	0.43(10.9)	0.438 (11.1)	0.040 (1.0)
25000	500	CD42FD253JO3F	1.43 (36.3)	0.88 (22.4)	0.33(8.4)	1.063 (27.0)	0.040 (1.0)
27000	300	CD30FC273JO3F	0.82 (20.8)	0.91 (23.1)	0.43(10.9)	0.438 (11.1)	0.040 (1.0)
27000	500	CD42FD273JO3F	1.43 (36.3)	0.88 (22.4)	0.33(8.4)	1.063 (27.0)	0.040 (1.0)

Mica Capacitors, Standard Dipped



Types CD10, D10, CD15, CD19, CD30, CD42, CDV19, CDV30

Cap (pF)	Volts (Vdc)	Catalog Part Number	L (in) (mm)	H (in) (mm)	T (in) (mm)	S (in) (mm)	d (in) (mm)
30000	300	CD30FC303JO3F	0.83 (21.1)	0.92 (23.4)	0.46(11.7)	0.438 (11.1)	0.040 (1.0)
30000	500	CD42FD303JO3F	1.44 (36.6)	0.89 (22.6)	0.35(8.9)	1.063 (27.0)	0.040 (1.0)
33000	100	CD30FA333JO3F	0.83 (21.1)	0.91 (23.1)	0.44(11.2)	0.438 (11.1)	0.040 (1.0)
33000	500	CD42FD333JO3F	1.44 (36.6)	0.89 (22.6)	0.36(9.1)	1.063 (27.0)	0.040 (1.0)
36000	100	CD30FA363JO3F	0.83 (21.1)	0.92 (23.4)	0.45(11.4)	0.438 (11.1)	0.040 (1.0)
36000	500	CD42FD363JO3F	1.45 (36.8)	0.90 (22.9)	0.38(9.7)	1.063 (27.0)	0.040 (1.0)
39000	500	CD42FD393JO3F	1.45 (36.8)	0.90 (22.9)	0.40(10.2)	1.063 (27.0)	0.040 (1.0)
40000	100	CD30FA403JO3F	0.84 (21.3)	0.92 (23.4)	0.47(11.9)	0.438 (11.1)	0.040 (1.0)
43000	500	CD42FD433JO3F	1.46 (37.1)	0.91 (23.1)	0.42(10.7)	1.063 (27.0)	0.040 (1.0)
47000	500	CD42FD473JO3F	1.47 (37.3)	0.91 (23.1)	0.45(11.4)	1.063 (27.0)	0.040 (1.0)
50000	500	CD42FD503JO3F	1.48 (37.6)	0.92 (23.4)	0.47(11.9)	1.063 (27.0)	0.040 (1.0)
51000	500	CD42FD513JO3F	1.48 (37.6)	0.92 (23.4)	0.47(11.9)	1.063 (27.0)	0.040 (1.0)
56000	300	CD42FC563JO3F	1.46 (37.1)	0.91 (23.1)	0.42(10.7)	1.063 (27.0)	0.040 (1.0)
62000	300	CD42FC623JO3F	1.47 (37.3)	0.92 (23.4)	0.45(11.4)	1.063 (27.0)	0.040 (1.0)
68000	300	CD42FC683JO3F	1.48 (37.6)	0.92 (23.4)	0.47(11.9)	1.063 (27.0)	0.040 (1.0)
75000	100	CD42FA753JO3F	1.47 (37.3)	0.91 (23.1)	0.44(11.2)	1.063 (27.0)	0.040 (1.0)
82000	100	CD42FA823JO3F	1.48 (37.6)	0.92 (23.4)	0.46(11.7)	1.063 (27.0)	0.040 (1.0)
91000	100	CD42FA913JO3F	1.50 (38.1)	0.94 (23.9)	0.50(12.7)	1.063 (27.0)	0.040 (1.0)

Notice and Disclaimer: All product drawings, descriptions, specifications, statements, information and data (collectively, the "Information") in this datasheet or other publication are subject to change. The customer is responsible for checking, confirming and verifying the extent to which the Information contained in this datasheet or other publication is applicable to an order at the time the order is placed. All Information given herein is believed to be accurate and reliable, but it is presented without any guarantee, warranty, representation or responsibility of any kind, expressed or implied. Statements of suitability for certain applications are based on the knowledge that the Cornell Dubilier company providing such statements ("Cornell Dubilier") has of operating conditions that such Cornell Dubilier company regards as typical for such applications, but are not intended to constitute any guarantee, warranty or representation regarding any such matter – and Cornell Dubilier specifically and expressly disclaims any guarantee, warranty or representation concerning the suitability for a specific customer application, use, storage, transportation, or operating environment. The Information is intended for use only by customers who have the requisite experience and capability to determine the correct products for their application. Any technical advice inferred from this Information or otherwise provided by Cornell Dubilier with reference to the use of any Cornell Dubilier products is given gratis (unless otherwise specified by Cornell Dubilier), and Cornell Dubilier assumes no obligation or liability for the advice given or results obtained. Although Cornell Dubilier strives to apply the most stringent quality and safety standards regarding the design and manufacturing of its products, in light of the current state of the art, isolated component failures may still occur. Accordingly, customer applications which require a high degree of reliability or safety should employ suitable designs or other safeguards (such as installation of protective circuitry or redundancies or other appropriate protective measures) in order to ensure that the failure of an electrical component does not result in a risk of personal injury or property damage. Although all product-related warnings, cautions and notes must be observed, the customer should not assume that all safety measures are indicated in such warnings, cautions and notes, or that other safety measures may not be required.

Looking for pricing, stock, or lifecycle information?

Click below to explore more details on WIN SOURCE:

- ⊖ [View CD19FD182FO3F on WIN SOURCE](#)
- ⊖ [Cornell Dubilier Electronics \(CDE\) Information](#)

Optimize Your Supply Chain with WIN SOURCE Solutions

- ✓ Global Sourcing Solution
- ✓ Obsolete Management
- ✓ Cost Control Management
- ✓ Shortage Management
- ✓ Alternative Solution
- ✓ Excess Inventory Management