



THE DATASHEET OF
FS1-Z38-20Z6-10



UltraPort QSFP 1xN cages

Product Specification S6083C Rev 1.0

Amphenol

Now you're connected!

About Amphenol Commercial Products

Amphenol's commercial connector products are used in a variety of end user applications including networking, telecom, server & computer, storage & HDD, consumer electronics and entertainment, professional audio & Industrial & Military/Aerospace.

Related Products

QSFP+



QSFP+ 38 POSITION CONNECTOR

PCI Express

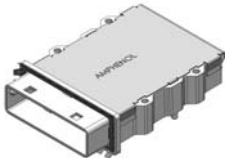

SINGLE 1° CAGE

MiniSAS



26 POSITION CONNECTOR WITH HOLD DOWN TABS



FS1 SINGLE PORT CAGE WITH METAL GASKET

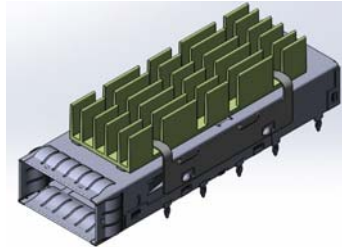

1x1 Cage with Fin heat sink

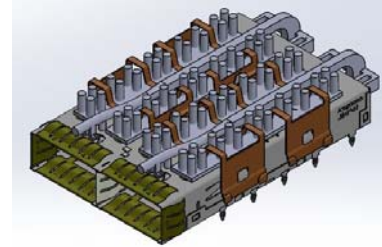

1x2 Cage with round pin heat sinks and single barrel light pipes

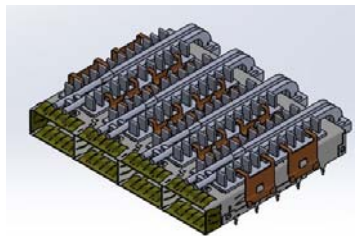

1x4 Cage with pin fin heat sinks and single barrel light pipes

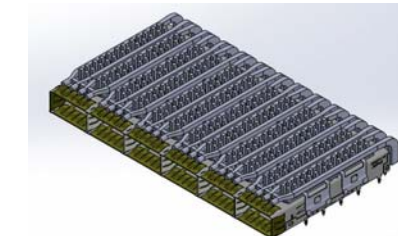

1x6 Cage with square pin heat sinks and quad barrel light pipes

Overview

This short form Product Specification defines the general use and performance parameters for Amphenol's UltraPort QSFP 1xN cage series. It is designed to comply with the Quad Small Form-factor Pluggable (QSFP) SFF-8663 QSFP+ 28Gbps cage specification.

Availability: 1x1, 1x2, 1x3, 1x4 and 1x6 versions are available in thru the bezel configurations. 1x1 One degree cage also available in thru the bezel configuration. Behind bezel and Hybrid versions shall become available soon.

Usage

The UltraPort QSFP single row cages are intended to be used with UltraPort QSFP SMT connector . (Refer to Product spec. S6082C)

Applications

Intended for use in high speed serial interconnect applications such as:

- Cellular hubs
- Switches
- Servers
- Storage devices

Now you're connected!

About Amphenol Commercial Products

Amphenol's commercial connector products are used in a variety of end user applications including networking, telecom, server & computer, storage & HDD, consumer electronics and entertainment, professional audio & Industrial & Military/Aerospace.

Related Products

QSFP+



QSFP+ 38 POSITION CONNECTOR

PCI Express

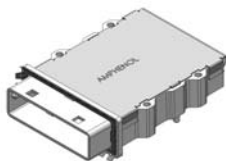

SINGLE 1" CAGE

MiniSAS



26 POSITION CONNECTOR WITH HOLD DOWN TABS

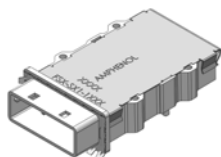

FS1 SINGLE PORT CAGE WITH METAL GASKET

General Requirements

Cages are packaged in trays.

Heat sinks/clips and light pipes are assembled to the cage and placed in the tray if available.

Heat sinks and heat sink clips may be packaged separately for 1x1 options only.

Dust covers are packaged separately if ordered.

"Belly-to-belly" version allows two cages to mount on opposite sides of the PCB.

Cage Mechanical Characteristics

Cages are available with and without Heat Sinks

Cages are available with and without Light Pipes

Cages are press-fit into PCBs

Cages have error proof features according to QSFP MSA

Material Requirements

Unless otherwise specified, the materials for each component shall be:

Cage

- Base material – Phosphor Bronze
- 100 μ " (2.54 μ m) Minimum Nickel plated

Heat Sink

- Base material – Aluminum alloy with Nickel plating

Heat Sink Clip

- Base material – Stainless Steel

Light Pipe

- Base material – Clear Polycarbonate, optical grade

Dust Cover

- Base material – Conductive Rubber

EMI gasket

- Base material – Conductive elastomer

EMI flange

- Base material – Dia cast zinc alloy with Nickel plating

Operating temperature: -40° to +85° C

Storage temperature: -40° to +85° C

Now you're connected!

About Amphenol Commercial Products

Amphenol's commercial connector products are used in a variety of end user applications including networking, telecom, server & computer, storage & HDD, consumer electronics and entertainment, professional audio & Industrial & Military/Aerospace.

Related Products

QSFP+



QSFP+ 38 POSITION CONNECTOR

PCI Express

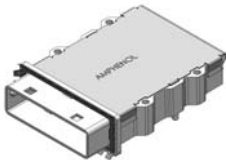

SINGLE 1" CAGE

MiniSAS



26 POSITION CONNECTOR WITH HOLD DOWN TABS



FS1 SINGLE PORT CAGE WITH METAL GASKET

Assembly Instructions

Compliant Pin Holes must be drilled and plated through to specific dimensions to prevent damage during placement of cage assembly on the PCB. See table below.

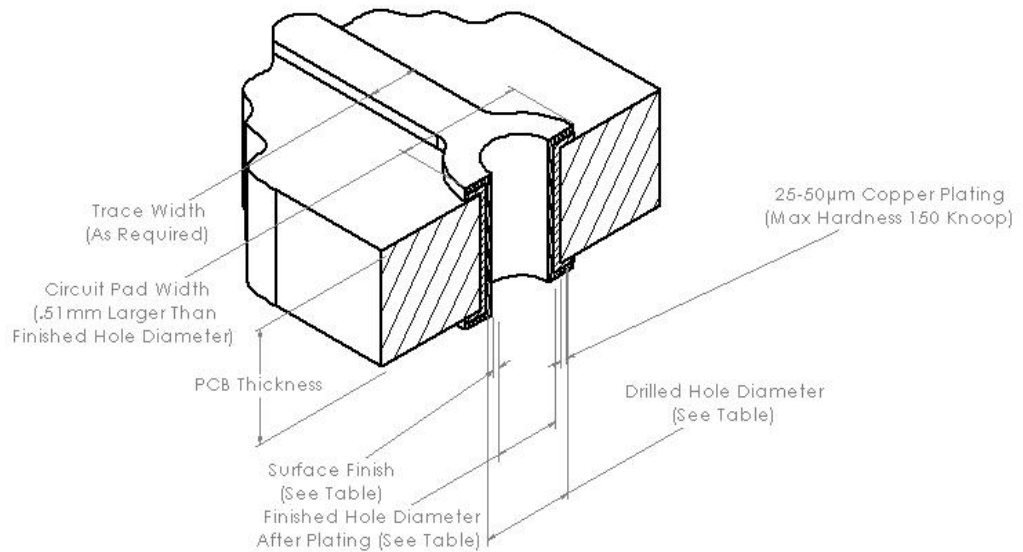

Drawing Not to Scale

Surface Finish	Drilled Hole Diameter	Finished Hole Diameter	Surface Finish Thickness
HASL SnPb	1.15±0.02	1.05 Ref	0.004-0.010
Immersion Sn	1.15±0.02	1.05 Ref	0.0005 Min.
OSP	1.15±0.02	1.05 Ref	0.0002-0.0005
Immersion Au/Ni	1.15±0.02	1.05 Ref	0.004-0.0076 (Ni) 0.0001-0.0005 (Au)

Now you're connected!

About Amphenol Commercial Products

Amphenol's commercial connector products are used in a variety of end user applications including networking, telecom, server & computer, storage & HDD, consumer electronics and entertainment, professional audio & Industrial & Military/Aerospace.

Related Products

QSFP+



QSFP+ 38 POSITION CONNECTOR

PCI Express

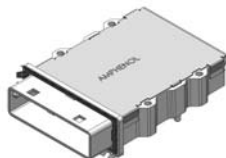

SINGLE 1° CAGE

MiniSAS



26 POSITION CONNECTOR WITH HOLD DOWN TABS



FS1 SINGLE PORT CAGE WITH METAL GASKET

Available Documents

Drawing Numbers:

P-FS1-Z38-X0Z6-10

UltraPort QSFP SMT connector, with resonance dampening feature

P-U95-T(A,L)1X1-1XXX

UltraPort QSFP 1x1 thru the bezel cage, 0 deg. with heat sink and light pipe options

P-U95-T(L)2X1-1XXX

UltraPort QSFP 1x2 thru the bezel cage, 0 deg. with heat sink and light pipe options

P-U95-T(L)3X1-1XXX

UltraPort QSFP 1x3 thru the bezel cage, 0 deg. with heat sink and light pipe options

P-U95-T(L)4X1-1XXX

UltraPort QSFP 1x4 thru the bezel cage, 0 deg. with heat sink and light pipe options

P-U95-T(L)6X1-1XXX

UltraPort QSFP 1x6 thru the bezel cage, 0 deg. with heat sink and light pipe options

P-U95-W1X1-1XXX

UltraPort QSFP 1x1 thru the bezel cage, 1 deg. with heat sink options

P-U95-G(P)1X1-1XXX

UltraPort QSFP 1x1 behind bezel, 0 deg., heat sink and light pipe options-Preliminary

P-U95-G(P)2X1-1XXX

UltraPort QSFP 1x2 behind bezel, 0 deg., heat sink and light pipe options-Preliminary

P-U95-G(P)3X1-1XXX

UltraPort QSFP 1x3 behind bezel, 0 deg., heat sink and light pipe options-Preliminary

P-U95-D(V)1X1-1XXX

UltraPort QSFP 1x1 hybrid cage, 0 deg., heat sink and light pipe options-Preliminary

P-U95-D(V)2X1-1XXX

UltraPort QSFP 1x2 hybrid cage, 0 deg., heat sink and light pipe options-Preliminary

P-U95-D(V)3X1-1XXX

UltraPort QSFP 1x3 hybrid cage, 0 deg., heat sink and light pipe options-Preliminary

P-U95-D(V)4X1-1XXX

UltraPort QSFP 1x4 hybrid cage, 0 deg., heat sink and light pipe options-Preliminary

Contact factory or Authorized Amphenol representative for alternate configurations

Looking for pricing, stock, or lifecycle information?

Click below to explore more details on WIN SOURCE:

 [View FS1-Z38-20Z6-10 on WIN SOURCE](#)

 [Amphenol Information](#)

Optimize Your Supply Chain with WIN SOURCE Solutions

-  Global Sourcing Solution
-  Obsolete Management
-  Cost Control Management
-  Shortage Management
-  Alternative Solution
-  Excess Inventory Management