



Film Capacitors - Power Electronic Capacitors

Series/Type: MKP DC
Ordering code: B2562*
Date: July 2022
Version: 14

1. Construction and general data

| Characteristics | |
|--|--|
| Standard capacitance tolerance | K: $\pm 10\%$ |
| Dielectric dissipation factor ($\tan \delta_o$) | $2 \cdot 10^{-4}$ |
| Service life expectancy (refer to section 3) | 100000 h at $T_{hs} +75\text{ °C}$ and V_{RDC} up to 200000 h (Considering de-ratings in voltage and/or temperature upon request) |
| Expected Fit rate $\alpha_{FQ (co)}$ | 50 fit at V_{RDC} and 70 °C (refer to section 4) |
| Minimum temperature $T_{op,min.}$ | -55 °C |
| Maximum temperature $T_{op,max.}$ | +85 °C for diameter 85 mm +75 °C for diameter 116 mm |
| Storage temperature T_{stg} | $-55 \dots +85\text{ °C}$ |
| Maximum hotspot temperature T_{hs} (refer to section 1) | +85 °C for diameter 85 mm +75 °C for diameter 116 mm |
| Climatic category | 55/85/56 for 85 mm diameter 55/75/56 for 116 mm diameter |
| Maximum altitude | 2000 m above sea level (derating curves for altitudes higher than 2000 m available upon request) |
| Frequency range | 100 Hz \sim 10 kHz for $C_R \leq 1500\text{ }\mu\text{F}$ 100 Hz \sim 5 kHz for $1500\text{ }\mu\text{F} < C_R \leq 3000\text{ }\mu\text{F}$ 100 Hz \sim 3 kHz for $3000\text{ }\mu\text{F} < C_R \leq 4000\text{ }\mu\text{F}$ (High frequency designs available upon request) |
| Safety device | No internal protection |
| Test data | |
| Voltage between terminals V_{TT} | $1.5 V_{RDC}$, 10 s |
| Voltage between terminals and case V_{TC} | $4000 V_{ac}$, 10 s |
| Design data | |
| Resin filling | Non PCB, hard polyurethane (dry type) |
| Mounting and grounding | M12 threaded bolt on bottom of the aluminum case |
| Max. torque (case) M12 stud | 10 Nm |
| Max. torque terminal | Female M6: 5 Nm; Female M8: 6 Nm; Male M8: 8 Nm; |
| Cooling | Naturally air-cooled (or forced air cooling) |
| Degree of protection | IP00 (Indoor mounting) |
| Reference standards | |
| IEC 61071 | |
| RoHS compliance | |
| Certification:UL 810-5 th (refer to table 1.3) certification file No. E183224 | |

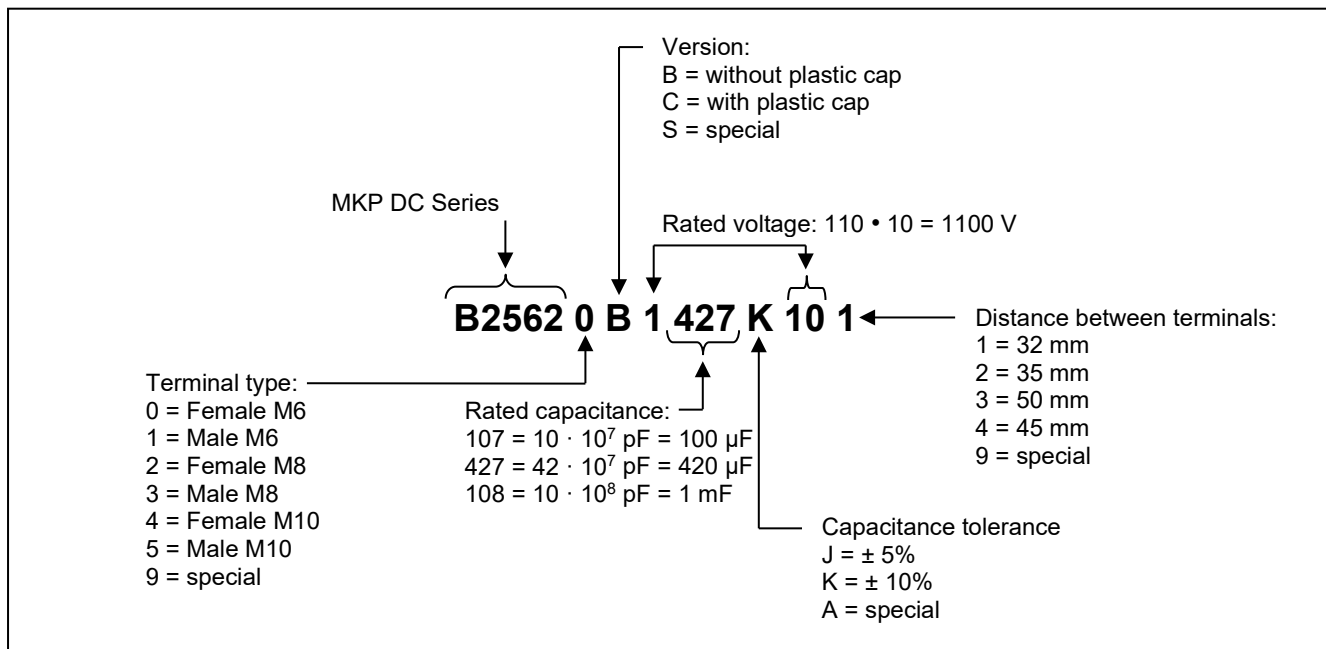
1.1 Structure of ordering code

1.2 Label information

B25620B1427K101

420 μ F $\pm 10\%$

$V_{RDC} = 1100\text{V}$

$V_{TC} = 4\text{kV}$

-55...+85°C IEC 61071

SH-No PCB Dry Type

Discharge before handling

Made by EPCOS 10 Z 2022



The label explanation is following:

10 Z 2022: Production in TDK Electronics Zhuhai factory **2022** year, calendar week **10**;

Bar code consists of lot number and serial number:

- Lot number: 9 digits (ex.: **905887304**)
- Serial number: 3 digits (ex.: **001**)

1.3 Standard types

| Distance between terminals (mm) OC ending | | 32 ± 0.5 - ^{**1} | 50 ± 0.5 - ^{**3} |
|--|-----------------------|----------------------------------|----------------------------------|
| Diameter (Ø) Terminal type | | | |
| 85 mm | Female M6 (B25620) | Standard | |
| 116 mm | Female M6 (B25620) | | Standard |

Other terminal configurations available upon request.

1.4 UL approved types

| Diameter (Ø) | Series |
|--------------|-----------|
| 85 mm | B25620C |
| 116 mm | All types |

1.5 Packing information

| Diameter (Ø) | Packing design |
|--------------|---|
| 85 mm | 4 capacitors per box or 12 capacitors per box |
| 116 mm | 4 capacitors per box |

Each carton box may contain carton plates to fill the empty space, the number of carton plates will be defined by actual demand.

1.6 Dimensional drawings

Figure 1: - B25620B - Ø 85 mm
 - Female terminals (M6)
 - Between terminals 32 ± 0.5 mm

Figure 2: - B25620C - Ø 85 mm
 - Female terminals (M6)
 - Between terminals 32 ± 0.5 mm

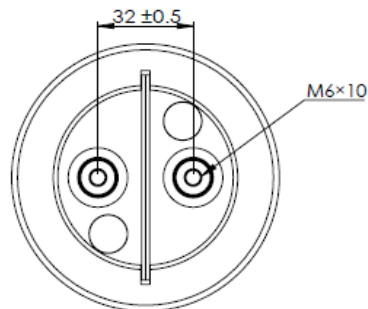
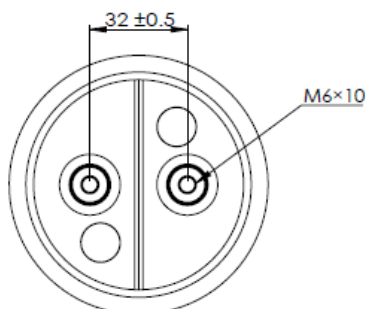
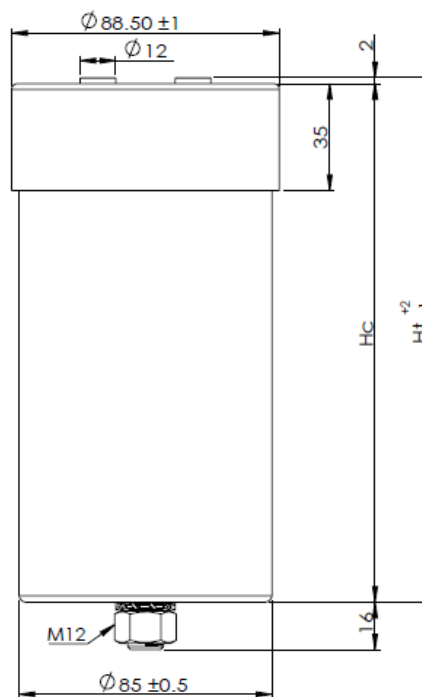
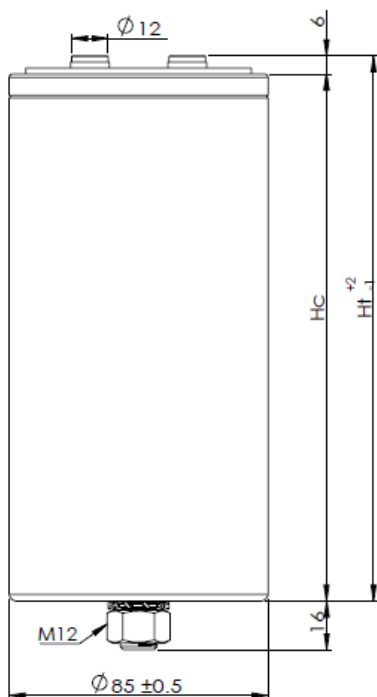

M12 stud on bottom of the aluminum case, nut (DIN 934) and toothed lock washer (DIN 6797) for fixing are standard for all types.

Figure 3: - B25620B - \varnothing 116 mm
 - Female terminals (M6)
 - Between terminals 50 ± 0.5 mm

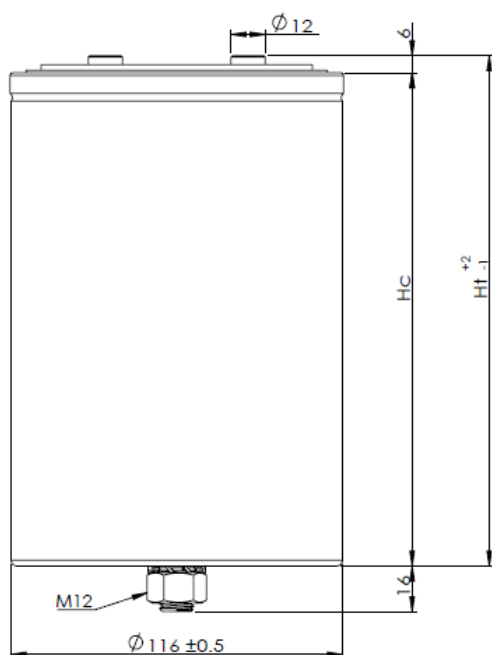
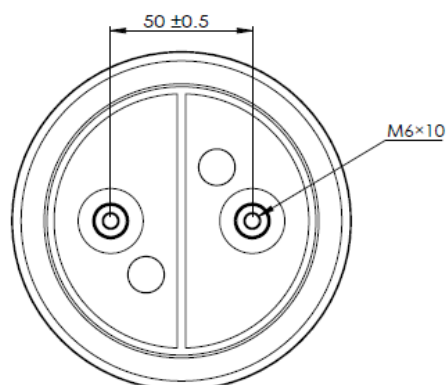
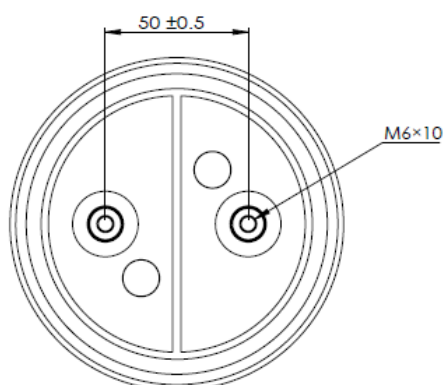
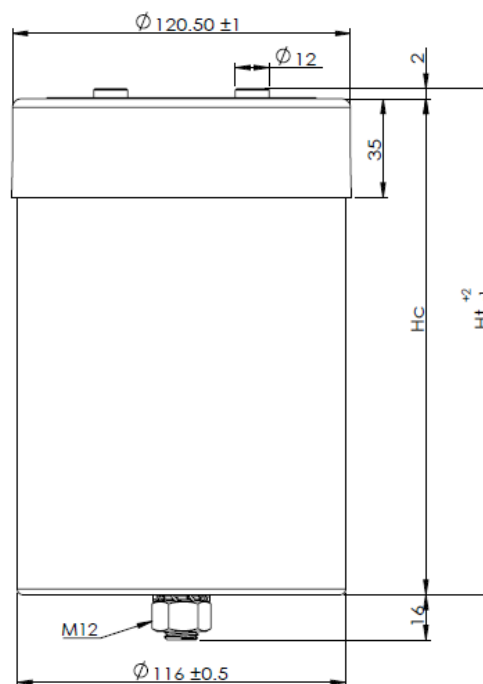

Figure 4: - B25620C - \varnothing 116 mm
 - Female terminals (M6)
 - Between terminals 50 ± 0.5 mm



M12 stud on bottom of the aluminum case, nut (DIN 934) and toothed lock washer (DIN 6797) for fixing are standard for all types.

Terms and characteristics

The following definitions apply to power capacitors according to IEC 61071.

Rated capacitance C_R

Nominal value of the capacitance at 20 °C and measuring frequency of 100 Hz.

Rated DC voltage V_{RDC}

Maximum operating peak voltage of either polarity, but of a non-reversing type wave form, for which the capacitor has been designed, for continuous operation.

Ripple voltage V_{ripple}

Peak-to-peak alternating component of the unidirectional voltage.

This value must not exceed $0.28 \cdot V_{RDC}$

Maximum surge voltage V_s

Peak voltage induced by a switching or any other disturbance of the system which is allowed for a limited number of times and short period.

Insulation voltage V_i

Rms rated value of the insulation voltage of capacitive elements and terminals to case or earth. When it is not specified in the product data sheet, the insulation voltage is at least:

$$V_i = \frac{V_{RDC}}{\sqrt{2}}$$

AC voltage test between terminals and case V_{TC}

Units having all terminals insulated from the container shall be subjected for 10 s to a voltage applied between the terminals (joined together) and the container.

Maximum rate of voltage rise $(dv/dt)_{max}$

Maximum permissible repetitive rate of voltage rise of the operational voltage.

Maximum current I_{max}

Maximum rms current for continuous operation for the given frequency range and for the maximum ripple voltage. Please provide Frequency Spectrum of rms current to your sales contact.

Maximum peak current \hat{I}

Maximum permissible repetitive current amplitude during continuous operation.

Maximum peak current (\hat{I}) and maximum rate of voltage rise $(dv/dt)_{max}$ on a capacitor are related as follows:

$$\hat{I} = C \cdot (dv/dt)_{max}$$

Maximum surge current \hat{I}_s

Admissible peak current induced by a switching or any other disturbance of the system which is allowed for a limited number of times and short period.

$$\hat{I}_s = C \cdot (dv/dt)_s$$

Ambient temperature T_A

Temperature of the surrounding air, measured at 10 cm distance and 2/3 of the case height of the capacitor.

Lowest operating temperature $T_{op,min}$

Lowest permitted ambient temperature at which a capacitor may be energized.

Maximum operating temperature $T_{op,max}$

Highest permitted capacitor temperature during operation, i.e. temperature at the hottest point of the case.

Hot-spot temperature T_{hs}

Temperature zone inside of the capacitor at hottest spot.

$$T_{hs} = T_A + I_{rms}^2 \cdot ESR \cdot R_{th}$$

Tangent of the loss angle of a capacitor $\tan \delta$

Ratio between the equivalent series resistance and the capacitive reactance of a capacitor at a specified sinusoidal alternating voltage, frequency and temperature.

Series resistance R_s

The sum of all Ohmic resistances occurring inside the capacitor.

ESR

ESR (Equivalent Series Resistance) which if connected in series with an ideal capacitor of capacitance value equal to that of the capacitor in question, would have a power loss equal to active power dissipated in that capacitor under specified operating conditions.

$$ESR = \frac{\tan \delta}{\omega \cdot C} = R_s + \frac{\tan \delta_0}{\omega \cdot C}$$

Thermal resistance R_{th}

The thermal resistance indicates by how many degrees the capacitor temperature at the hot spot rises in relation to the dissipation losses.

Maximum power loss P_{max}

Maximum permissible power dissipation for the capacitor's operation.

$$P_{max} = \frac{T_{hs} - T_A}{R_{th}}$$

Self inductance L_{self}

The sum of all inductive elements which are contained in a capacitor.

Resonance frequency f_r

The lowest frequency at which the impedance of the capacitor becomes minimum.

$$f_r = \frac{1}{2\pi \cdot \sqrt{L_{self} \cdot C_R}}$$

$V_{RDC} = 700 \text{ V DC} / V_{TT} = 1050 \text{ V DC}, 10\text{s} / V_{TC} = 4000 \text{ V AC}, 10\text{s}$

| C_R μF | I_{MAX}^1 A | I_s kA | \hat{I} kA | ESR ² m Ω | L_{self} nH | R_{TH} K/W | D mm | H_c^3 mm | H_r mm | Weight ⁴ kg | Fig. | Ordering code |
|------------------------|------------------|-------------|-----------------|--------------------------------|------------------|-----------------|---------|---------------|-------------|---------------------------|------|---------------------------------|
| 280 | 55 | 9.1 | 3 | 1.4 | ≤ 40 | 4 | 85 | 70 | 76 | 0.45 | 1 | B25620B0287K701 |
| 470 | 55 | 8.6 | 2.9 | 1.6 | ≤ 40 | 3.3 | 85 | 95 | 101 | 0.58 | 1 | B25620B0477K701 |
| 560 | 80 | 18.2 | 6 | 1 | ≤ 40 | 2.9 | 116 | 70 | 76 | 0.88 | 3 | B25620B0567K703 |
| 620 | 55 | 9.1 | 3 | 2 | ≤ 40 | 2.9 | 85 | 120 | 126 | 0.71 | 1 | B25620B0627K701 |
| 700 | 55 | 9.1 | 3 | 2.2 | ≤ 40 | 2.8 | 85 | 132 | 138 | 0.84 | 1 | B25620B0707K701 |
| 700 | 55 | 9.1 | 3 | 2.2 | ≤ 40 | 2.8 | 85 | 136 | 138 | 0.87 | 2 | B25620C0707K701 |
| 750 | 70 | 16.9 | 5.6 | 1.4 | ≤ 40 | 2.4 | 85 | 155 | 161 | 1 | 1 | B25620B0757K701 |
| 900 | 80 | 18.2 | 6 | 1 | ≤ 40 | 2.3 | 116 | 95 | 101 | 1.13 | 3 | B25620B0907K703 |
| 950 | 70 | 17.6 | 5.9 | 1.5 | ≤ 60 | 2.1 | 85 | 173 | 179 | 1.1 | 1 | B25620B0957K701 |
| 1240 | 80 | 18.2 | 6.1 | 1.3 | ≤ 40 | 2.2 | 116 | 120 | 126 | 1.4 | 3 | B25620B0128K743 |
| 1300 | 70 | 17.7 | 5.9 | 1.5 | ≤ 60 | 1.9 | 85 | 223 | 229 | 1.4 | 1 | B25620B0138K701 |
| 1400 | 80 | 18.1 | 6 | 1.5 | ≤ 40 | 2.1 | 116 | 132 | 138 | 1.55 | 3 | B25620B0148K703 |
| 1500 | 80 | 33.8 | 11.3 | 0.9 | ≤ 40 | 2.1 | 116 | 155 | 161 | 1.85 | 3 | B25620B0158K703 |
| 1900 | 80 | 34.7 | 11.6 | 1 | ≤ 60 | 2 | 116 | 173 | 179 | 2.05 | 3 | B25620B0198K703 |
| 2600 | 80 | 35.5 | 11.9 | 1.1 | ≤ 60 | 1.8 | 116 | 223 | 229 | 2.56 | 3 | B25620B0268K703 |
| 2900 | 80 | 35.8 | 11.9 | 1.2 | ≤ 90 | 1.8 | 116 | 248 | 254 | 2.85 | 3 | B25620B0298K703 |
| 4000 | 100 | 40.0 | 13.3 | 1.1 | ≤ 100 | 1.4 | 116 | 345 | 351 | 3.95 | 3 | B25620B0408K703 |
| 4000 | 100 | 40.0 | 13.3 | 1.1 | ≤ 100 | 1.4 | 116 | 349 | 351 | 3.99 | 4 | B25620C0408K703 |

¹ Please refer to current derating section for more details

² ESR at 1 kHz (typical value)

³ H_c is typical value

⁴ Weight is typical value

Other configurations and capacitance tolerances available upon request

V_{RDC} = 900 V DC / V_{TT} = 1350V DC, 10s / V_{TC} = 4000 V AC, 10s

| C _R μF | I _{MAX} ¹ A | I _s kA | Ĥ kA | ESR ² mΩ | L _{self} nH | R _{TH} K/W | D mm | H _c ³ mm | H _r mm | Weight ⁴ kg | Fig. | Ordering code |
|----------------------|------------------------------------|----------------------|---------|------------------------|-------------------------|------------------------|---------|-----------------------------------|----------------------|---------------------------|------|---------------------------------|
| 220 | 50 | 8.1 | 2.7 | 1.5 | ≤ 40 | 4 | 85 | 70 | 76 | 0.45 | 1 | B25620B0227K881 |
| 220 | 50 | 8.1 | 2.7 | 1.5 | ≤ 40 | 4 | 85 | 74 | 76 | 0.48 | 2 | B25620C0227K881 |
| 350 | 50 | 8.0 | 2.7 | 1.7 | ≤ 40 | 3.3 | 85 | 95 | 101 | 0.58 | 1 | B25620B0357K881 |
| 350 | 50 | 8.0 | 2.7 | 1.7 | ≤ 40 | 3.3 | 85 | 99 | 101 | 0.61 | 2 | B25620C0357K881 |
| 440 | 65 | 16.3 | 5.4 | 1.1 | ≤ 40 | 2.9 | 116 | 70 | 76 | 0.88 | 3 | B25620B0447K883 |
| 480 | 55 | 8.1 | 2.7 | 2.1 | ≤ 40 | 2.9 | 85 | 120 | 126 | 0.71 | 1 | B25620B0487K881 |
| 480 | 55 | 8.1 | 2.7 | 2.1 | ≤ 40 | 2.9 | 85 | 124 | 126 | 0.74 | 2 | B25620C0487K881 |
| 550 | 50 | 8.3 | 2.8 | 2.3 | ≤ 40 | 2.8 | 85 | 132 | 138 | 0.84 | 1 | B25620B0557K881 |
| 550 | 50 | 8.3 | 2.8 | 2.3 | ≤ 40 | 2.8 | 85 | 136 | 138 | 0.87 | 2 | B25620C0557K881 |
| 600 | 70 | 15.5 | 5.1 | 1.5 | ≤ 40 | 2.4 | 85 | 155 | 161 | 1 | 1 | B25620B0607K881 |
| 700 | 70 | 16.1 | 5.3 | 1.2 | ≤ 40 | 2.3 | 116 | 95 | 101 | 1.13 | 3 | B25620B0707K883 |
| 750 | 75 | 17.3 | 5.8 | 1.6 | ≤ 60 | 2.1 | 85 | 173 | 179 | 1.1 | 1 | B25620B0757K881 |
| 750 | 75 | 17.3 | 5.8 | 1.6 | ≤ 60 | 2.1 | 85 | 177 | 179 | 1.13 | 2 | B25620C0757K881 |
| 900 | 75 | 14.0 | 4.7 | 1.6 | ≤ 60 | 1.9 | 85 | 223 | 229 | 1.4 | 1 | B25620B0907K881 |
| 970 | 75 | 16.3 | 5.4 | 1.4 | ≤ 40 | 2.2 | 116 | 120 | 126 | 1.4 | 3 | B25620B0977K883 |
| 1000 | 80 | 13.7 | 4.6 | 1.7 | ≤ 90 | 1.9 | 85 | 248 | 254 | 1.51 | 1 | B25620B0108K881 |
| 1100 | 80 | 16.3 | 5.4 | 1.5 | ≤ 40 | 2.1 | 116 | 132 | 138 | 1.55 | 3 | B25620B0118K883 |
| 1200 | 80 | 31.0 | 10.3 | 1 | ≤ 40 | 2.1 | 116 | 155 | 161 | 1.85 | 3 | B25620B0128K883 |
| 1500 | 80 | 33.1 | 11 | 1.1 | ≤ 60 | 2 | 116 | 173 | 179 | 2.05 | 3 | B25620B0158K883 |
| 1500 | 80 | 33.1 | 11 | 1.1 | ≤ 60 | 2 | 116 | 177 | 179 | 2.09 | 4 | B25620C0158K883 |
| 2000 | 80 | 33.3 | 11 | 1.2 | ≤ 60 | 1.8 | 116 | 223 | 229 | 2.56 | 3 | B25620B0208K883 |
| 2200 | 80 | 33.3 | 11 | 1.3 | ≤ 90 | 1.8 | 116 | 248 | 254 | 2.85 | 3 | B25620B0228K883 |
| 2900 | 100 | 38.5 | 12.8 | 1.2 | ≤ 100 | 1.4 | 116 | 345 | 351 | 3.95 | 3 | B25620B0298K883 |

¹ Please refer to current derating section for more details

² ESR at 1 kHz (typical value)

³ H_c is typical value

⁴ Weight is typical value

Other configurations and capacitance tolerances available upon request

$V_{RDC} = 1100 \text{ V DC} / V_{TT} = 1650 \text{ V DC}, 10\text{s} / V_{TC} = 4000 \text{ V AC}, 10\text{s}$

| C_R μF | I_{MAX}^1 A | I_s kA | \hat{I} kA | ESR ² m Ω | L_{self} nH | R_{TH} K/W | D mm | H_c^3 mm | H_r mm | Weight ⁴ kg | Fig. | Ordering code |
|------------------------|------------------|-------------|-----------------|--------------------------------|------------------|-----------------|---------|---------------|-------------|---------------------------|------|-----------------------------------|
| 140 | 50 | 7.7 | 2.6 | 1.8 | ≤ 40 | 4 | 85 | 70 | 76 | 0.45 | 1 | B25620B1147K101 |
| 140 | 50 | 7.7 | 2.6 | 1.8 | ≤ 40 | 4 | 85 | 74 | 76 | 0.48 | 2 | B25620C1147K101 |
| 230 | 50 | 7.2 | 2.3 | 1.9 | ≤ 40 | 3.3 | 85 | 95 | 101 | 0.58 | 1 | B25620B1237K101 |
| 280 | 75 | 15.5 | 5.1 | 1.2 | ≤ 40 | 2.9 | 116 | 70 | 76 | 0.88 | 3 | B25620B1287K103 |
| 310 | 50 | 7.7 | 2.6 | 2.3 | ≤ 40 | 2.9 | 85 | 120 | 126 | 0.71 | 1 | B25620B1317K101 |
| 310 | 50 | 7.7 | 2.6 | 2.3 | ≤ 40 | 2.9 | 85 | 124 | 126 | 0.74 | 2 | B25620C1317K101 |
| 420 | 63 | 8.8 | 2.9 | 2.4 | ≤ 40 | 2.8 | 85 | 135 | 141 | 0.87 | 1 | B25620B1427A101 * |
| 420 | 63 | 8.8 | 2.9 | 2.4 | ≤ 40 | 2.8 | 85 | 139 | 141 | 0.89 | 2 | B25620C1427A101 * |
| 420 | 75 | 17.3 | 5.8 | 1.7 | ≤ 40 | 2.4 | 85 | 155 | 161 | 1 | 1 | B25620B1427K101 |
| 420 | 75 | 17.3 | 5.8 | 1.7 | ≤ 40 | 2.4 | 85 | 159 | 161 | 1.03 | 2 | B25620C1427K101 |
| 450 | 75 | 14.9 | 4.9 | 1.3 | ≤ 40 | 2.3 | 116 | 95 | 101 | 1.13 | 3 | B25620B1457K103 |
| 480 | 80 | 15.6 | 5.2 | 1.8 | ≤ 60 | 2.1 | 85 | 173 | 179 | 1.1 | 1 | B25620B1487K101 |
| 480 | 80 | 15.6 | 5.2 | 1.8 | ≤ 60 | 2.1 | 85 | 177 | 179 | 1.13 | 2 | B25620C1487K101 |
| 610 | 80 | 15.1 | 5 | 1.7 | ≤ 40 | 2.2 | 116 | 120 | 126 | 1.4 | 3 | B25620B1617K103 |
| 650 | 80 | 13.4 | 4.4 | 1.8 | ≤ 90 | 1.9 | 85 | 248 | 254 | 1.51 | 1 | B25620B1657K101 |
| 700 | 80 | 15.1 | 5 | 1.7 | ≤ 40 | 2.1 | 116 | 132 | 138 | 1.55 | 3 | B25620B1707K103 |
| 940 | 100 | 29.4 | 9.9 | 1.2 | ≤ 60 | 2 | 116 | 173 | 179 | 2.05 | 3 | B25620B1947K103 |
| 1100 | 100 | 27.7 | 9.3 | 1.3 | ≤ 100 | 1.8 | 116 | 223 | 229 | 2.56 | 3 | B25620B1118K103 |
| 1400 | 100 | 28.9 | 9.6 | 1.3 | ≤ 90 | 1.8 | 116 | 248 | 254 | 2.85 | 3 | B25620B1148K103 |
| 1500 | 100 | 29.3 | 9.7 | 1.5 | ≤ 90 | 1.7 | 116 | 273 | 279 | 3.13 | 3 | B25620B1158K103 |
| 1900 | 100 | 34.4 | 11.5 | 1.2 | ≤ 100 | 1.4 | 116 | 345 | 351 | 3.95 | 3 | B25620B1198K103 |

* Capacitance tolerance A: -15% ... 0%

¹ Please refer to current derating section for more details

² ESR at 1 kHz (typical value)

³ H_c is typical value

⁴ Weight is typical value

Other configurations and capacitance tolerances available upon request

$V_{RDC} = 1200 \text{ V DC} / V_{TT} = 1800 \text{ V DC}, 10\text{s} / V_{TC} = 4000 \text{ V AC}, 10\text{s}$

| C_R μF | I_{MAX}^1 A | I_s kA | \hat{I} kA | ESR ² m Ω | L_{self} nH | R_{TH} K/W | D mm | H_c^3 mm | H_r mm | Weight ⁴ kg | Fig. | Ordering code |
|------------------------|------------------|-------------|-----------------|--------------------------------|------------------|-----------------|---------|---------------|-------------|---------------------------|------|---------------------------------|
| 120 | 50 | 7.1 | 2.4 | 1.9 | ≤ 40 | 4 | 85 | 70 | 76 | 0.45 | 1 | B25620B1127K201 |
| 180 | 50 | 7.1 | 2.4 | 2.1 | ≤ 40 | 3.3 | 85 | 95 | 101 | 0.58 | 1 | B25620B1187K201 |
| 250 | 50 | 7.1 | 2.4 | 2.4 | ≤ 40 | 2.9 | 85 | 120 | 126 | 0.71 | 1 | B25620B1257K201 |
| 280 | 50 | 7.1 | 2.4 | 2.5 | ≤ 40 | 2.8 | 85 | 132 | 138 | 0.84 | 1 | B25620B1287K201 |
| 300 | 65 | 14.0 | 4.7 | 1.8 | ≤ 40 | 2.4 | 85 | 155 | 161 | 1 | 1 | B25620B1307K201 |
| 350 | 65 | 13.6 | 4.5 | 1.9 | ≤ 60 | 2.1 | 85 | 173 | 179 | 1.1 | 1 | B25620B1357K201 |
| 360 | 70 | 15.2 | 5.1 | 1.6 | ≤ 40 | 2.3 | 116 | 95 | 101 | 1.13 | 3 | B25620B1367K203 |
| 500 | 75 | 15.3 | 5.1 | 1.7 | ≤ 40 | 2.2 | 116 | 120 | 126 | 1.4 | 3 | B25620B1507K203 |
| 520 | 70 | 14.9 | 4.9 | 1.6 | ≤ 60 | 1.9 | 85 | 223 | 229 | 1.4 | 1 | B25620B1527K201 |
| 570 | 75 | 15.4 | 5.1 | 1.7 | ≤ 40 | 2.1 | 116 | 132 | 138 | 1.55 | 3 | B25620B1577K203 |
| 600 | 70 | 15.1 | 5.0 | 1.7 | ≤ 90 | 1.9 | 85 | 248 | 254 | 1.51 | 1 | B25620B1607K201 |
| 620 | 80 | 29.3 | 9.7 | 1.3 | ≤ 60 | 2.1 | 116 | 155 | 161 | 1.85 | 3 | B25620B1627K203 |
| 730 | 100 | 30.8 | 10.2 | 1.3 | ≤ 60 | 2 | 116 | 173 | 179 | 2.05 | 3 | B25620B1737K203 |
| 1000 | 100 | 30.7 | 10.2 | 1.4 | ≤ 90 | 1.8 | 116 | 223 | 229 | 2.56 | 3 | B25620B1108K203 |
| 1200 | 100 | 29.7 | 9.9 | 1.4 | ≤ 90 | 1.8 | 116 | 248 | 254 | 2.85 | 3 | B25620B1128K203 |
| 1500 | 100 | 36.7 | 12.3 | 1.3 | ≤ 100 | 1.4 | 116 | 345 | 351 | 3.95 | 3 | B25620B1158K203 |

¹ Please refer to current derating section for more details

² ESR at 1 kHz (typical value)

³ H_c is typical value

⁴ Weight is typical value

Other configurations and capacitance tolerances available upon request

$V_{RDC} = 1320 \text{ V DC} / V_{TT} = 1980 \text{ V DC}, 10\text{s} / V_{TC} = 4000 \text{ V AC}, 10\text{s}$

| C_R μF | I_{MAX}^1 A | I_s kA | \hat{I} kA | ESR ² m Ω | L_{self} nH | R_{TH} K/W | D mm | H_c^3 mm | H_T mm | Weight ⁴ kg | Fig. | Ordering code |
|------------------------|------------------|-------------|-----------------|--------------------------------|------------------|-----------------|---------|---------------|-------------|---------------------------|------|---------------------------------|
| 100 | 45 | 6.6 | 2.2 | 2.2 | ≤ 40 | 4 | 85 | 70 | 76 | 0.45 | 1 | B25620B1107K321 |
| 160 | 48 | 6.8 | 2.3 | 2.3 | ≤ 40 | 3.3 | 85 | 95 | 101 | 0.58 | 1 | B25620B1167K321 |
| 220 | 45 | 7.4 | 2.5 | 2.6 | ≤ 40 | 2.9 | 85 | 120 | 126 | 0.71 | 1 | B25620B1227K321 |
| 220 | 45 | 7.4 | 2.5 | 2.6 | ≤ 40 | 2.9 | 85 | 124 | 126 | 0.74 | 2 | B25620C1227K321 |
| 260 | 45 | 7.6 | 2.6 | 2.7 | ≤ 40 | 2.8 | 85 | 132 | 138 | 0.84 | 1 | B25620B1267K321 |
| 260 | 45 | 7.6 | 2.6 | 2.7 | ≤ 40 | 2.8 | 85 | 136 | 138 | 0.87 | 2 | B25620C1267K321 |
| 310 | 65 | 14.3 | 4.8 | 1.7 | ≤ 40 | 2.3 | 116 | 95 | 101 | 1.13 | 3 | B25620B1317K323 |
| 340 | 70 | 14.8 | 5.0 | 2.1 | ≤ 60 | 2.1 | 85 | 173 | 179 | 1.1 | 1 | B25620B1347K321 |
| 340 | 70 | 14.8 | 5.0 | 2.1 | ≤ 60 | 2.1 | 85 | 177 | 179 | 1.13 | 2 | B25620C1347K321 |
| 400 | 70 | 12.4 | 4.1 | 2.2 | ≤ 90 | 1.9 | 85 | 223 | 229 | 1.4 | 1 | B25620B1407K321 |
| 420 | 65 | 14.1 | 4.7 | 1.8 | ≤ 40 | 2.2 | 116 | 120 | 126 | 1.4 | 3 | B25620B1427K323 |
| 480 | 70 | 14.1 | 4.7 | 1.8 | ≤ 40 | 2.1 | 116 | 132 | 138 | 1.55 | 3 | B25620B1487K323 |
| 500 | 70 | 13.8 | 4.6 | 2.3 | ≤ 90 | 1.9 | 85 | 248 | 254 | 1.51 | 1 | B25620B1507K321 |
| 520 | 80 | 26.9 | 8.9 | 1.4 | ≤ 60 | 2.1 | 116 | 155 | 161 | 1.85 | 3 | B25620B1527K323 |
| 660 | 100 | 27.8 | 9.3 | 1.4 | ≤ 90 | 2 | 116 | 173 | 179 | 2.05 | 3 | B25620B1667K323 |
| 880 | 100 | 27.4 | 9.1 | 1.6 | ≤ 90 | 1.8 | 116 | 223 | 229 | 2.56 | 3 | B25620B1887K323 |
| 940 | 100 | 26.9 | 8.9 | 1.6 | ≤ 90 | 1.8 | 116 | 248 | 254 | 2.85 | 3 | B25620B1947K323 |
| 1000 | 100 | 26.4 | 8.8 | 1.6 | ≤ 90 | 1.7 | 116 | 273 | 279 | 3.13 | 3 | B25620B1108K323 |
| 1300 | 100 | 36.3 | 12.1 | 1.4 | ≤ 100 | 1.4 | 116 | 345 | 351 | 3.95 | 3 | B25620B1138K323 |

¹ Please refer to current derating section for more details

² ESR at 1 kHz (typical value)

³ H_c is typical value

⁴ Weight is typical value

Other configurations and capacitance tolerances available upon request

$V_{RDC} = 1500 \text{ V DC} / V_{TT} = 2250 \text{ V DC}, 10\text{s} / V_{TC} = 4000 \text{ V AC}, 10\text{s}$

| C_R μF | I_{MAX}^1 A | I_s kA | \hat{I} kA | ESR ² m Ω | L_{self} nH | R_{TH} K/W | D mm | H_c^3 mm | H_T mm | Weight ⁴ kg | Fig. | Ordering Code |
|------------------------|------------------|-------------|-----------------|--------------------------------|------------------|-----------------|---------|---------------|-------------|---------------------------|------|----------------------------------|
| 85 | 40 | 6.4 | 2.1 | 2.4 | ≤ 40 | 4 | 85 | 70 | 76 | 0.45 | 1 | B25620B1856K501* |
| 140 | 40 | 6.4 | 2.1 | 2.6 | ≤ 40 | 3.3 | 85 | 95 | 101 | 0.58 | 1 | B25620B1147K501* |
| 190 | 40 | 6.4 | 2.1 | 2.8 | ≤ 40 | 2.9 | 85 | 120 | 126 | 0.71 | 1 | B25620B1197K501* |
| 220 | 40 | 6.6 | 2.2 | 2.7 | ≤ 40 | 2.8 | 85 | 132 | 138 | 0.84 | 1 | B25620B1227K501* |
| 215 | 50 | 12.9 | 4.3 | 2.3 | ≤ 40 | 2.4 | 85 | 155 | 161 | 1 | 1 | B25620B1217K501* |
| 270 | 50 | 12.4 | 4.1 | 1.8 | ≤ 40 | 2.3 | 116 | 95 | 101 | 1.13 | 3 | B25620B1277K503* |
| 280 | 50 | 12.9 | 4.3 | 2.3 | ≤ 60 | 2.1 | 85 | 173 | 179 | 1.1 | 1 | B25620B1287K501* |
| 370 | 50 | 12.5 | 4.2 | 2.3 | ≤ 40 | 2.2 | 116 | 120 | 126 | 1.4 | 3 | B25620B1377K503* |
| 380 | 70 | 12.8 | 4.3 | 2.5 | ≤ 90 | 1.9 | 85 | 223 | 229 | 1.4 | 1 | B25620B1387K501 |
| 420 | 50 | 12.5 | 4.2 | 2.3 | ≤ 40 | 2.1 | 116 | 132 | 139 | 1.55 | 3 | B25620B1427K503* |
| 440 | 70 | 13.1 | 4.4 | 2.6 | ≤ 90 | 1.9 | 85 | 248 | 254 | 1.51 | 1 | B25620B1447K501 |
| 440 | 60 | 25.2 | 8.4 | 1.7 | ≤ 60 | 2.1 | 116 | 155 | 161 | 1.85 | 3 | B25620B1447K503 |
| 550 | 60 | 25.2 | 8.4 | 1.6 | ≤ 90 | 2 | 116 | 173 | 179 | 2.05 | 3 | B25620B1557K503 |
| 740 | 80 | 25.0 | 8.3 | 1.8 | ≤ 90 | 1.8 | 116 | 223 | 229 | 2.56 | 3 | B25620B1747K503 |
| 840 | 80 | 25.1 | 8.4 | 1.8 | ≤ 90 | 1.8 | 116 | 248 | 254 | 2.85 | 3 | B25620B1847K503 |
| 1100 | 100 | 33.3 | 11.1 | 1.5 | ≤ 100 | 1.4 | 116 | 345 | 351 | 3.95 | 3 | B25620B1118K503 |

¹ Please refer to current derating section for more details

² ESR at 1 kHz (typical value)

³ H_c is typical value

⁴ Weight is typical value

Other configurations and capacitance tolerances available upon request

*** This ordering code is affected by "Dual Use" regulations according to Export Control law. Deliveries of such products are subject to prior approval by Export Control authorities based on customer declarations. The delivery to certain countries might be restricted.**

V_{RDC} = 2000 V DC / V_{TT} = 3000 V DC, 10s / V_{TC} = 4000 V AC, 10s

| C _R μF | I _{MAX} ¹ A | I _s kA | Ĥ kA | ESR ² mΩ | L _{self} nH | R _{TH} K/W | D mm | H _c ³ mm | H _r mm | Weight ⁴ kg | Fig. | Ordering Code |
|----------------------|------------------------------------|----------------------|---------|------------------------|-------------------------|------------------------|---------|-----------------------------------|----------------------|---------------------------|------|----------------------------------|
| 40 | 35 | 4.5 | 1.5 | 3.3 | ≤ 60 | 4 | 85 | 70 | 76 | 0.45 | 1 | B25620B1406K981* |
| 40 | 35 | 4.5 | 1.5 | 3.3 | ≤ 60 | 4 | 85 | 74 | 76 | 0.48 | 2 | B25620C1406K981* |
| 70 | 40 | 4.9 | 1.6 | 3.5 | ≤ 60 | 3.3 | 85 | 95 | 101 | 0.58 | 1 | B25620B1706K981* |
| 70 | 40 | 4.9 | 1.6 | 3.5 | ≤ 60 | 3.3 | 85 | 99 | 101 | 0.61 | 2 | B25620C1706K981* |
| 100 | 40 | 4.9 | 1.6 | 3.6 | ≤ 60 | 2.9 | 85 | 120 | 126 | 0.71 | 1 | B25620B1107K981* |
| 145 | 50 | 10.0 | 3.4 | 2.7 | ≤ 60 | 2.1 | 85 | 173 | 179 | 1.1 | 1 | B25620B1147K981* |
| 145 | 50 | 10.0 | 3.4 | 2.7 | ≤ 60 | 2.1 | 85 | 177 | 179 | 1.13 | 2 | B25620C1147K981* |
| 190 | 60 | 9.6 | 3.2 | 2.8 | ≤ 60 | 2.2 | 116 | 120 | 126 | 1.4 | 3 | B25620B1197K983* |
| 200 | 70 | 9.3 | 3.1 | 2.8 | ≤ 90 | 1.9 | 85 | 223 | 229 | 1.4 | 1 | B25620B1207K981 |
| 215 | 60 | 9.6 | 3.2 | 2.9 | ≤ 40 | 2.1 | 116 | 132 | 138 | 1.55 | 3 | B25620B1217K983* |
| 220 | 70 | 9.0 | 3.0 | 2.8 | ≤ 90 | 1.9 | 85 | 248 | 254 | 1.51 | 1 | B25620B1227K981 |
| 230 | 80 | 17.8 | 5.9 | 1.8 | ≤ 40 | 2.1 | 116 | 155 | 161 | 1.85 | 3 | B25620B1237K983* |
| 295 | 80 | 18.8 | 6.3 | 1.9 | ≤ 60 | 2 | 116 | 173 | 179 | 2.05 | 3 | B25620B1297K983 |
| 380 | 80 | 17.8 | 5.9 | 2.2 | ≤ 90 | 1.8 | 116 | 223 | 229 | 2.56 | 3 | B25620B1387K983 |
| 440 | 80 | 18.2 | 6.1 | 2.5 | ≤ 90 | 1.8 | 116 | 248 | 254 | 2.85 | 3 | B25620B1447K983 |
| 460 | 100 | 18.2 | 6.0 | 2.8 | ≤ 90 | 1.7 | 116 | 263 | 269 | 3 | 3 | B25620B1467K983 |
| 510 | 100 | 19.3 | 6.4 | 3 | ≤ 90 | 1.7 | 116 | 273 | 279 | 3.13 | 3 | B25620B1517K983 |
| 600 | 100 | 25.1 | 8.4 | 2.2 | ≤ 100 | 1.4 | 116 | 345 | 351 | 3.95 | 3 | B25620B1607K983 |

¹ Please refer to current derating section for more details

² ESR at 1 kHz (typical value)

³ H_c is typical value

⁴ Weight is typical value

Other configurations and capacitance tolerances available upon request

*** This ordering code is affected by "Dual Use" regulations according to Export Control law. Deliveries of such products are subject to prior approval by Export Control authorities based on customer declarations. The delivery to certain countries might be restricted.**

Display of ordering codes for TDK Electronics products

The ordering code for one and the same product can be represented differently in data sheets, data books, other publications, on the company website, or in order-related documents such as shipping notes, order confirmations and product labels. **The varying representations of the ordering codes are due to different processes employed and do not affect the specifications of the respective products.** Detailed information can be found on the Internet under www.tdk-electronics.tdk.com/orderingcodes.

2. Current derating

2.1 Current derating graphs for capacitors 700 V_{RDC}

B25620B0287K701

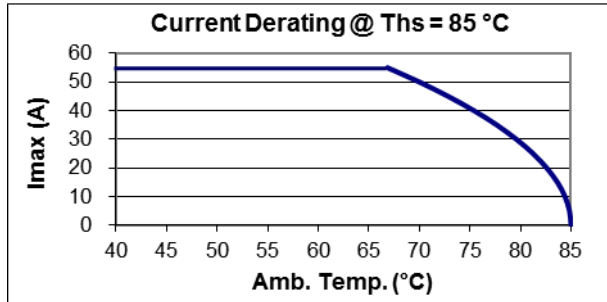

B25620B0477K701

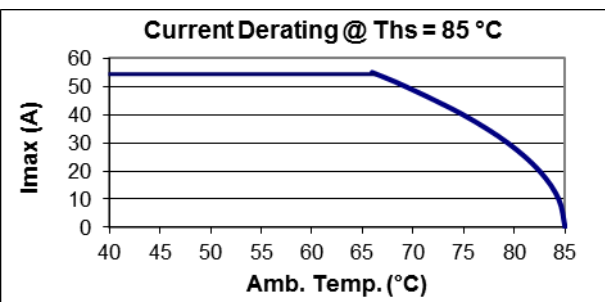

B25620B0567K703

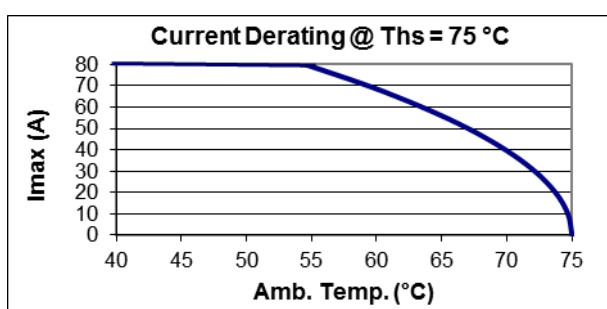

B25620B0627K701

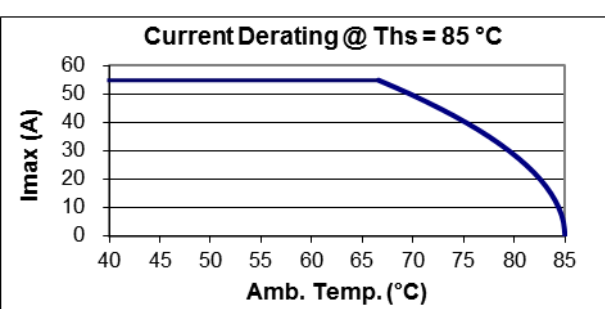

B25620B0707K701/ B25620C0707K701

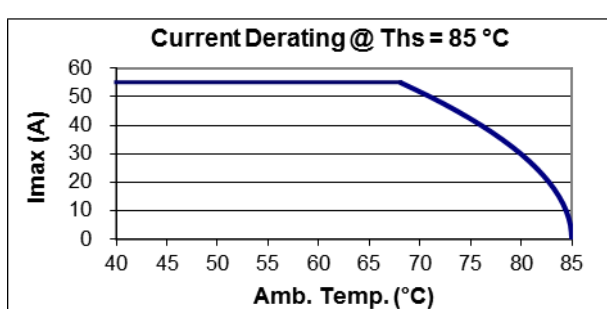

B25620B0757K701

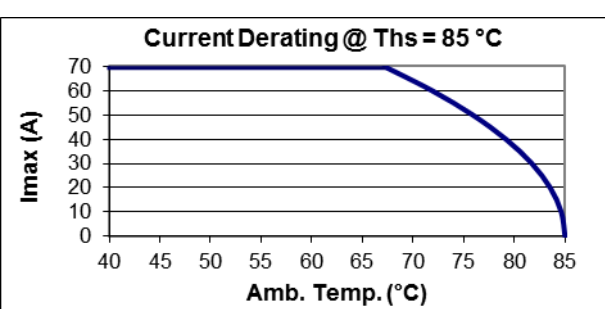

B25620B0907K703

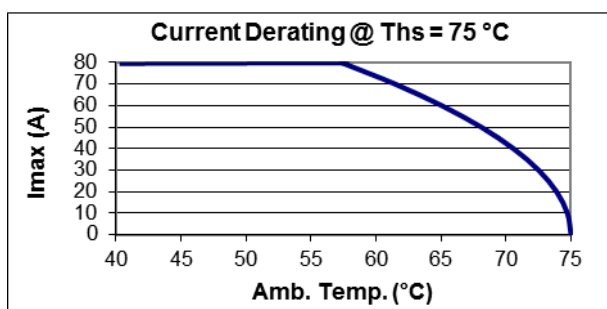

B25620B0957K701

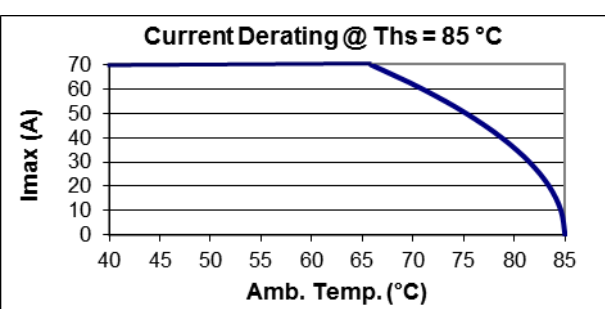

B25620B0128K743

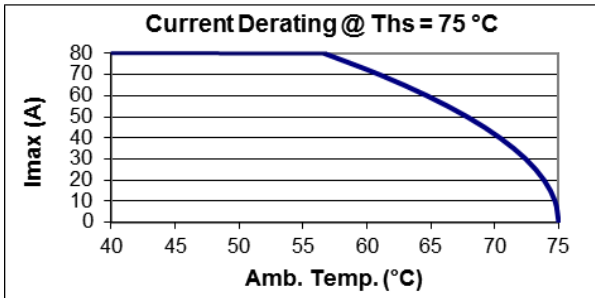

B25620B0138K701

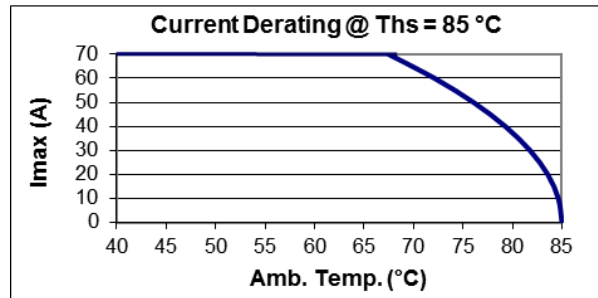

B25620B0148K703

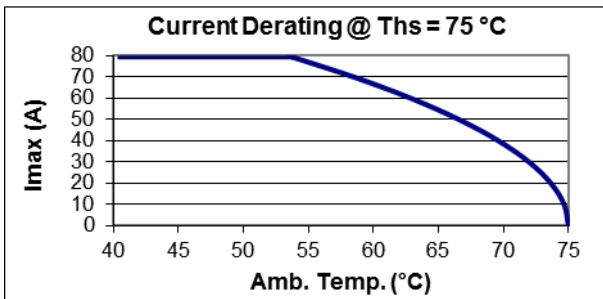

B25620B0158K703

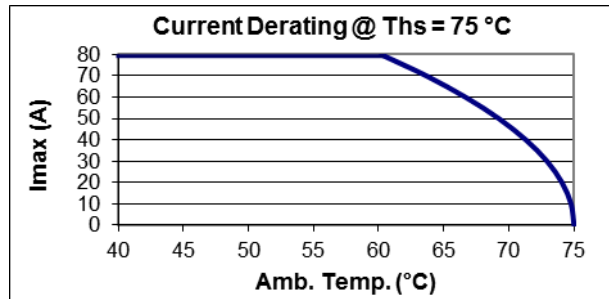

B25620B0198K703

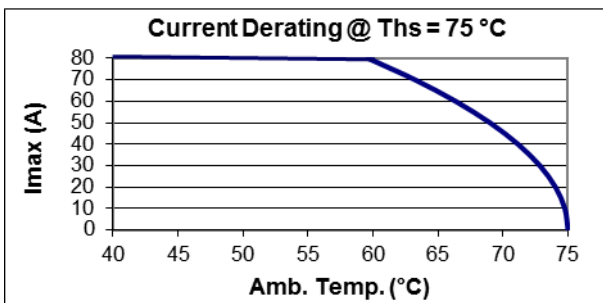

B25620B0268K703

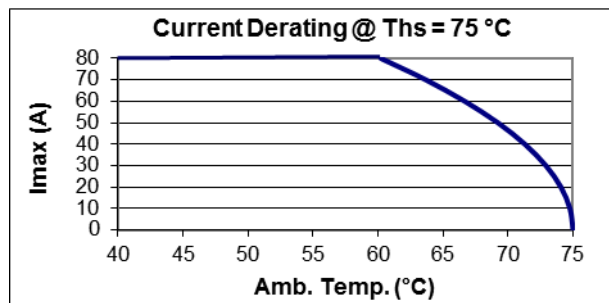

B25620B0298K703

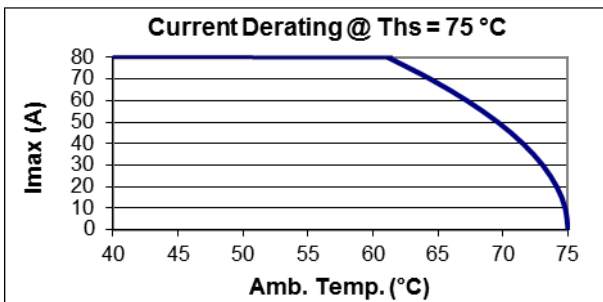

B25620B0408K703/ B25620C0408K703

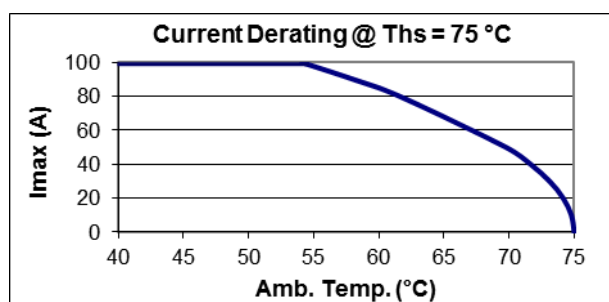

2.2 Current derating graphs for capacitors 900 V_{RDC}

B25620B0227K881/ B25620C0227K881

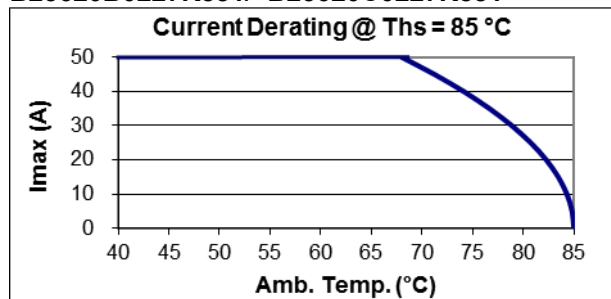

B25620B0357K881/ B25620C0357K881

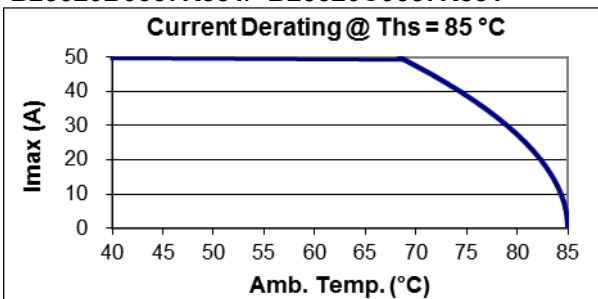

B25620B0447K883

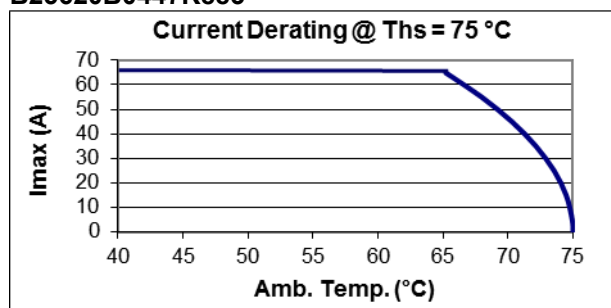

B25620B0487K881/ B25620C0487K881

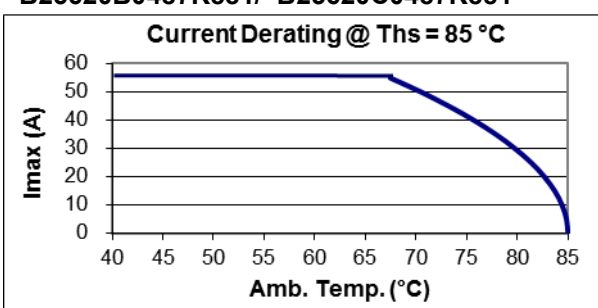

B25620B0557K881/ B25620C0557K881

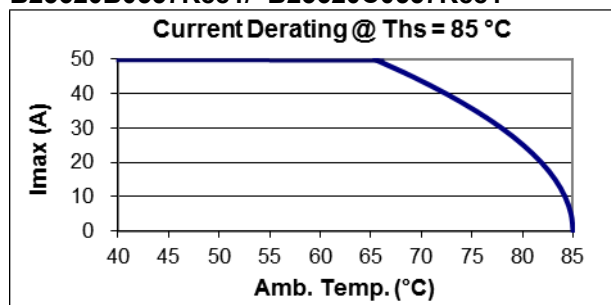

B25620B0607K881

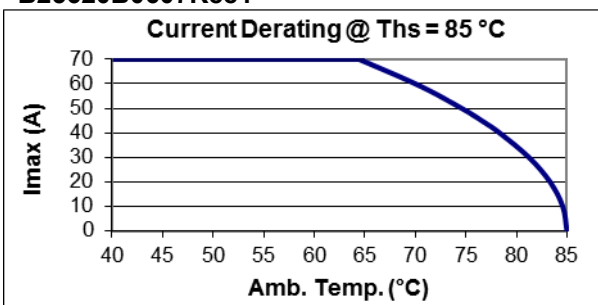

B25620B0707K883

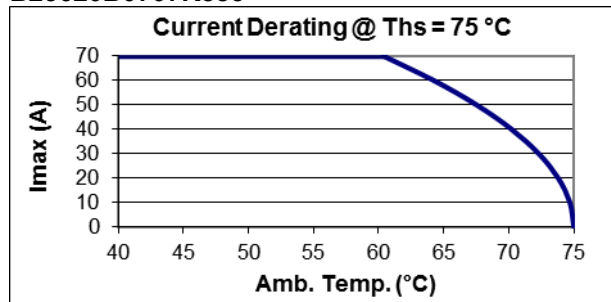

B25620B0757K881/ B25620C0757K881

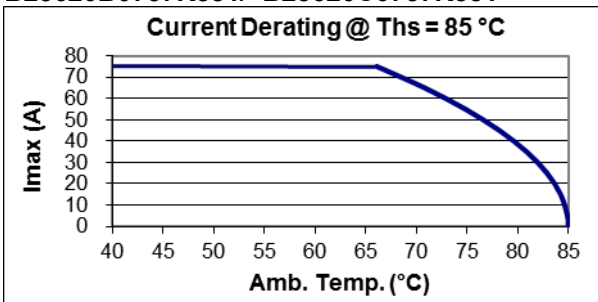

B25620B0907K881

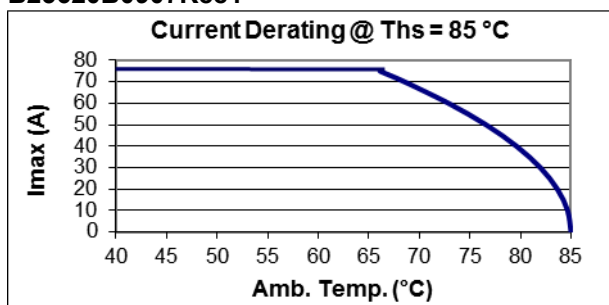

B25620B0977K883

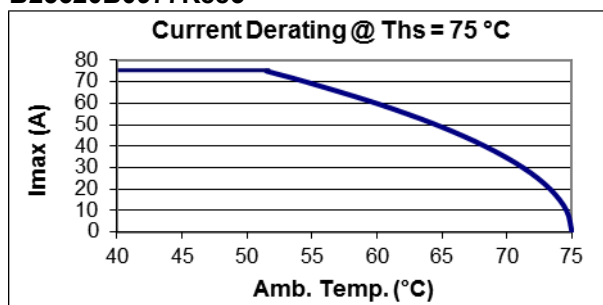

B25620B0108K881

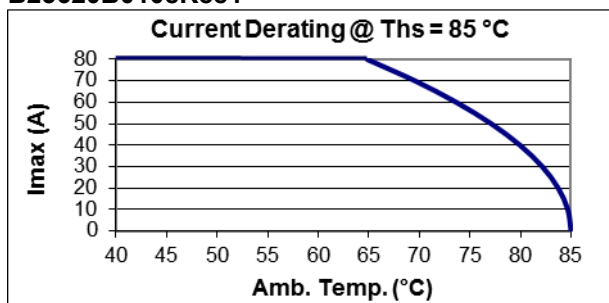

B25620B0118K883

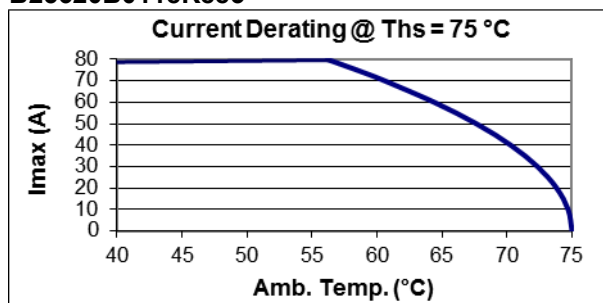

B25620B0128K883

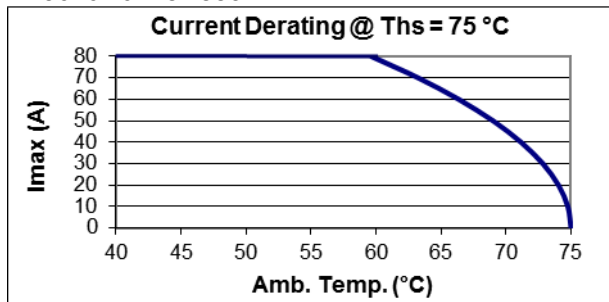

B25620B0158K883/ B25620C0158K883

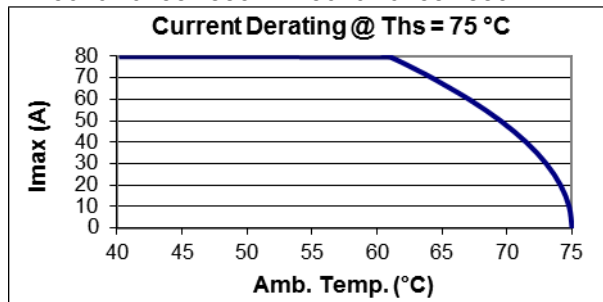

B25620B0208K883

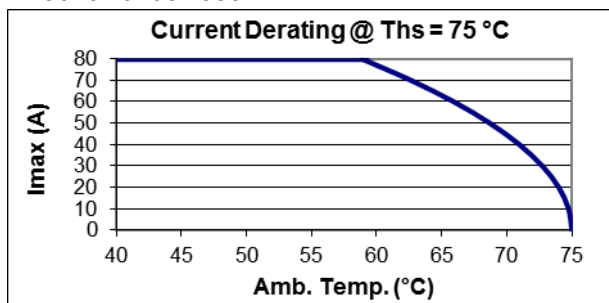

B25620B0228K883

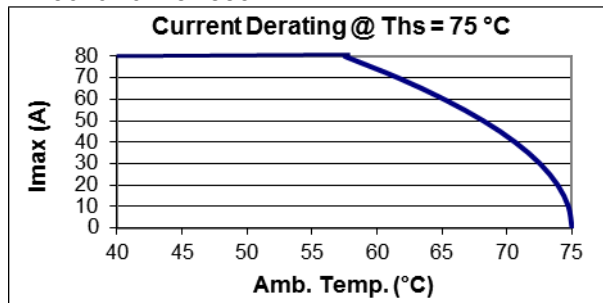

B25620B0298K883

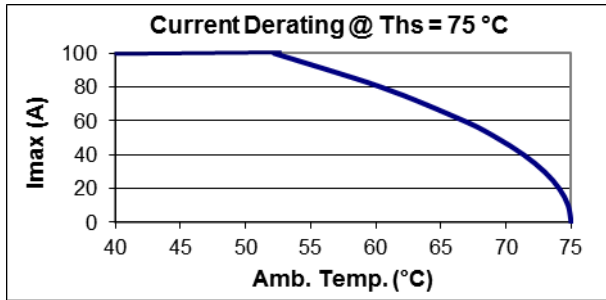

2.3 Current derating graphs for capacitors 1100 V_{RDC}

B25620B1147K101/ B25620C1147K101

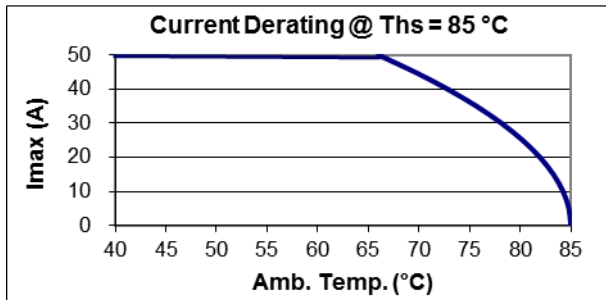

B25620B1237K101

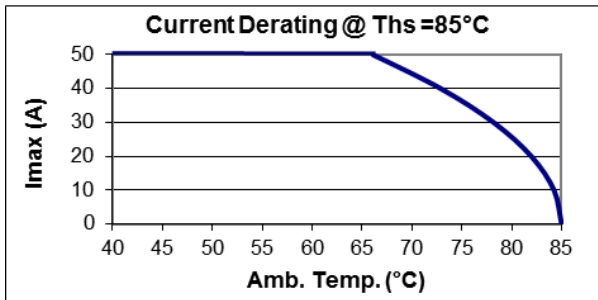

B25620B1287K103

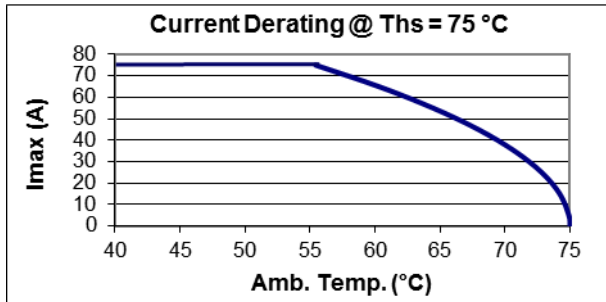

B25620B1317K101/ B25620C1317K101

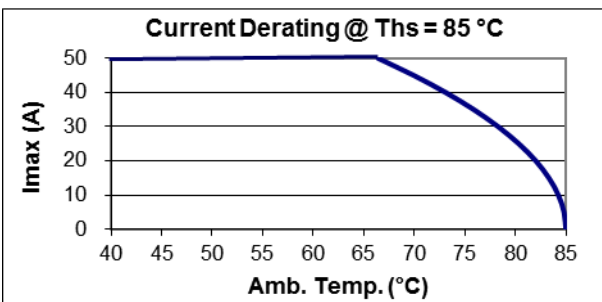

B25620B1427A101/ B25620C1427A101

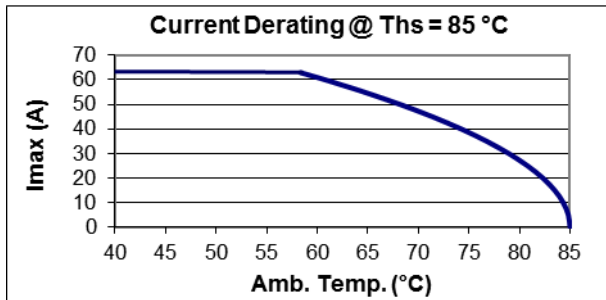

B25620B1427K101/ B25620C1427K101

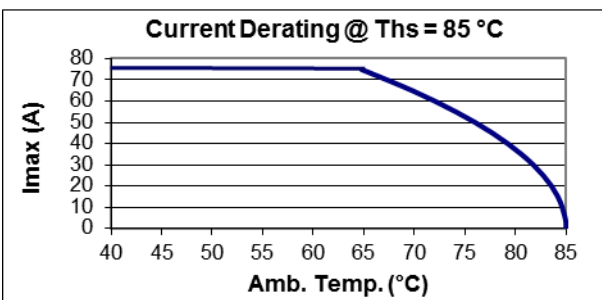

B25620B1457K103

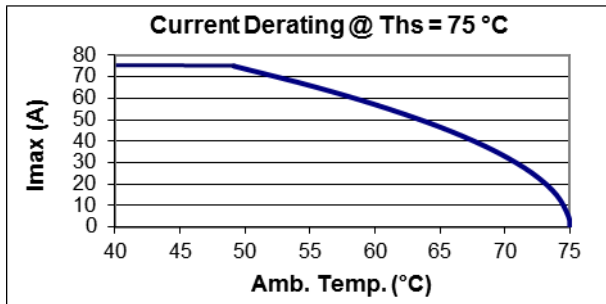

B25620B1487K101/ B25620C1487K101

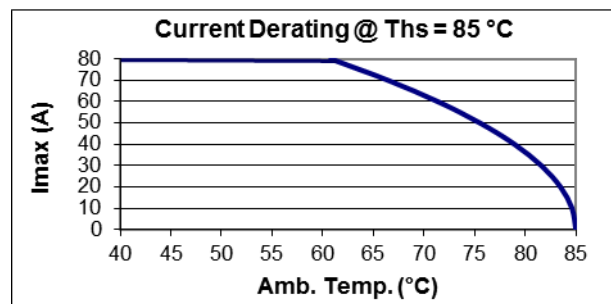

B25620B1617K103

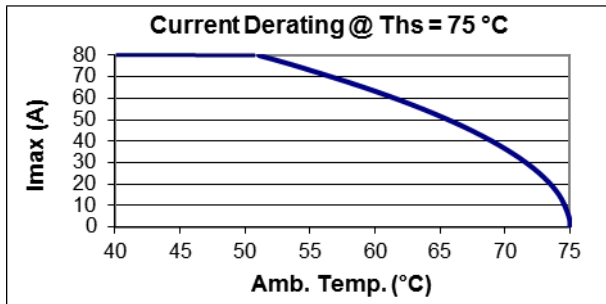

B25620B1657K101

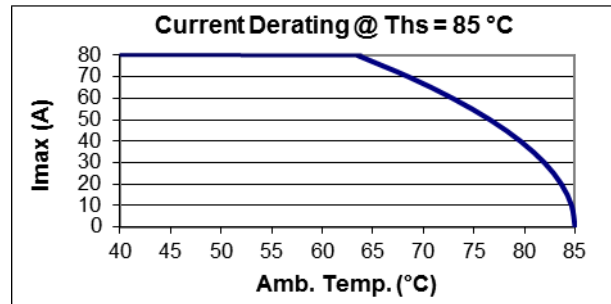

B25620B1707K103

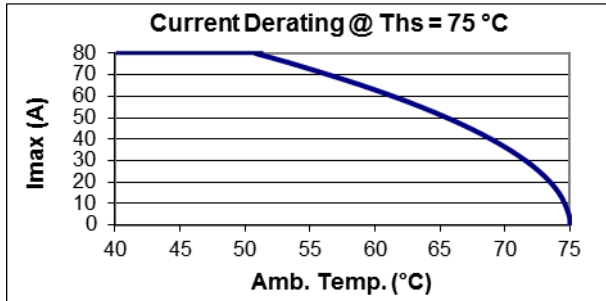

B25620B1947K103

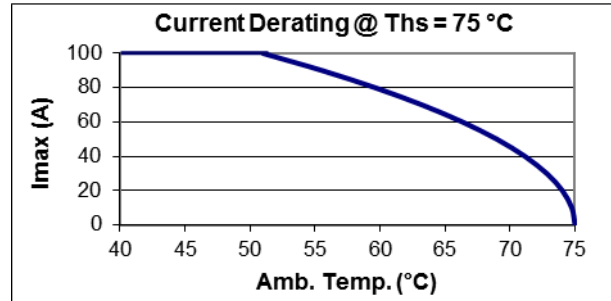

B25620B1118K103

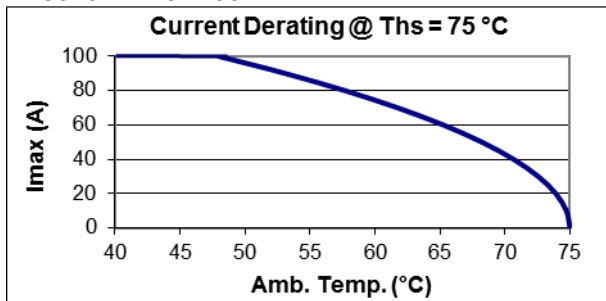

B25620B1148K103

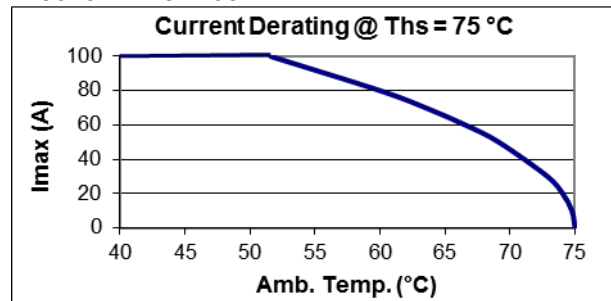

B25620B1158K103

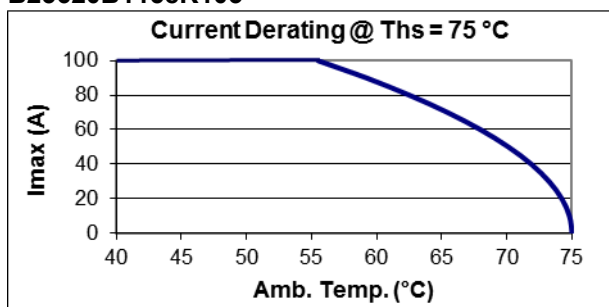

B25620B1198K103

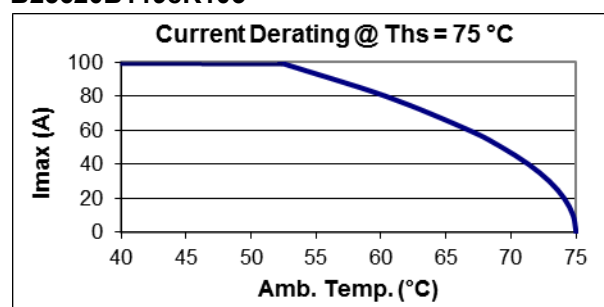

2.4 Current derating graphs for capacitors 1200 V_{RDC}

B25620B1127K201

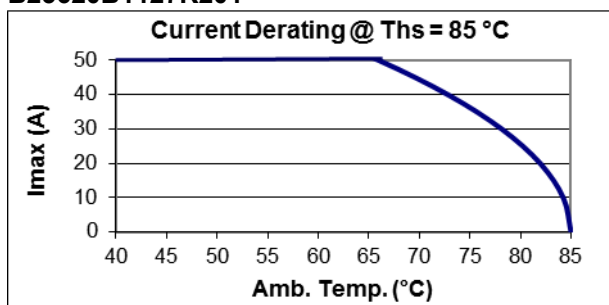

B25620B1187K201

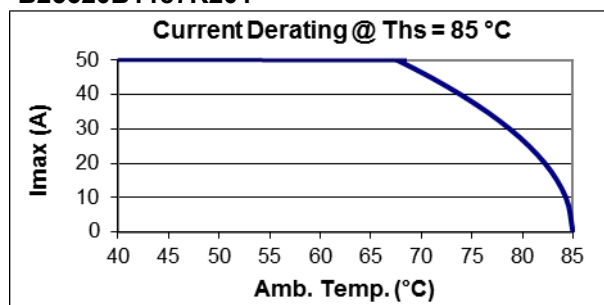

B25620B1257K201

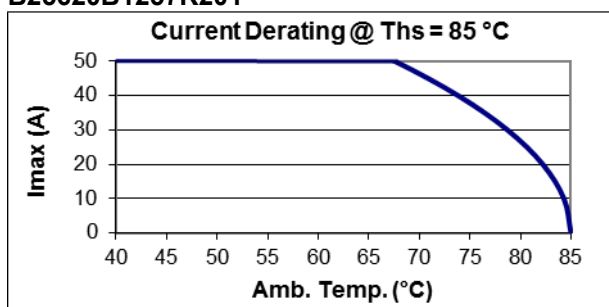

B25620B1287K201

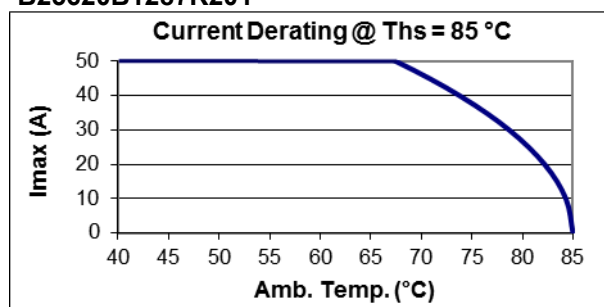

B25620B1307K201

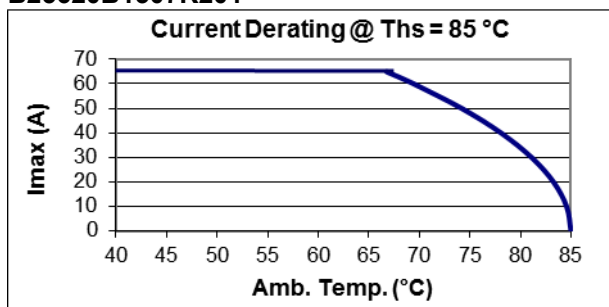

B25620B1357K201

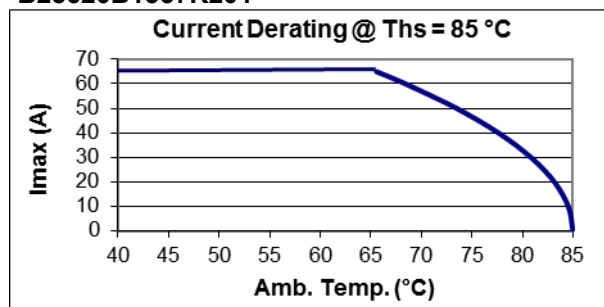

B25620B1367K203

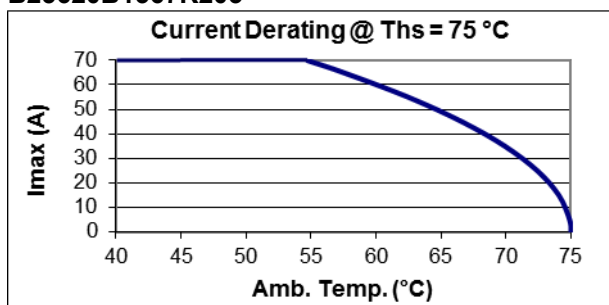

B25620B1507K203

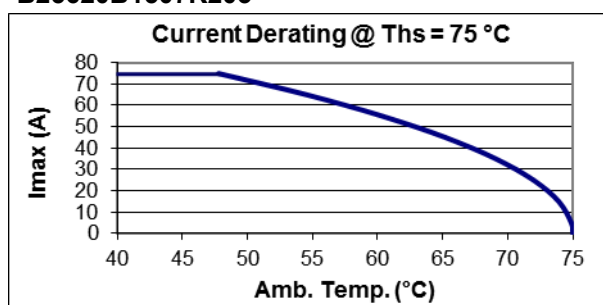

B25620B1527K201

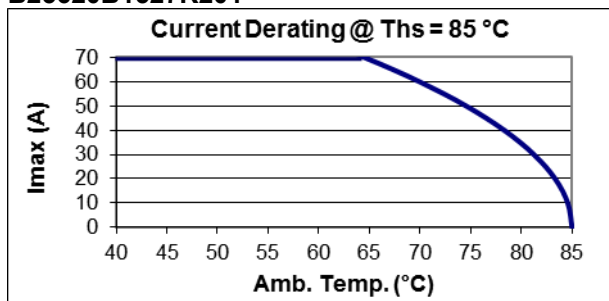

B25620B1577K203

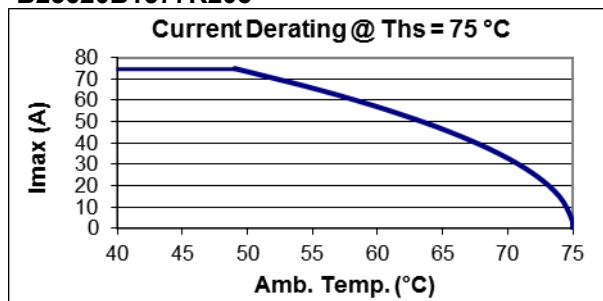

B25620B1607K201

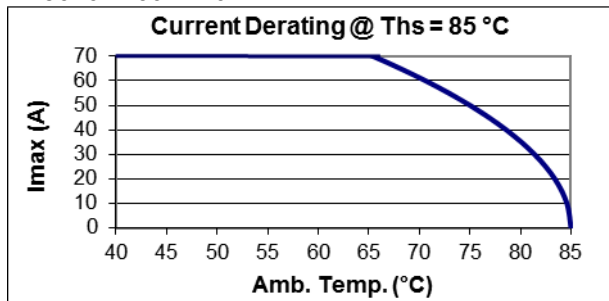

B25620B1627K203

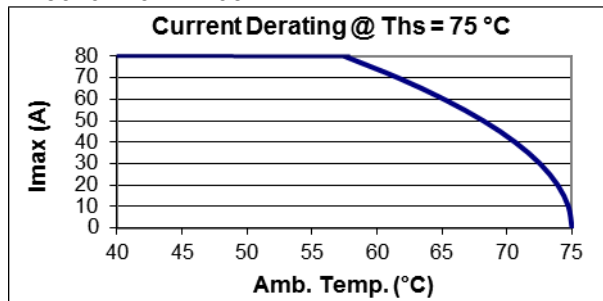

B25620B1737K203

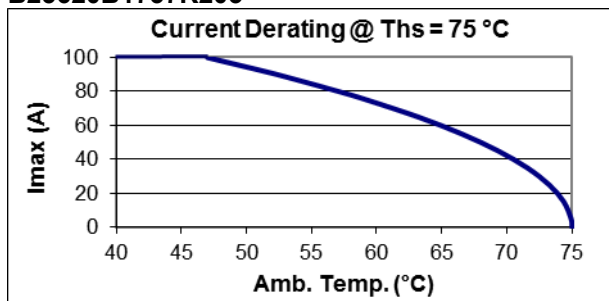

B25620B1108K203

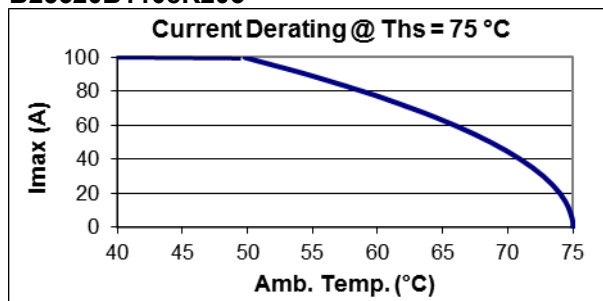

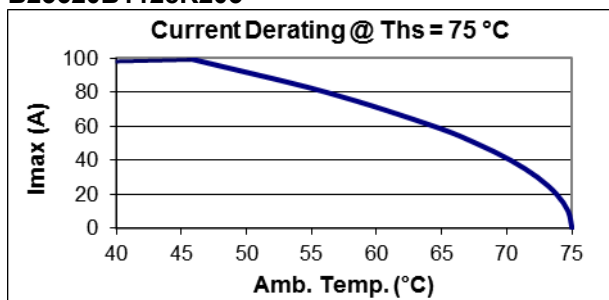
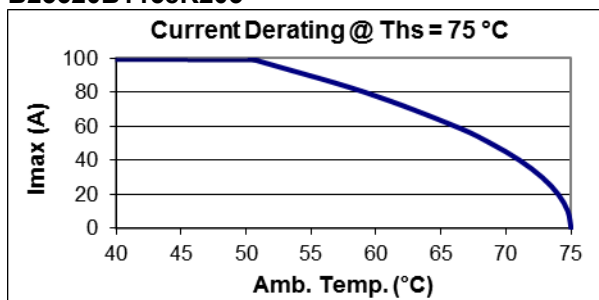
B25620B1128K203

B25620B1158K203

Current derating graphs are based on typical values. Graphs for capacitors rated 1320 / 1500 / 2000 V_{RDC} are available upon request.

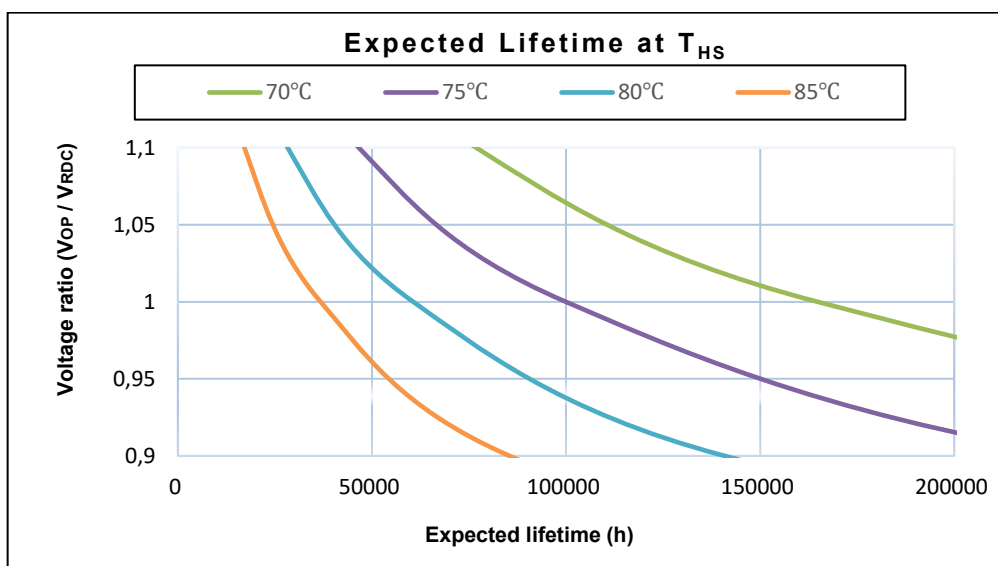
3. Service life



Service life t_{LD} in hours at different hotspot temperature (T_{hs}) and voltage V_{RDC}

For capacitors with diameter 116mm a maximum hot spot temperature of 85°C is allowed during short term operation (maximum 10% of the total load duration) without further reduction of the service life.

Failure criteria is capacitance drop higher than 3%.

Lifetime estimations are typical theoretical values derived from lifetime tests based on TDK internal standards or mutually agreed test methods and are intended for guidance purposes only. The useful life does not constitute a warranty of any kind or a prolongation of the agreed warranty period.

4. Expected failure rate

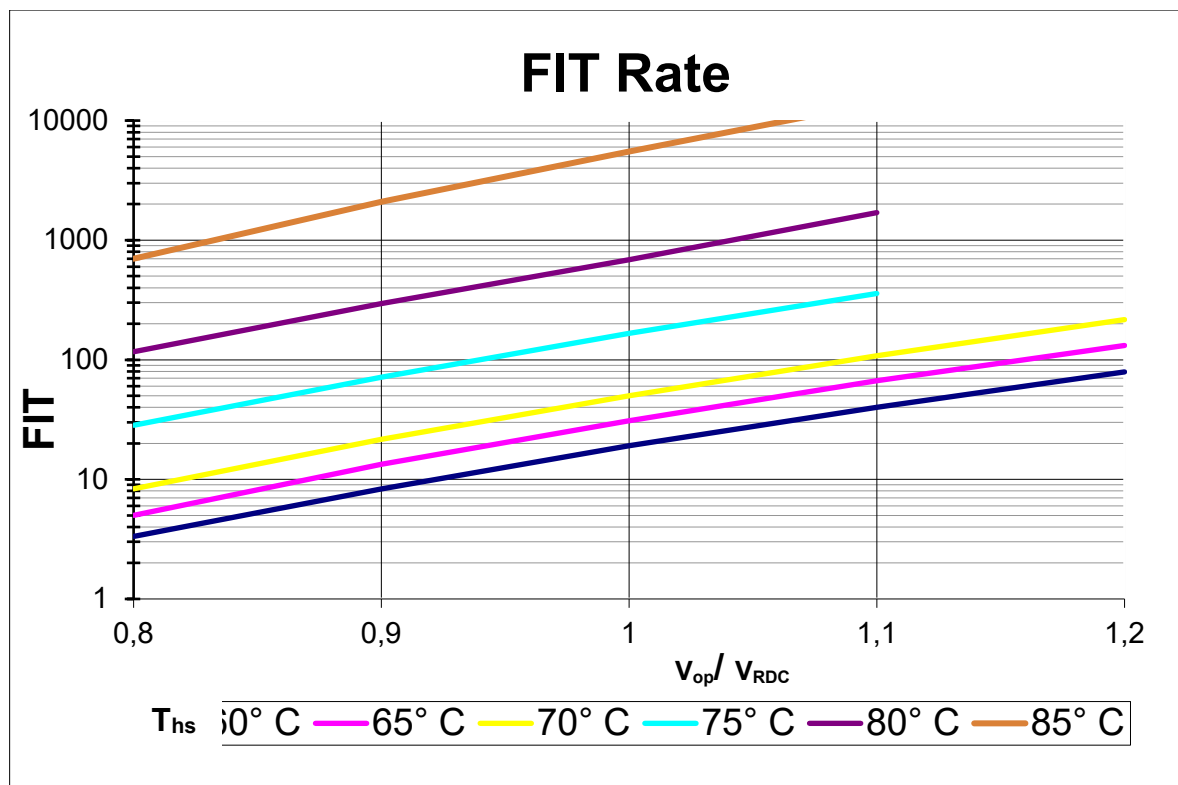

Expected Fit rate at different hot spot temperatures (T_{hs}) and voltage V_{RDC}

The FIT (Failure In Time) of a component is defined as the number of expected failures in 10^9 hours of operation. The FIT rate is calculated on the basis of the number of components operating in the field and the estimated hours of operation. All the reports of failures are taken into consideration for this calculation, which is updated every year.

The other values in the graph are given as indication and calculated based on acceleration factors.

Cautions and warnings

- In case of dents of more than 1 mm depth or any other mechanical damage, capacitors must not be used at all.
- The energy stored in capacitors may be lethal. To prevent any chance of shock, discharge and short-circuit the capacitor before handling.
- Failure to follow cautions may result, worst case, in premature failures, bursting and fire.
- Protect the capacitor properly against over current and short circuit.
- TDK Electronics is not responsible for any kind of possible damages to persons or things due to improper installation and application of capacitors for power electronics.

General safety notes for installation and operation

Electrical or mechanical misapplication of capacitors may be hazardous. Personal injury or property damage may result from bursting of the capacitor or from expulsion melted material due to mechanical disruption of the capacitor.

- Ensure good, effective grounding for capacitor enclosures.
- Observe appropriate safety precautions during operation (self-recharging phenomena and the high energy contained in capacitors).
- Handle capacitors carefully, because they may still be charged even after disconnection.
- The terminals of capacitors, connected bus bars and cables as well as other devices may also be energized.
- Follow good engineering practice.

Thermal load

After installation of the capacitor it is necessary to verify that maximum hot-spot temperature is not exceeded at extreme service conditions.

Installation

Capacitors must be installed in a cool and well ventilated place, and not close to objects that radiate heat, or in the direct sunlight. Within high-power inverter systems the capacitors usually produce the smallest portion of the total losses, and the permissible operating temperatures are low compared to power semiconductors, reactors and resistors. So, the distance between capacitor and heating sources must be large enough to avoid the capacitor overheating. In case of space constraint to make the best possible use of capacitors, technically and economically, it is advisable to supply forced cooling air.

Mechanical protection

The capacitor has to be installed in a way that mechanical damages and dents in the aluminum can are avoided.

Connecting

Ensure firm fixing of terminals, fixing torque to be applied as per individual specification. In any case, the maximum specified terminal current may not be exceeded. Please refer to the technical data of the specific series.

Grounding

The threaded bottom stud of the capacitor has to be used for grounding. In case grounding is done via metal chassis that the capacitor is mounted to, the layer of varnish beneath the washer and nut should be removed. The maximum tightening torque is 10 Nm.

Maintenance

Disregarding the following measures may result in severe operation failures, bursting and fire:

- Check tightness of the connections/terminals periodically, two weeks after installation at the latest, and then once every 6 months.
- Clean the terminals/bushings periodically to avoid short circuits due dust or other contamination.
- Take current reading twice a year and compare with nominal current. Use a harmonic analyser or true effective RMS-meter.
- In case of a current above the nominal current check your application for modification.
- Check the temperature of energized capacitors. In case of excessive temperature of individual capacitors, it is recommended to replace this capacitor, as this could be an indication for loss factor increase, which is a sign for reaching end of life.
- When power capacitors are used, suitable measures must always be taken to eliminate possible danger to humans, animals and property both during operation and when a failure occurs. This applies to capacitors both with and without protective devices. Regular inspection and maintenance by a competent person is therefore essential.

Storage and operating conditions

Do not use or store capacitors in corrosive atmosphere, especially where chloride gas, sulfide gas, acid, alkali, salt or the like are present. In dusty environments regular maintenance and cleaning especially of the terminals is required to avoid conductive path between phases and/or phases and ground.

Service life expectancy

Electrical components do not have an unlimited service life expectancy; this applies to self-healing capacitors, too. The maximum service life expectancy may vary depending on the application the capacitor is used in.

Handling

Discharge and short circuit the capacitor before handling! When handling the capacitor, do not take the capacitor from the terminal. This can cause accident in case the capacitor is charged, terminal break and capacitance loss due to capacitor is heavy.

Important notes

The following applies to all products named in this publication:

1. Some parts of this publication contain **statements about the suitability of our products for certain areas of application**. These statements are based on our knowledge of typical requirements that are often placed on our products in the areas of application concerned. We nevertheless expressly point out **that such statements cannot be regarded as binding statements about the suitability of our products for a particular customer application**. As a rule we are either unfamiliar with individual customer applications or less familiar with them than the customers themselves. For these reasons, it is always ultimately incumbent on the customer to check and decide whether a product with the properties described in the product specification is suitable for use in a particular customer application.
2. We also point out that **in individual cases, a malfunction of electronic components or failure before the end of their usual service life cannot be completely ruled out in the current state of the art, even if they are operated as specified**. In customer applications requiring a very high level of operational safety and especially in customer applications in which the malfunction or failure of an electronic component could endanger human life or health (e.g. in accident prevention or life-saving systems), it must therefore be ensured by means of suitable design of the customer application or other action taken by the customer (e.g. installation of protective circuitry or redundancy) that no injury or damage is sustained by third parties in the event of malfunction or failure of an electronic component.
3. **The warnings, cautions and product-specific notes must be observed.**
4. In order to satisfy certain technical requirements, **some of the products described in this publication may contain substances subject to restrictions in certain jurisdictions (e.g. because they are classed as hazardous)**. Useful information on this will be found in our Material Data Sheets on the Internet (www.tdk-electronics.tdk.com/material). Should you have any more detailed questions, please contact our sales offices.
5. We constantly strive to improve our products. Consequently, **the products described in this publication may change from time to time**. The same is true of the corresponding product specifications. Please check therefore to what extent product descriptions and specifications contained in this publication are still applicable before or when you place an order.

We also **reserve the right to discontinue production and delivery of products**. Consequently, we cannot guarantee that all products named in this publication will always be available. The aforementioned does not apply in the case of individual agreements deviating from the foregoing for customer-specific products.

6. Unless otherwise agreed in individual contracts, **all orders are subject to our General Terms and Conditions of Supply**.
7. **Our manufacturing sites serving the automotive business apply the IATF 16949 standard**. The IATF certifications confirm our compliance with requirements regarding the quality management system in the automotive industry. Referring to customer requirements and customer specific requirements ("CSR") TDK always has and will continue to have the policy of respecting individual agreements. Even if IATF 16949 may appear to support the acceptance of unilateral requirements, we hereby like to emphasize that **only requirements mutually agreed upon can and will be implemented in our Quality Management System**. For clarification purposes we like to point out that obligations from IATF 16949 shall only become legally binding if individually agreed upon.



Important notes

8. The trade names EPCOS, CarXield, CeraCharge, CeraDiode, CeraLink, CeraPad, CeraPlas, CSMP, CTVS, DeltaCap, DigiSiMic, ExoCore, FilterCap, FormFit, LeaXield, MiniBlue, MiniCell, MKD, MKK, ModCap, MotorCap, PCC, PhaseCap, PhaseCube, PhaseMod, PhiCap, PowerHap, PQSine, PQvar, SIFERRIT, SIFI, SIKOREL, SilverCap, SIMDAD, SiMic, SIMID, SineFormer, SIOV, ThermoFuse, WindCap, XieldCap are **trademarks registered or pending** in Europe and in other countries. Further information will be found on the Internet at www.tdk-electronics.tdk.com/trademarks.

Release 2020-06

Looking for pricing, stock, or lifecycle information?

Click below to explore more details on WIN SOURCE:

-  [View B25620B1947K103 on WIN SOURCE](#)
-  [EPCOS \(TDK\) Information](#)

Optimize Your Supply Chain with WIN SOURCE Solutions

-  Global Sourcing Solution
-  Obsolete Management
-  Cost Control Management
-  Shortage Management
-  Alternative Solution
-  Excess Inventory Management