



**THE DATASHEET OF  
DCP4L054007ID4MSSD**



# WIMA DC-LINK MKP 4



**Metallized Polypropylene (PP) - Capacitors for DC-Link Applications.**  
**Capacitances from 1.0 µF to 400 µF.**  
**Rated Voltages from 400 VDC to 1500 VDC.**

## Special Features

- Capacitances up to 400 µF
- High volume/capacitance ratio
- Excellent self-healing properties
- Very low dissipation factor
- High reliability
- 2-pin, 4-pin or plate contact configuration
- AEC-Q200 qualified
- According to RoHS 2015/863/EU

## Typical Applications

As intermediate circuit capacitor e.g. in high power converter technology, power supplies, solar inverters, e-mobility (battery chargers, motor drives & power train) etc.

## Construction

### Dielectric:

Polypropylene (PP) film

### Capacitor electrodes:

Vacuum-deposited

### Internal construction:

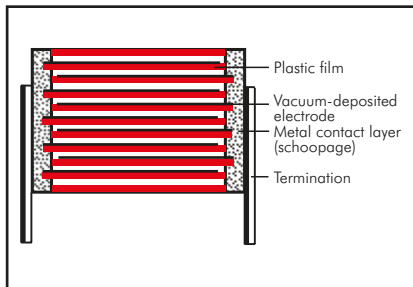

### Encapsulation:

Solvent-resistant, flame-retardant plastic case with epoxy resin seal, UL 94 V-0

### Terminations:

Tinned wire or plates.

### Marking:

Colour: Red. Marking: Black.

## Packing

Packing units at the end of the catalogue

## Electrical Data

**Capacitance range:** 1 µF to 400 µF (intermediate values on request)

**Rated voltages:** 400VDC, 500VDC, 600VDC, 800VDC, 900VDC, 1100VDC, 1300VDC, 1500VDC

**Capacitance tolerances:** ±20%, ±10%, ±5%

**Operating temperature range:** -55° C to +105° C (hot spot including self-heating)

**Climatic test category:** 55/085/56 in accordance with IEC

**Insulation resistance at +20° C:** ≥ 30 000 sec (MΩ x µF)

Measuring voltage: 100 V/1 min.

**Dielectric absorption:** 0.05 %

### Voltage and current derating:

A derating factor of 1.35% per K must be applied from +85° C for DC voltages and from +70° C for AC currents ( $I_{rms}$ ). Additionally a derating factor of 4.5% per K must be applied from +85° C for AC currents ( $I_{rms}$ )

**Reliability:** Operational life > 100 000 hours ( $U_r$  and 70° C)

Failure rate  $\lambda_0$  (0.5 x  $U_r$  and 40° C)

$\Pi =  C_N [\mu F] \times U_r [V] $	$\lambda_0$
$\Pi \leq 10\,000$	< 2 fit
$10\,000 < \Pi \leq 25\,000$	< 5 fit
$25\,000 < \Pi \leq 50\,000$	< 10 fit
$50\,000 < \Pi \leq 100\,000$	< 20 fit
$\Pi > 100\,000$	< 30 fit

### Test voltage:

≤ 500 VDC: 1.5  $U_r$ , 2sec

> 500 VDC: 1.2  $U_r$ , 2sec

### Specific dissipation:

Box size WxHxL in mm	Specific dissipation in Watts per K above the ambient temperature
9x19x31.5	0.021
11x21x31.5	0.025
13x24x31.5	0.030
15x26x31.5	0.034
17x29x31.5	0.039
17x34.5x31.5	0.044
20x39.5x31.5	0.053
13x24x41.5	0.037
15x26x41.5	0.042
17x29x41.5	0.048
19x32x41.5	0.054
20x39.5x41.5	0.065
24x45.5x41.5	0.080
28x38x41.5	0.076
31x46x41.5	0.092
35x50x41.5	0.106
40x55x41.5	0.123
25x45x57	0.102
30x45x57	0.113
35x50x57	0.132
45x55x57	0.164
45x65x57	0.184

For further details and graphs please refer to Technical Information.

### Dissipation factors at +20° C: $\tan \delta \times 10^{-4}$

PCM	400VDC		500VDC		600VDC		800VDC		900VDC		1100VDC		1300VDC		1500VDC	
	1kHz	10kHz	1kHz	10kHz	1kHz	10kHz	1kHz	10kHz	1kHz	10kHz	1kHz	10kHz	1kHz	10kHz	1kHz	10kHz
27.5	15	160	15	130	12	120	10	90	10	80	10	60	7	50	7	40
37.5	60	350	30	240	21	150	18	170	16	150	14	100	12	90	12	90
52.5	80	550	80	460	40	300	35	250	31	200	30	170	23	150	23	150

### Maximum pulse rise time:

PCM	max. pulse rise time V/µsec at $T_A < 40^\circ C$								
	400VDC	500VDC	600VDC	800VDC	900VDC	1100VDC	1300VDC	1500VDC	
27.5	11	15	27	29	35	43	50	59	
37.5	8	10	19	21	22	29	35	41	
52.5	5	7	13	15	18	21	25	29	

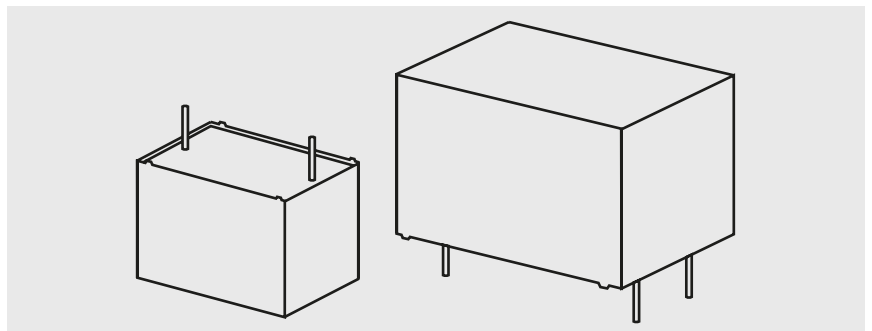



## Continuation

### General Data

Capacitance	400 VDC (70° C) / 300 VDC (85° C) / 220 VDC (105° C)								Part number
	W	H	L	PCM**	Pin	I <sub>S</sub> A	I <sub>rms</sub> * (10 kHz)* A	ESR (10 kHz)* mΩ	
1 μF	9	19	31.5	27.5	2	11	1	238.7	DCP4G041006A
2 "	9	19	31.5	27.5	2	22	1.5	119.4	DCP4G042006A
3 "	9	19	31.5	27.5	2	33	1.5	79.6	DCP4G043006A
4 "	9	19	31.5	27.5	2	44	2	59.7	DCP4G044006A
5 "	9	19	31.5	27.5	2	55	2	47.7	DCP4G045006A
7 "	9	19	31.5	27.5	2	77	2.5	34.1	DCP4G047006A
10 μF	11	21	31.5	27.5	2/4	110	3.5	23.9	DCP4G051006B
15 "	13	24	31.5	27.5	2/4	165	4.5	15.9	DCP4G051506D
20 "	15	26	31.5	27.5	2/4	220	5.5	11.9	DCP4G052006F
22 "	17	29	31.5	27.5	2/4	242	6	9.8	DCP4G052206G
25 "	17	29	31.5	27.5	2/4	275	7	8.6	DCP4G052506G
	15	26	41.5	37.5	2/4	200	6.5	10	DCP4G052507D
30 "	17	34.5	31.5	27.5	2/4	330	8	7.2	DCP4G053006I
	17	29	41.5	37.5	2/4	240	7.5	8.5	DCP4G053007E
40 "	20	39.5	31.5	27.5	2/4	440	10	5.4	DCP4G054006J
	19	32	41.5	37.5	2/4	320	9.5	6	DCP4G054007F
50 "	20	39.5	41.5	37.5	2/4	400	11	5.4	DCP4G055007G
60 "	20	39.5	41.5	37.5	2/4	480	11.5	4.8	DCP4G056007G
70 "	24	45.5	41.5	37.5	2/4	560	13	4.7	DCP4G057007H
80 "	24	45.5	41.5	37.5	2/4	640	14	4.1	DCP4G058007H
90 "	24	45.5	41.5	37.5	2/4	720	15	3.6	DCP4G059007H
	28	38	41.5	37.5	2/4	720	15	3.6	DCP4G059007L
100 μF	31	46	41.5	37.5	2/4	800	18	2.8	DCP4G061007I
120 "	31	46	41.5	37.5	2/4	960	20	2.3	DCP4G061207I
140 "	35	50	41.5	37.5	2/4	1120	22.5	2.1	DCP4G061407J
150 "	35	50	41.5	37.5	2/4	1200	23	2	DCP4G061507J
	25	45	57	52.5	4	750	20	2.6	DCP4G061509D
160 "	40	55	41.5	37.5	2/4	1280	24.5	2	DCP4G061607K
	25	45	57	52.5	4	800	21	2.3	DCP4G061609D
180 "	40	55	41.5	37.5	2/4	1440	26	1.8	DCP4G061807K
	30	45	57	52.5	4	900	23.5	2	DCP4G061809E
200 "	40	55	41.5	37.5	2/4	1600	27.5	1.6	DCP4G062007K
	30	45	57	52.5	4	1000	25	1.8	DCP4G062009E
220 "	35	50	57	52.5	4	1100	27	1.8	DCP4G062209F
250 "	45	55	57	52.5	4	1250	32	1.6	DCP4G062509H
270 "	45	55	57	52.5	4	1350	33.5	1.5	DCP4G062709H
300 "	45	55	57	52.5	4	1500	35	1.3	DCP4G063009H
330 "	45	65	57	52.5	4	1650	37	1.2	DCP4G063309J
350 "	45	65	57	52.5	4	1750	40	1.1	DCP4G063509J
370 "	45	65	57	52.5	4	1850	41.5	1.1	DCP4G063709J
400 "	45	65	57	52.5	4	2000	43	1	DCP4G064009J

\* General guide

\* Permissible I<sub>rms</sub> at 10° C internal temperature rise (general guide)

\*\* PCM = Printed circuit module = pin spacing

Dims. in mm.

Part number completion:

Version code:	2-pin	= D2
	4-pin	= D4
Tolerance:	20 %	= M
	10 %	= K
	5 %	= J
Packing:	bulk	= S
Pin length:	6-2	= SD
Taped version see page 157.		

Rights reserved to amend design data without prior notification.

Continuation page 131

## Continuation

### General Data

Capacitance	500 VDC (70° C) / 400 VDC (85° C) / 290 VDC (105° C)								Part number
	W	H	L	PCM**	Pin	I <sub>s</sub> A	I <sub>rms</sub> * (10 kHz)* A	ESR (10 kHz)* mΩ	
1 μF	9	19	31.5	27.5	2	15	1	238.7	DCP4H141006A
2 "	9	19	31.5	27.5	2	30	1.5	119.4	DCP4H142006A
3 "	9	19	31.5	27.5	2	45	1.5	79.6	DCP4H143006A
4 "	9	19	31.5	27.5	2	60	1.8	63.7	DCP4H144006A
5 "	9	19	31.5	27.5	2	75	2.5	47.7	DCP4H145006A
7 "	11	21	31.5	27.5	2/4	105	3	34.1	DCP4H147006B
8 "	13	24	31.5	27.5	2/4	120	3	29.8	DCP4H148006D
10 μF	13	24	31.5	27.5	2/4	150	4	23.9	DCP4H151006D
12 "	15	26	31.5	27.5	2/4	180	4	19.9	DCP4H151206F
15 "	17	29	31.5	27.5	2/4	225	5	15.9	DCP4H151506G
	15	26	41.5	37.5	2/4	150	4.3	22.3	DCP4H151507D
18 "	17	29	31.5	27.5	2/4	270	6	9.5	DCP4H151806G
20 "	17	34.5	31.5	27.5	2/4	300	6	11.9	DCP4H152006I
	17	29	41.5	37.5	2/4	200	5.4	16.8	DCP4H152007E
22 "	20	39.5	31.5	27.5	2/4	330	7	10.9	DCP4H152206J
25 "	20	39.5	31.5	27.5	2/4	375	7.5	9.5	DCP4H152506J
	19	32	41.5	37.5	2/4	250	6.3	13.4	DCP4H152507F
30 "	20	39.5	41.5	37.5	2/4	300	9	7.9	DCP4H153007G
35 "	20	39.5	41.5	37.5	2/4	350	8.5	9.1	DCP4H153507G
40 "	20	39.5	41.5	37.5	2/4	400	10	5.7	DCP4H154007G
50 "	24	45.5	41.5	37.5	2/4	500	13	4.8	DCP4H155007H
	28	38	41.5	37.5	2/4	500	13	4.8	DCP4H155007L
55 "	24	45.5	41.5	37.5	2/4	550	14	4	DCP4H155507H
	28	38	41.5	37.5	2/4	550	14	4	DCP4H155507L
60 "	31	46	41.5	37.5	2/4	600	14	4.7	DCP4H156007I
70 "	31	46	41.5	37.5	2/4	700	16.5	3.9	DCP4H157007I
80 "	31	46	41.5	37.5	2/4	800	17.5	3.4	DCP4H158007I
90 "	35	50	41.5	37.5	2/4	900	19	3	DCP4H159007J
100 μF	35	50	41.5	37.5	2/4	1000	20	2.7	DCP4H161007J
	25	45	57	52.5	4	700	14.3	5	DCP4H161009D
120 "	40	55	41.5	37.5	2/4	1200	22.5	2.7	DCP4H161207K
	30	45	57	52.5	4	840	16.5	4.2	DCP4H161209E
130 "	40	55	41.5	37.5	2/4	1300	23	2.4	DCP4H161307K
140 "	35	50	57	52.5	4	980	21.5	2.8	DCP4H161409F
150 "	35	50	57	52.5	4	1050	22.5	2.7	DCP4H161509F
160 "	45	55	57	52.5	4	1120	25.5	2.5	DCP4H161609H
180 "	45	55	57	52.5	4	1260	27	2.2	DCP4H161809H
200 "	45	55	57	52.5	4	1400	28.5	2	DCP4H162009H
210 "	45	55	57	52.5	4	1470	29.5	1.9	DCP4H162109H
220 "	45	65	57	52.5	4	1540	32	1.8	DCP4H162209J
240 "	45	65	57	52.5	4	1680	33.5	1.7	DCP4H162409J

\* General guide

\* Permissible I<sub>rms</sub> at 10° C internal temperature rise (general guide)

\*\* PCM = Printed circuit module = pin spacing

Dims. in mm.

Rights reserved to amend design data without prior notification.

Part number completion:	
Version code:	2-pin = D2
	4-pin = D4
Tolerance:	20 % = M
	10 % = K
	5 % = J
Packing:	bulk = S
Pin length:	6-2 = SD
Taped version see page 157.	

Continuation page 132

## Continuation

### General Data

Capacitance	600 VDC (70° C) / 450 VDC (85° C) / 320 VDC (105° C)								
	W	H	L	PCM**	Pin	$I_s$ A	$I_{rms}^*$ (10 kHz)* A	ESR (10 kHz)* mΩ	Part number
1 μF	9	19	31.5	27.5	2	27	1.5	106.9	DCP4I041006A
2 "	9	19	31.5	27.5	2	54	2	56	DCP4I042006A
3 "	9	19	31.5	27.5	2	81	2.5	35.6	DCP4I043006A
4 "	11	21	31.5	27.5	2/4	108	3	26.7	DCP4I044006B
5 "	13	24	31.5	27.5	2/4	135	3.5	22	DCP4I045006D
7 "	15	26	31.5	27.5	2/4	189	4.5	16	DCP4I047006F
8 "	15	26	31.5	27.5	2/4	216	5	13.4	DCP4I048006F
10 μF	17	29	31.5	27.5	2/4	270	6	11	DCP4I051006G
	13	24	41.5	37.5	2/4	190	5	17.6	DCP4I051007C
12 "	17	29	31.5	27.5	2/4	324	6.5	8.9	DCP4I051206G
15 "	17	34.5	31.5	27.5	2/4	405	8	7	DCP4I051506I
	17	29	41.5	37.5	2/4	285	6.5	11.8	DCP4I051507E
18 "	20	39.5	31.5	27.5	2/2	486	9.5	5.9	DCP4I051806J
20 "	20	39.5	31.5	27.5	2/4	540	10	5.3	DCP4I052006J
	19	32	41.5	37.5	2/4	380	10.5	4.9	DCP4I052007F
22 "	20	39.5	41.5	37.5	2/4	418	11	5.4	DCP4I052207G
25 "	20	39.5	41.5	37.5	2/4	475	11.5	5	DCP4I052507G
30 "	24	45.5	41.5	37.5	2/4	570	14	4.1	DCP4I053007H
35 "	24	45.5	41.5	37.5	2/4	665	14.5	3.8	DCP4I053507H
	28	38	41.5	37.5	2/4	665	14.5	3.8	DCP4I053507L
40 "	31	46	41.5	37.5	2/4	760	16.5	3.3	DCP4I054007I
45 "	31	46	41.5	37.5	2/4	855	17	3.2	DCP4I054507I
50 "	35	50	41.5	37.5	2/4	950	19	2.9	DCP4I055007J
60 "	35	50	41.5	37.5	2/4	1140	17.5	3.4	DCP4I056007J
	25	45	57	52.5	2/4	780	14.5	4.9	DCP4I056009D
70 "	40	55	41.5	37.5	2/4	1330	20	3.1	DCP4I057007K
	30	45	57	52.5	4	910	16.5	4.2	DCP4I057009E
80 "	40	55	41.5	37.5	2/4	1520	22	2.6	DCP4I058007K
	30	45	57	52.5	4	1040	17.8	3.6	DCP4I058009E
90 "	35	50	57	52.5	4	1170	23.5	1.9	DCP4I059009F
100 μF	45	55	57	52.5	4	1300	25	2.6	DCP4I061009H
120 "	45	65	57	52.5	4	1560	28	2.3	DCP4I061209J
140 "	45	65	57	52.5	4	1820	31	1.9	DCP4I061409J
150 "	45	65	57	52.5	4	1950	33	1.7	DCP4I061509J

\* General guide

\* Permissible  $I_{rms}$  at 10° C internal temperature rise (general guide)

\*\* PCM = Printed circuit module = pin spacing

Dims. in mm.

Part number completion:	
Version code:	2-pin = D2
	4-pin = D4
Tolerance:	20 % = M
	10 % = K
	5 % = J
Packing:	bulk = S
Pin length:	6-2 = SD
Taped version see page 157.	

#### 2-pin version

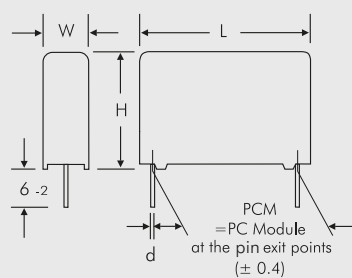

#### 4-pin version

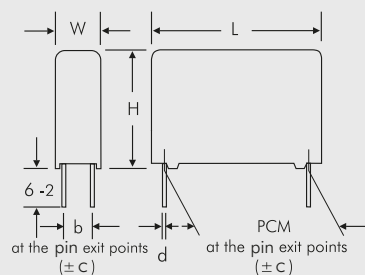

Rights reserved to amend design data without prior notification.

## Continuation

### General Data

Capacitance	800 VDC (70° C) / 700 VDC (85° C) / 510 VDC (105° C)					$I_s$ A	$I_{rms}^*$ (10 kHz)* A	ESR (10 kHz)* mΩ	Part number
	W	H	L	PCM**	Pin				
1 μF	9	19	31.5	27.5	2	29	1.7	73.2	DCP4L041006A
2 "	9	19	31.5	27.5	2	58	2.5	36.6	DCP4L042006A
3 "	11	21	31.5	27.5	2/4	87	3	24.4	DCP4L043006B
4 "	13	24	31.5	27.5	2/4	116	4	18.3	DCP4L044006D
5 "	13	24	31.5	27.5	2/4	145	4.5	14.6	DCP4L045006D
7 "	17	29	31.5	27.5	2/4	203	6	10.5	DCP4L047006G
8 "	17	29	31.5	27.5	2/4	232	6.5	9.2	DCP4L048006G
10 μF	17	34.5	31.5	27.5	2/4	290	8	7.3	DCP4L051006I
	17	29	41.5	37.5	2/4	210	7.5	8.5	DCP4L051007E
12 "	20	39.5	31.5	27.5	2/4	348	9.5	6.1	DCP4L051206J
15 "	20	39.5	31.5	27.5	2/4	435	10.5	4.9	DCP4L051506J
	19	32	41.5	37.5	2/4	315	8.5	7.5	DCP4L051507F
18 "	20	39.5	41.5	37.5	2/4	378	9.5	7.2	DCP4L051807G
20 "	20	39.5	41.5	37.5	2/4	420	10	6.2	DCP4L052007G
22 "	20	39.5	41.5	37.5	2/4	462	10.5	5.9	DCP4L052207G
25 "	24	45.5	41.5	37.5	2/4	525	12.5	5	DCP4L052507H
30 "	24	45.5	41.5	37.5	2/4	630	14	4.1	DCP4L053007H
	28	38	41.5	37.5	2/4	630	14	4.1	DCP4L053007L
35 "	31	46	41.5	37.5	2/4	735	15.5	3.8	DCP4L053507I
40 "	31	46	41.5	37.5	2/4	840	16.5	3.3	DCP4L054007I
45 "	35	50	41.5	37.5	2/4	945	17.5	3.4	DCP4L054507J
50 "	35	50	41.5	37.5	2/4	1050	19	3	DCP4L055007J
	25	45	57	52.5	4	750	18.5	3	DCP4L055009D
60 "	40	55	41.5	37.5	2/4	1260	21.5	2.7	DCP4L056007K
	30	45	57	52.5	4	900	20.5	2.7	DCP4L056009E
65 "	35	50	57	52.5	4	975	22.5	2.2	DCP4L056509F
70 "	45	55	57	52.5	4	1050	23.5	3	DCP4L057009H
75 "	45	55	57	52.5	4	1125	24	2.9	DCP4L057509H
80 "	45	55	57	52.5	4	1200	24.5	3	DCP4L058009H
90 "	45	65	57	52.5	4	1350	25.5	2.5	DCP4L059009J
100 μF	45	65	57	52.5	4	1500	26.5	2.3	DCP4L061009J
115 "	45	65	57	52.5	4	1725	28	2.1	DCP4L061159J

\* General guide

\* Permissible  $I_{rms}$  at 10° C internal temperature rise (general guide)

\*\* PCM = Printed circuit module = pin spacing

Dims. in mm.

Part number completion:	
Version code:	2-pin = D2 4-pin = D4
Tolerance:	20 % = M 10 % = K 5 % = J
Packing:	bulk = S
Pin length:	6-2 = SD
Taped version see page 157.	

#### 2-pin version

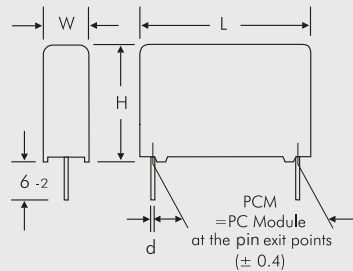

PCM	Ød
27.5	0.8
37.5	1

#### 4-pin version

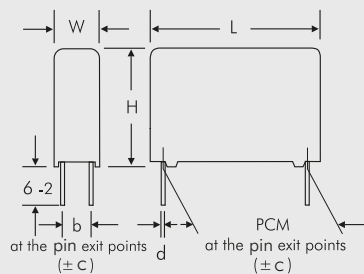

W	PCM	b	Ød	c
11	27.5	5	0.8	0.4
13	27.5	7.5	0.8	0.4
15	27.5	7.5	0.8	0.4
17	27.5	10	0.8	0.4
20	27.5	12.5	0.8	0.4
19	37.5	10	1	0.4
20	37.5	12.5	1	0.4
24	37.5	12.5	1	0.4
28	37.5	10	1	0.4
31	37.5	20	1	0.4
35	37.5	20	1	0.4
40	37.5	20	1	0.4
25	52.5	12.5	1.2	0.8
30	52.5	20	1.2	0.8
35	52.5	20	1.2	0.8
45	52.5	20	1.2	0.8

Rights reserved to amend design data without prior notification..



## Continuation

### General Data

Capacitance	900 VDC (70° C) / 760 VDC (85° C) / 550 VDC (105° C)								
	W	H	L	PCM**	Pin	$I_S$ A	$I_{rms}^*$ (10 kHz)* A	ESR (10 kHz)* mΩ	Part number
1 μF	9	19	31.5	27.5	2	35	2	66.1	DCP4N041006A_____
2 "	11	21	31.5	27.5	2/4	70	2.5	44	DCP4N042006B_____
3 "	13	24	31.5	27.5	2/4	105	4	22	DCP4N043006D_____
4 "	13	24	31.5	27.5	2/4	140	4.5	16.5	DCP4N044006D_____
5 "	17	29	31.5	27.5	2/4	175	4.5	18	DCP4N045006G_____
7 "	17	29	31.5	27.5	2/4	245	6.5	9.4	DCP4N047006G_____
8 "	17	34.5	31.5	27.5	2/4	280	7.5	8.3	DCP4N048006I_____
10 μF	20	39.5	31.5	27.5	2/4	350	10	5.3	DCP4N051006J_____
	19	32	41.5	37.5	2/4	220	9	6.7	DCP4N051007F_____
15 "	20	39.5	41.5	37.5	2/4	330	10.5	5.8	DCP4N051507G_____
20 "	24	45.5	41.5	37.5	2/4	440	13	4.8	DCP4N052007H_____
	28	38	41.5	37.5	2/4	440	13	4.8	DCP4N052007L_____
22 "	24	45.5	41.5	37.5	2/4	484	14	4.1	DCP4N052207H_____
	28	38	41.5	37.5	2/4	484	14	4.1	DCP4N052207L_____
25 "	31	46	41.5	37.5	2/4	550	15.5	3.8	DCP4N052507I_____
30 "	31	46	41.5	37.5	2/4	660	16.5	3.4	DCP4N053007I_____
	25	45	57	52.5	4	540	15	4.5	DCP4N053009D_____
35 "	35	50	41.5	37.5	2/4	770	18	3.2	DCP4N053507J_____
	25	45	57	52.5	4	630	16	4	DCP4N053509D_____
40 "	40	55	41.5	37.5	2/4	880	19.5	3.2	DCP4N054007K_____
	30	45	57	52.5	4	720	18	3.5	DCP4N054009E_____
50 "	35	50	57	52.5	4	900	22	3.3	DCP4N055009F_____
60 "	45	55	57	52.5	4	1080	23	3	DCP4N056009H_____
70 "	45	65	57	52.5	4	1260	24.5	3.3	DCP4N057009J_____
80 "	45	65	57	52.5	4	1440	25.5	2.8	DCP4N058009J_____

\* General guide

\* Permissible  $I_{rms}$  at 10° C internal temperature rise (general guide)

\*\* PCM = Printed circuit module = pin spacing

Dims. in mm.

Part number completion:	
Version code:	2-pin = D2 4-pin = D4
Tolerance:	20 % = M 10 % = K 5 % = J
Packing:	bulk = S
Pin length:	6-2 = SD
Taped version see page 157.	

Rights reserved to amend design data without prior notification.

Continuation page 135

## Continuation

### General Data

Capacitance	1100 VDC (70° C) / 920 VDC (85° C) / 670 VDC (105° C)								
	W	H	L	PCM**	Pin	I <sub>S</sub> A	I <sub>rms</sub> * (10 kHz)* A	ESR (10 kHz)* mΩ	Part number
1 μF	9	19	31.5	27.5	2	43	2	86	DCP4P041006A
2 "	13	24	31.5	27.5	2/4	86	4	19	DCP4P042006D
3 "	15	26	31.5	27.5	2/4	129	5	13.6	DCP4P043006F
4 "	17	29	31.5	27.5	2/4	172	6	10.8	DCP4P044006G
5 "	17	34.5	31.5	27.5	2/4	215	7.5	7.8	DCP4P045006I
7 "	20	39.5	31.5	27.5	2/4	301	9	6.5	DCP4P047006J
	19	32	41.5	37.5	2/4	203	7.5	10	DCP4P047007F
8 "	20	39.5	41.5	37.5	2/4	232	8	10	DCP4P048007G
10 μF	20	39.5	41.5	37.5	2/4	290	9.5	7.2	DCP4P051007G
12 "	24	45.5	41.5	37.5	2/4	348	11	6.6	DCP4P051207H
15 "	24	45.5	41.5	37.5	2/4	435	12	5.6	DCP4P051507H
	28	38	41.5	37.5	2/4	435	12	5.6	DCP4P051507L
18 "	31	46	41.5	37.5	2/4	522	13.5	5	DCP4P051807I
20 "	35	50	41.5	37.5	2/4	580	15	4.7	DCP4P052007J
	25	45	57	52.5	4	420	14.5	4.9	DCP4P052009D
22 "	35	50	41.5	37.5	2/4	638	15.5	4.4	DCP4P052207J
	25	45	57	52.5	4	462	15	4.5	DCP4P052209D
25 "	40	55	41.5	37.5	2/4	725	16.5	4.6	DCP4P052507K
	30	45	57	52.5	4	525	16	4.4	DCP4P052509E
30 "	35	50	57	52.5	4	630	17.5	4.4	DCP4P053009F
35 "	35	50	57	52.5	4	735	18	4	DCP4P053509F
40 "	35	50	57	52.5	4	840	18	4.3	DCP4P054009F
45 "	45	55	57	52.5	4	945	20	4.1	DCP4P054509H
50 "	45	65	57	52.5	4	1050	21	4.1	DCP4P055009J
60 "	45	65	57	52.5	4	1260	23	3.5	DCP4P056009J

Capacitance	1300 VDC (70° C) / 1100 VDC (85° C) / 800 VDC (105° C)								
	W	H	L	PCM**	Pin	I <sub>S</sub> A	I <sub>rms</sub> * (10 kHz)* A	ESR (10 kHz)* mΩ	Part number
1 μF	11	21	31.5	27.5	2/4	50	2.5	40	DCP4R241006B
2 "	15	26	31.5	27.5	2/4	100	4.5	16.8	DCP4R242006F
3 "	17	29	31.5	27.5	2/4	150	6	10.8	DCP4R243006G
4 "	17	34.5	31.5	27.5	2/4	200	6.5	10.4	DCP4R244006I
5 "	20	39.5	31.5	27.5	2/4	250	7.5	9.4	DCP4R245006J
	19	32	41.5	37.5	2/4	175	7	11	DCP4R245007F
7 "	20	39.5	41.5	37.5	2/4	245	8	10	DCP4R247007G
8 "	24	45.5	41.5	37.5	2/4	280	9	9.9	DCP4R248007H
10 μF	24	45.5	41.5	37.5	2/4	350	10.5	7.2	DCP4R251007H
	28	38	41.5	37.5	2/4	350	10.5	7.2	DCP4R251007L
15 "	31	46	41.5	37.5	2/4	525	14	4.8	DCP4R251507I
	25	45	57	52.5	4	375	13	6	DCP4R251509D
18 "	35	50	41.5	37.5	2/4	630	15.5	4.4	DCP4R251807J
	25	45	57	52.5	4	450	14.5	4.9	DCP4R251809D
20 "	40	55	41.5	37.5	2/4	700	17.5	4	DCP4R252007K
	30	45	57	52.5	4	500	16	4.4	DCP4R252009E
22 "	40	55	41.5	37.5	2/4	770	18	3.8	DCP4R252207K
	35	50	57	52.5	4	550	17.5	4.3	DCP4R252209F
25 "	35	50	57	52.5	4	625	19	3.6	DCP4R252509F
30 "	45	55	57	52.5	4	750	20	4	DCP4R253009H
35 "	45	65	57	52.5	4	875	21	4.1	DCP4R253509J
40 "	45	65	57	52.5	4	1000	22	3.7	DCP4R254009J

\* General guide

\*\* PCM = Printed circuit module = pin spacing

\* Permissible I<sub>rms</sub> at 10° C internal temperature rise (general guide)

Dims. in mm.

Rights reserved to amend design data without prior notification.

## Continuation

### General Data

Capacitance	1500 VDC (70° C) / 1200 VDC (85° C) / 870 VDC (105° C)								Part number
	W	H	L	PCM**	Pin	$I_s$ A	$I_{rms}^*$ (10 kHz)* A	ESR (10 kHz)* mΩ	
1 μF	13	24	31.5	27.5	2/4	59	3	33.3	DCP4S041006D
2 "	17	29	31.5	27.5	2/4	118	5	15.6	DCP4S042006G
3 "	19	32	41.5	37.5	2/4	123	6	15	DCP4S043007F
4 "	20	39.5	41.5	37.5	2/4	164	7	13.3	DCP4S044007G
5 "	20	39.5	41.5	37.5	2/4	205	8	10.2	DCP4S045007G
7 "	24	45.5	41.5	37.5	2/4	287	9.5	8.9	DCP4S047007H
	28	38	41.5	37.5	2/4	287	9.5	8.4	DCP4S047007L
8 "	31	46	41.5	37.5	2/4	328	11	7.6	DCP4S048007I
10 μF	31	46	41.5	37.5	2/4	410	12.5	5.9	DCP4S051007I
12 "	35	50	41.5	37.5	2/4	492	14.5	5	DCP4S051207J
	25	45	57	52.5	4	348	14	5.2	DCP4S051209D
15 "	40	55	41.5	37.5	2/4	615	17	4.3	DCP4S051507K
	30	45	57	52.5	4	435	16	4.4	DCP4S051509E
18 "	35	50	57	52.5	4	522	17.5	4.3	DCP4S051809F
20 "	35	50	57	52.5	4	580	18	4.1	DCP4S052009F
22 "	45	55	57	52.5	4	638	20	4.1	DCP4S052209H
25 "	45	55	57	52.5	4	725	20.5	3.9	DCP4S052509H
30 "	45	65	57	52.5	4	870	21.5	4	DCP4S053009J

\* General guide

\* Permissible  $I_{rms}$  at 10° C internal temperature rise (general guide)

\*\* PCM = Printed circuit module = pin spacing

Dims. in mm.

Part number completion:	
Version code:	2-pin = D2 4-pin = D4
Tolerance:	20 % = M 10 % = K 5 % = J
Packing:	bulk = S
Pin length:	6-2 = SD
Taped version see page 157.	

#### 2-pin version

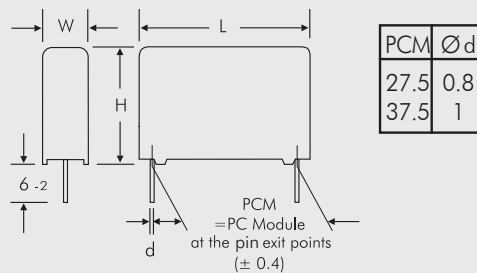

#### 4-pin version

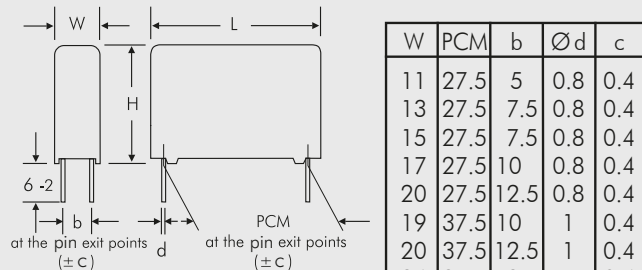

#### Plate versions page 140

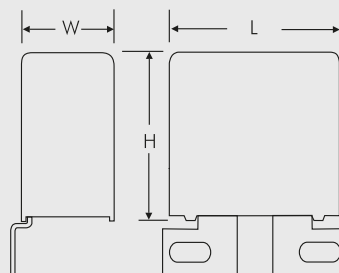

Example

Rights reserved to amend design data without prior notification.

Continuation page 137

## Continuation

### 500 VDC

Impedance change with frequency  
(general guide)

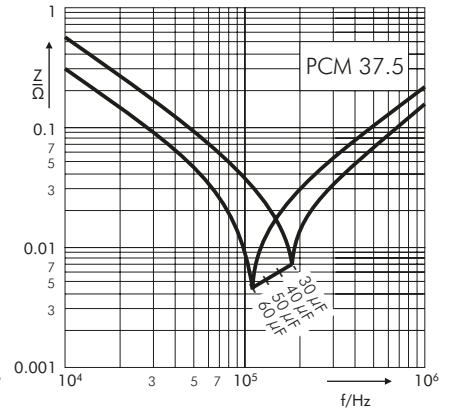
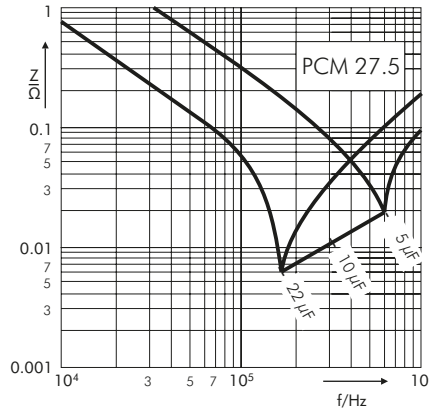

Permissible AC current in relation to  
frequency at  $\leq 20^\circ\text{C}$  internal temperature  
rise (general guide)

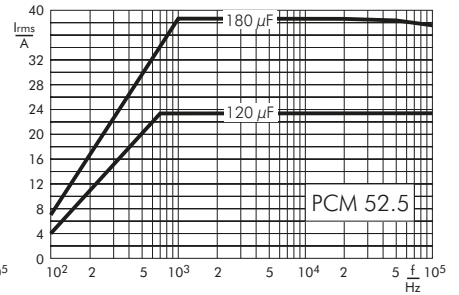
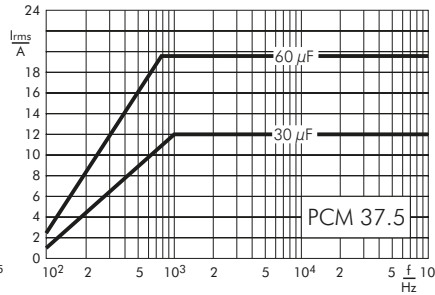
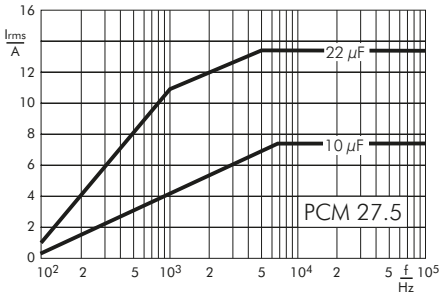

### 600 VDC

Impedance change with frequency  
(general guide)

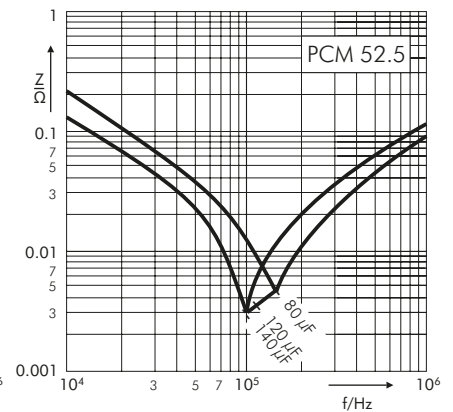
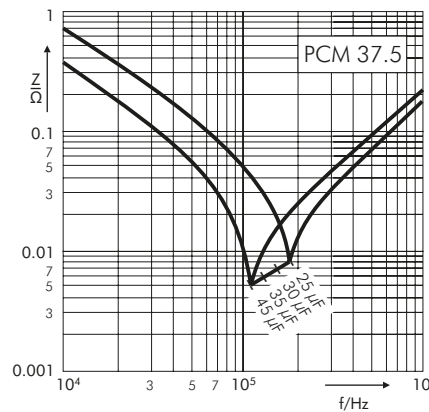

Permissible AC current in relation to  
frequency at  $\leq 20^\circ\text{C}$  internal temperature  
rise (general guide)

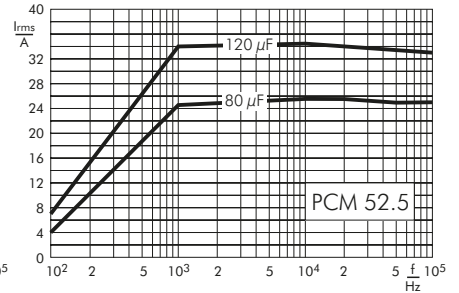
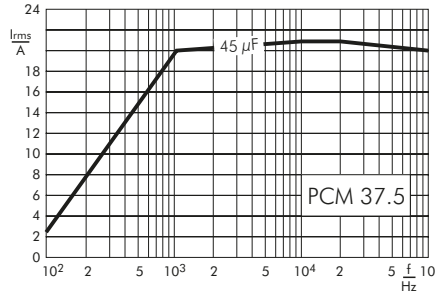

## Continuation

### 800 VDC

Impedance change with frequency (general guide)

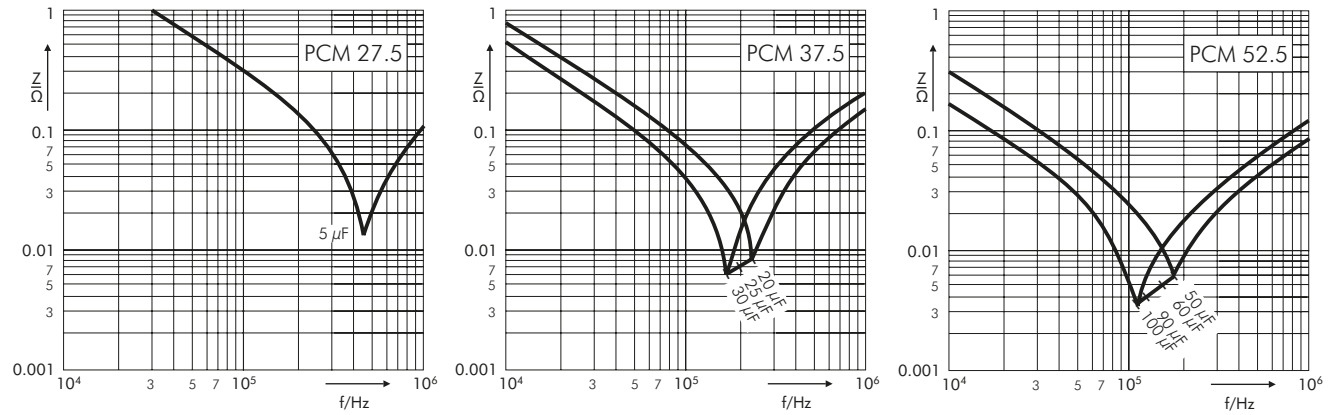

Permissible AC current in relation to frequency at  $\leq 20^\circ\text{C}$  internal temperature rise (general guide)

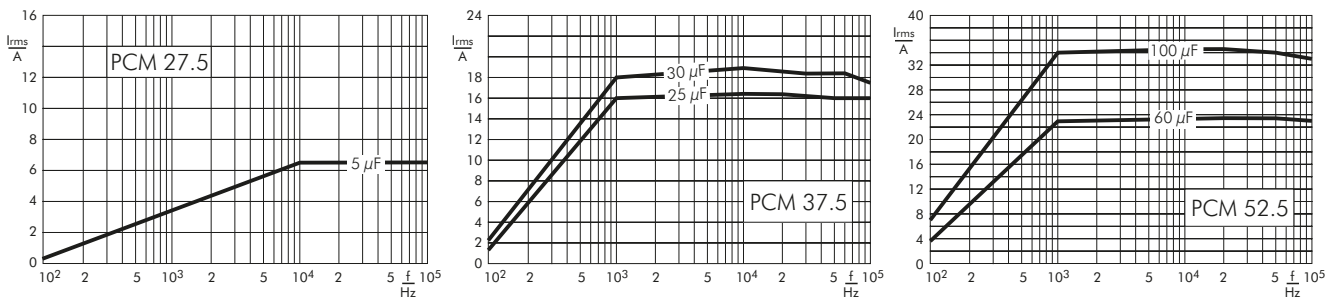

### 900 VDC

Impedance change with frequency (general guide)

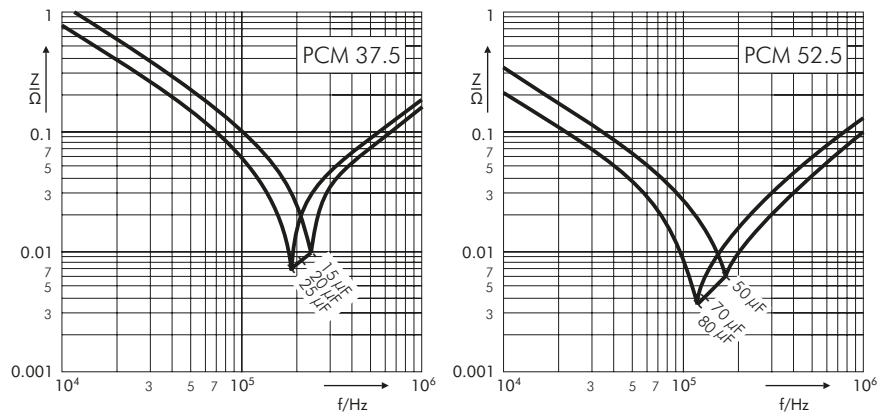

Permissible AC current in relation to frequency at  $\leq 20^\circ\text{C}$  internal temperature rise (general guide)

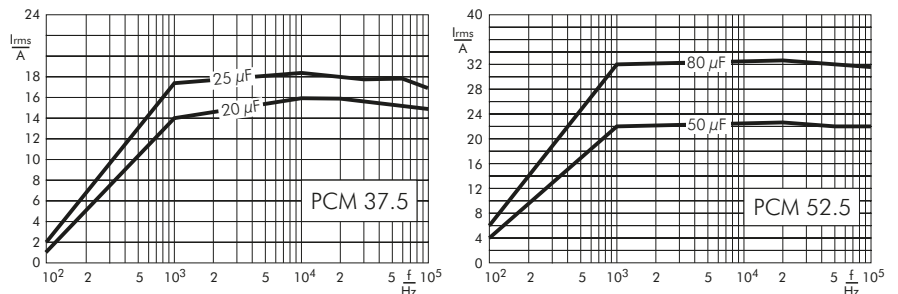

## Continuation

### 1100 VDC

Impedance change with frequency (general guide)

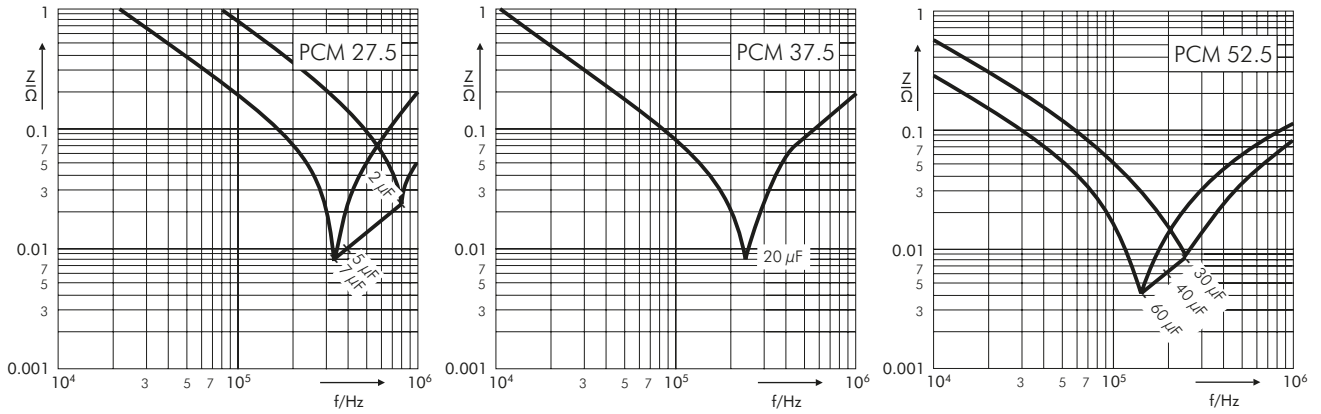

Permissible AC current in relation to frequency at  $\leq 20^\circ\text{C}$  internal temperature rise (general guide)

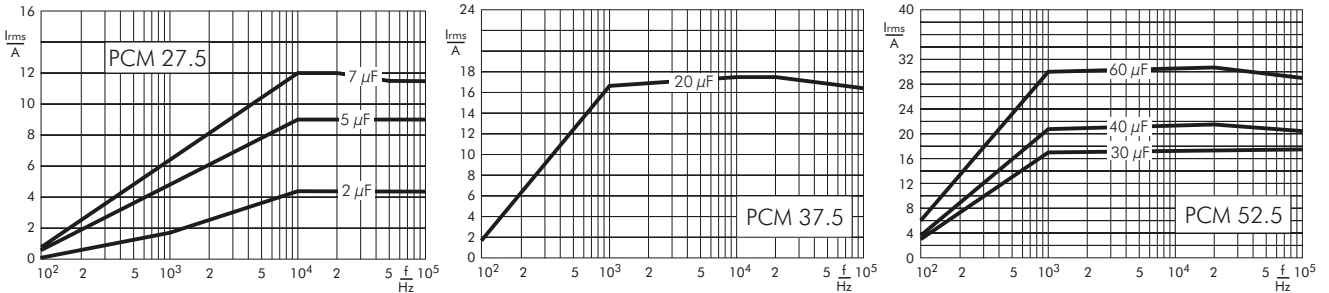

### 1300 VDC

Impedance change with frequency (general guide)

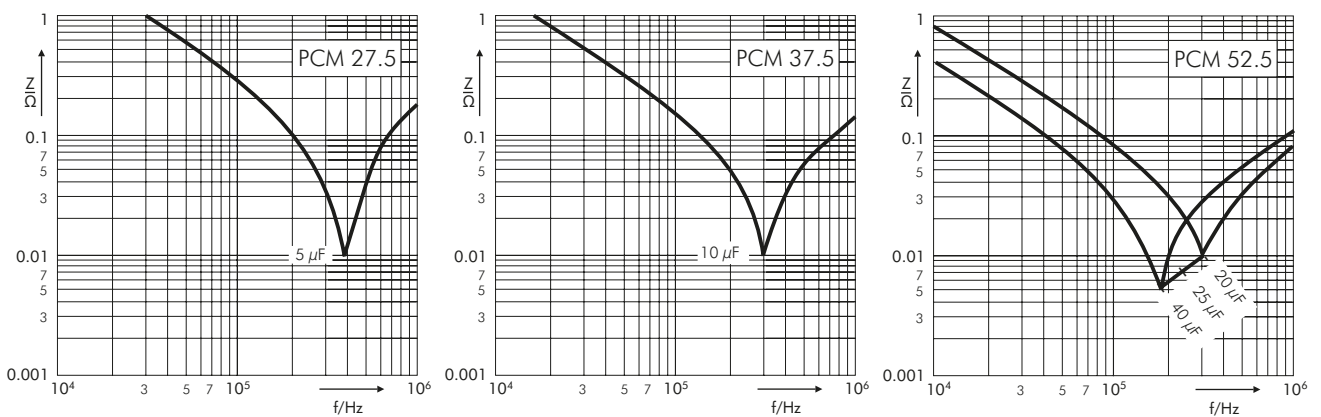

Permissible AC current in relation to frequency at  $\leq 20^\circ\text{C}$  internal temperature rise (general guide)

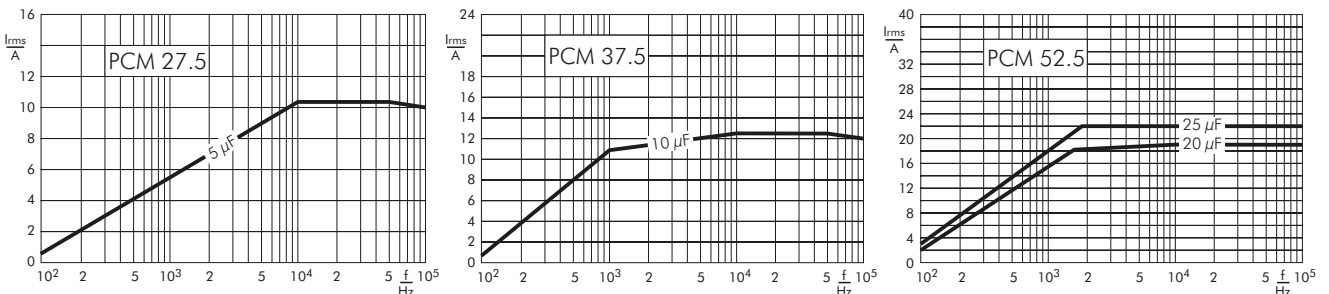

## Continuation

### Plate versions

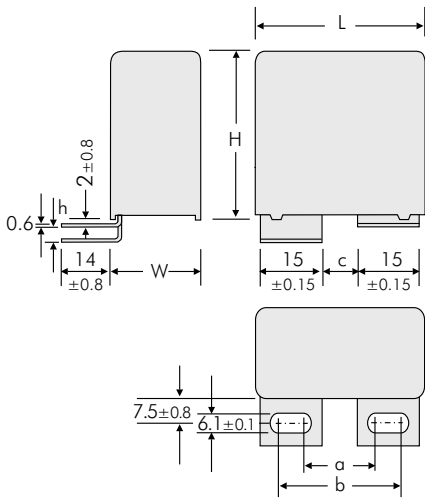

Version	L	a ±0.5	b ±0.5	c ±0.5	h ±0.8
<b>A1</b>	41.5	17.5	28	7.5	0
<b>A1.5</b>	41.5	17.5	28	7.5	3.5

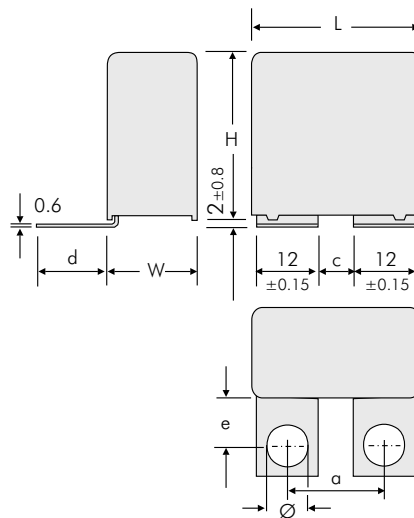

Version	L	a ±0.5	c ±0.5	d ±0.8	e ±0.8	Ø ±0.1
<b>A1.6</b>	41.5	18	6	21.5	16	7
<b>A1.6.1</b>	41.5	22	10	18.5	13	7
<b>A1.6.2</b>	41.5	23	10	18.5	13	8

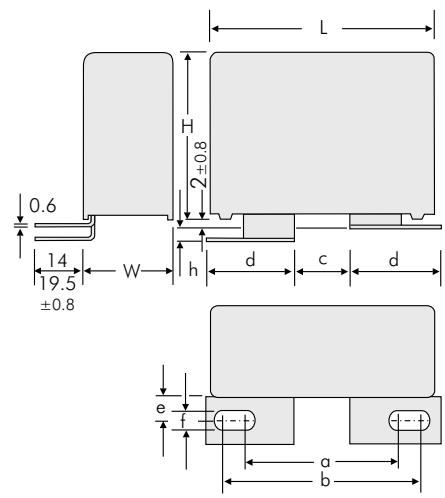

Version	L	a ±0.5	b ±0.5	c ±0.5	d ±0.15	e ±0.8	f ±0.1	h ±0.8
<b>A2</b>	41.5	36	46.5	14.5	22	7.5	8.4	0
<b>A2.4.1</b>	41.5	33.5	39.5	7.5	22	13	8.4	0
<b>A2.6.1</b>	41.5	31.5	41.5	14	22	13	6.1	3.5
<b>A2.6.2</b>	41.5	31.5	41.5	14	22	13	6.1	0
<b>A2.8</b>	41.5	36	46.5	14.5	22	7.5	8.4	3.5

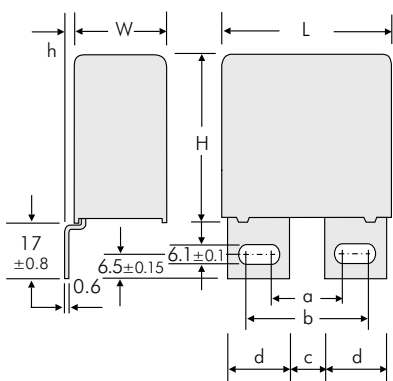

Version	L	a ±0.5	b ±0.5	c ±0.5	d ±0.15	h ±0.8
<b>A3</b>	41.5	17.5	27.5	7.5	15	0
<b>A3.5</b>	41.5	17.5	27.5	7.5	15	3
<b>A3.12</b>	41.5	17.5	30	7.5	16.5	0

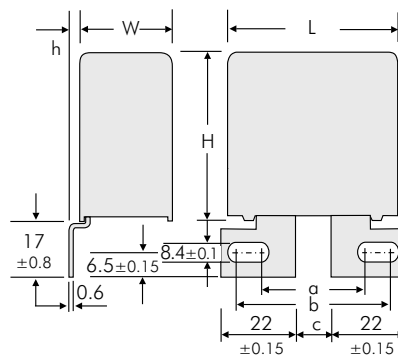

Version	L	a ±0.5	b ±0.5	c ±0.5	h ±0.8
<b>A3.9</b>	41.5	40.5	46.5	14.5	0
<b>A3.11</b>	41.5	40.5	46.5	14.5	3

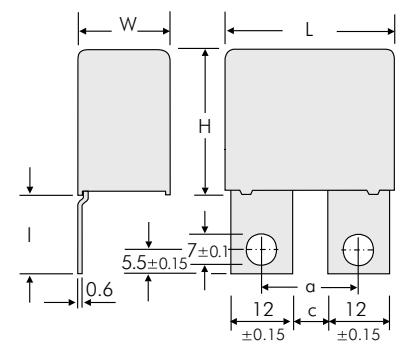

Version	L	a ±0.5	c ±0.5	l ±0.8
<b>A3.8</b>	41.5	18	6	23
<b>A3.8.1</b>	41.5	22	10	17.5
<b>A3.8.2</b>	41.5	22	10	23

## Continuation

### Plate versions

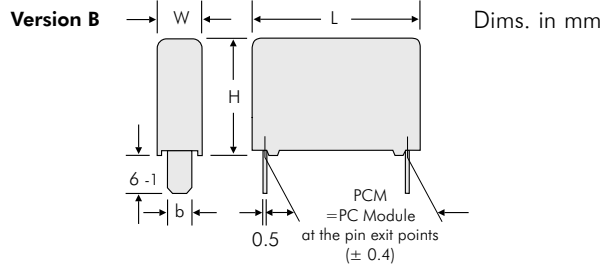
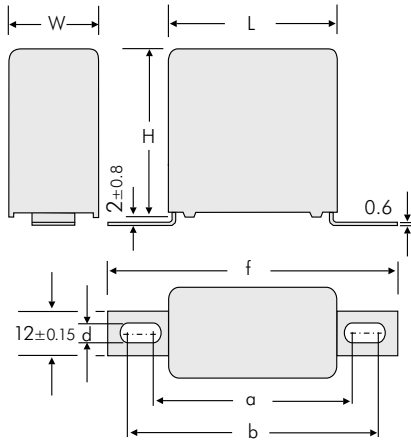

L	PCM	b ±0.15
31.5	28.5	8
41.5	38.5	8

Additional special versions can be realized. Please contact us with your specific needs.

Version	L	a ±0.8	b ±0.8	f ±0.8	d ±0.1
<b>A4.9</b>	31.5 W ≥ 15	44	47	57	4.5
<b>A4.10</b>	31.5 W ≥ 15	43	59	69	6.1
<b>A4.2</b>	41.5 W ≥ 15	54	57	67	4.5
<b>A4</b>	41.5 W ≥ 15	53	69	79	6.1

Possible connecting respective plate versions - depending on box size

Version code		D2	D4	B8	1A	1H	1I	1J	1S	2A	2F	2J	2K	2M	3A	3G	3K	3L	3M	3N	3P	3Q	4A	4C	4L	4M
W x H x L	Size Code	2-pin	4-pin	B8	A1	A1.5	A1.6	A1.6.1	A1.6.2	A2	A2.4.1	A2.6.1	A2.6.2	A2.8	A3	A3.5	A3.8	A3.8.1	A3.8.2	A3.9	A3.11	A3.12	A4	A4.2	A4.9	A4.10
9 x 19 x 31.5	<b>6A</b>																									
11 x 21 x 31.5	<b>6B</b>																									
13 x 24 x 31.5	<b>6D</b>																									
15 x 26 x 31.5	<b>6F</b>																									
17 x 29 x 31.5	<b>6G</b>																									
17 x 34.5 x 31.5	<b>6I</b>																									
20 x 39.5 x 31.5	<b>6J</b>																									
13 x 24 x 41.5	<b>7C</b>																									
15 x 26 x 41.5	<b>7D</b>																									
17 x 29 x 41.5	<b>7E</b>																									
19 x 32 x 41.5	<b>7F</b>																									
20 x 39.5 x 41.5	<b>7G</b>																									
24 x 45.5 x 41.5	<b>7H</b>																									
28 x 38 x 41.5	<b>7L</b>																									
31 x 46 x 41.5	<b>7I</b>																									
35 x 50 x 41.5	<b>7J</b>																									
40 x 55 x 41.5	<b>7K</b>																									

## Recommendation for Processing and Application of Through-Hole Capacitors

### Soldering Process

Internal temperature of the capacitor must be kept as follows:

Polyester: preheating:  $T_{max.} \leq 125^{\circ}C$   
soldering:  $T_{max.} \leq 135^{\circ}C$

Polypropylene: preheating:  $T_{max.} \leq 100^{\circ}C$   
soldering:  $T_{max.} \leq 110^{\circ}C$

#### Single wave soldering

Soldering bath temperature:  $T < 260^{\circ}C$   
Dwell time:  $t < 5 \text{ sec}$

#### Double wave soldering

Soldering bath temperature:  $T < 260^{\circ}C$   
Dwell time:  $\sum t < 5 \text{ sec}$

Due to different soldering processes and heat requirements the graphs are to be regarded as a recommendation only.

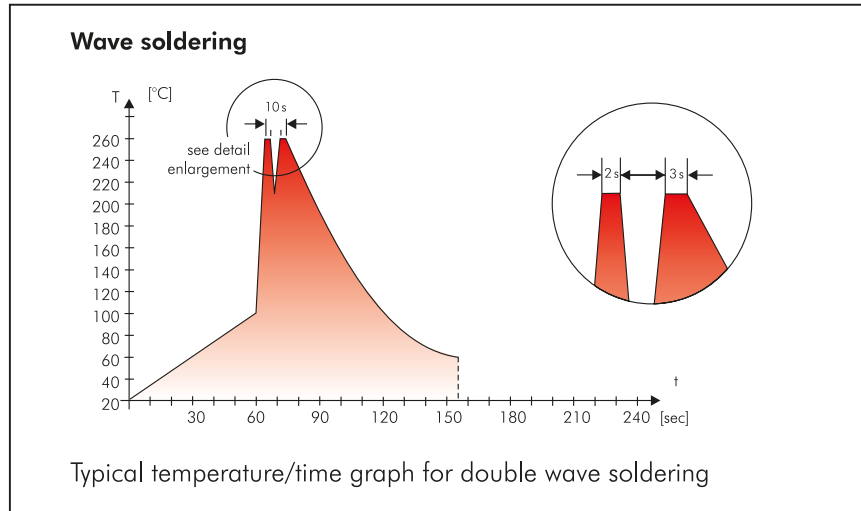

## WIMA Quality and Environmental Philosophy

### ISO 9001:2015 Certification

ISO 9001:2015 is an international basic standard of quality assurance systems for all branches of industry. The approval according to ISO 9001:2015 of our factories certifies that organisation, equipment and monitoring of quality assurance in our factories correspond to internationally recognized standards.

### WIMA WPCS

The WIMA Process Control System (WPCS) is a quality surveillance and optimization system developed by WIMA. WPCS is a major part of the quality-oriented WIMA production. Points of application during production process:

- incoming material inspection
- metallization
- film inspection
- schoopage
- pre-healing
- pin attachment
- cast resin preparation/encapsulation
- 100% final inspection
- Testing as per customer requirements

### WIMA Environmental Policy

All WIMA capacitors, irrespective of whether through-hole devices or SMD, are made of environmentally friendly materials. Neither during manufacture nor in the product itself any toxic substances are used, e.g.

- Lead
- PCB
- CFC
- Hydrocarbon chloride
- Chromium 6+
- PBB/PBDE
- Arsenic
- Cadmium
- Mercury
- etc.

We merely use pure, recyclable materials for packing our components, such as:

- carton
- cardboard
- adhesive tape made of paper
- polystyrene

We almost completely refrain from using packing materials such as:

- adhesive tapes made of plastic
- metal clips

### RoHS Compliance

According to the RoHS Directive 2015/863/EU as amended from time to time certain hazardous substances like e.g. lead, cadmium, mercury must not be used any longer in electronic equipment as of July 1st, 2006. For the sake of the environment WIMA has re-frained from using such substances since years already.



WIMA Kondensatoren sind bleifrei konform RoHS 2015/863/EU

WIMA capacitors are lead free in accordance with RoHS 2015/863/EU

Tape for lead-free WIMA capacitors

### DIN EN ISO 14001:2004

WIMA's environmental management has been established in accordance with the guidelines of DIN EN ISO 14001:2004 to optimize the production processes with regard to energy and resources.

# Typical Dimensions for Taping Configuration

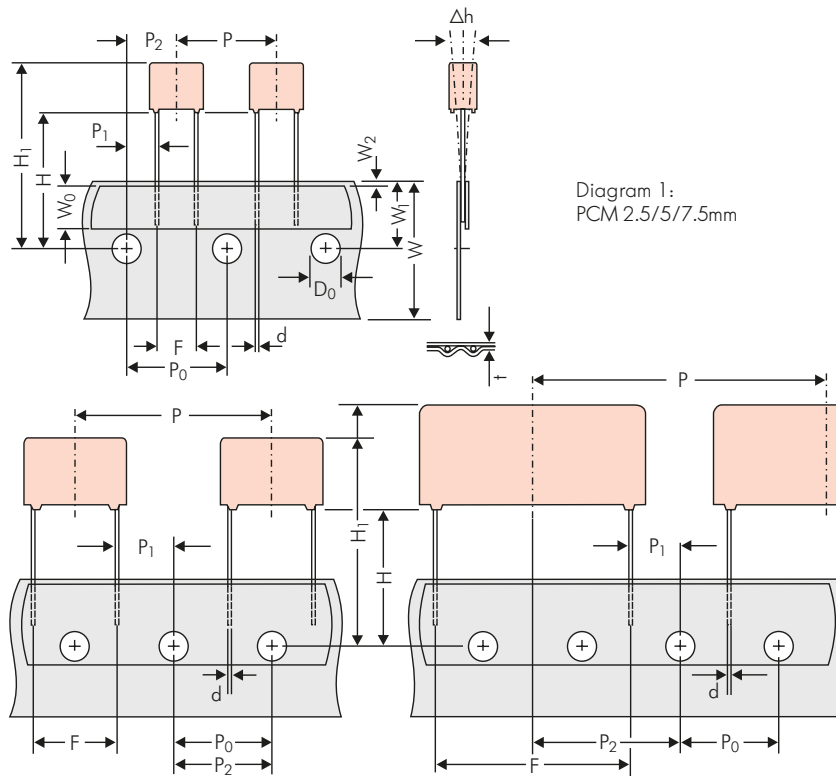

Diagram 1:  
PCM 2.5/5/7.5mm

Diagram 2: PCM 10/15 mm

Diagram 3: PCM 22.5 and 27.5\*mm

\*PCM 27.5 tapping possible with two feed holes between components

Designation	Symbol	Dimensions for Radial Taping							
		PCM 2.5 tapping	PCM 5 tapping	PCM 7.5 tapping	PCM 10 tapping*	PCM 15 tapping*	PCM 22.5 tapping	PCM 27.5 tapping	
Carrier tape width	W	18.0 ±0.5	18.0 ±0.5	18.0 ±0.5	18.0 ±0.5	18.0 ±0.5	18.0 ±0.5	18.0 ±0.5	
Hold-down tape width	W <sub>0</sub>	6.0 for hot-sealing adhesive tape	6.0 for hot-sealing adhesive tape	12.0 for hot-sealing adhesive tape	12.0 for hot-sealing adhesive tape	12.0 for hot-sealing adhesive tape	12.0 for hot-sealing adhesive tape	12.0 for hot-sealing adhesive tape	
Hole position	W <sub>1</sub>	9.0 ±0.5	9.0 ±0.5	9.0 ±0.5	9.0 ±0.5	9.0 ±0.5	9.0 ±0.5	9.0 ±0.5	
Hold-down tape position	W <sub>2</sub>	0.5 to 3.0 max.	0.5 to 3.0 max.	0.5 to 3.0 max.	0.5 to 3.0 max.	0.5 to 3.0 max.	0.5 to 3.0 max.	0.5 to 3.0 max.	
Feed hole diameter	D <sub>0</sub>	4.0 ±0.2	4.0 ±0.2	4.0 ±0.2	4.0 ±0.2	4.0 ±0.2	4.0 ±0.2	4.0 ±0.2	
Pitch of component	P	12.7 ±1.0	12.7 ±1.0	12.7 ±1.0	25.4 ±1.0	25.4 ±1.0	38.1 ±1.5	*38.1 ±1.5 or 50.8 ±1.5	
Feed hole pitch	P <sub>0</sub>	12.7 ±0.3 error max. 1.0 mm/20 pitch	12.7 ±0.3 error max. 1.0 mm/20 pitch	12.7 ±0.3 error max. 1.0 mm/20 pitch	12.7 ±0.3 error max. 1.0 mm/20 pitch	12.7 ±0.3 error max. 1.0 mm/20 pitch	12.7 ±0.3 error max. 1.0 mm/20 pitch	12.7 ±0.3 error max. 1.0 mm/20 pitch	
Feed hole centre to pin	P <sub>1</sub>	5.1 ±0.5	3.85 ±0.7	2.6 ±0.7	7.7 ±0.7	5.2 ±0.7	7.8 ±0.7	5.3 ±0.7	
Hole centre to component centre	P <sub>2</sub>	6.35 ±1.3	6.35 ±1.3	6.35 ±1.3	12.7 ±1.3	12.7 ±1.3	19.05 ±1.3	19.05 ±1.3	
Feed hole centre to bottom edge of the component	H <sub>▲</sub>	16.5 ±0.3 18.5 ±0.5	16.5 ±0.3 18.5 ±0.5	16.5 ±0.5 18.5 ±0.5	16.5 ±0.5 18.5 ±0.5	16.5 ±0.5 18.5 ±0.5	16.5 ±0.5 18.5 ±0.5	16.5 ±0.5 18.5 ±0.5	
Feed hole centre to top edge of the component	H <sub>1</sub>	H+H <sub>component</sub> < H <sub>1</sub> 32.25 max.	H+H <sub>component</sub> < H <sub>1</sub> 32.25 max.	H+H <sub>component</sub> < H <sub>1</sub> 24.5 to 31.5	H+H <sub>component</sub> < H <sub>1</sub> 25.0 to 31.5	H+H <sub>component</sub> < H <sub>1</sub> 26.0 to 37.0	H+H <sub>component</sub> < H <sub>1</sub> 30.0 to 43.0	H+H <sub>component</sub> < H <sub>1</sub> 35.0 to 45.0	
Pin spacing at upper edge of carrier tape	F	2.5 ±0.5	5.0 <sup>+0.8</sup> <sub>-0.2</sub>	7.5 ±0.8	10.0 ±0.8	15 ±0.8	22.5 ±0.8	27.5 ±0.8	
Pin diameter	d	0.4 ±0.05	0.5 ±0.05	*0.5 ±0.05 or 0.6 <sup>+0.06</sup> <sub>-0.05</sub>	*0.5 ±0.05 or 0.6 <sup>+0.06</sup> <sub>-0.05</sub>	0.8 <sup>+0.08</sup> <sub>-0.05</sub>	0.8 <sup>+0.08</sup> <sub>-0.05</sub>	0.8 <sup>+0.08</sup> <sub>-0.05</sub>	
Component alignment	Δh	± 2.0 max.	± 2.0 max.	± 3.0 max.	± 3.0 max.	± 3.0 max.	± 3.0 max.	± 3.0 max.	
Total tape thickness	t	0.6 ±0.2	0.6 ±0.2	0.6 ±0.2	0.6 ±0.2	0.6 ±0.2	0.6 ±0.2	0.6 ±0.2	
Package (see also page 158)	▲	ROLL/AMMO			AMMO				
		REEL Ø 360 max. Ø 30 ±1	B 52 ±2 58 ±2	depending on comp. dimensions	REEL Ø 360 max. Ø 30 ±1	B 52 ±2 58 ±2 66 ±2	or REEL Ø 500 max. Ø 25 ±1	B 54 ±2 60 ±2 68 ±2	depending on PCM and component dimensions
Unit		see details page 159.							

▲ When ordering please specify dimension H and required packaging type.

Dims in mm.

• Diameter of pins see General Data.

Please clarify customer-specific deviations with the manufacturer.

\* PCM 10 and PCM 15 can be crimped to PCM 7.5.

Position of components according to PCM 7.5 (sketch 1). P<sub>0</sub> = 12.7 or 15.0 is possible

## Types of Tape Packaging of Capacitors for Automatic Radial Insertion

### ■ ROLL Packaging

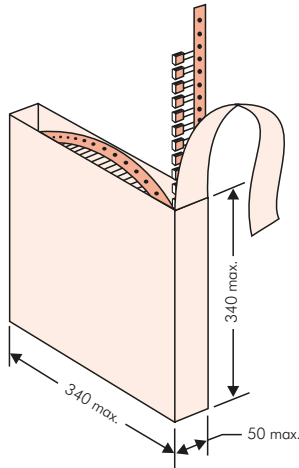

### ■ AMMO Packaging

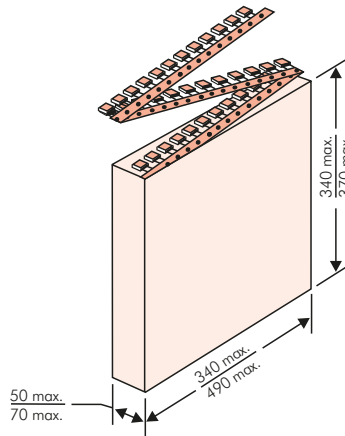

### ■ REEL Packaging

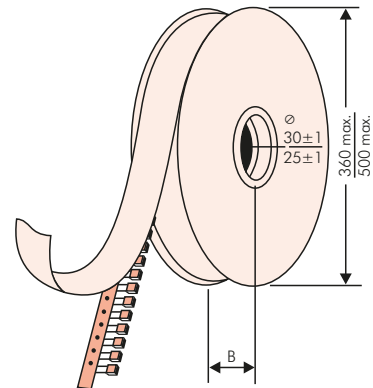

## BAR CODE (Labelling)

Labelling of package units in plain text and with alphanumeric Bar Code

- WIMA supplier number
- Date code
- Customer's P/O number
- P/O line
- Customer's part number
- WIMA part number
- Quantity
- WIMA confirmation number
- Country of origin
- Customer name
- Handling unit number
- Week of delivery.

In addition part description of

- article
- capacitance value
- rated voltage
- dimensions
- technical note
- capacitance tolerance
- packing
- connecting information

BARCODE PDF417  
BARCODE 2D Datamatrix

**WIMA** Best Capacitors Made in Germany  
Werk Aurich

Supplier-ID: LIEF.NR.	Date Code: 20210419
Purchase Order No. (P/O): Bestellung xyz	P/O line: 100
Customer Part No.: KUNDENTEILENUMMER	
WIMA Part No.: MKP1F041006B00KSSD	Quantity: 459
WIMA Confirmation No.: 0001105072000100	RoHS 2011/65/EU
	COO: DE
Customer No.: 0000100002	
Gross Weight [g]: 4557	
<b>WIMA – MKP 10</b>	WIMA Part No.: MKP1F041006B00KSSD
MKP 10 1.0 µF 250 VDC 11x21x31.5 RM27.5	
Standard 10% Lose – Standard Drähte 6–2	
Vorlage Debitor Inland	
	0001105072000100
1002021443	QTY: 459 Week 19/2021



## Packing Quantities for Capacitors with Radial Pins in PCM 2.5 mm to 27.5 mm

PCM	Size				bulk	pcs. per packing unit											
						ROLL		REEL				AMMO					
	W	H	L	Codes		S	N	O	Ø 360		Ø 500		340 x 340		490 x 370		
								H16.5	H18.5	H16.5	H18.5	H16.5	H18.5	H16.5	H18.5	H16.5	H18.5
<b>2.5 mm</b>	2.5	7	4.6	<b>0B</b>	5000			2200			2500			2800			
	3	7.5	4.6	<b>0C</b>	5000			2000			2300			2300			
	3.8	8.5	4.6	<b>0D</b>	5000			1500			1800			1800			
	4.6	9	4.6	<b>0E</b>	5000			1200			1500			1500			
	5.5	10	4.6	<b>0F</b>	5000			900			1200			1200			
<b>5 mm</b>	2.5	6.5	7.2	<b>1A</b>	5000			2200			2500			2800			
	3	7.5	7.2	<b>1B</b>	5000			2000			2300			2300			
	3.5	8.5	7.2	<b>1C</b>	5000			1600			2000			2000			
	4.5	6	7.2	<b>1D</b>	6000			1300			1500			1500			
	4.5	9.5	7.2	<b>1E</b>	4000			1300			1500			1500			
	5	10	7.2	<b>1F</b>	3500			1100			1400			1400			
	5.5	7	7.2	<b>1G</b>	4000			1000			1200			1200			
	5.5	11.5	7.2	<b>1H</b>	2500			1000			1200			1200			
	6.5	8	7.2	<b>1I</b>	2500			800			1000			1000			
	7.2	8.5	7.2	<b>1J</b>	2500			700			1000			1000			
	7.2	13	7.2	<b>1K</b>	2000			700			950			1000			
	8.5	10	7.2	<b>1L</b>	2000			600			800			800			
	8.5	14	7.2	<b>1M</b>	1500			600			800			800			
11	16	7.2	<b>1N</b>	1000			500			600			640				
<b>7.5 mm</b>	2.5	7	10	<b>2A</b>	5000					2500		4400	2500				
	3	8.5	10	<b>2B</b>	5000					2200		4300	2300		4150		
	4	9	10	<b>2C</b>	4000					1700		3200	1700		3000		
	4.5	9.5	10.3	<b>2D</b>	3500					1500		2900	1400		2700		
	5	10.5	10.3	<b>2E</b>	3000					1300		2500	1300				
	5.7	12.5	10.3	<b>2F</b>	2000					1000		2200	1100				
	7.2	12.5	10.3	<b>2G</b>	1500					900		1800	1000				
<b>10 mm</b>	3	9	13	<b>3A</b>	3000					1100		2200			1900		
	4	9	13	<b>3C</b>	3000					900		1600			1450		
	4	9.5	13	<b>3D</b>	3000					900		1600			1400		
	5	11	13	<b>3F</b>	3000					700		1300			1100		
	6	12	13	<b>3G</b>	2400						550		1100			1000	
	6	12.5	13	<b>3H</b>	2400						550		1100			1000	
	8	12	13	<b>3I</b>	2000						400		800			740	
<b>15 mm</b>	5	11	18	<b>4B</b>	2400					600		1200			1150		
	6	12.5	18	<b>4C</b>	2000					500		1000			1000		
	7	14	18	<b>4D</b>	1600					450		900			850		
	8	15	18	<b>4F</b>	1200					400		800			740		
	9	14	18	<b>4H</b>	1200					350		700			650		
	9	16	18	<b>4J</b>	900					350		700			650		
	11	14	18	<b>4M</b>	1000					300		600			540		
<b>22.5 mm</b>	5	14	26.5	<b>5A</b>	1200							800			770		
	6	15	26.5	<b>5B</b>	1000							700			640		
	7	16.5	26.5	<b>5D</b>	760							600			550		
	8.5	18.5	26.5	<b>5F</b>	500							480			450		
	10.5	19	26.5	<b>5G</b>	594*							400			360		
	10.5	20.5	26.5	<b>5H</b>	594*							400			360		
11	21	26.5	<b>5I</b>	561*							380			350			
<b>27.5 mm</b>	9	19	31.5	<b>6A</b>	567*							460/340*					
	11	21	31.5	<b>6B</b>	459*							380/280*					
	13	24	31.5	<b>6D</b>	378*							300					
	15	26	31.5	<b>6F</b>	324*							270					
	17	29	31.5	<b>6G</b>	198*												
	17	34.5	31.5	<b>6I</b>	198*												
	20	39.5	31.5	<b>6J</b>	162*												

\* for 2-inch transport pitches.

\* TPS (Tray-Packing-System). Plate versions may have different packing units. Samples and pre-production needs on request.

Rights reserved to amend design data without prior notification.



## Packing Quantities for Capacitors with Radial Pins in PCM 37.5 mm to 52.5 mm

PCM	Size				bulk	pcs. per packing unit									
						ROLL		REEL				AMMO			
	W	H	L	Codes		S	N	O	Ø 360		Ø 500		340 x 340		490 x 370
								F	I	H	J	A	C	B	D
<b>37.5 mm**</b>	9	19	41.5	<b>7A</b>	441*	-	-	-	-	-	-	-	-	-	-
	11	22	41.5	<b>7B</b>	357*	-	-	-	-	-	-	-	-	-	-
	13	24	41.5	<b>7C</b>	294*	-	-	-	-	-	-	-	-	-	-
	15	26	41.5	<b>7D</b>	252*	-	-	-	-	-	-	-	-	-	-
	17	29	41.5	<b>7E</b>	154*	-	-	-	-	-	-	-	-	-	-
	19	32	41.5	<b>7F</b>	140*	-	-	-	-	-	-	-	-	-	-
	20	39.5	41.5	<b>7G</b>	126*	-	-	-	-	-	-	-	-	-	-
	24	45.5	41.5	<b>7H</b>	112*	-	-	-	-	-	-	-	-	-	-
	28	38	41.5	<b>7L</b>	84*	-	-	-	-	-	-	-	-	-	-
	31	46	41.5	<b>7I</b>	84*	-	-	-	-	-	-	-	-	-	-
	35	50	41.5	<b>7J</b>	35*	-	-	-	-	-	-	-	-	-	-
	40	55	41.5	<b>7K</b>	28*	-	-	-	-	-	-	-	-	-	-
<b>48.5 mm**</b>	19	31	56	<b>8D</b>	120*	-	-	-	-	-	-	-	-	-	
	23	34	56	<b>8E</b>	80*	-	-	-	-	-	-	-	-	-	
	27	37.5	56	<b>8H</b>	84*	-	-	-	-	-	-	-	-	-	
	33	48	56	<b>8J</b>	25*	-	-	-	-	-	-	-	-	-	
	37	54	56	<b>8L</b>	25*	-	-	-	-	-	-	-	-	-	
<b>52.5 mm</b>	25	45	57	<b>9D</b>	70*	-	-	-	-	-	-	-	-	-	
	30	45	57	<b>9E</b>	60*	-	-	-	-	-	-	-	-	-	
	35	50	57	<b>9F</b>	25*	-	-	-	-	-	-	-	-	-	
	45	55	57	<b>9H</b>	20*	-	-	-	-	-	-	-	-	-	
	45	65	57	<b>9J</b>	20*	-	-	-	-	-	-	-	-	-	

\* TPS (Tray-Packing-System). Plate versions may have different packing units.

\*\*For Snubber capacitors in 2-pin version the PCM is changing to 38.5 respective 49.5 mm. Samples and pre-production needs on request.

Rights reserved to amend design data without prior notification.

Updated data on [www.wima.com](http://www.wima.com)



A WIMA part number consists of 18 digits and is composed as follows:

- Field 1 - 4: Type description
- Field 5 - 6: Rated voltage
- Field 7 - 10: Capacitance
- Field 11 - 12: Size and PCM
- Field 13 - 14: Version code (e.g. Snubber versions)
- Field 15: Capacitance tolerance
- Field 16: Packing
- Field 17 - 18: Pin length (untaped)

1	2	3	4	5	6	7	8	9	10	11	12	13	14	15	16	17	18
M	K	S	2	C	0	2	1	0	0	1	A	0	0	M	S	S	D
MKS 2				63 VDC		0.01 µF			2.5x6.5x7.2		-		20%	bulk	6 -2		

<p><b>Type description:</b></p> <p>SMD-PET = SMDT              SMD-PEN = SMDN              SMD-PPS = SMDI              FKP 02 = FKPO              MKS 02 = MKS0              FKS 2 = FKS2              FKP 2 = FKP2              FKS 3 = FKS3              FKP 3 = FKP 3              MKS 2 = MKS2              MKP 2 = MKP2              MKS 4 = MKS4              MKP 4 = MKP4              MKP 10 = MKP1              FKP 4 = FKP4              FKP 1 = FKP1              MKP-X2 = MKX2              MKP-X1 R = MKX1              MKP-Y2 = MKY2              MKP 4F = MKPF              Snubber MKP = SNMP              Snubber FKP = SNFP              GTO MKP = GTOM              DC-LINK MKP 4 = DCP4              DC-LINK MKP 6 = DCP6              DC-LINK HC = DCHC</p>	<p><b>Rated voltage:</b></p> <p>50 VDC = B0              63 VDC = C0              100 VDC = D0              250 VDC = F0              400 VDC = G0              450 VDC = H0              520 VDC = H2              600 VDC = I0              630 VDC = J0              700 VDC = K0              800 VDC = L0              850 VDC = M0              900 VDC = N0              1000 VDC = O1              1100 VDC = P0              1200 VDC = Q0              1250 VDC = R0              1500 VDC = S0              1600 VDC = T0              1700 VDC = TA              2000 VDC = U0              2500 VDC = V0              3000 VDC = W0              4000 VDC = X0              6000 VDC = Y0              230 VAC = 3Y              275 VAC = 1W              300 VAC = 2W              305 VAC = AW              350 VAC = BW              440 VAC = 4W              ...</p>	<p><b>Capacitance:</b></p> <p>22 pF = 0022              47 pF = 0047              100 pF = 0100              150 pF = 0150              220 pF = 0220              330 pF = 0330              470 pF = 0470              680 pF = 0680              1000 pF = 1100              1500 pF = 1150              2200 pF = 1220              3300 pF = 1330              4700 pF = 1470              6800 pF = 1680              0.01 µF = 2100              0.022 µF = 2220              0.047 µF = 2470              0.1 µF = 3100              0.22 µF = 3220              0.47 µF = 3470              1 µF = 4100              2.2 µF = 4220              4.7 µF = 4470              10 µF = 5100              22 µF = 5220              47 µF = 5470              100 µF = 6100              220 µF = 6220              1000 µF = 7100              1500 µF = 7150              ...</p>	<p><b>Size:</b></p> <p>4.8x3.3x3 Size 1812 = KA              4.8x3.3x4 Size 1812 = KB              5.7x5.1x3.5 Size 2220 = QA              5.7x5.1x4.5 Size 2220 = QB              7.2x6.1x3 Size 2824 = TA              7.2x6.1x5 Size 2824 = TB              10.2x7.6x5 Size 4030 = VA              12.7x10.2x6 Size 5040 = YA              15.3x13.7x7 Size 6054 = YA              2.5x7x4.6 PCM2.5 = 0B              3x7.5x4.6 PCM2.5 = 0C              2.5x6.5x7.2 PCM5 = 1A              3x7.5x7.2 PCM5 = 1B              2.5x7x10 PCM7.5 = 2A              3x8.5x10 PCM7.5 = 2B              3x9x13 PCM10 = 3A              4x9x13 PCM10 = 3C              5x11x18 PCM15 = 4B              6x12.5x18 PCM15 = 4C              5x14x26.5 PCM22.5 = 5A              6x15x26.5 PCM22.5 = 5B              9x19x31.5 PCM27.5 = 6A              11x21x31.5 PCM27.5 = 6B              9x19x41.5 PCM37.5 = 7A              11x22x41.5 PCM37.5 = 7B              19x31x56 PCM 48.5 = 8D              25x45x57 PCM 52.5 = 9D              ...</p>	<p><b>Tolerance:</b></p> <p>±20% = M              ±10% = K              ±5% = J              ±2.5% = H              ±1% = E              ...</p> <p><b>Packing:</b></p> <p>AMMO H16.5 340x340 = A              AMMO H16.5 490x370 = B              AMMO H18.5 340x340 = C              AMMO H18.5 490x370 = D              REEL H16.5 360 = F              REEL H16.5 500 = H              REEL H18.5 360 = I              REEL H18.5 500 = J              ROLL H16.5 = N              ROLL H18.5 = O              BLISTER W12 180 = P              BLISTER W12 330 = Q              BLISTER W16 330 = R              BLISTER W24 330 = T              Bulk/TPS Standard = S              ...</p>
			<p><b>Version code:</b></p> <p>Standard = 00              Version A1 = 1A              Version A1.1.1 = 1B              Version A2 = 2A              ...</p>	<p><b>Pin length (untaped)</b></p> <p>3.5 ±0.5 = C9              6 -2 = SD              16 ±1 = P1              ...</p> <p><b>Pin length (taped)</b></p> <p>none = 00</p>

The data on this page is not complete and serves only to explain the part number system. Part number information is listed on the pages of the respective WIMA range.

## Looking for pricing, stock, or lifecycle information?

Click below to explore more details on WIN SOURCE:

-  [View DCP4L054007ID4MSSD on WIN SOURCE](#)
-  [WIMA Information](#)

## Optimize Your Supply Chain with WIN SOURCE Solutions

-  Global Sourcing Solution
-  Obsolete Management
-  Cost Control Management
-  Shortage Management
-  Alternative Solution
-  Excess Inventory Management