



**THE DATASHEET OF
C4AQLBU4560A1WK**



C4AQ, Radial, 2 or 4 Leads, 500 - 1,500 VDC, for DC Link (Automotive Grade)

Overview

The C4AQ capacitor is a polypropylene metallized film capacitor with a rectangular, plastic box-type design (white or grey in color) filled with resin, and uses 2 or 4 tinned wires.

Automotive grade devices meet the demanding Automotive Electronics Council's AEC-Q200 qualification requirements.

Applications

Typical applications include DC filtering, DC link, power electronics, energy storage, renewable energy grid interface, motor drives, and automotive applications.

Benefits

- Self-healing
- Low loss
- Low ESL
- Low profile dimensions available
- High ripple current
- High capacitance density
- High contact reliability
- Suitable for high frequency applications
- Automotive Grades (AEC-Q200)

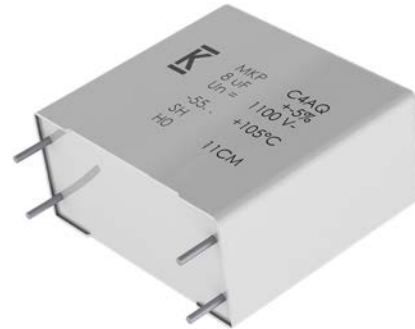

Part Number System

C4	A	Q	U	B	W	5270	A	3	N	J
Series	Type	Application	Rated Voltage (VDC)	Case	Terminals Code	Capacitance Code (pF)	Release	Lead Diameter (mm)	Size Code	Tolerance
C4 = MKP Power Capacitors	A = Box, wire terminals	Q = DC Link Automotive Grade	L = 500 C = 650 I = 800 Q = 1,100 U = 1,300 S = 1,500	B, E = Box plastic case L = Low Profile box plastic case	U = 2 pins W = 4 pins	Digits two – four indicate the first three digits of the capacitance value. First digit indicates the number of zeros to be added.	A = Standard B – Z = Special	1 = 0.8 2 = 1.0 3 = 1.2	See dimensions table below for valid case sizes	J = 5% K = 10%

Dimensions – Millimeters

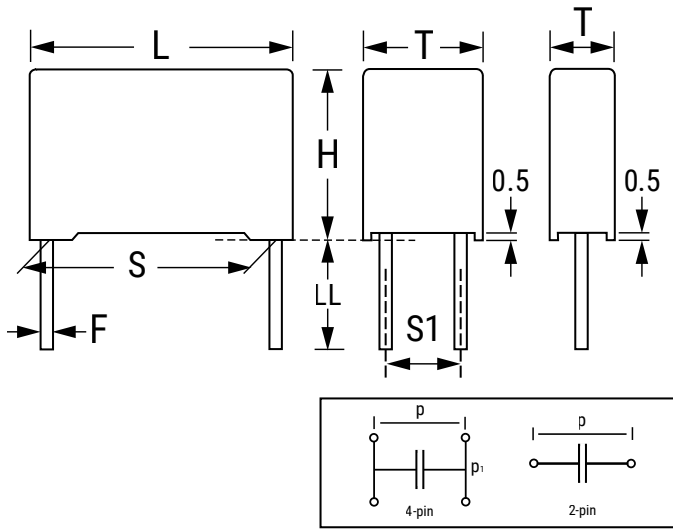

Size Code		S		S1		T		H		L		LL		F	
Digit 6	Digit 14	Nominal	Tolerance	Nominal	Tolerance	Nominal	Tolerance	Nominal	Tolerance	Nominal	Tolerance	Nominal	Tolerance	Nominal	Tolerance
B	W	27.5	±0.4	-	-	11.0	+0.3/-0.7	20.0	+0.2/-0.7	31.5	+0.5/-0.7	6	+0/-2	0.8	±0.05
B	X	27.5	±0.4	-	-	13.0	+0.3/-0.7	25.0	+0.2/-0.7	31.5	+0.5/-0.7	6	+0/-2	0.8	±0.05
B	Y	27.5	±0.4	-	-	14.0	+0.3/-0.7	28.0	+0.2/-0.7	31.5	+0.5/-0.7	6	+0/-2	0.8	±0.05
B	1	27.5	±0.4	-	-	19.0	+0.3/-0.7	29.0	+0.2/-0.7	31.5	+0.5/-0.7	6	+0/-2	0.8	±0.05
B	2	27.5	±0.4	-	-	22.0	+0.3/-0.7	37.0	+0.2/-0.7	31.5	+0.5/-0.7	6	+0/-2	0.8	±0.05
B	F	37.5	±0.4	5.1/10.2	±0.4	20.0	+0.4/-0.7	40.0	+0.2/-0.7	42.0	+0.6/-0.7	6	+0/-2	1.2	±0.05
B	J	37.5	±0.4	10.2	±0.4	28.0	+0.4/-0.7	37.0	+0.2/-0.7	42.0	+0.6/-0.7	6	+0/-2	1.2	±0.05
B	L	37.5	±0.4	20.3	±0.4	30.0	+0.4/-0.7	45.0	+0.2/-0.7	42.0	+0.6/-0.7	6	+0/-2	1.2	±0.05
B	O	37.5	±0.4	20.3	±0.4	35.0	+0.4/-0.7	50.0	+0.2/-0.7	42.0	+0.6/-0.7	6	+0/-2	1.2	±0.05
B	M	52.5	±0.4	20.3	±0.4	30.0	+0.5/-0.7	45.0	+0.3/-0.7	57.5	+0.8/-0.7	6	+0/-2	1.2	±0.05
B	N	52.5	±0.4	20.3	±0.4	35.0	+0.5/-0.7	50.0	+0.3/-0.7	57.5	+0.8/-0.7	6	+0/-2	1.2	±0.05
E	A	52.5	±0.4	20.3	±0.4	45.0	+0.5/-0.7	56.0	+0.3/-0.7	57.5	+0.8/-0.7	6	+0/-2	1.2	±0.05
E	B	52.5	±0.4	20.3	±0.4	45.0	+0.5/-0.7	65.0	+0.3/-0.7	57.5	+0.8/-0.7	6	+0/-2	1.2	±0.05
L	1	27.7	±0.4	-	-	21.0	+0.3/-0.7	12.5	+0.2/-0.7	32.0	+0.5/-0.7	6	+0/-2	0.8	±0.05
L	2	27.5	±0.4	-	-	24.0	+0.3/-0.7	15.0	+0.2/-0.7	32.0	+0.5/-0.7	6	+0/-2	0.8	±0.05
L	3	37.5	±0.4	10.2	±0.4	24.0	+0.4/-0.7	19.0	+0.2/-0.7	41.5	+0.6/-0.7	6	+0/-2	1.2	±0.05
L	4	37.5	±0.4	10.2	±0.4	24.0	+0.4/-0.7	15.0	+0.2/-0.7	41.5	+0.6/-0.7	6	+0/-2	1.2	±0.05
L	6	37.5	±0.4	20.3	±0.4	35.0	+0.4/-0.7	24.0	+0.2/-0.7	42.0	+0.6/-0.7	6	+0/-2	1.2	±0.05
L	8	37.5	±0.4	20.3	±0.4	43.0	+0.4/-0.7	25.0	+0.2/-0.7	42.0	+0.6/-0.7	6	+0/-2	1.2	±0.05
L	9	27.5	±0.4	-	-	31.0	+0.3/-0.7	19.0	+0.2/-0.7	32.0	+0.5/-0.7	6	+0/-2	0.8	±0.05

Qualification

Reference Standards	IEC 61071, EN 61071, VDE0560
Climatic Category	55/105/56 according to IEC 60068-1

Automotive grade products meet or exceed the requirements outlined by the Automotive Electronics Council. Details regarding test methods and conditions are referenced in document AEC-Q200, Stress Test Qualification for Passive Components. For additional information regarding the Automotive Electronics Council and AEC-Q200, visit the AEC website at www.aecouncil.com.

General Technical Data

Dielectric	Polypropylene metallized film, non-inductive type, self-healing property
Application	DC filtering, DC link
Special Features	AEC-Q200 qualified
Climatic Category	55/105/56 IEC 60068-1
Temperature Range	-55°C to +105°C
Endurance Test	500 hours + 500 hours at $1.3 \times V_{NDC}$ at 70°C
	500 hours + 500 hours at $1.3 \times V_{OP85}$ at 85°C
	500 hours + 500 hours at $1.3 \times V_{OP105}$ at 105°C
Standard	IEC 61071, EN 61071, VDE0560, AEC-Q200
Protection	Solvent resistant plastic case UL 94 V-0 compliant Thermosetting resin sealing UL 94 V-0 compliant
Installation	Any position
Leads	Tinned copper wires - standard lead wire length 6 (+0/-2) mm
Packaging	Packed in cardboard trays with protection for the terminals
RoHS Compliance	Compliant with Directive 2002/95/EC and Directive 2011/65/EU of the European Parliament and the Council of the EU on 8 June 2011, including the Commission Delegated Directive (EU) 2015/863 that amended Annex II to Directive 2011/65/EU.

Electrical Characteristics

Rated Capacitance Range	1 to 210 μ F
Rated Voltage (V_{NDC}) Range	500 to 1,500 VDC
Capacitance Tolerance	$\pm 5\%$ (J) or $\pm 10\%$ (K) measured at $T = +25^{\circ}\text{C} \pm 5^{\circ}\text{C}$
Dissipation Factor PP Typical (tg δ)	≤ 0.0002 at 10 kHz with $T = 25^{\circ}\text{C} \pm 5^{\circ}\text{C}$
Surge Voltage	$1.5 * V_{NDC}$ for maximum 10 times in a lifetime at $25^{\circ}\text{C} \pm 5^{\circ}\text{C}$
Overvoltage (IEC 61071)	$1.15 * V_{NDC}$ for maximum 30 minutes, once per day
	$1.3 * V_{NDC}$ for maximum 1 minute, once per day
Peak Non-Repetitive Current	$1.5 * I_{PKR}$ for maximum 1,000 times in a lifetime
Insulation Resistance	$IR \times C \geq 30.000$ seconds at 100 VDC 1 minute at $T = +25^{\circ}\text{C} \pm 5^{\circ}\text{C}$
Capacitance Deviation in Operation	$\pm 2.0\%$ maximum on capacitance value measured at $T = +25^{\circ}\text{C} \pm 5^{\circ}\text{C}$
Temperature Storage	-40 to $+80^{\circ}\text{C}$
Storage time	≤ 36 months from the date marked on the label glued to the package
Permissible Relative Humidity - Storage	Annual average $\leq 70\%$, 85% on 30 days/year randomly distributed throughout year. Dewing not admissible.

Life Expectancy

Life Expectancy	100,000 hours at V_{NDC} at hot spot temperature $T_{HS} = +70^{\circ}\text{C}$
	100,000 hours at V_{OP85} at hot spot temperature $T_{HS} = +85^{\circ}\text{C}$
	10,000 hours at V_{OP105} at hot spot temperature $T_{HS} = +105^{\circ}\text{C}$
	500 hours at $0.7 \times V_{OP85}$ at hot spot temperature $T_{HS} = +115^{\circ}\text{C}$
	200 hours at $0.6 \times V_{OP85}$ at hot spot temperature $T_{HS} = +125^{\circ}\text{C}$
Capacitance Drop at End of Life	-5% (typical)
Failure Rate IEC 61709	≤ 200 FIT at V_{OP85} at hot spot temperature $T_{HS} = +85^{\circ}\text{C}$
	≤ 130 FIT at V_{NDC} at hot spot temperature $T_{HS} = +70^{\circ}\text{C}$

Test Method

Test Voltage Between Terminals	$1.5 * V_{NDC}$ for 10 seconds or $1.65 * V_{NDC}$ for 2 seconds, at $T = +25^{\circ}\text{C} \pm 5^{\circ}\text{C}$
Test Voltage Between Terminals and Case	3.2 k VAC 50 Hz for 2 seconds
Damp Heat	IEC 60068-2-78
Change of Temperature	IEC 60068-2-14
Biased Humidity Test 40°C/93% R.H. at V_{NDC} - 1,000 hours	$ \Delta C/C_0 \leq 5\%$ $ \Delta DF/DF_0 \leq 200\%$ (at 10 kHz) $IR \geq 50\%$ of initial limit
Biased Humidity Test 60°C/95% R.H. at V_{NDC} - 1,000 hours	$ \Delta C/C_0 \leq 5\%$ $ \Delta DF/DF_0 \leq 200\%$ (at 10 kHz) $IR \geq 100 \text{ M}\Omega$

Operative Voltage Derating

	Symbol	Voltage (VDC)						Life Expectancy (Hours)
		500	650	800	1,100	1,300	1,500	
Rated Voltage at 70°C (T_{HS})	V_{NDC}	500	650	800	1,100	1,300	1,500	100,000
Operating Voltage at 85°C (T_{HS})	V_{OP85}	450	600	700	900	1,100	1,200	100,000
Operating Voltage at 105°C (T_{HS})	V_{OP105}	350	450	550	700	850	900	10,000

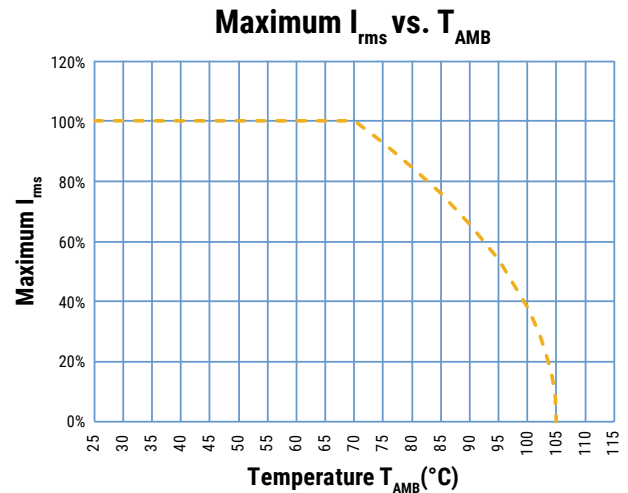
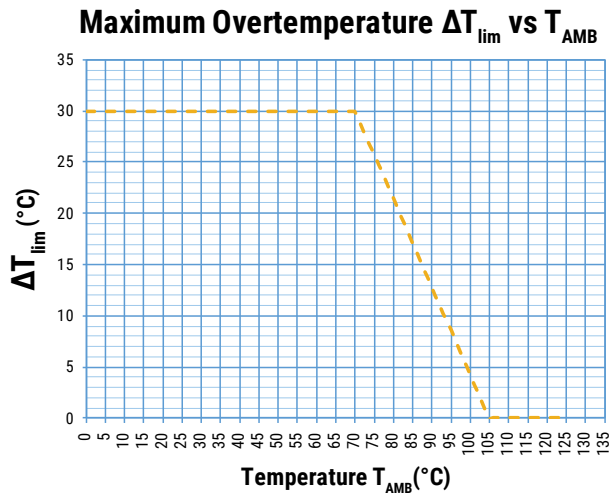

Typical Waveforms

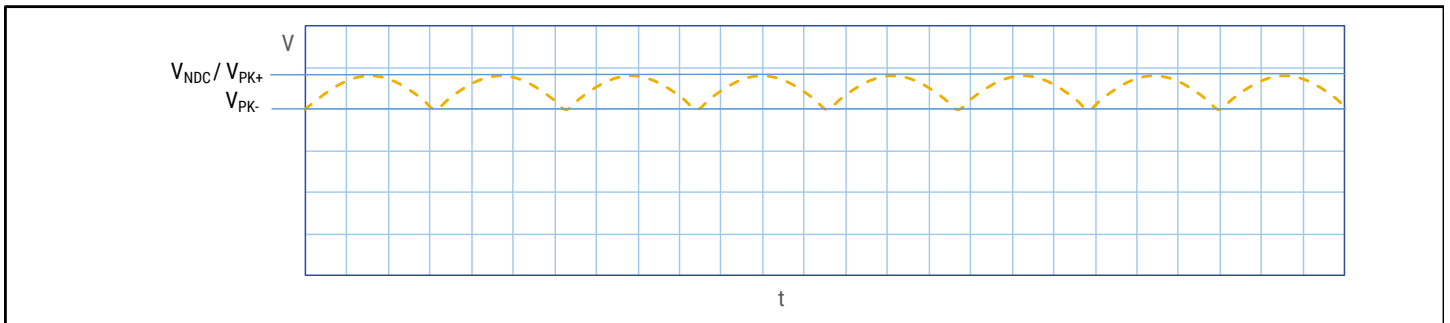
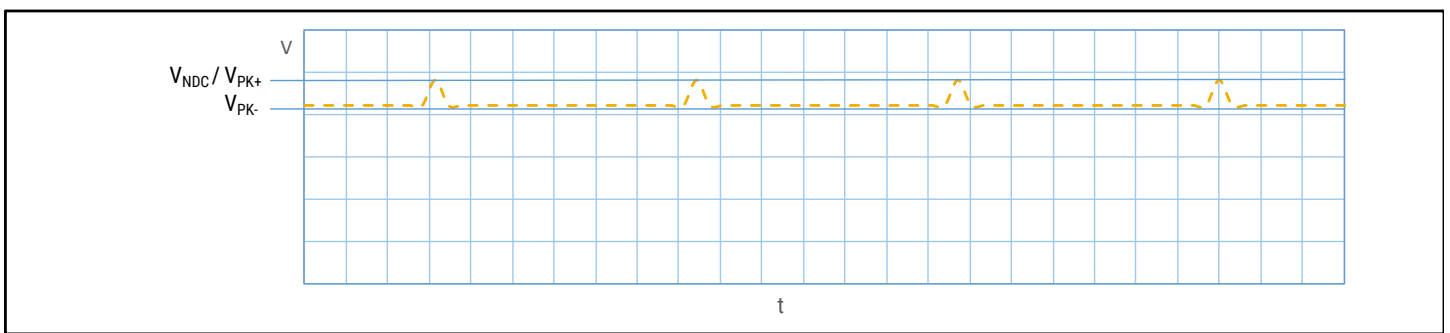
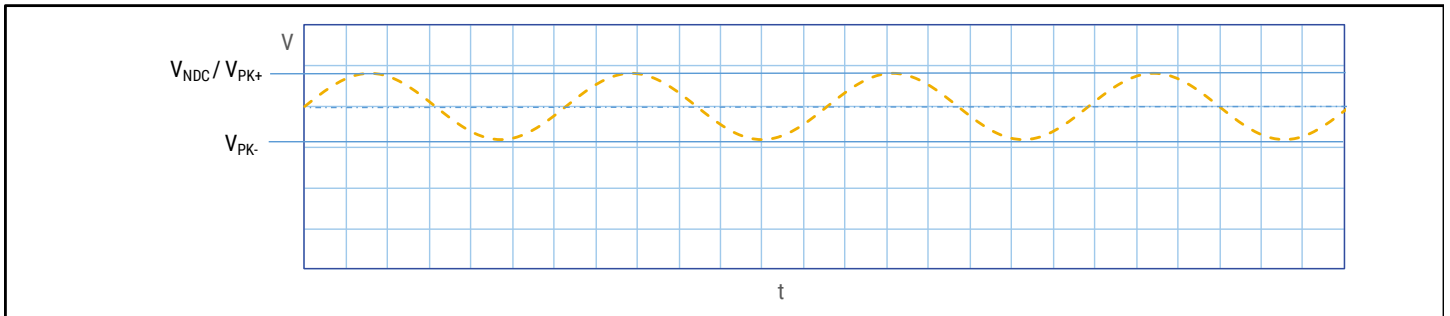

*The applied peak-to-peak ripple voltage shall not exceed $0.1 \times V_{NDC}$.
The peak voltage shall not exceed the rated voltage V_{NDC} .*

Life Expectancy/Failure Quota Graphs

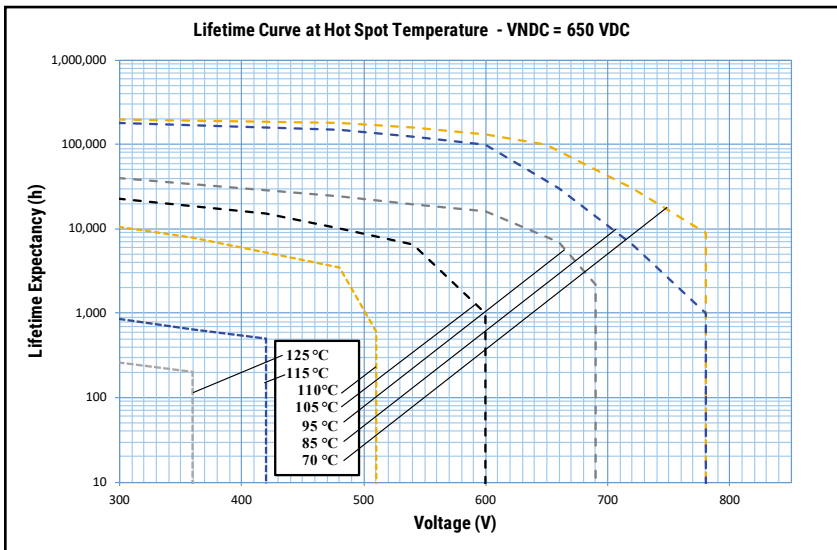
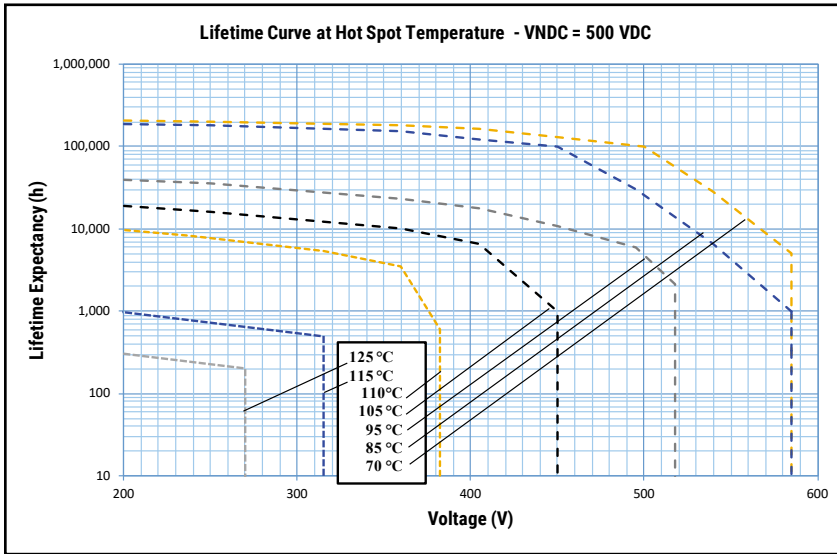

Notes:

$$T_{HS} = T_{AMB} + \Delta T$$

$$\Delta T = ESR * I_{rms}^2 * Rth$$

I_{rms} should be limited to values granting $\Delta T \leq 30^\circ C$

Life Expectancy/Failure Quota Graphs cont.

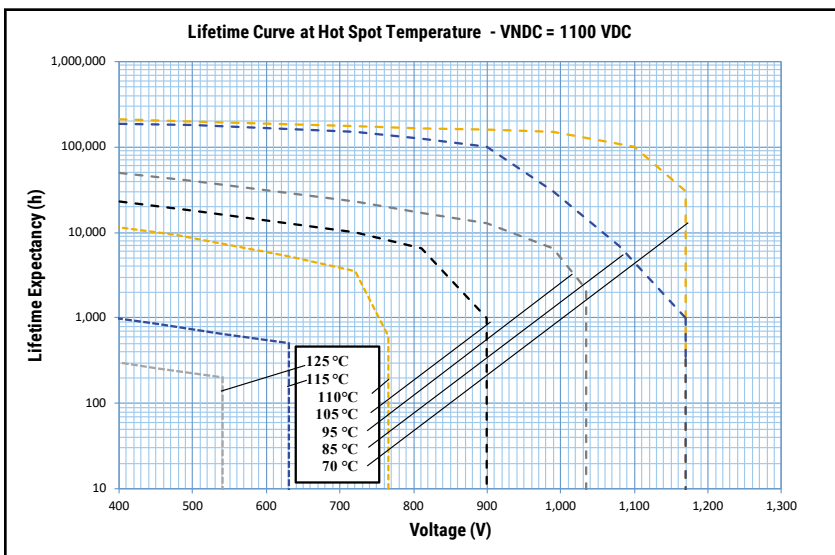
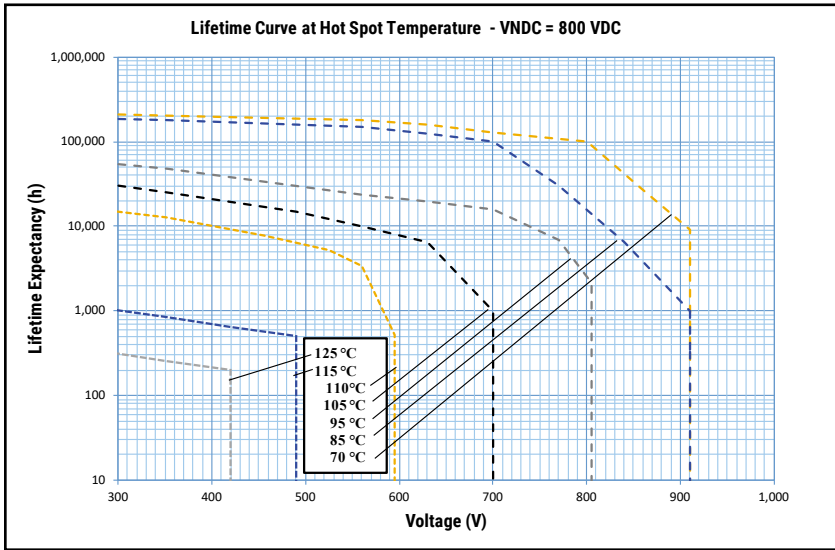

Notes:

$$T_{HS} = T_{AMB} + \Delta T$$

$$\Delta T = ESR * I_{rms}^2 * Rth$$

I_{rms} should be limited to values granting $\Delta T \leq 30^\circ C$

Life Expectancy/Failure Quota Graphs cont.

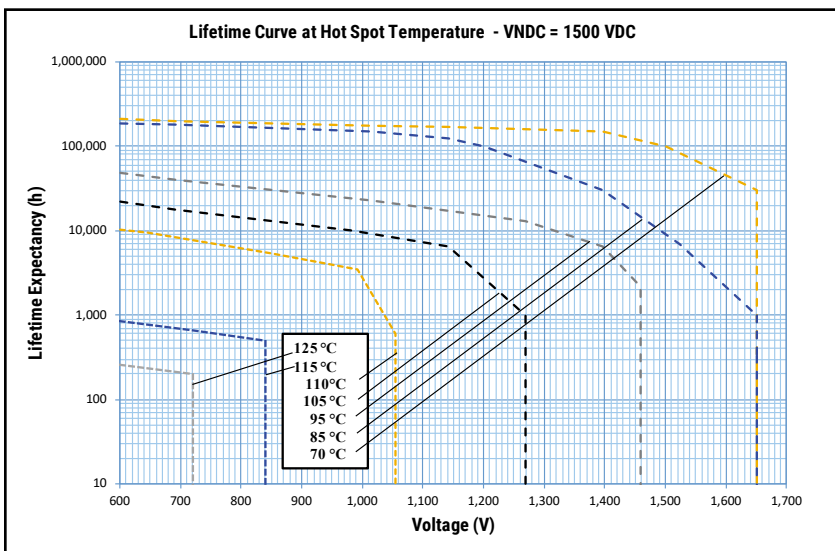
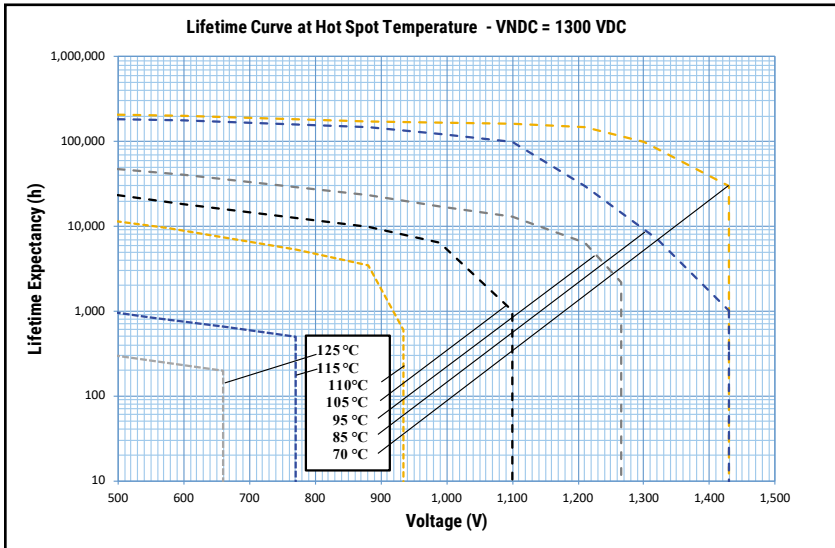

Notes:

$$T_{HS} = T_{AMB} + \Delta T$$

$$\Delta T = ESR * I_{rms}^2 * Rth$$

I_{rms} should be limited to values granting $\Delta T \leq 30^\circ C$

Life Expectancy/Failure Quota Graphs cont.

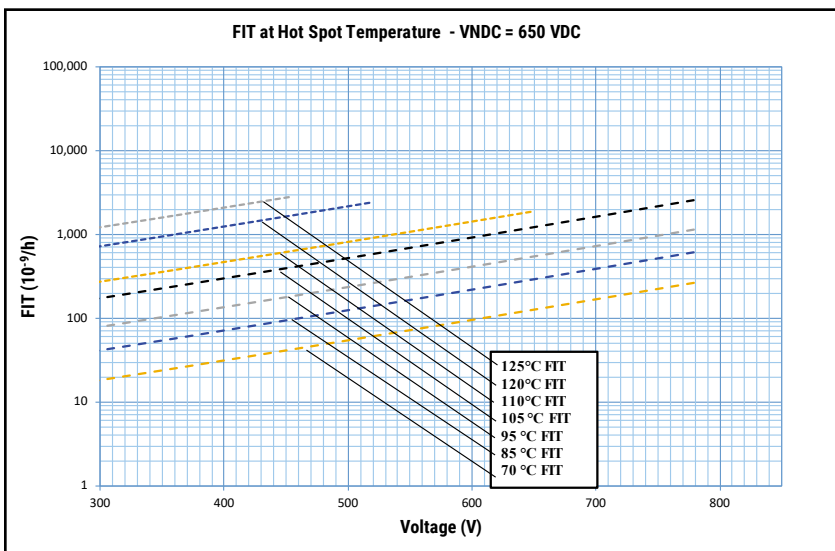
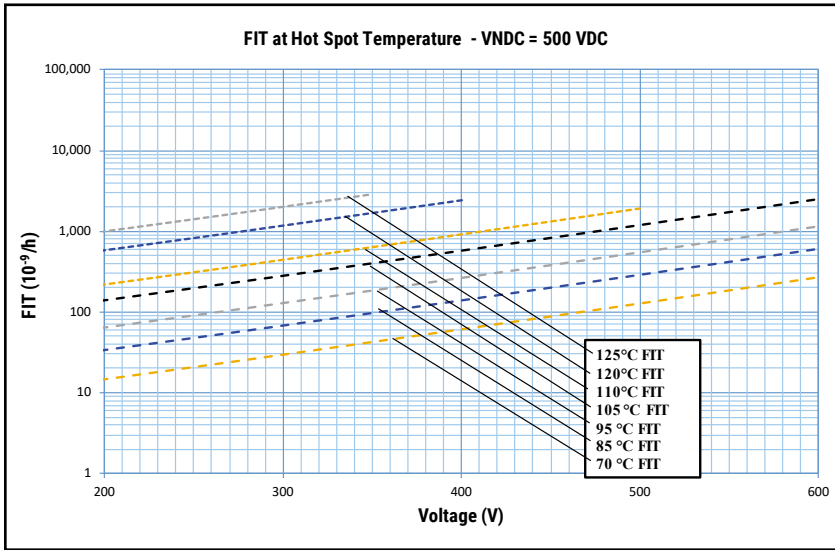

Notes:
 FIT data based on IEC 61709 standard.

Life Expectancy/Failure Quota Graphs cont.

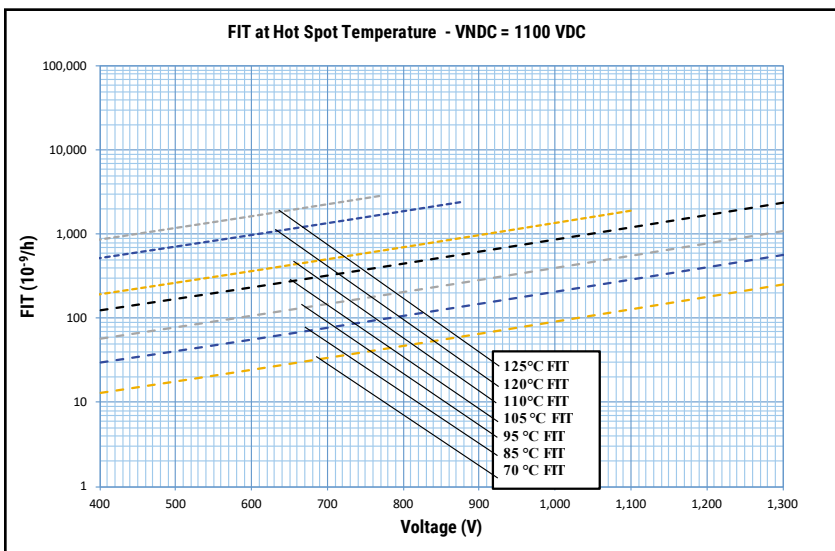
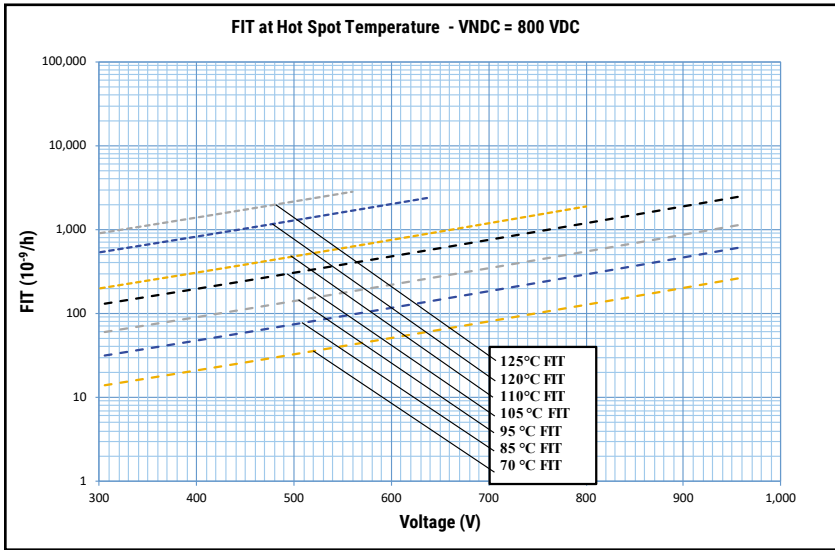

Notes:
 FIT data based on IEC 61709 standard.

Life Expectancy/Failure Quota Graphs cont.

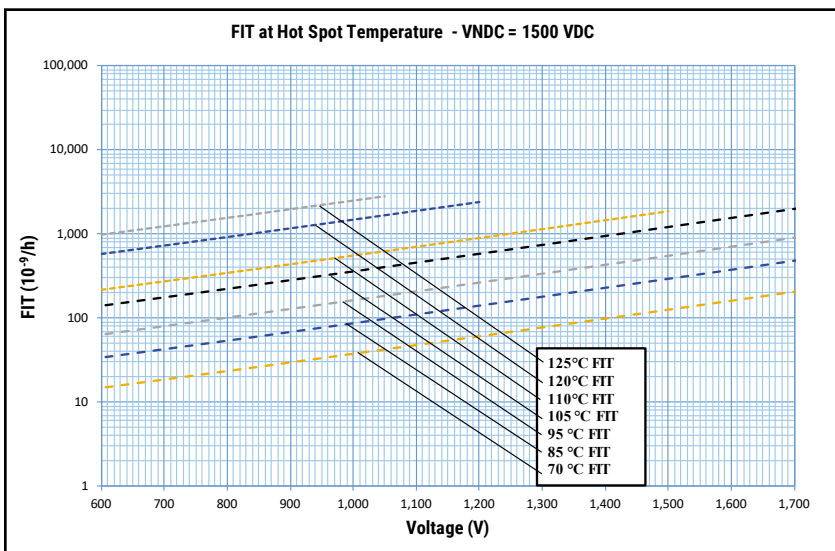
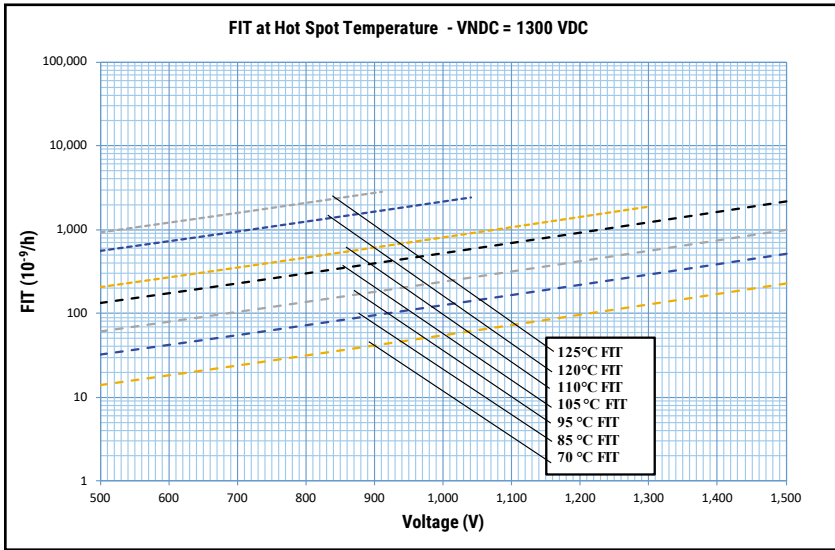

Notes:
 FIT data based on IEC 61709 standard.

Environmental Compliance

As a leading global supplier of electronic components and an environmentally conscious company, KEMET continually aspires to improve the environmental effects of our manufacturing processes and our finished electronic components.

In Europe (RoHS Directive) and in some other geographical areas such as China (China RoHS), legislation has been enacted to prevent or otherwise limit the use of certain hazardous materials, including lead (Pb), in electronic equipment. KEMET monitors legislation globally to ensure compliance and endeavors to adjust our manufacturing processes and/or electronic components as may be required by applicable law.

For military, medical, automotive, and some commercial applications, the use of lead (Pb) in the termination is necessary and/or required by design. KEMET is committed to communicating RoHS compliance to our customers. Information related to RoHS compliance will be provided in data sheets and using specific identifiers on the packaging labels.

All KEMET power film capacitors are RoHS compliant.

Materials & Environment

The selection of raw materials that KEMET uses for the production of its electronic components is the result of extensive experience. KEMET directs specific attention toward environmental protection. KEMET selects its suppliers according to ISO 9001 standards and performs statistical analyses on raw materials before acceptance for use in manufacturing our electronic components. All materials are, to the best of KEMET's knowledge, non-toxic and free from cadmium; mercury; chrome and compounds; polychlorine triphenyl (PCB); bromide and chlorinedioxins bromurate clorurate; CFC and HCFC; and asbestos.

Dissipation Factor

Dissipation factor is a complex function involved with capacitor inefficiency. The $\tan\delta$ may vary up and down with increased temperature. For more information, refer to Performance Characteristics.

Sealing

Hermetically Sealed Capacitors

As the temperature increases, the pressure inside the capacitor increases. If the internal pressure is high enough, it can cause a breach in the capacitor. Such a breach can result in leakage, impregnation, filling fluid, or moisture susceptibility.

Barometric Pressure

The altitude at which hermetically sealed capacitors are operated controls the capacitor's voltage rating. As the barometric pressure decreases, the susceptibility to terminal arc-over increases. Non-hermetic capacitors can be affected by internal stresses due to pressure changes. These effects can be in the form of capacitance changes, dielectric arc-over, and/or low insulation resistance. Altitude can also affect heat transfer. Heat that is generated in an operation cannot be dissipated properly, and high RI^2 losses and eventual failure can result.

Table 1 – Ratings & Part Number Reference

Cap Value (µF)	VDC	Dimensions (mm)					dV/dt V/µs	Ipkr Apk	ESL nH	ESR 70°C at 10 kHz mΩ	Irms* 70°C at 10 kHz Arms	Rth (HS/Amb) (°C/W)	Packaging Quantity	PART NUMBER	
		T	H	L	S	S1									
V_{NDC} at 70°C = 500 VDC; V_{OP85} at 85°C = 450 VDC; V_{OP105} at 105°C = 350 VDC															
5.6	500	11	20	31.5	27.5	\	10	54	17	12.7	6.8	44	256	C4AQLBU4560A1WK	
10	500	13	25	31.5	27.5	\	10	96	22	7.8	9.6	36	234	C4AQLBU5100A1XK	
12.5	500	14	28	31.5	27.5	\	10	122	24	6.7	11.0	33	96	C4AQLBU5125A1YK	
15	500	19	29	31.5	27.5	\	10	147	25	5.8	12.6	29	72	C4AQLBU5150A11K	
25	500	22	37	31.5	27.5	\	10	245	28	4.4	12.6	23	64	C4AQLBU5250A12K	
40	500	20	40	42	37.5	10.2	7	262	12	3.4	19.6	20	58	C4AQLBW5400A3FK	
50	500	28	37	42	37.5	10.2	7	332	10	2.8	22.8	18	36	C4AQLBW5500A3JK	
70	500	30	45	42	37.5	20.3	7	464	13	2.1	29.1	15	36	C4AQLBW5700A3LK	
90	500	35	50	42	37.5	20.3	7	585	14	1.7	35.1	13	30	C4AQLBW5900A3OK	
100	500	30	45	57.5	52.5	20.3	4	442	13	2.9	27.4	12	27	C4AQLBW6100A3MK	
130	500	35	50	57.5	52.5	20.3	4	581	15	2.3	33.3	10	23	C4AQLBW6130A3NK	
170	500	45	56	57.5	52.5	20.3	4	780	17	1.8	41.6	8	18	C4AQLEW6170A3AK	
210	500	45	65	57.5	52.5	20.3	4	840	19	1.6	47.7	7	18	C4AQLEW6210A3BK	
V_{NDC} at 70°C = 650 VDC; V_{OP85} at 85°C = 600 VDC; V_{OP105} at 105°C = 450 VDC															
3.3	650	11	20	31.5	27.5	\	13	41	17	17.0	5.9	44	256	C4AQCBU4330A1WJ	
5.6	650	13	25	31.5	27.5	\	13	71	22	10.7	8.2	36	234	C4AQCBU4560A1XJ	
7	650	14	28	31.5	27.5	\	13	88	24	9.0	9.5	33	96	C4AQCBU4700A1YJ	
10	650	19	29	31.5	27.5	\	13	127	25	6.8	11.7	29	72	C4AQCBU5100A11J	
15	650	22	37	31.5	27.5	\	13	190	28	5.3	12.6	23	64	C4AQCBU5150A12J	
20	650	20	40	42	37.5	10.2	9	172	12	5.3	15.6	20	58	C4AQCBW5200A3FJ	
30	650	28	37	42	37.5	10.2	9	255	10	3.6	19.9	18	36	C4AQCBW5300A3JJ	
40	650	30	45	42	37.5	20.3	9	344	13	2.8	24.9	15	36	C4AQCBW5400A3LJ	
50	650	35	50	42	37.5	20.3	9	430	14	2.3	29.9	13	30	C4AQCBW5500A3OJ	
55	650	30	45	57.5	52.5	20.3	6	319	13	4.1	23.0	12	27	C4AQCBW5550A3MJ	
75	650	35	50	57.5	52.5	20.3	6	435	15	3.1	28.7	10	23	C4AQCBW5750A3NJ	
110	650	45	56	57.5	52.5	20.3	6	625	17	2.2	37.9	8	18	C4AQCEW6110A3AJ	
130	650	45	65	57.5	52.5	20.3	6	754	19	1.9	42.9	7	18	C4AQCEW6130A3BJ	
V_{NDC} at 70°C = 800 VDC; V_{OP85} at 85°C = 700 VDC; V_{OP105} at 105°C = 550 VDC															
2.7	800	11	20	31.5	27.5	\	19	51	17	18.3	5.7	44	256	C4AQIBU4270A1WJ	
4	800	13	25	31.5	27.5	\	19	77	22	12.9	7.5	36	234	C4AQIBU4400A1XJ	
5	800	14	28	31.5	27.5	\	19	96	24	10.7	8.7	33	96	C4AQIBU4500A1YJ	
8	800	19	29	31.5	27.5	\	19	154	25	7.3	11.2	29	72	C4AQIBU4800A11J	
12.5	800	22	37	31.5	27.5	\	19	241	28	5.5	12.6	23	64	C4AQIBU5125A12J	
15	800	20	40	42	37.5	5.1	13	196	12	6.2	14.5	20	58	C4AQIBW5150A3FJ	
20	800	28	37	42	37.5	10.2	13	262	10	4.7	17.4	18	36	C4AQIBW5200A3JJ	
15	800	20	40	42	37.5	10.2	13	196	12	6.2	14.5	20	58	C4AQIBW5150B3FJ	
30	800	30	45	42	37.5	20.3	13	389	13	3.2	23.2	15	36	C4AQIBW5300A3LJ	
40	800	35	50	42	37.5	20.3	13	524	14	2.5	28.7	13	30	C4AQIBW5400A3OJ	
45	800	30	45	57.5	52.5	20.3	9	389	13	4.4	22.3	12	27	C4AQIBW5450A3MJ	
55	800	35	50	57.5	52.5	20.3	9	485	15	3.6	26.4	10	23	C4AQIBW5550A3NJ	
60	800	35	50	57.5	52.5	20.3	9	530	15	3.3	27.5	10	23	C4AQIBW5600A3NJ	
85	800	45	56	57.5	52.5	20.3	9	728	17	2.5	35.8	8	18	C4AQIEW5850A3AJ	
100	800	45	65	57.5	52.5	20.3	9	883	19	2.2	40.6	7	18	C4AQIEW6100A3BJ	
Cap Value (µF)	VDC	T	H	L	S	S1	dV/dt V/µs	Ipkr Apk	nH	mΩ	Arms	(°C/W)	Packaging Quantity	PART NUMBER	
		Dimensions (mm)									ESR 70°C at 10 kHz	Irms* 70°C at 10 kHz	Rth (HS/Amb)		

(*) I_{rms} value that leads to a ΔT of ≈ 30°C in the hot spot > T_{HS} = T_{AMB} + ΔT = 70°C + 30°C = 100°C. Attention: Hot spot at 100°C reduced the life time!

Table 1 – Ratings & Part Number Reference cont.

Cap Value (µF)	VDC	Dimensions (mm)					dV/dt V/µs	lpkr Apk	ESL nH	ESR 70°C at 10 kHz mΩ	Irms* 70°C at 10 kHz Arms	Rth (HS/Amb) (°C/W)	Packaging Quantity	PART NUMBER
		T	H	L	S	S1								
V_{NDC} at 70°C = 1,100 VDC; V_{OP85} at 85°C = 900 VDC; V_{OP105} at 105°C = 700 VDC														
1.5	1,100	11	20	31.5	27.5	\	24	36	17	26.3	4.8	44	256	C4AQQBU4150A1WJ
2.7	1,100	13	25	31.5	27.5	\	24	65	22	15.3	6.9	36	234	C4AQQBU4270A1XJ
3.3	1,100	14	28	31.5	27.5	\	24	79	24	12.9	7.9	33	96	C4AQQBU4330A1VJ
5	1,100	19	29	31.5	27.5	\	24	120	25	9.1	10.1	29	72	C4AQQBU4500A11J
8	1,100	22	37	31.5	27.5	\	24	193	28	6.6	12.6	23	64	C4AQQBU4800A12J
12	1,100	20	40	42	37.5	10.2	16	190	12	6.3	14.4	20	58	C4AQQBW5120A3FJ
14	1,100	28	37	42	37.5	10.2	16	229	10	5.4	16.3	18	36	C4AQQBW5140A3JJ
20	1,100	30	45	42	37.5	20.3	16	321	13	3.9	21.2	15	36	C4AQQBW5200A3LJ
25	1,100	35	50	42	37.5	20.3	16	409	14	3.2	25.5	13	30	C4AQQBW5250A3OJ
30	1,100	30	45	57.5	52.5	20.3	11	324	13	5.2	20.4	12	27	C4AQQBW5300A3MJ
40	1,100	35	50	57.5	52.5	20.3	11	428	15	4.0	25.2	10	23	C4AQQBW5400A3NJ
55	1,100	45	56	57.5	52.5	20.3	11	595	17	3.0	32.5	8	18	C4AQQEW5550A3AJ
65	1,100	45	65	57.5	52.5	20.3	11	717	19	2.6	37.0	7	18	C4AQQEW5650A3BJ
V_{NDC} at 70°C = 1,300 VDC; V_{OP85} at 85°C = 1,100 VDC; V_{OP105} at 105°C = 850 VDC														
1	1,300	11	20	31.5	27.5	\	28	28	17	33.1	4.2	44	256	C4AQBUBU4100A1WJ
1.8	1,300	13	25	31.5	27.5	\	29	52	22	19.1	6.2	36	234	C4AQBUBU4180A1XJ
2.2	1,300	14	28	31.5	27.5	\	29	63	24	16.0	7.1	33	96	C4AQBUBU4220A1YJ
3.3	1,300	19	29	31.5	27.5	\	29	95	25	11.2	9.1	29	72	C4AQBUBU4330A11J
5	1,300	22	37	31.5	27.5	\	29	145	28	8.2	11.8	23	64	C4AQBUBU4500A12J
8	1,300	20	40	42	37.5	10.2	20	157	12	7.9	12.9	20	58	C4AQBUBU4800A3FJ
10	1,300	28	37	42	37.5	10.2	20	196	10	6.3	15.0	18	36	C4AQBUBU5100A3JJ
12	1,300	30	45	42	37.5	20.3	20	235	13	5.3	18.1	15	36	C4AQBUBU5120A3LJ
18	1,300	35	50	42	37.5	20.3	19	350	14	3.7	23.7	13	30	C4AQBUBU5180A3OJ
20	1,300	30	45	57.5	52.5	20.3	13	262	13	6.5	18.3	12	27	C4AQBUBU5200A3MJ
25	1,300	35	50	57.5	52.5	20.3	13	331	15	5.2	22.0	10	23	C4AQBUBU5250A3NJ
27	1,300	35	50	57.5	52.5	20.3	13	354	15	4.9	22.8	10	23	C4AQBUBU5270A3NJ
38	1,300	45	56	57.5	52.5	20.3	13	498	17	3.6	29.8	8	18	C4AQUEW5380A3AJ
45	1,300	45	65	57.5	52.5	20.3	13	596	19	3.1	34.0	7	18	C4AQUEW5450A3BJ
V_{NDC} at 70°C = 1,500 VDC; V_{OP85} at 85°C = 1,200 VDC; V_{OP105} at 105°C = 900 VDC														
1	1,500	11	20	31.5	27.5	\	31	31	17	29.8	4.5	44	256	C4AQSBUBU4100A1WJ
1.5	1,500	13	25	31.5	27.5	\	31	49	22	20.5	6.0	36	234	C4AQSBUBU4150A1XJ
2	1,500	14	28	31.5	27.5	\	32	65	24	15.8	7.1	33	96	C4AQSBUBU4200A1YJ
3	1,500	19	29	31.5	27.5	\	32	95	25	11.1	9.1	29	72	C4AQSBUBU4300A11J
4.5	1,500	22	37	31.5	27.5	\	33	148	28	8.2	11.8	23	64	C4AQSBUBU4450A12J
6	1,500	20	40	42	37.5	10.2	22	132	12	9.4	11.8	20	58	C4AQSBUBU4600A3FJ
8	1,500	28	37	42	37.5	10.2	22	176	10	7.1	14.2	18	36	C4AQSBUBU4800A3JJ
12	1,500	30	45	42	37.5	20.3	22	256	13	4.8	19.0	15	36	C4AQSBUBU5120A3LJ
15	1,500	35	50	42	37.5	20.3	22	326	14	3.9	22.9	13	30	C4AQSBUBU5150A3OJ
17	1,500	30	45	57.5	52.5	20.3	14	236	13	6.9	17.7	12	27	C4AQSBUBU5170A3MJ
22	1,500	35	50	57.5	52.5	20.3	14	308	15	5.4	21.7	10	23	C4AQSBUBU5220A3NJ
32	1,500	45	56	57.5	52.5	20.3	14	460	17	3.8	28.8	8	18	C4AQSEW5320A3AJ
40	1,500	45	65	57.5	52.5	20.3	14	562	19	3.1	33.7	7	18	C4AQSEW5400A3BJ
Cap Value (µF)	VDC	T	H	L	S	S1	V/µs	Apk	nH	mΩ	Arms	(°C/W)	Packaging Quantity	PART NUMBER
		Dimensions (mm)					dV/dt	lpkr	ESL	ESR 70°C at 10 kHz	Irms* 70°C at 10 kHz	Rth (HS/Amb)		

(*) I_{rms} value that leads to a ΔT of ≈ 30°C in the hot spot > T_{HS} = T_{AMB} + ΔT = 70°C + 30°C = 100°C. Attention: Hot spot at 100°C reduced the life time!

Table 2 – Ratings & Part Number Reference for Low Profile Design

Cap Value (µF)	VDC	Dimensions (mm)					dV/dt V/µs	lpkr Apk	ESL nH	ESR 70°C at 10 kHz mΩ	Irms* 70°C at 10 kHz Arms	Rth (HS/Amb) (°C/W)	Packaging Quantity	PART NUMBER
		T	H	L	S	S1								
V_{NDC} at 70°C = 500 VDC; V_{OP85} at 85°C = 450 VDC; V_{OP105} at 105°C = 350 VDC														
5.6	500	21	12.5	32	27.5	\	10	54	11	12.4	6.8	46	192	C4AQLLU4560A11K
8	500	24	15	32	27.5	\	10	81	13	9.1	8.6	39	168	C4AQLLU4800A12K
15	500	31	19	32	27.5	\	10	144	16	5.5	12.6	30	80	C4AQLLU5150A19K
12	500	24	15	41.5	37.5	10.2	6	78	7	10.7	8.6	33	132	C4AQLLW5120A34K
16	500	24	19	41.5	37.5	10.2	7	104	8	8.1	10.5	29	88	C4AQLLW5160A33K
36	500	35	24	42	37.5	20.3	6	232	9	3.7	17.8	23	60	C4AQLLW5360A36K
45	500	43	25	42	37.5	20.3	7	294	9	3.0	21.4	19	48	C4AQLLW5450A38K
V_{NDC} at 70°C = 650 VDC; V_{OP85} at 85°C = 600 VDC; V_{OP105} at 105°C = 450 VDC														
3.3	650	21	12.5	32	27.5	\	13	41	11	16.8	5.8	46	192	C4AQCLU4330A11J
5	650	24	15	32	27.5	\	13	63	13	11.5	7.7	39	168	C4AQCLU4500A12J
10	650	31	19	32	27.5	\	13	127	16	6.4	11.7	30	80	C4AQCLU5100A19J
7.5	650	24	15	41.5	37.5	10.2	9	64	7	13.8	7.6	33	132	C4AQLLW4750A34J
10	650	24	19	41.5	37.5	10.2	9	86	8	10.4	9.3	29	88	C4AQLW5100A33J
20	650	35	24	42	37.5	20.3	9	172	10	5.3	14.8	23	60	C4AQLW5200A36J
30	650	43	25	42	37.5	20.3	8	245	9	3.6	19.5	19	48	C4AQLW5300A38K
V_{NDC} at 70°C = 800 VDC; V_{OP85} at 85°C = 700 VDC; V_{OP105} at 105°C = 550 VDC														
2.7	800	21	12.5	32	27.5	\	19	51	11	18.0	5.6	46	192	C4AQLU4270A11J
3.8	800	24	15	32	27.5	\	19	73	13	13.2	7.1	39	168	C4AQLU4380A12J
7.5	800	31	19	32	27.5	\	19	145	16	7.3	10.9	30	80	C4AQLU4750A19J
5.8	800	24	15	41.5	37.5	10.2	13	75	7	15.7	7.1	33	132	C4AQLW4580A34J
8	800	24	19	41.5	37.5	10.2	13	104	8	11.4	8.9	29	88	C4AQLW4800A33J
15	800	35	24	42	37.5	20.3	13	196	9	6.2	13.7	23	60	C4AQLW5150A36J
22	800	43	25	42	37.5	20.3	13	288	9	4.3	17.9	19	48	C4AQLW5220A38J
V_{NDC} at 70°C = 1,100 VDC; V_{OP85} at 85°C = 900 VDC; V_{OP105} at 105°C = 700 VDC														
1.5	1,100	21	12.5	32	27.5	\	24	36	11	26.0	4.7	46	192	C4AQLU4150A11J
2.5	1,100	24	15	32	27.5	\	24	60	13	16.1	6.5	39	168	C4AQLU4250A12J
4.8	1,100	31	19	32	27.5	\	24	116	16	9.0	9.8	30	80	C4AQLU4480A19J
3.8	1,100	24	15	41.5	37.5	10.2	16	62	7	19.3	6.4	33	132	C4AQLW4380A34J
5	1,100	24	19	41.5	37.5	10.2	16	81	8	14.7	7.8	29	88	C4AQLW4500A33J
10	1,100	35	24	42	37.5	20.3	16	163	9	7.4	12.5	23	60	C4AQLW5100A36J
14	1,100	43	25	42	37.5	20.3	16	229	9	5.4	15.9	19	48	C4AQLW5140A38J
V_{NDC} at 70°C = 1,300 VDC; V_{OP85} at 85°C = 1,100 VDC; V_{OP105} at 105°C = 850 VDC														
1	1,300	21	12.5	32	27.5	\	28	28	11	32.9	4.2	46	192	C4AQLU4100A11J
1.8	1,300	24	15	32	27.5	\	29	52	13	18.8	6.0	39	168	C4AQLU4180A12J
3.3	1,300	31	19	32	27.5	\	29	95	16	10.8	9.0	30	80	C4AQLU4330A19J
2.6	1,300	24	15	41.5	37.5	10.2	19	51	7	23.7	5.8	33	132	C4AQLW4260A34J
3.5	1,300	24	19	41.5	37.5	10.2	20	68	8	17.6	7.1	29	88	C4AQLW4350A33J
7.5	1,300	35	24	42	37.5	20.3	20	147	9	8.3	11.8	23	60	C4AQLW4750A36J
10	1,300	43	25	42	37.5	20.3	20	196	9	6.3	14.7	19	48	C4AQLW5100A38J
V_{NDC} at 70°C = 1,500 VDC; V_{OP85} at 85°C = 1,200 VDC; V_{OP105} at 105°C = 900 VDC														
1	1,500	21	12.5	32	27.5	\	31	31	11	29.6	4.4	46	192	C4AQLU4100A11J
1.5	1,500	24	15	32	27.5	\	31	47	13	20.1	5.8	39	168	C4AQLU4150A12J
2.8	1,500	31	19	32	27.5	\	31	87	16	11.4	8.8	30	80	C4AQLU4280A19J
2.2	1,500	24	15	41.5	37.5	10.2	21	46	7	25.2	5.6	33	132	C4AQLW4220A34J
3	1,500	24	19	41.5	37.5	10.2	21	63	8	18.5	7	29	88	C4AQLW4300A33J
6	1,500	35	24	42	37.5	20.3	21	127	9	9.4	11.1	23	60	C4AQLW4600A36J
8	1,500	43	25	42	37.5	20.3	21	170	9	7.1	13.9	19	48	C4AQLW4800A38J
Cap Value (µF)	VDC	T	H	L	S	S1	V/µs	Apk	nH	mΩ	Arms	(°C/W)	Packaging Quantity	PART NUMBER
		Dimensions (mm)					dV/dt	lpkr	ESL	ESR 70°C at 10 kHz	Irms* 70°C at 10 kHz	Rth (HS/Amb)		

(*) I_{rms} value that leads to a ΔT of ≈ 30°C in the hot spot > T_{HS} = T_{AMB} + ΔT = 70°C + 30°C = 100°C. Attention: Hot spot at 100°C reduced the life time!

Soldering Process

The implementation of the RoHS directive has resulted in the selection of SnAuCu (SAC) alloys, or SnCu alloys, as the primary solder material. This has increased the liquidus temperature from 183°C for a SnPb eutectic alloy to 217 – 221°C for new alloys. As a result, the heat stress to the components, even in wave soldering, has increased considerably due to higher pre-heat and wave temperatures. Polypropylene capacitors are especially sensitive to heat (the melting point of polypropylene is 160 – 170°C). Wave soldering can be destructive, especially for mechanically small polypropylene capacitors (with lead spacing of 5 – 15 mm), and great care must be taken during soldering. The recommended solder profiles from KEMET should be used. Contact KEMET with any questions. In general, the wave soldering curve from IEC Publication 61760-1 Edition 2 serves as a solid guideline for successful soldering. See Figure 1.

Reflow soldering is not recommended for through-hole film capacitors. Exposing capacitors to a soldering profile in excess of the recommended limits may result in degradation or permanent damage to the capacitors.

Do not place the polypropylene capacitor through an adhesive curing oven to cure resin for surface mount components. Insert through-hole parts after curing the surface mount parts. Contact KEMET to discuss the actual temperature profile in the oven, if through-hole components must pass through the adhesive curing process. A maximum two soldering cycles is recommended. Allow time for the capacitor surface temperature to return to normal before the second soldering cycle.

Manual Soldering Recommendations

Following is the recommendation for manual soldering with a soldering iron.

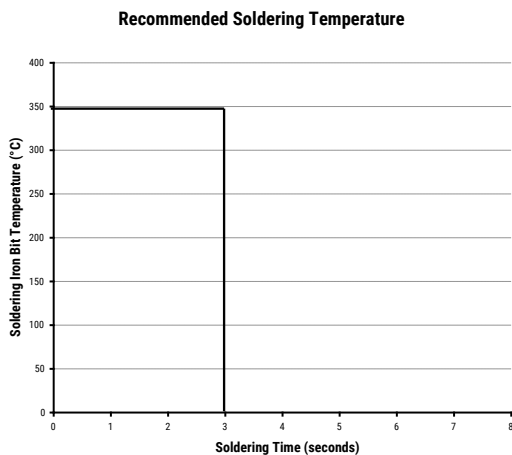

The soldering iron tip temperature should be set at 350°C (+10°C maximum) with the soldering duration not to exceed more than 3 seconds.

Wave Soldering Recommendations

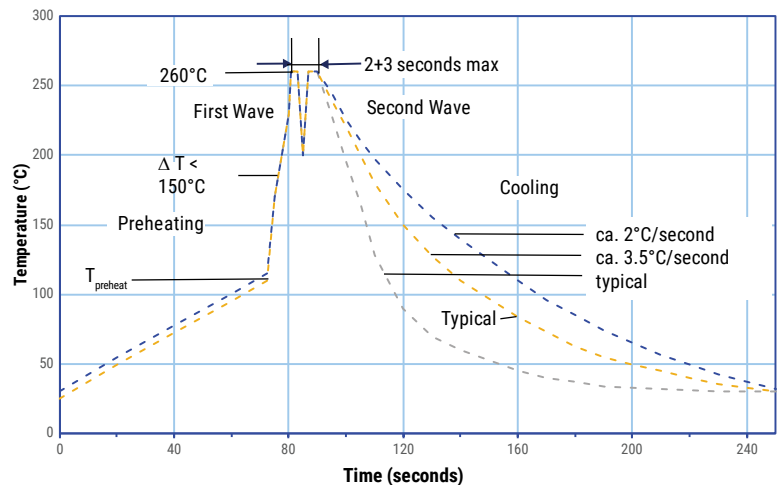

Soldering Process cont.

Wave Soldering Recommendations cont.

1. The tables indicates the maximum set-up temperature of the soldering process

Dielectric Film Material	Maximum Preheat Temperature		Maximum Peak Soldering Temperature	
	Capacitor Pitch ≤ 15 mm	Capacitor Pitch > 15 mm	Capacitor Pitch ≤ 15 mm	Capacitor Pitch > 15 mm
Polyester	130°C	130°C	270°C	270°C
Polypropylene	110°C	130°C	260°C	270°C
Paper	130°C	140°C	270°C	270°C
Polyphenylene Sulphide	150°C	160°C	270°C	270°C

2. The maximum temperature measured inside the capacitor: set the temperature so that inside the element the maximum temperature is below the limit.

Dielectric Film Material	Maximum Temperature Measured Inside the Element
Polyester	160°C
Polypropylene	110°C
Paper	160°C
Polyphenylene Sulphide	160°C

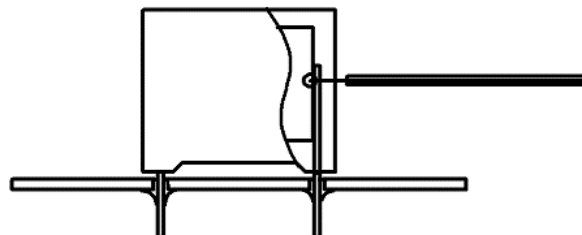

Temperature monitored inside the capacitor.

Selective Soldering Recommendations

Selective dip soldering is a variation of reflow soldering. In this method, the printed circuit board with through-hole components to be soldered is pre-heated and transported over the solder bath, as in normal flow soldering, without touching the solder. When the board is over the bath, it is stopped. Pre-designed solder pots are lifted from the bath with molten solder, only at the places of the selected components, and pressed against the lower surface of the board to solder the components.

The temperature profile for selective soldering is similar to the double wave flow soldering outlined in this document. However, instead of two baths, there is only one with a time from 3 – 10 seconds. In selective soldering, the risk of overheating is greater than in double wave flow soldering, and great care must be taken so that the parts do not overheat.

Mounting

Resistance to Vibration and Mechanical Shock

AEC-Q200 Mechanical Stress Tests:

Mechanical Shock	MIL-SDT-202 Method 213	Test condition C Peak value 100 g, duration 6 ms, half-sine-wave (see MIL-HDBK for details)
Vibration	MIL-SDT-202 Method 204	5 g for 20 minutes, 12 cycles each of 3 orientations Use 8"X5" PCB, .031" thick. 7 secure points on one 8" side and 2 secure points at corners of opposite sides. Parts mounted within 2" from any secure point. Test from 10 – 2,000 Hz.

The capacitors are designed for PCB mounting.
 The stand-off pipes must be in good contact with the printed circuit board.
 The capacitor body has to be properly fixed (e.g. clamped or glued).

Construction

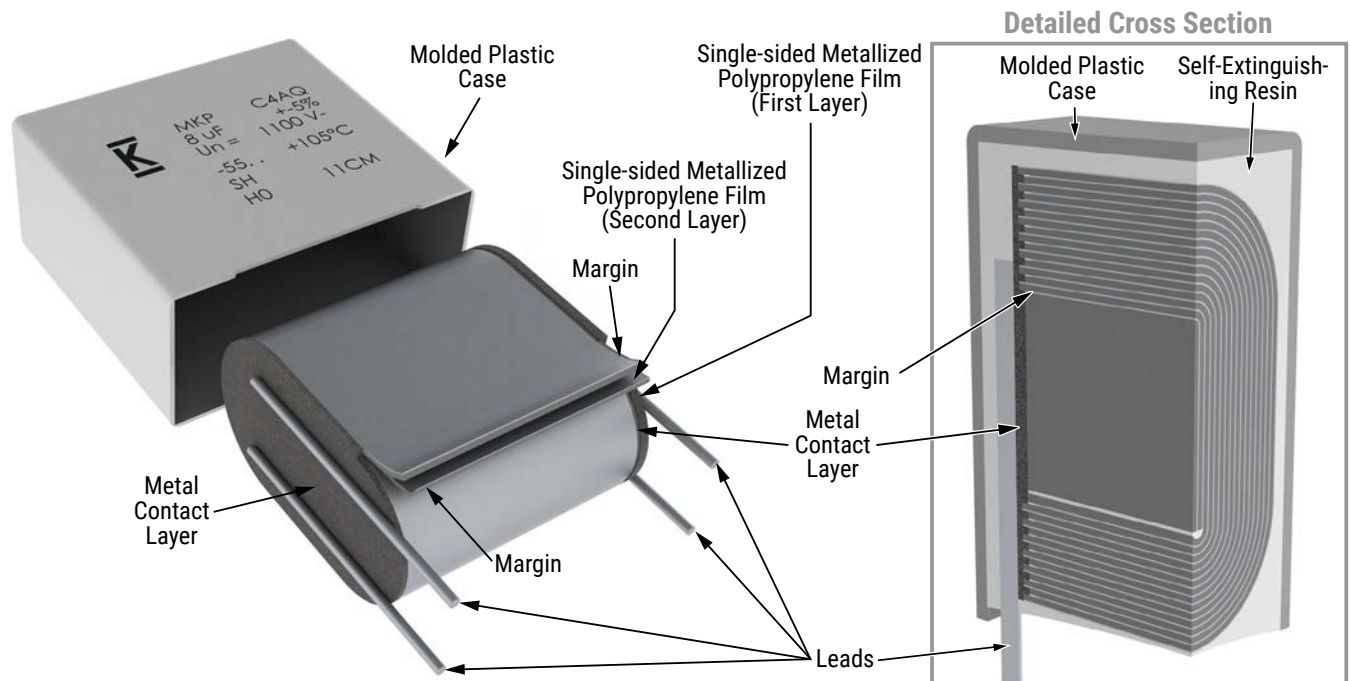

Construction cont.

Low Profile Version:

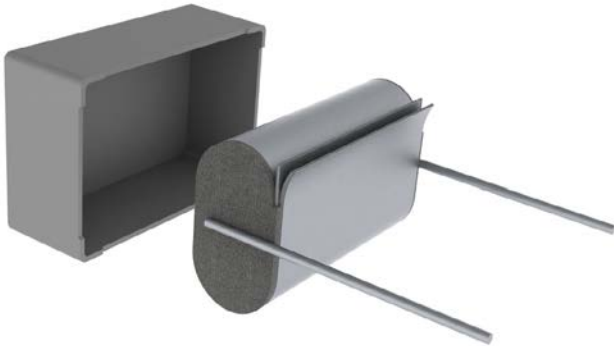

Winding Scheme:

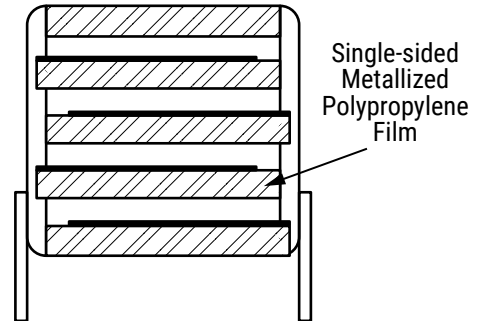

Marking

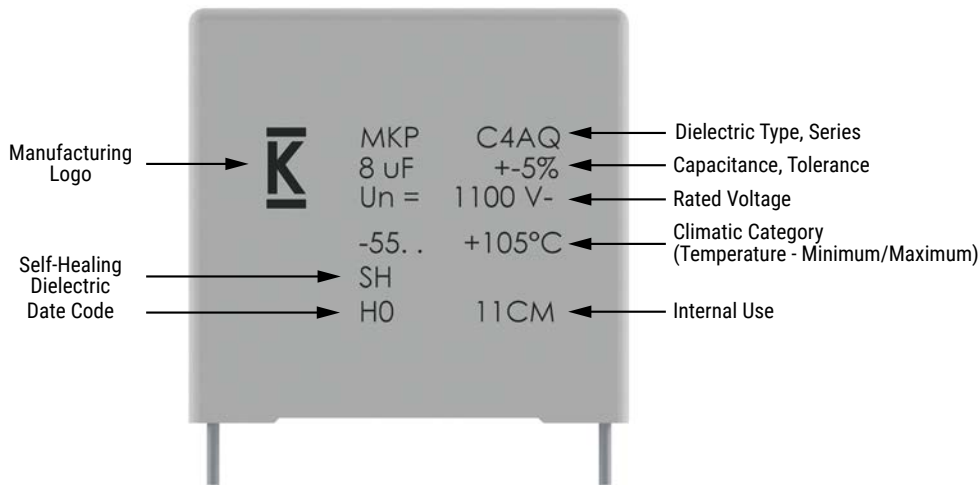

Manufacturing Date Code (IEC-60062)

Y = Year, Z = Month

Year	Code	Year	Code	Year	Code	Month	Code	Month	Code
2010	A	2017	J	2024	S	January	1	July	7
2011	B	2018	K	2025	T	February	2	August	8
2012	C	2019	L	2026	U	March	3	September	9
2013	D	2020	M	2027	V	April	4	October	0
2014	E	2021	N	2028	W	May	5	November	N
2015	F	2022	P	2029	X	June	6	December	D
2016	H	2023	R	2030	A				

KEMET Electronics Corporation Sales Offices

For a complete list of our global sales offices, please visit www.kemet.com/sales.

Disclaimer

All product specifications, statements, information and data (collectively, the "Information") in this datasheet are subject to change. The customer is responsible for checking and verifying the extent to which the Information contained in this publication is applicable to an order at the time the order is placed. All Information given herein is believed to be accurate and reliable, but it is presented without guarantee, warranty, or responsibility of any kind, expressed or implied.

Statements of suitability for certain applications are based on KEMET Electronics Corporation's ("KEMET") knowledge of typical operating conditions for such applications, but are not intended to constitute – and KEMET specifically disclaims – any warranty concerning suitability for a specific customer application or use. The Information is intended for use only by customers who have the requisite experience and capability to determine the correct products for their application. Any technical advice inferred from this Information or otherwise provided by KEMET with reference to the use of KEMET's products is given gratis, and KEMET assumes no obligation or liability for the advice given or results obtained.

Although KEMET designs and manufactures its products to the most stringent quality and safety standards, given the current state of the art, isolated component failures may still occur. Accordingly, customer applications which require a high degree of reliability or safety should employ suitable designs or other safeguards (such as installation of protective circuitry or redundancies) in order to ensure that the failure of an electrical component does not result in a risk of personal injury or property damage.

Although all product-related warnings, cautions and notes must be observed, the customer should not assume that all safety measures are indicated or that other measures may not be required.

KEMET is a registered trademark of KEMET Electronics Corporation.

Looking for pricing, stock, or lifecycle information?

Click below to explore more details on WIN SOURCE:

 [View C4AQLBU4560A1WK on WIN SOURCE](#)

 [Kemet Information](#)

Optimize Your Supply Chain with WIN SOURCE Solutions

-  Global Sourcing Solution
-  Obsolete Management
-  Cost Control Management
-  Shortage Management
-  Alternative Solution
-  Excess Inventory Management