



**THE DATASHEET OF  
BFC233660222**





## Interference Suppression Film Capacitors MKP Radial Potted Type

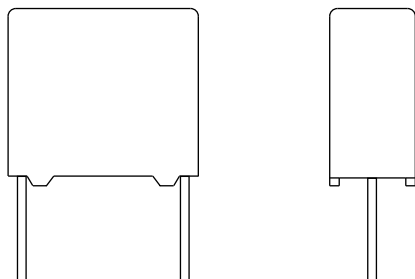

### FEATURES

- Compliant with IEC 60381-14: AMD1 grade IIB for pitch  $\geq 15$  mm
  - THB: 85 °C, 85 % RH, 500 h at  $U_{RAC}$
- Compliant with IEC 60381-14: AMD1 grade IA for pitch  $< 15$  mm
  - THB: 40 °C, 93 % RH, 21 days at  $U_{RAC}$
- Material categorization:  
for definitions of compliance please see [www.vishay.com/doc?99912](http://www.vishay.com/doc?99912)



**RoHS**  
COMPLIANT

### APPLICATIONS

Y2 class

For Y2 electromagnetic interference suppression between line and ground applications (50 Hz / 60 Hz) with a maximum mains voltage of 300  $V_{AC}$ .

For application limitations refer to section "Application Notes".

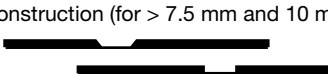
QUICK REFERENCE DATA	
Capacitance range (E12 series)	0.001 $\mu$ F to 0.047 $\mu$ F (preferred values according to E6)
Capacitance tolerance	$\pm 20$ %; $\pm 10$ %
Climatic testing class according to EN60068-1	55/105/56/C for product volumes $\leq 1750$ mm <sup>3</sup> 55/105/56/B for product volumes $> 1750$ mm <sup>3</sup>
Rated AC voltage	300 $V_{AC}$ ; 50 Hz to 60 Hz
Permissible DC voltage	1000 $V_{DC}$
Maximum application temperature	105 °C
Reference standards	IEC 60384-14:2013 IEC 60384-14:2013 / AMD1:2016 EN 60384-14:2013 + AMD1:2016 IEC 60065 requires, pass. flamm. class B for volumes $> 1750$ mm <sup>3</sup> UL 60384-14
Dielectric	Polypropylene film
Electrodes	Metallized film
Construction	Series construction (for $> 10$ mm pitch)  Triple construction (for $> 7.5$ mm and 10 mm pitch) 
Encapsulation	Plastic case, epoxy resin sealed, flame retardant UL-class 94 V-0
Leads	Tinned wire
Marking	C-value; tolerance; rated voltage; sub-class; manufacturer's type designation; code for dielectric material; manufacturer location; year and week

### Note

- For more detailed data and test requirements, contact: [rfi@vishay.com](mailto:rfi@vishay.com)

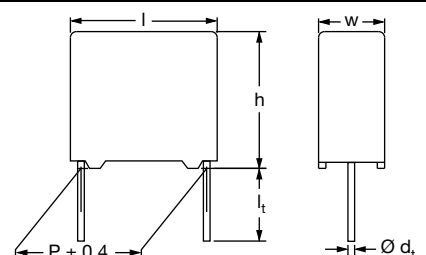
DIMENSIONS in millimeters



**COMPOSITION OF CATALOG NUMBER**

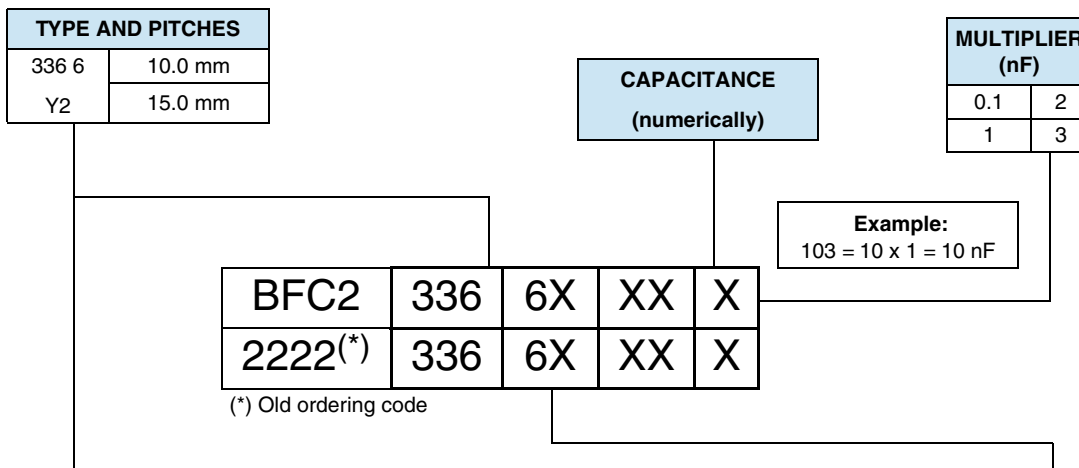

TYPE	PACKAGING	LEAD CONFIGURATION	C-TOL.	PREFERRED TYPES
336 6 Y2	Loose in box	Lead length 3.5 mm + 1 mm/- 0.5 mm (pitch = 10 mm) or 3.5 mm ± 0.3 mm (pitch = 15 mm)	± 20 %	BFC2 336 60...
		Lead length 25.0 mm ± 2.0 mm		BFC2 336 66...
TYPE	PACKAGING	LEAD CONFIGURATION	C-TOL.	ON REQUEST
336 6 Y2	Loose in box	Lead length 3.5 mm + 1 mm/- 0.5 mm (pitch = 10 mm) or 3.5 mm ± 0.3 mm (pitch = 15 mm)	± 10 %	BFC2 336 61...
		Lead length 25.0 mm ± 2.0 mm		BFC2 336 67...
	Taped on reel <sup>(1)</sup>	H = 18.5 mm; P <sub>0</sub> = 12.7 mm; reel diameter 500 mm	± 20 %	BFC2 336 63...
			± 10 %	BFC2 336 64...

**Note**

<sup>(1)</sup> For detailed tape specification refer to packaging information: [www.vishay.com/doc?28139](http://www.vishay.com/doc?28139)

SPECIFIC REFERENCE DATA	
DESCRIPTION	VALUE
Rated AC voltage (U <sub>RAC</sub> )	300 V
Permissible DC voltage (U <sub>RDC</sub> )	1000 V
Tangent of loss angle	at 10 kHz
	≤ 20 x 10 <sup>-4</sup>
Rated voltage pulse slope (dU/dt) <sub>R</sub> at 420 V <sub>DC</sub>	200 V/μs
R between leads, for C ≤ 0.33 μF at 100 V; 1 min	> 15 000 MΩ
R between leads and case; 100 V; 1 min	> 30 000 MΩ
Withstanding (DC) voltage (cut off current 10 mA) <sup>(1)</sup> ; rise time ≤ 1000 V/s	3400 V; 1 min
Withstanding (AC) voltage between leads and case	2100 V; 1 min

**Note**

<sup>(1)</sup> See "Voltage Proof Test for Metalized Film Capacitors": [www.vishay.com/doc?28169](http://www.vishay.com/doc?28169)



ELECTRICAL DATA AND ORDERING CODE									
U <sub>RAC</sub> (V)	CAP. (μF)	DIMENSIONS w x h x l (mm)	MASS (g) <sup>(3)</sup>	CATALOG NUMBER BFC2 336 6..... AND PACKAGING					
				LOOSE IN BOX				REEL (500 mm) <sup>(1)(2)</sup>	
				l <sub>t</sub> = 3.5 mm + 1 mm/- 0.5 mm (10 mm) OR 3.5 mm ± 0.3 mm (= 15 mm)		l <sub>t</sub> = 25.0 mm ± 2.0 mm		H = 18.5 mm; P <sub>0</sub> = 12.7 mm	
				LAST 5 DIGITS OF CATALOG NUMBER	SPQ	LAST 5 DIGITS OF CATALOG NUMBER	SPQ	LAST 5 DIGITS OF CATALOG NUMBER	SPQ
<b>PITCH = 10.0 mm ± 0.4 mm; d<sub>t</sub> = 0.6 mm ± 0.06 mm; C-TOL. = ± 20 %</b>									
300	0.0010	4.0 x 10.0 x 12.5	0.6	60102	1000	66102	1250	63102	1400
	0.0015			60152		66152		63152	
	0.0022			60222		66222		63222	
	0.0033			60332		66332		63332	
	0.0047	5.0 x 11.0 x 12.5	0.82	60472	1000	66472	1000	63472	1100
	0.0068			60682		66682		63682	
<b>PITCH = 15.0 mm ± 0.4 mm; d<sub>t</sub> = 0.6 mm ± 0.06 mm; C-TOL. = ± 20 %</b>									
300	0.0068	5.0 x 11.0 x 17.5	1.0	69005	1000	69009	1000	69006	1100
	0.010			60103		66103		63103	
	0.015	6.0 x 12.0 x 17.5	1.4	60153	66153	63153	900		
<b>PITCH = 15.0 mm ± 0.4 mm; d<sub>t</sub> = 0.8 mm ± 0.08 mm; C-TOL. = ± 20 %</b>									
300	0.022	7.0 x 13.5 x 17.5	1.8	60223	750	66223	500	63223	800
	0.033	8.5 x 15.0 x 17.5	2.4	60333		66333		63333	650
	0.047	10.0 x 16.5 x 17.5	3.0	60473	500	66473	450	63473	600
<b>PITCH = 10.0 mm ± 0.4 mm; d<sub>t</sub> = 0.6 mm ± 0.06 mm; C-TOL. = ± 10 %</b>									
300	0.0010	4.0 x 10.0 x 12.5	0.6	61102	1000	67102	1250	64102	1400
	0.0012			61122		67122		64122	
	0.0015			61152		67152		64152	
	0.0018			61182		67182		64182	
	0.0022			61222		67222		64222	
	0.0027			61272		67272		64272	
	0.0033			61332		67332		64332	
	0.0039	61392	67392	64392					
	0.0047	5.0 x 11.0 x 12.5	1.1	61472	1000	67472	1000	64472	1100
	0.0056			61562		67562		64562	
<b>PITCH = 15.0 mm ± 0.4 mm; d<sub>t</sub> = 0.80 mm ± 0.08 mm; C-TOL. = ± 10 %</b>									
300	0.0056	5.0 x 11.0 x 17.5	1.0	69001	1000	69007	1000	69003	1100
	0.0068			61682		67682		64682	
	0.0082			61822		67822		64822	
	0.010			61103		67103		64103	
	0.012			61123		67123		64123	
	0.015	6.0 x 12.0 x 17.5	1.4	61153	500	67153	450	61153	900
0.018	61183			67183		64183			
<b>PITCH = 15.0 mm ± 0.4 mm; d<sub>t</sub> = 0.80 mm ± 0.08 mm; C-TOL. = ± 10 %</b>									
300	0.022	7.0 x 13.5 x 17.5	1.8	61223	750	67223	500	64223	800
	0.027	8.5 x 15.0 x 17.5	2.4	61273		67273		64273	650
	0.033			61333	67333	64333	600		
	0.039	10.0 x 16.5 x 17.5	3.0	61393	500	67393	450	61393	600
	0.047			61473		67473		64473	

Notes

- SPQ = Standard packing quantity
- (1) H = in-tape height; P<sub>0</sub> = sprocket hole distance; for detailed specifications refer to packaging information: [www.vishay.com/doc?28139](http://www.vishay.com/doc?28139)
- (2) Reel diameter = 365 mm is available on request
- (3) Weight for short lead product only



APPROVALS				
SAFETY APPROVALS Y2	VOLTAGE	VALUE	FILE NUMBERS	LINKS
EN 60384-14 (ENEC) (= IEC 60384-14 ed-4 (2013))	300 V <sub>AC</sub>	1 nF to 47 nF	ENEC16/FI/21/01065	<a href="http://www.vishay.com/doc?28204">www.vishay.com/doc?28204</a>
UL 60384-14	300 V <sub>AC</sub>	1 nF to 47 nF	E354331	<a href="http://www.vishay.com/doc?28189">www.vishay.com/doc?28189</a>
CSA-E384-14	300 V <sub>AC</sub>	1 nF to 47 nF	E354331	
CB-test-certificate	300 V <sub>AC</sub>	1 nF to 47 nF	FI-39831/A1	<a href="http://www.vishay.com/doc?28203">www.vishay.com/doc?28203</a>
The ENEC-approval together with the CB-certificate replace all national marks of the following countries (they have already signed the ENEC-agreement): Austria; Belgium; Czech. Republic; Denmark; Finland; France; Germany; Greece; Hungary; Ireland; Italy; Luxembourg; Netherlands; Norway; Portugal; Slovenian; Spain; Switzerland and United Kingdom.				

**MOUNTING**

**Normal Use**

The capacitors are designed for mounting on printed-circuit boards. The capacitors packed in bandoleers are designed for mounting in printed-circuit boards by means of automatic insertion machines.

For detailed tape specifications refer to packaging information: [www.vishay.com/doc?28139](http://www.vishay.com/doc?28139)

**Specific Method of Mounting to Withstand Vibration and Shock**

In order to withstand vibration and shock tests, it must be ensured that the stand-off pips are in good contact with the printed-circuit board:

- The capacitors shall be mechanically fixed by the leads

**Space Requirements on Printed Circuit Board**

The maximum space for length ( $l_{max}$ ), width ( $w_{max}$ ), and height ( $h_{max}$ ) of film capacitors to take in account on the printed circuit board is shown in the drawings.

- For products with pitch  $\leq 15$  mm,  $\Delta w = \Delta l = 0.3$  mm;  $\Delta h = 0.1$  mm

Eccentricity defined as in drawing. The maximum eccentricity is smaller than or equal to the lead diameter of the product concerned.

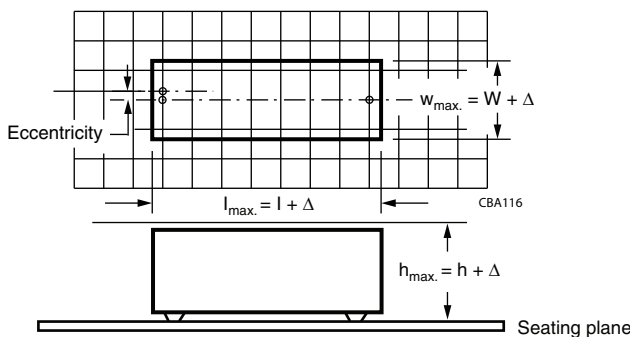

**SOLDERING CONDITIONS**

For general soldering conditions and wave soldering profile, we refer to the application note: "Soldering Guidelines for Film Capacitors": [www.vishay.com/doc?28171](http://www.vishay.com/doc?28171)

**Storage Temperature**

T<sub>stg</sub> = -25 °C to +35 °C with RH maximum 75 % without condensation

**Ratings and Characteristics Reference Conditions**

Unless otherwise specified, all electrical values apply to an ambient temperature of 23 °C ± 1 °C, an atmospheric pressure of 86 kPa to 106 kPa and a relative humidity of 50 % ± 2 %.

For reference testing, a conditioning period shall be applied over 96 h ± 4 h by heating the products in a circulating air oven at the rated temperature and a relative humidity not exceeding 20 %.



**CHARACTERISTICS**

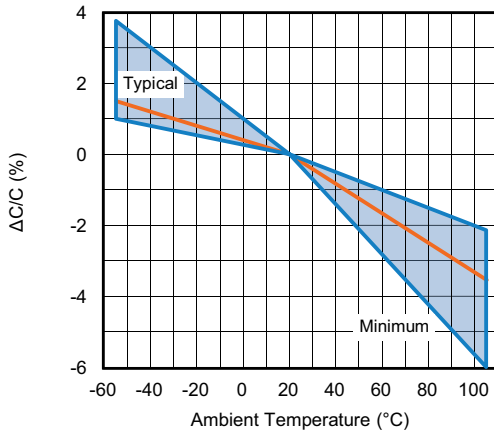

Capacitance as a function of ambient temperature (typical curve)

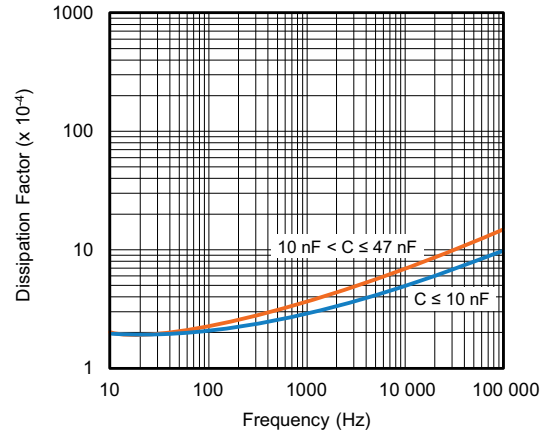

Tangent of loss angle as a function of frequency (typical curve)

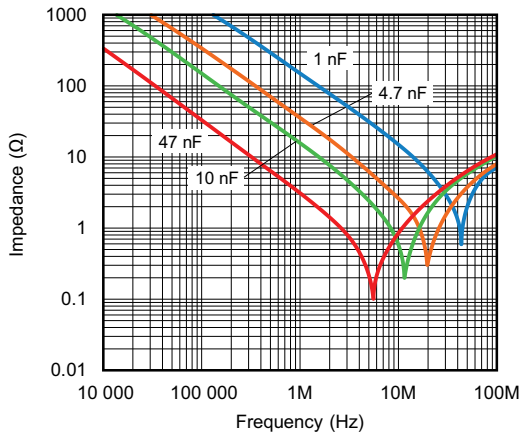

Impedance as a function of frequency (typical curve)

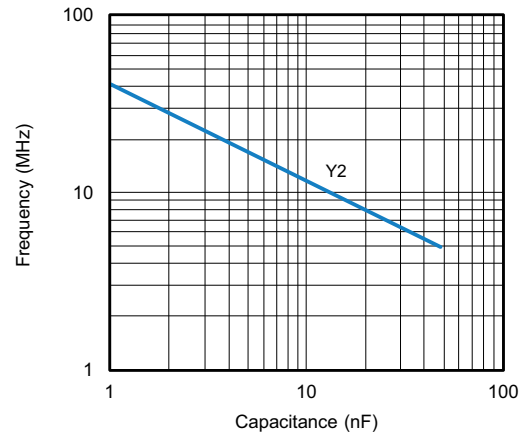

Resonant frequency as a function of capacitance (typical curve)

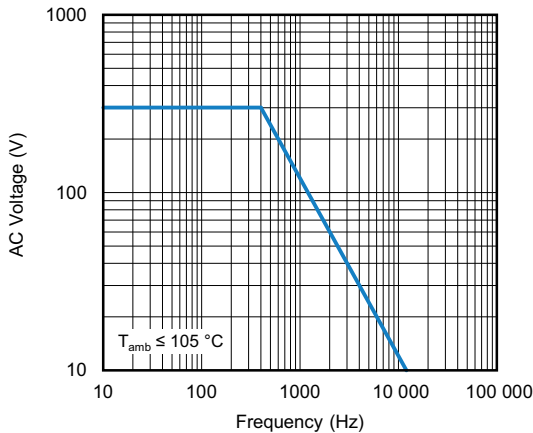

Max. RMS voltage as a function of frequency

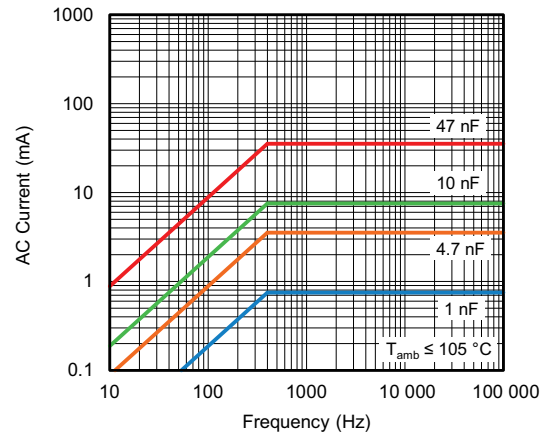

Max. RMS current as a function of frequency

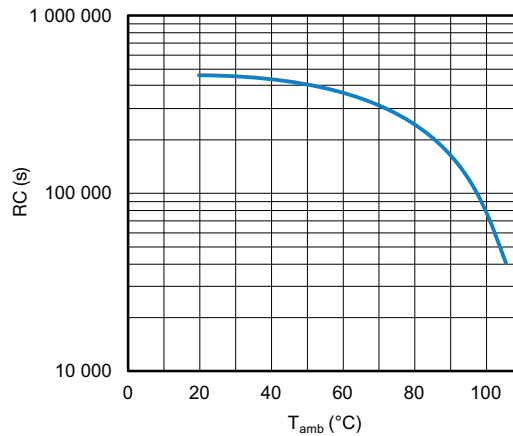

Insulation resistance as a function of ambient temperature  
(typical curve)

**APPLICATION NOTES**

- For Y2 electromagnetic interference suppression between line and ground (50 Hz / 60 Hz) with a maximum mains voltage of 300 V<sub>AC</sub> ± 10 % instability
- For capacitors connected in parallel, normally the proof voltage and possibly the rated voltage must be reduced. For information depending of the capacitance value and the number of parallel connections contact: [rfi@vishay.com](mailto:rfi@vishay.com)
- These capacitors are not intended for continuous pulse applications. For these situations, capacitors of the AC and pulse program must be used
- The maximum ambient temperature must not exceed 105 °C
- Rated voltage pulse slope:  
if the pulse voltage is lower than the rated voltage, the values of the specific reference data can be multiplied by 420 V<sub>DC</sub> and divided by the applied voltage



**INSPECTION REQUIREMENTS**

**General Notes**

Sub-clause numbers of tests and performance requirements refer to the “Sectional Specification, Publication IEC 60384-14 ed-4 (2013) and Specific Reference Data.”

<b>GROUP C INSPECTION REQUIREMENTS</b>		
<b>SUB-CLAUSE NUMBER AND TEST</b>	<b>CONDITIONS</b>	<b>PERFORMANCE REQUIREMENTS</b>
<b>SUB-GROUP C1A PART OF SAMPLE OF SUB-GROUP C1</b>		
4.1 Dimensions (detail)		As specified in chapters “General data” of this specification
Initial measurements	Capacitance Tangent of loss angle at 10 kHz	
4.3 Robustness of terminations	Tensile: load 10 N; 10 s Bending: load 5 N; 4 x 90°	No visible damage
4.4 Resistance to soldering heat	No pre-drying Method: 1A Solder bath: 260 °C Duration: 10 s	
4.19 Component solvent resistance	Isopropylalcohol at room temperature Method: 2 Immersion time: 5 min ± 0.5 min Recovery time: Min. 1 h, max. 2 h	
4.4.2 Final measurements	Visual examination	No visible damage Legible marking
	Capacitance	$ \Delta C/C  \leq 5\%$ of the value measured initially
	Tangent of loss angle	Increase of $\tan \delta: \leq 0.008$ Compared to values measured initially
	Insulation resistance	As specified in section “Insulation Resistance” of this specification
<b>SUB-GROUP C1B PART OF SAMPLE OF SUB-GROUP C1</b>		
Initial measurements	Capacitance Tangent of loss angle at 10 kHz	
4.20 Solvent resistance of the marking	Isopropylalcohol at room temperature Method: 1 Rubbing material: cotton wool Immersion time: 5 min ± 0.5 min	No visible damage Legible marking
4.6 Rapid change of temperature	$\theta A = - 55\text{ °C}$ $\theta B = + 105\text{ °C}$ 5 cycles	
4.6.1 Inspection	Duration $t = 30\text{ min}$	



<b>GROUP C INSPECTION REQUIREMENTS</b>		
<b>SUB-CLAUSE NUMBER AND TEST</b>	<b>CONDITIONS</b>	<b>PERFORMANCE REQUIREMENTS</b>
<b>SUB-GROUP C1B PART OF SAMPLE OF SUB-GROUP C1</b>		
4.7 Vibration	Visual examination Mounting: See section "Mounting" of this specification Procedure B4 Frequency range: 10 Hz to 55 Hz. Amplitude: 0.75 mm or Acceleration 98 m/s <sup>2</sup> (whichever is less severe) Total duration 6 h	No visible damage
4.7.2 Final inspection	Visual examination	No visible damage
4.9 Shock	Mounting: see section "Mounting" for more information Pulse shape: half sine Acceleration: 490 m/s <sup>2</sup> Duration of pulse: 11 ms	
4.9.2 Final measurements	Visual examination  Capacitance  Tangent of loss angle  Insulation resistance	No visible damage  $ \Delta C/C  \leq 5\%$ of the value measured initially  Increase of tan $\delta$ : $\leq 0.008$ Compared to values measured initially  As specified in section "Insulation Resistance" of this specification
<b>SUB-GROUP C1 COMBINED SAMPLE OF SPECIMENS OF SUB-GROUPS C1A AND C1B</b>		
4.11 Climatic sequence		
4.11.1 Initial measurements	Capacitance Measured in 4.4.2 and 4.9.2 Tangent of loss angle: Measured initially in C1A and C1B	
4.11.2 Dry heat	Temperature: 105 °C Duration: 16 h	
4.11.3 Damp heat cyclic Test Db First cycle		
4.11.4 Cold	Temperature: - 55 °C Duration: 2 h	
4.11.5 Damp heat cyclic Test Db remaining cycles		



<b>GROUP C INSPECTION REQUIREMENTS</b>		
<b>SUB-CLAUSE NUMBER AND TEST</b>	<b>CONDITIONS</b>	<b>PERFORMANCE REQUIREMENTS</b>
<b>SUB-GROUP C1 COMBINED SAMPLE OF SPECIMENS OF SUB-GROUPS C1A AND C1B</b>		
4.11.6 Final measurements	Visual examination  Capacitance  Tangent of loss angle  Voltage proof 2250 V <sub>DC</sub> ; 1 min between term.  Insulation resistance	No visible damage Legible marking  $ \Delta C/C  \leq 5\%$ of the value measured in 4.11.1.  Increase of tan $\delta$ : $\leq 0.008$ Compared to values measured in 4.11.1.  No permanent breakdown or flash-over  $\geq 50\%$ of values specified in section "Insulation resistance" of this specification
<b>SUB-GROUP C2</b>		
4.12 Damp heat steady state	56 days, 40 °C, 90 % to 95 % RH no load capacitance	
4.12.1 Initial measurements	Capacitance Tangent of loss angle at 10 kHz	
4.12.3 Final measurements	Visual examination  Capacitance  Tangent of loss angle  Voltage proof 2250 V <sub>DC</sub> ; 1 min between term.  Insulation resistance	No visible damage Legible marking  $ \Delta C/C  \leq 5\%$ of the value measured in 4.12.1.  Increase of tan $\delta$ : $\leq 0.007$ Compared to values measured in 4.12.1.  No permanent breakdown or flash-over  $\geq 50\%$ of values specified in section "Insulation resistance" of this specification
<b>SUB-GROUP C3</b>		
4.13.1 Initial measurements	Capacitance Tangent of loss angle at 10 kHz	
4.13 Impulse voltage	3 successive impulses, full wave, peak voltage: 5 kV Max. 24 pulses	No selfhealing breakdowns or flashover
4.14 Endurance	Duration: 1000 h 1.7 U <sub>RAC</sub> at 105 °C Once in every hour the voltage is increased to 1000 V <sub>RMS</sub> for 0.1 s via resistor of 47 $\Omega \pm 5\%$	

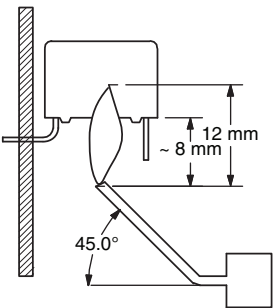

<b>GROUP C INSPECTION REQUIREMENTS</b>		
<b>SUB-CLAUSE NUMBER AND TEST</b>	<b>CONDITIONS</b>	<b>PERFORMANCE REQUIREMENTS</b>
<b>SUB-GROUP C3</b>		
4.14.7 Final measurements	Visual examination  Capacitance  Tangent of loss angle  Voltage proof 2250 V <sub>DC</sub> ; 1 min between terminations  Insulation resistance	No visible damage Legible marking  $ \Delta C/C  \leq 10\%$ compared to values measured in 4.13.1.  Increase of tan $\delta$ : $\leq 0.007$ Compared to values measured in 4.13.1.  No permanent breakdown or flash-over  $\geq 50\%$ of values specified in section "Insulation resistance" of this specification
<b>SUB-GROUP C4</b>		
4.15 Charge and discharge	10 000 cycles (50 c/s) charge to U <sub>R</sub> half sinewave Duration: 5 ms Discharge resistance: $R = \frac{420 V_{DC}}{1.5 \times C((dU)/(dt))}$ $R_{min.} = 2.2 \Omega$	
4.15.1 Initial measurements	Capacitance Tangent of loss angle at 10 kHz	
4.15.3 Final measurements	Capacitance  Tangent of loss angle  Insulation resistance	$ \Delta C/C  \leq 10\%$ compared to values measured in 4.15.1.  Increase of tan $\delta$ : $\leq 0.008$ Compared to values measured in 4.15.1.  $\geq 50\%$ of values specified in section "Insulation resistance" of this specification
<b>SUB-GROUP C5</b>		
4.16 Radio frequency characteristic	Resonance frequency	As specified in section "Resonant frequency" of this specification. $\pm 10\%$
<b>SUB-GROUP C6</b>		
4.17 Passive flammability Class B	Bore of gas jet: $\varnothing 0.5$ mm Fuel: Butane Test duration for actual volume V in mm <sup>3</sup> : V $\leq$ 250: 10 s 250 < V $\leq$ 500: 20 s 500 < V $\leq$ 1750: 30 s V > 1750: 60 s One flame application  	After removing test flame from capacitor, the capacitor must not continue to burn for more than 10 s. No burning particle must drop from the sample.



<b>GROUP C INSPECTION REQUIREMENTS</b>		
<b>SUB-CLAUSE NUMBER AND TEST</b>	<b>CONDITIONS</b>	<b>PERFORMANCE REQUIREMENTS</b>
<b>SUB-GROUP C7</b>		
4.18 Active flammability	20 x 5 kV discharges on the test capacitor connected to $U_R$	The cheese cloth around the capacitors shall not burn with a flame. No electrical measurements are required.
<b>SUB-GROUP ADD6 (FOR PITCH <math>\geq 15</math> mm)</b>		
A.6 Damp heat steady state with load	RH: 85 %, temp.: 85 °C Load: 300 V <sub>AC</sub> , duration: 500 h	
A.6.1 Initial measurements	Capacitance  Tangent of loss angle: at 10 kHz	
A.6.2 Final measurements	Visual examination  Capacitance  Tangent of loss angle  Insulation resistance	No visible damage Legible marking  $ \Delta C/C  \leq 10$ % of the value measured in A.6.1  Increase of $\tan \delta \leq 0.024$ Compared to values measured in A.6.1 No permanent breakdown or flash-over  $\geq 50$ % of values specified in section "Insulation Resistance" of this specification
<b>SUB-GROUP ADD7</b>		
A.7 Damp heat steady state with load	RH: 40 %, temp.: 93 °C; Load: 300 V <sub>AC</sub> , duration: 21 days	
A.7.1 Initial measurements	Capacitance  Tangent of loss angle: at 10 kHz	
A.7.2 Final measurements	Visual examination  Capacitance  Tangent of loss angle  Insulation resistance	No visible damage Legible marking  $ \Delta C/C  \leq 10$ % of the value measured in A.7.1  Increase of $\tan \delta \leq 0.024$ Compared to values measured in A.7.1 No permanent breakdown or flash-over  $\geq 50$ % of values specified in section "Insulation Resistance" of this specification



## Disclaimer

ALL PRODUCT, PRODUCT SPECIFICATIONS AND DATA ARE SUBJECT TO CHANGE WITHOUT NOTICE TO IMPROVE RELIABILITY, FUNCTION OR DESIGN OR OTHERWISE.

Vishay Intertechnology, Inc., its affiliates, agents, and employees, and all persons acting on its or their behalf (collectively, "Vishay"), disclaim any and all liability for any errors, inaccuracies or incompleteness contained in any datasheet or in any other disclosure relating to any product.

Vishay makes no warranty, representation or guarantee regarding the suitability of the products for any particular purpose or the continuing production of any product. To the maximum extent permitted by applicable law, Vishay disclaims (i) any and all liability arising out of the application or use of any product, (ii) any and all liability, including without limitation special, consequential or incidental damages, and (iii) any and all implied warranties, including warranties of fitness for particular purpose, non-infringement and merchantability.

Statements regarding the suitability of products for certain types of applications are based on Vishay's knowledge of typical requirements that are often placed on Vishay products in generic applications. Such statements are not binding statements about the suitability of products for a particular application. It is the customer's responsibility to validate that a particular product with the properties described in the product specification is suitable for use in a particular application. Parameters provided in datasheets and / or specifications may vary in different applications and performance may vary over time. All operating parameters, including typical parameters, must be validated for each customer application by the customer's technical experts. Product specifications do not expand or otherwise modify Vishay's terms and conditions of purchase, including but not limited to the warranty expressed therein.

Hyperlinks included in this datasheet may direct users to third-party websites. These links are provided as a convenience and for informational purposes only. Inclusion of these hyperlinks does not constitute an endorsement or an approval by Vishay of any of the products, services or opinions of the corporation, organization or individual associated with the third-party website. Vishay disclaims any and all liability and bears no responsibility for the accuracy, legality or content of the third-party website or for that of subsequent links.

Except as expressly indicated in writing, Vishay products are not designed for use in medical, life-saving, or life-sustaining applications or for any other application in which the failure of the Vishay product could result in personal injury or death. Customers using or selling Vishay products not expressly indicated for use in such applications do so at their own risk. Please contact authorized Vishay personnel to obtain written terms and conditions regarding products designed for such applications.

No license, express or implied, by estoppel or otherwise, to any intellectual property rights is granted by this document or by any conduct of Vishay. Product names and markings noted herein may be trademarks of their respective owners.

## Looking for pricing, stock, or lifecycle information?

Click below to explore more details on WIN SOURCE:

 [View BFC233660222 on WIN SOURCE](#)

 [Vishay Information](#)

## Optimize Your Supply Chain with WIN SOURCE Solutions

-  Global Sourcing Solution
-  Obsolete Management
-  Cost Control Management
-  Shortage Management
-  Alternative Solution
-  Excess Inventory Management