



**THE DATASHEET OF
B32716H6506K000**



Film Capacitor

Metallized polypropylene Film Capacitor

Series/Type: B32714H ... B32718H

Date: July 2022

Film Capacitor

Metallized polypropylene Film Capacitor

B32714H ... B32718H

Typical applications

- Frequency converters
- Industrial and high-end power supplies
- Solar inverters

Climatic

- Max. operating temperature: 105 °C (case)
- Climatic category (IEC 60068-1: 55/105/56 40/105/56)

Construction

- Dielectric: polypropylene (MKP)
- Plastic case (UL 94 V-0)
- Epoxy resin sealing (UL 94 V-0)

Features

- Capacitance values up 0.47 μF to 170 μF
- High CV product, compact
- Good self-healing properties
- Over-voltage capability
- Low losses with high current capability
- High reliability
- Long useful life
- RoHS-compatible
- UL 810 construction
- AEC-Q200D compliant

Terminals

- Parallel wire leads, lead-free tinned
- 2-pin, 4-pin
- Standard lead lengths: 6 –1 mm

Marking

- Manufacturer's logo and lot number, date code, rated capacitance (coded), capacitance tolerance (code letter) and rated DC voltage

Delivery mode

- Bulk (untaped)

Approval

Approval mark	Standards	Certificate
	UL 810 (construction only)	E323128

Film Capacitor
Metallized polypropylene Film Capacitor
B32714H ... B32718H
Dimensional drawings

Number of wires	Lead spacing $e \pm 0.4$	Lead diameter $d_1 \pm 0.05$	Type
2-pin	27.5	0.8	B32714H
2-pin	37.5	1.0	B32716H
4-pin	37.5	1.2	B32716H
4-pin	52.5	1.2	B32718H

Dimensions in mm

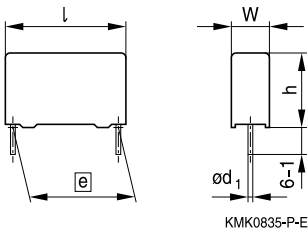
Dimensional drawings 2-pin versions
B32714H, B32716H

	B32714H	B32716H
Lead spacing $e \pm 0.4$:	27.5	37.5
Lead diameter d_1 :	0.8	1.0

Dimensions in mm

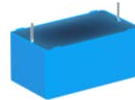
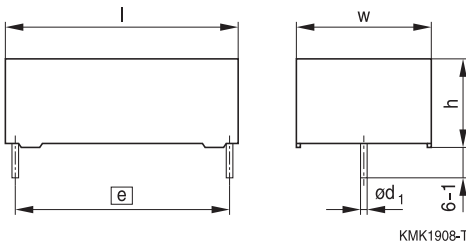
B32716H (low profile)

Lead spacing $e \pm 0.4$:	37.5
Lead diameter d_1 :	1.0

Dimensions in mm

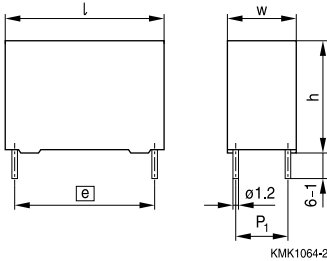
Film Capacitor
Metallized polypropylene Film Capacitor
B32714H ... B32718H
Dimensional drawings 4-pin versions
B32716H, B32718H

	B32716H	B32718H
Lead spacing $e \pm 0.4$:	37.5	52.5
Lead diameter d_1 :	1.2	1.2

Dimensions in mm

Film Capacitor
Metallized polypropylene Film Capacitor
B32714H ... B32718H
Overview of available types

Lead spacing	27.5 mm									
Type	B32714H									
V_R (85 °C)	500	600	800	900	1000	1100	1200	1400	1500	1600
C_R (μF)										
0.47										
0.56										
0.68										
0.82										
1.0										
1.5										
2.0										
2.2										
2.5										
3.0										
3.3										
4.0										
5.0										
6.0										
7.0										
8.0										
9.0										
10										
12										
14										
15										
16										
22										

Film Capacitor
Metallized polypropylene Film Capacitor
B32714H ... B32718H
Overview of available types

Lead spacing	37.5 mm									
Type	B32716H									
V_R (85 °C)	500	600	800	900	1000	1100	1200	1400	1500	1600
C_R (μF)										
1.0										
1.5										
2.0										
2.7										
3.3										
3.5										
3.9										
4.0										
4.5										
5.0										
6.0										
6.8										
7.0										
7.5										
8.0										
8.5										
9										
10										
12										
14										
15										
16										
18										
20										
22										
25										
30										
35										
40										
45										
50										
60										
65										
85										
120										

Film Capacitor
Metallized polypropylene Film Capacitor
B32714H ... B32718H
Overview of available types

Lead spacing	52.5 mm									
Type	B32718H									
V_R (85 °C)	500	600	800	900	1000	1100	1200	1400	1500	1600
C_R (μF)										
8.0										
10										
12										
15										
18										
20										
22										
25										
27										
30										
33										
35										
40										
45										
47										
50										
55										
58										
60										
65										
70										
75										
80										
85										
90										
95										
100										
110										
120										
130										
140										
150										
170										

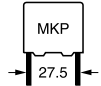
Film Capacitor
Metallized polypropylene Film Capacitor
B32714H ... B32718H
Ordering codes and packing units (lead spacing 27.5 mm)

$C_R^{1)}$	Max. dimensions w x h x l	P1	Ordering code (composition see below)	$I_{RMS,max}$ 70 °C 10 kHz A	$I_{RMS,max}^{2)}$ 85 °C 10 kHz A	ESR_{typ} 85 °C 10 kHz mΩ	$ESL_{typ}^{3)}$ nH	$\tan \delta$ max 1 kHz 10^{-3}	$\tan \delta$ max 10 kHz 10^{-3}	Pcs./ MOQ
μF	mm	mm		A	A	mΩ	nH	10^{-3}	10^{-3}	
$V_{R,85\text{ °C}} = 500\text{ V DC}$, $V_{op,100\text{ °C}} = 400\text{ V DC}$										
3.3	9.0x18.0x31.5	–	B32714H5335+000	4.5	3.9	16.0	12.0	0.8	6.6	2400
5.0	11.0x21.0x31.5	–	B32714H5505+000	6.3	5.5	10.8	14.0	0.8	6.8	2352
6.0	12.5x21.5x31.5	–	B32714H5605+000	7.0	6.1	9.2	15.0	0.8	6.9	2100
7.0	13.5x23.0x31.5	–	B32714H5705+000	7.8	6.8	8.1	16.0	0.9	7.1	1932
8.0	14.0x24.5x31.5	–	B32714H5805+000	8.6	7.5	7.2	17.0	0.9	7.2	1848
10.0	15.0x24.5x31.5	–	B32714H5106+000	9.5	8.3	6.1	18.0	0.9	7.7	1680
12.0	18.0x27.5x31.5	–	B32714H5126+000	11.4	9.9	5.2	19.0	0.9	7.8	1428
15.0	18.0x33.0x31.5	–	B32714H5156+000	12.8	11.1	4.5	21.0	0.9	8.5	952
16.0	21.0x31.0x31.5	–	B32714H5166+000	13.7	11.9	4.2	21.0	1.0	8.5	784
22.0	22.0x36.5x31.5	*)	B32714H5226+000	14.0	13.6	3.6	23.0	1.1	9.9	784
$V_{R,85\text{ °C}} = 600\text{ V DC}$, $V_{op,100\text{ °C}} = 480\text{ V DC}$										
2.2	9.0x18.0x31.5	–	B32714H6225+000	4.0	3.5	20.0	12.0	0.8	5.5	2400
4.0	11.0x21.0x31.5	–	B32714H6405+000	6.2	5.4	11.0	14.0	0.8	5.6	2352
5.0	13.5x23.0x31.5	–	B32714H6505+000	7.2	6.3	9.4	16.0	0.8	5.9	1932
6.0	14.0x24.5x31.5	–	B32714H6605+000	8.1	7.0	8.2	17.0	0.8	6.2	1848
7.0	15.0x24.5x31.5	–	B32714H6705+000	8.6	7.5	7.5	17.0	0.8	6.6	1680
8.0	18.0x27.5x31.5	–	B32714H6805+000	10.0	8.7	6.7	19.0	0.8	6.7	1428
9.0	18.0x27.5x31.5	–	B32714H6905+000	10.6	9.2	6.0	19.0	0.8	6.8	1428
10.0	18.0x33.0x31.5	–	B32714H6106+000	11.5	10.0	5.5	21.0	0.8	6.9	952
12.0	18.0x33.0x31.5	–	B32714H6126+000	12.5	10.9	4.7	21.0	0.9	7.1	952
15.0	22.0x36.5x31.5	*)	B32714H6156+000	14.0	13.0	4.0	23.0	0.9	7.5	784

MOQ = Minimum Order Quantity, consisting of 4 packing units.

Intermediate capacitance values are available on request.

*) 4-pin version available on request

Composition of ordering code

+ = Capacitance tolerance code:

 J = ±5%
 K = ±10%

*** = Packing code

 000 = untaped (lead length 6 – 1 mm)
 Other lead lengths available upon request

- 1) Capacitance value measured at 1 kHz.
- 2) Max ripple current I_{RMS} at 85 °C, 10 kHz for $\Delta T \leq 15\text{ °C}$, Capacitor body temperature (ambient temperature + self-heating) must be observed for maximum voltage rating. Refer to voltage derating rules in page 20.
- 3) Typical ESL value measured at resonance frequency (see specific graphs of Z versus frequency).

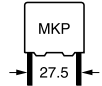
Film Capacitor
Metallized polypropylene Film Capacitor
B32714H ... B32718H
Ordering codes and packing units (lead spacing 27.5 mm)

$C_R^{1)}$	Max. dimensions w x h x l	P1	Ordering code (composition see below)	$I_{RMS,max}$ 70 °C 10 kHz A	$I_{RMS,max}^{2)}$ 85 °C 10 kHz A	ESR _{typ} 85 °C 10 kHz mΩ	ESL _{typ} ³⁾ nH	tan δ max 1 kHz 10 ⁻³	tan δ max 10 kHz 10 ⁻³	Pcs./ MOQ
μF	mm	mm								
$V_{R,85\text{ °C}} = 800\text{ V DC}, V_{op,100\text{ °C}} = 640\text{ V DC}$										
2.0	9.0x18.0x31.5	–	B32714H8205K000	3.9	3.4	20.8	12.0	0.8	5.2	2400
3.0	11.0x21.0x31.5	–	B32714H8305+000	5.6	4.9	13.5	14.0	0.8	5.2	2352
4.0	13.5x23.0x31.5	–	B32714H8405+000	6.9	6.0	10.3	16.0	0.8	5.3	1932
5.0	14.0x24.5x31.5	–	B32714H8505+000	7.8	6.8	8.8	17.0	0.8	5.5	1848
6.0	16.0x30.0x31.5	–	B32714H8605+000	8.9	7.7	7.4	20.0	0.8	5.6	1064
7.0	16.0x30.0x31.5	–	B32714H8705+000	9.5	8.3	6.4	20.0	0.8	5.7	1064
8.0	18.0x33.0x31.5	–	B32714H8805+000	10.9	9.5	6.1	21.0	0.8	6.1	952
9.0	18.0x33.0x31.5	–	B32714H8905+000	11.5	10.0	5.6	21.0	0.8	6.3	952
10.0	21.0x31.0x31.5	–	B32714H8106+000	12.2	10.6	5.2	21.0	0.8	6.6	784
12.0	22.0x36.5x31.5	*)	B32714H8126+000	13.8	12.0	4.7	23.0	0.9	7.1	784
14.0	22.0x36.5x31.5	*)	B32714H8146K000	14.0	12.5	4.4	23.0	0.9	7.5	784
$V_{R,85\text{ °C}} = 900\text{ V DC}, V_{op,100\text{ °C}} = 720\text{ V DC}$										
2.5	12.5x21.5x31.5	–	B32714H9255+000	5.8	5.0	14.0	15.0	0.8	4.4	2100
3.0	13.5x23.0x31.5	–	B32714H9305+000	6.2	5.4	12.6	16.0	0.8	4.7	1932
4.0	15.0x24.5x31.5	–	B32714H9405+000	7.6	6.6	9.5	17.0	0.8	4.8	1680
5.0	16.0x30.0x31.5	–	B32714H9505+000	8.6	7.5	7.8	20.0	0.8	4.9	1064
6.0	18.0x33.0x31.5	–	B32714H9605+000	10.5	9.1	6.7	21.0	0.8	5.1	952
7.0	21.0x31.0x31.5	–	B32714H9705+000	11.5	10.0	5.9	21.0	0.8	5.3	784
10.0	22.0x36.5x31.5	–	B32714H9106+000	14.0	12.2	4.5	23.0	0.8	5.7	784
$V_{R,85\text{ °C}} = 1000\text{ V DC}, V_{op,100\text{ °C}} = 800\text{ V DC}$										
2.0	12.5x21.5x31.5	–	B32714H0205+000	5.4	4.7	15.6	15.0	0.8	3.9	2100
3.0	15.0x24.5x31.5	–	B32714H0305+000	7.2	6.3	10.6	17.0	0.8	4.0	1680
4.0	16.0x30.0x31.5	–	B32714H0405+000	8.5	7.4	8.1	20.0	0.8	4.1	1064
5.0	18.0x33.0x31.5	–	B32714H0505+000	10.5	9.1	6.7	21.0	0.8	4.2	952
7.0	22.0x36.5x31.5	*)	B32714H0705+000	13.1	11.4	5.2	23.0	0.8	4.6	784
8.0	22.0x36.5x31.5	*)	B32714H0805+000	13.6	11.8	4.8	23.0	0.8	4.8	784

MOQ = Minimum Order Quantity, consisting of 4 packing units.

Intermediate capacitance values are available on request.

*) 4-pin version available on request

Composition of ordering code

+ = Capacitance tolerance code:

 J = ±5%
 K = ±10%

*** = Packing code

 000 = untaped (lead length 6 – 1 mm)
 Other lead lengths available upon request

- 1) Capacitance value measured at 1 kHz.
- 2) Max ripple current I_{RMS} at 85 °C, 10 kHz for $\Delta T \leq 15\text{ °C}$, Capacitor body temperature (ambient temperature + self-heating) must be observed for maximum voltage rating. Refer to voltage derating rules in page 20.
- 3) Typical ESL value measured at resonance frequency (see specific graphs of Z versus frequency).

Film Capacitor
Metallized polypropylene Film Capacitor
B32714H ... B32718H
Ordering codes and packing units (lead spacing 27.5 mm)

$C_R^{1)}$	Max. dimensions w x h x l	P1	Ordering code (composition see below)	$I_{RMS,max}$ 70 °C 10 kHz A	$I_{RMS,max}^{2)}$ 85 °C 10 kHz A	ESR_{typ} 85 °C 10 kHz mΩ	$ESL_{typ}^{3)}$ nH	$\tan \delta$ max 1 kHz 10^{-3}	$\tan \delta$ max 10 kHz 10^{-3}	Pcs./ MOQ
μF	mm	mm								
$V_{R,85\text{ °C}} = 1100\text{ V DC}$, $V_{op,100\text{ °C}} = 880\text{ V DC}$										
1.0	11.0x19.0x31.5	–	B32714H1105+000	3.7	3.2	27.0	12.0	0.8	3.4	2352
1.5	12.5x21.5x31.5	–	B32714H1155+000	4.9	4.3	18.6	15.0	0.8	3.5	2100
2.0	13.5x23.0x31.5	–	B32714H1205+000	5.9	5.1	14.1	16.0	0.8	3.6	1932
3.0	16.0x30.0x31.5	–	B32714H1305+000	7.7	6.7	9.7	20.0	0.8	3.7	1064
4.0	18.0x33.0x31.5	–	B32714H1405+000	9.9	8.6	7.5	21.0	0.8	3.8	952
5.0	21.0x31.0x31.5	–	B32714H1505+000	11.3	9.8	6.1	21.0	0.8	3.9	784
6.0	22.0x36.5x31.5	*)	B32714H1605+000	13.0	11.3	5.3	23.0	0.8	4.0	784
$V_{R,85\text{ °C}} = 1200\text{ V DC}$, $V_{op,100\text{ °C}} = 960\text{ V DC}$										
1.0	11.0x21.0x31.5	–	B32714H2105+000	4.1	3.6	24.7	15.0	0.8	3.3	2352
1.5	12.5x21.5x31.5	–	B32714H2155K000	5.1	4.4	17.7	15.0	0.8	3.4	2100
2.0	15.0x24.5x31.5	–	B32714H2205+000	6.6	5.7	12.9	17.0	0.8	3.4	1680
3.0	16.0x30.0x31.5	–	B32714H2305K000	8.2	7.1	8.7	20.0	0.8	3.5	1064
4.0	18.0x33.0x31.5	–	B32714H2405K000	10.4	9.0	6.8	21.0	0.8	3.5	952
5.0	22.0x36.5x31.5	*)	B32714H2505+000	12.7	11.0	5.5	23.0	0.8	3.6	784
$V_{R,85\text{ °C}} = 1400\text{ V DC}$, $V_{op,100\text{ °C}} = 1120\text{ V DC}$										
0.56	11.0x19.0x31.5	–	B32714H4564+000	3.3	2.9	33.0	13.0	0.8	2.4	2352
0.68	11.0x21.0x31.5	–	B32714H4684+000	3.9	3.4	27.7	15.0	0.8	2.4	2352
1.0	12.5x21.5x31.5	–	B32714H4105K000	4.8	4.2	19.9	15.0	0.8	2.5	2100
1.5	15.0x24.5x31.5	–	B32714H4155K000	6.3	5.5	13.6	17.0	0.8	2.6	1680
2.0	18.0x27.5x31.5	–	B32714H4205+000	8.2	7.1	10.2	19.0	0.8	2.7	1428
3.0	22.0x36.5x31.5	*)	B32714H4305+000	11.2	9.7	7.1	23.0	0.8	2.8	784
4.0	22.0x36.5x31.5	*)	B32714H4405K000	12.3	10.7	5.8	23.0	0.8	3.0	784

MOQ = Minimum Order Quantity, consisting of 4 packing units.

Intermediate capacitance values are available on request.

*) 4-pin version available on request

Composition of ordering code

+ = Capacitance tolerance code:

 J = ±5%
 K = ±10%

*** = Packing code

 000 = untaped (lead length 6 – 1 mm)
 Other lead lengths available upon request

- 1) Capacitance value measured at 1 kHz.
- 2) Max ripple current I_{RMS} at 85 °C, 10 kHz for $\Delta T \leq 15\text{ °C}$, Capacitor body temperature (ambient temperature + self-heating) must be observed for maximum voltage rating. Refer to voltage derating rules in page 20.
- 3) Typical ESL value measured at resonance frequency (see specific graphs of Z versus frequency).

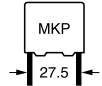
Film Capacitor
Metallized polypropylene Film Capacitor
B32714H ... B32718H
Ordering codes and packing units (lead spacing 27.5 mm)

C_R ¹⁾	Max. dimensions w x h x l	P1	Ordering code (composition see below)	$I_{RMS,max}$ 70 °C 10 kHz A	$I_{RMS,max}$ ²⁾ 85 °C 10 kHz A	ESR_{typ} 85 °C 10 kHz mΩ	ESL_{typ} ³⁾ nH	$\tan \delta$ max 1 kHz 10 ⁻³	$\tan \delta$ max 10 kHz 10 ⁻³	Pcs./ MOQ
μF	mm	mm								
$V_{R,85\text{ °C}} = 1500\text{ V DC}$, $V_{op,100\text{ °C}} = 1200\text{ V DC}$										
0.47	11.0x19.0x31.5	–	B32714H7474+000	3.2	2.8	35.0	13.0	0.8	2.2	2352
0.68	12.5x21.5x31.5	–	B32714H7684+000	4.3	3.7	25.0	14.0	0.8	2.2	2100
1.0	15.0x24.5x31.5	–	B32714H7105+000	5.6	4.9	17.3	17.0	0.8	2.2	1680
1.5	18.0x27.5x31.5	–	B32714H7155+000	7.5	6.5	11.9	19.0	0.8	2.3	1428
2.0	21.0x31.0x31.5	–	B32714H7205+000	9.3	8.1	9.0	21.0	0.8	2.3	784
3.0	22.0x36.5x31.5	*)	B32714H7305K000	11.7	10.2	6.5	23.0	0.8	2.5	784
$V_{R,85\text{ °C}} = 1600\text{ V DC}$, $V_{op,100\text{ °C}} = 1280\text{ V DC}$										
0.47	11.0x21.0x31.5	–	B32714H3474+000	3.8	3.3	30.0	13.0	0.8	2.0	2352
0.56	12.5x21.5x31.5	–	B32714H3564+000	4.1	3.6	27.0	14.0	0.8	2.0	2100
0.68	14.0x24.5x31.5	–	B32714H3684+000	4.9	4.3	22.3	17.0	0.8	2.1	1848
0.82	15.0x24.5x31.5	–	B32714H3824+000	5.4	4.7	19.0	17.0	0.8	2.1	1680
1.0	18.0x27.5x31.5	–	B32714H3105+000	6.6	5.7	15.8	19.0	0.8	2.2	1428
1.5	18.0x33.0x31.5	–	B32714H3155+000	8.2	7.1	11.0	21.0	0.8	2.2	952
2.0	22.0x36.5x31.5	*)	B32714H3205+000	10.2	8.9	8.5	23.0	0.8	2.2	784

MOQ = Minimum Order Quantity, consisting of 4 packing units.

Intermediate capacitance values are available on request.

*) 4-pin version available on request

Composition of ordering code

+= Capacitance tolerance code:

 J = ±5%
 K = ±10%

*** = Packing code

 000 = untaped (lead length 6 – 1 mm)
 Other lead lengths available upon request

- 1) Capacitance value measured at 1 kHz.
- 2) Max ripple current I_{RMS} at 85 °C, 10 kHz for $\Delta T \leq 15\text{ °C}$, Capacitor body temperature (ambient temperature + self-heating) must be observed for maximum voltage rating. Refer to voltage derating rules in page 20.
- 3) Typical ESL value measured at resonance frequency (see specific graphs of Z versus frequency).

Film Capacitor
Metallized polypropylene Film Capacitor
B32714H ... B32718H
Ordering codes and packing units (lead spacing 37.5 mm)

$C_R^{1)}$	Max. dimensions w x h x l	P1	Ordering code (composition see below)	$I_{RMS,max}$ 70 °C 10 kHz A	$I_{RMS,max}^{2)}$ 85 °C 10 kHz A	ESR_{typ} 85 °C 10 kHz mΩ	$ESL_{typ}^{3)}$ nH	$\tan \delta$ max 1 kHz 10^{-3}	$\tan \delta$ max 10 kHz 10^{-3}	Pcs./ MOQ
μF	mm	mm								
$V_{R,85\text{ °C}} = 500\text{ V DC}$, $V_{op,100\text{ °C}} = 400\text{ V DC}$										
12.0	24.0x15.0x42.0	—	B32716H5126K000	8.2	7.1	10.0	12.0	1.5	13.9	1040
16.0	24.0x19.0x42.0	—	B32716H5166K000	9.5	8.3	7.5	13.0	1.6	13.9	780
30.0	20.0x39.5x42.0	10.2	B32716H5306+000	16.0	13.9	4.3	13.0	1.6	15.0	640
35.0	28.0x37.0x42.0	10.2	B32716H5356+000	18.3	15.9	3.8	14.0	1.7	15.5	440
40.0	28.0x37.0x42.0	10.2	B32716H5406+000	19.6	17.0	3.3	13.0	1.7	15.6	440
50.0	28.0x42.5x42.0	10.2	B32716H5506+000	22.2	19.3	2.8	14.0	1.8	16.2	440
60.0	30.0x45.0x42.0	20.3	B32716H5606+000	25.3	22.0	2.4	15.0	1.8	16.6	400
65.0	33.0x48.0x42.0	20.3	B32716H5656+000	27.5	24.0	2.2	16.5	1.8	16.7	180
120.0	42.5x60.0x42.5	20.3	B32716H5127K000	35.0	31.0	1.8	19.0	2.7	25.1	140
$V_{R,85\text{ °C}} = 600\text{ V DC}$, $V_{op,100\text{ °C}} = 480\text{ V DC}$										
8.5	24.0x15.0x42.0	—	B32716H6855+000	7.6	6.6	11.6	12.0	1.3	11.5	1040
12.0	24.0x19.0x42.0	—	B32716H6126K000	9.3	8.1	8.5	13.0	1.3	11.9	780
25.0	20.0x39.5x42.0	10.2	B32716H6256K000	15.6	13.6	4.5	13.0	1.4	12.1	640
30.0	28.0x37.0x42.0	10.2	B32716H6306+000	19.3	16.8	3.4	14.0	1.4	11.9	440
35.0	28.0x42.5x42.0	10.2	B32716H6356+000	21.9	19.0	2.9	14.5	1.4	12.0	440
45.0	30.0x45.0x42.0	20.3	B32716H6456K000	24.2	21.0	2.6	15.5	1.5	13.6	400
50.0	33.0x48.0x42.0	20.3	B32716H6506+000	26.5	23.0	2.4	17.0	1.5	14.0	180
85.0	42.5x60.0x42.5	20.3	B32716H6856K000	34.0	30.0	1.9	18.0	1.9	18.8	140

MOQ = Minimum Order Quantity, consisting of 4 packing units.

Intermediate capacitance values are available on request.

*) 4-pin version available on request

Composition of ordering code

+= Capacitance tolerance code:

*** = Packing code

J = ±5%

000 = untaped (lead length 6–1 mm)

K = ±10%

Other lead lengths available upon request

- 1) Capacitance value measured at 1 kHz.
- 2) Max ripple current I_{RMS} at 85 °C, 10 kHz for $\Delta T \leq 15\text{ °C}$, Capacitor body temperature (ambient temperature + self-heating) must be observed for maximum voltage rating. Refer to voltage derating rules in page 20.
- 3) Typical ESL value measured at resonance frequency (see specific graphs of Z versus frequency).

Film Capacitor
Metallized polypropylene Film Capacitor
B32714H ... B32718H
Ordering codes and packing units (lead spacing 37.5 mm)

C _R ¹⁾	Max. dimensions w x h x l	P1	Ordering code (composition see below)	I _{RMS,max} 70 °C	I _{RMS,max} ²⁾ 85 °C	ESR _{typ} 85 °C	ESL _{typ} ³⁾	tan δ max	tan δ max	Pcs./ MOQ
	μF			mm	mm	10 kHz	10 kHz	10 kHz	nH	
V _{R,85 °C} = 800 V DC, V _{op,100 °C} = 640 V DC										
6.8	24.0x15.0x42.0	–	B32716H8685+000	7.4	6.4	12.3	12.0	1.1	9.7	1040
8.5	24.0x19.0x42.0	–	B32716H8855+000	8.5	7.4	10.0	13.0	1.1	9.9	780
14.0	18.0x32.5x42.0	–	B32716H8146K000	11.8	10.3	6.4	20.0	1.2	10.4	720
15.0	20.0x39.5x42.0	10.2	B32716H8156+000	13.8	12.0	5.8	13.0	1.2	10.1	640
20.0	28.0x37.0x42.0	10.2	B32716H8206+000	16.1	14.0	4.8	14.0	1.2	11.2	440
22.0	28.0x37.0x42.0	10.2	B32716H8226+000	16.9	14.7	4.4	14.0	1.3	11.3	440
25.0	28.0x42.5x42.0	10.2	B32716H8256+000	18.7	16.3	3.9	15.0	1.3	11.4	440
30.0	30.0x45.0x42.0	20.3	B32716H8306+000	21.5	18.7	3.3	15.5	1.3	11.5	400
35.0	33.0x48.0x42.0	20.3	B32716H8356+000	24.2	21.0	2.9	16.5	1.3	11.8	180
65.0	42.5x60.0x42.5	20.3	B32716H8656K000	33.0	28.8	2.1	18.5	1.7	15.9	140
V _{R,85 °C} = 900 V DC, V _{op,100 °C} = 720 V DC										
5.0	24.0x15.0x42.0	–	B32716H9505+000	6.7	5.8	15.0	12.0	1.0	8.8	1040
7.5	24.0x19.0x42.0	–	B32716H9755K000	8.4	7.3	10.5	13.0	1.1	9.2	780
15.0	20.0x39.5x42.0	10.2	B32716H9156K000	14.0	12.2	5.6	12.5	1.1	9.8	640
18.0	28.0x37.0x42.0	10.2	B32716H9186+000	16.2	14.1	4.8	13.5	1.2	10.0	440
20.0	28.0x37.0x42.0	10.2	B32716H9206K000	17.3	15.0	4.3	14.0	1.1	10.0	440
22.0	28.0x42.5x42.0	10.2	B32716H9226K000	19.0	16.5	3.8	15.0	1.1	9.8	440
25.0	30.0x45.0x42.0	20.3	B32716H9256+000	21.2	18.4	3.4	16.0	1.2	9.9	400
30.0	33.0x48.0x42.0	20.3	B32716H9306+000	24.2	21.0	2.9	17.0	1.2	10.1	180
50.0	42.5x60.0x42.5	20.3	B32716H9506+000	32.0	28.0	2.2	19.0	1.4	12.8	140

MOQ = Minimum Order Quantity, consisting of 4 packing units.

Intermediate capacitance values are available on request.

*) 4-pin version available on request

Composition of ordering code

+= Capacitance tolerance code:

 J = ±5%
 K = ±10%

*** = Packing code

 000 = untaped (lead length 6–1 mm)
 Other lead lengths available upon request

- 1) Capacitance value measured at 1 kHz.
- 2) Max ripple current I_{RMS} at 85 °C, 10 kHz for ΔT ≤ 15 °C, Capacitor body temperature (ambient temperature + self-heating) must be observed for maximum voltage rating. Refer to voltage derating rules in page 20.
- 3) Typical ESL value measured at resonance frequency (see specific graphs of Z versus frequency).

Film Capacitor
Metallized polypropylene Film Capacitor
B32714H ... B32718H
Ordering codes and packing units (lead spacing 37.5 mm)

C _R ¹⁾	Max. dimensions w x h x l	P1 mm	Ordering code (composition see below)	I _{RMS,max} 70 °C	I _{RMS,max} ²⁾ 85 °C	ESR _{typ} 85 °C	ESL _{typ} ³⁾	tan δ max	tan δ max	Pcs./ MOQ
	μF			mm	10 kHz	10 kHz	10 kHz	nH	1 kHz	
V _{R,85 °C} = 1000 V DC, V _{op,100 °C} = 800 V DC										
3.9	24.0x15.0x42.0	—	B32716H0395+000	6.3	5.5	17.0	11.5	0.9	7.7	1040
5.0	24.0x19.0x42.0	—	B32716H0505+000	7.4	6.4	13.5	13.0	0.9	7.9	780
12.0	20.0x39.5x42.0	10.2	B32716H0126K000	14.1	12.3	6.3	13.5	1.0	8.7	640
14.0	28.0x37.0x42.0	10.2	B32716H0146+000	15.5	13.5	5.3	14.0	1.0	8.7	440
15.0	24.0x44.0x42.0	12.7	B32716H0156+000	16.3	14.2	4.9	15.0	1.0	8.6	520
16.0	28.0x42.5x42.0	10.2	B32716H0166+000	17.3	15.0	4.6	15.5	1.0	8.6	440
20.0	30.0x45.0x42.0	20.3	B32716H0206+000	20.0	17.4	3.8	16.0	1.1	8.9	400
22.0	33.0x48.0x42.0	20.3	B32716H0226+000	22.2	19.3	3.4	17.0	1.1	8.9	180
40.0	42.5x60.0x42.5	20.3	B32716H0406+000	29.5	25.8	2.6	19.0	1.3	12.1	140
V _{R,85 °C} = 1100 V DC, V _{op,100 °C} = 880 V DC										
3.5	24.0x15.0x42.0	—	B32716H1355+000	6.2	5.4	17.5	12.0	0.9	7.2	1040
4.5	24.0x19.0x42.0	—	B32716H1455+000	7.2	6.3	14.0	13.0	0.9	7.4	780
8.0	20.0x39.5x42.0	10.2	B32716H1805+000	11.7	10.2	8.0	13.0	0.9	7.5	640
10.0	28.0x37.0x42.0	10.2	B32716H1106+000	13.9	12.1	6.5	14.0	0.9	7.6	440
12.0	24.0x44.0x42.0	12.7	B32716H1126+000	15.4	13.4	5.5	15.0	0.9	7.7	520
15.0	30.0x45.0x42.0	20.3	B32716H1156+000	18.4	16.0	4.5	16.0	0.9	7.9	400
16.0	30.0x45.0x42.0	20.3	B32716H1166+000	19.6	17.0	4.0	16.0	0.9	7.8	400
20.0	33.0x48.0x42.0	20.3	B32716H1206+000	22.2	19.3	3.4	17.5	0.9	8.0	180
30.0	42.5x60.0x42.5	20.3	B32716H1306+000	28.6	24.9	2.8	19.0	1.1	9.8	140

MOQ = Minimum Order Quantity, consisting of 4 packing units.

Intermediate capacitance values are available on request.

*) 4-pin version available on request

Composition of ordering code

+ = Capacitance tolerance code:

 J = ±5%
 K = ±10%

*** = Packing code

 000 = untaped (lead length 6 – 1 mm)
 Other lead lengths available upon request

- 1) Capacitance value measured at 1 kHz.
- 2) Max ripple current I_{RMS} at 85 °C, 10 kHz for ΔT ≤ 15 °C, Capacitor body temperature (ambient temperature + self-heating) must be observed for maximum voltage rating. Refer to voltage derating rules in page 20.
- 3) Typical ESL value measured at resonance frequency (see specific graphs of Z versus frequency).

Film Capacitor
Metallized polypropylene Film Capacitor
B32714H ... B32718H
Ordering codes and packing units (lead spacing 37.5 mm)

$C_R^{1)}$	Max. dimensions w x h x l	P1	Ordering code (composition see below)	$I_{RMS,max}$ 70 °C 10 kHz A	$I_{RMS,max}^{2)}$ 85 °C 10 kHz A	ESR_{typ} 85 °C 10 kHz mΩ	$ESL_{typ}^{3)}$ nH	$\tan \delta$ max 1 kHz 10^{-3}	$\tan \delta$ max 10 kHz 10^{-3}	Pcs./ MOQ
μF	mm	mm								
$V_{R,85\text{ °C}} = 1200\text{ V DC}$, $V_{op,100\text{ °C}} = 960\text{ V DC}$										
2.7	24.0x15.0x42.0	—	B32716H2275+000	6.0	5.2	19.2	11.5	0.8	6.1	1040
3.5	24.0x19.0x42.0	—	B32716H2355+000	7.0	6.1	15.0	13.0	0.8	6.2	780
8.0	20.0x39.5x42.0	10.2	B32716H2805+000	12.3	10.7	7.3	13.0	0.8	6.8	640
10.0	28.0x37.0x42.0	10.2	B32716H2106+000	14.6	12.7	5.9	14.0	0.8	6.9	440
12.0	28.0x42.5x42.0	10.2	B32716H2126+000	16.4	14.3	5.1	15.0	0.9	7.2	440
14.0	30.0x45.0x42.0	20.3	B32716H2146+000	18.6	16.2	4.4	16.0	0.9	7.2	400
16.0	33.0x48.0x42.0	20.3	B32716H2166+000	20.7	18.0	3.9	17.0	0.9	7.3	180
25.0	42.5x60.0x42.5	20.3	B32716H2256+000	28.0	24.5	2.9	19.0	1.0	8.5	140
$V_{R,85\text{ °C}} = 1400\text{ V DC}$, $V_{op,100\text{ °C}} = 1120\text{ V DC}$										
2.0	24.0x15.0x42.0	—	B32716H4205+000	5.6	4.9	21.2	11.5	0.8	5.0	1040
2.7	24.0x19.0x42.0	—	B32716H4275+000	6.7	5.8	16.5	12.5	0.8	5.2	780
5.0	20.0x39.5x42.0	10.2	B32716H4505+000	10.8	9.4	9.4	13.0	0.8	5.5	640
7.0	28.0x37.0x42.0	10.2	B32716H4705+000	13.8	12.0	6.7	14.0	0.8	5.5	440
8.0	28.0x42.5x42.0	10.2	B32716H4805+000	15.2	13.2	6.0	15.0	0.8	5.6	440
10.0	30.0x45.0x42.0	20.3	B32716H4106+000	17.1	14.9	5.2	16.0	0.8	6.1	400
12.0	33.0x48.0x42.0	20.3	B32716H4126K000	19.9	17.3	4.3	17.0	0.8	6.1	180
20.0	42.5x60.0x42.5	20.3	B32716H4206K000	27.0	23.6	3.1	19.0	0.9	7.3	140

MOQ = Minimum Order Quantity, consisting of 4 packing units.

Intermediate capacitance values are available on request.

*) 4-pin version available on request

Composition of ordering code

+ = Capacitance tolerance code:

 J = ±5%
 K = ±10%

*** = Packing code

 000 = untaped (lead length 6 – 1 mm)
 Other lead lengths available upon request

- 1) Capacitance value measured at 1 kHz.
- 2) Max ripple current I_{RMS} at 85 °C, 10 kHz for $\Delta T \leq 15\text{ °C}$, Capacitor body temperature (ambient temperature + self-heating) must be observed for maximum voltage rating. Refer to voltage derating rules in page 20.
- 3) Typical ESL value measured at resonance frequency (see specific graphs of Z versus frequency).

Film Capacitor
Metallized polypropylene Film Capacitor
B32714H ... B32718H
Ordering codes and packing units (lead spacing 37.5 mm)

C _R ¹⁾	Max. dimensions w x h x l	P1	Ordering code (composition see below)	I _{RMS,max} 70 °C	I _{RMS,max} ²⁾ 85 °C	ESR _{typ} 85 °C	ESL _{typ} ³⁾	tan δ max	tan δ max	Pcs./ MOQ
	μF			mm	mm	10 kHz	10 kHz	10 kHz	nH	
V _{R,85 °C} = 1500 V DC, V _{op,100 °C} = 1200 V DC										
1.5	24.0x15.0x42.0	–	B32716H7155+000	5.3	4.6	24.0	11.5	0.8	4.3	1040
2.0	24.0x19.0x42.0	–	B32716H7205+000	6.3	5.5	18.3	13.0	0.8	4.3	780
4.0	20.0x39.5x42.0	10.2	B32716H7405+000	10.4	9.0	10.3	13.5	0.8	4.8	640
5.0	28.0x37.0x42.0	10.2	B32716H7505+000	12.4	10.8	8.2	14.0	0.8	4.8	440
6.0	28.0x42.5x42.0	10.2	B32716H7605+000	14.3	12.4	6.8	15.0	0.8	4.8	440
7.0	30.0x45.0x42.0	20.3	B32716H7705+000	16.1	14.0	5.9	16.0	0.8	4.9	400
9.0	33.0x48.0x42.0	20.3	B32716H7905+000*	18.2	15.8	5.1	17.0	0.8	5.3	180
15.0	42.5x60.0x42.5	20.3	B32716H7156K000*	25.3	22.0	3.6	19.0	0.8	6.3	140
V _{R,85 °C} = 1600 V DC, V _{op,100 °C} = 1280 V DC										
1.0	24.0x15.0x42.0	–	B32716H3105+000	4.6	4.0	31.5	11.5	0.8	3.8	1040
1.5	24.0x19.0x42.0	–	B32716H3155+000	5.8	5.0	22.1	12.5	0.8	3.9	780
3.3	20.0x39.5x42.0	10.2	B32716H3335+000	10.4	9.0	10.1	13.0	0.8	3.9	640
4.0	28.0x37.0x42.0	10.2	B32716H3405+000	12.2	10.6	8.5	14.0	0.8	4.0	440
5.0	28.0x42.5x42.0	10.2	B32716H3505+000	14.1	12.3	6.9	15.0	0.8	4.0	440
6.0	30.0x45.0x42.0	20.3	B32716H3605K000	15.6	13.6	6.2	16.0	0.8	4.4	400
7.0	33.0x48.0x42.0	20.3	B32716H3705+000	18.2	15.8	5.1	17.0	0.8	4.2	180
12.0	42.5x60.0x42.5	20.3	B32716H3126K000*	24.5	21.3	3.8	18.5	0.8	5.3	140

MOQ = Minimum Order Quantity, consisting of 4 packing units.

Intermediate capacitance values are available on request.

*) 4-pin version available on request

Composition of ordering code

+ = Capacitance tolerance code:

 J = ±5%
 K = ±10%

*** = Packing code

 000 = untaped (lead length 6 – 1 mm)
 Other lead lengths available upon request

- 1) Capacitance value measured at 1 kHz.
- 2) Max ripple current I_{RMS} at 85 °C, 10 kHz for ΔT ≤ 15 °C, Capacitor body temperature (ambient temperature + self-heating) must be observed for maximum voltage rating. Refer to voltage derating rules in page 20.
- 3) Typical ESL value measured at resonance frequency (see specific graphs of Z versus frequency).

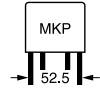
Film Capacitor
Metallized polypropylene Film Capacitor
B32714H ... B32718H
Ordering codes and packing units (lead spacing 52.5 mm)

$C_R^{1)}$	Max. dimensions w x h x l	P1	Ordering code (composition see below)	$I_{RMS,max}$ 70 °C 10 kHz A	$I_{RMS,max}^{2)}$ 85 °C 10 kHz A	ESR_{typ} 85 °C 10 kHz mΩ	$ESL_{typ}^{3)}$	$\tan \delta$ max 1 kHz 10^{-3}	$\tan \delta$ max 10 kHz 10^{-3}	Pcs./ MOQ
μF	mm	mm					nH			
$V_{R,85\text{ °C}} = 500\text{ V DC}, V_{op,100\text{ °C}} = 400\text{ V DC}$										
75.0	30.0x45.0x57.5	20.3	B32718H5756+000	20.7	18.0	4.5	14.5	3.7	36.0	280
80.0	30.0x45.0x57.5	20.3	B32718H5806+000	21.6	18.8	4.1	15.0	3.7	36.0	280
100.0	35.0x50.0x57.5	20.3	B32718H5107+000	25.1	21.8	3.5	16.5	3.8	37.4	108
110.0	35.0x50.0x57.5	20.3	B32718H5117K000	26.2	22.8	3.2	16.5	3.8	37.6	108
130.0	38.0x57.5x57.5	20.3	B32718H5137+000	29.9	26.0	2.8	18.0	4.0	38.9	96
150.0	45.0x55.0x57.5	20.3	B32718H5157+000	33.0	28.8	2.5	16.0	4.1	40.0	140
170.0	45.0x57.0x57.5	20.3	B32718H5177K000	35.0	30.5	2.3	17.0	4.2	41.8	140
$V_{R,85\text{ °C}} = 600\text{ V DC}, V_{op,100\text{ °C}} = 480\text{ V DC}$										
55.0	30.0x45.0x57.5	20.3	B32718H6556+000	19.6	17.0	5.0	14.0	3.0	29.4	280
60.0	30.0x45.0x57.5	20.3	B32718H6606+000	20.1	17.5	4.7	14.5	3.1	30.1	280
75.0	35.0x50.0x57.5	20.3	B32718H6756+000	24.2	21.0	3.8	16.0	3.1	30.4	108
80.0	35.0x50.0x57.5	20.3	B32718H6806+000	25.1	21.8	3.5	16.5	3.1	30.0	108
90.0	38.0x57.5x57.5	20.3	B32718H6906+000	27.6	24.0	3.3	18.0	3.2	31.7	96
95.0	38.0x57.5x57.5	20.3	B32718H6956+000	28.5	24.8	3.1	18.0	3.2	31.5	96
110.0	45.0x55.0x57.5	20.3	B32718H6117+000	30.8	26.8	2.9	16.0	3.4	33.0	140
120.0	45.0x57.0x57.5	20.3	B32718H6127+000	32.9	28.6	2.6	17.0	3.4	33.4	140
140.0	45.0x65.0x57.5	20.3	B32718H6147+000	35.5	31.0	2.4	21.0	3.6	35.9	140
$V_{R,85\text{ °C}} = 800\text{ V DC}, V_{op,100\text{ °C}} = 640\text{ V DC}$										
45.0	30.0x45.0x57.5	20.3	B32718H8456+000	19.0	16.5	5.3	14.5	2.6	25.5	280
50.0	30.0x45.0x57.5	20.3	B32718H8506K000	19.6	17.0	5.0	14.5	2.7	25.8	280
55.0	35.0x50.0x57.5	20.3	B32718H8556+000	22.4	19.5	4.4	16.0	2.7	25.9	108
60.0	35.0x50.0x57.5	20.3	B32718H8606+000	23.5	20.4	4.0	16.5	2.7	25.8	108
70.0	38.0x57.5x57.5	20.3	B32718H8706+000	25.8	22.4	3.8	18.0	2.9	28.4	96
75.0	38.0x57.5x57.5	20.3	B32718H8756+000	26.8	23.3	3.5	18.5	2.9	28.3	96
85.0	45.0x55.0x57.5	20.3	B32718H8856+000	29.3	25.5	3.2	16.5	3.0	29.0	140
90.0	45.0x57.0x57.5	20.3	B32718H8906+000	30.7	26.7	3.0	17.5	3.0	29.0	140
110.0	45.0x65.0x57.5	20.3	B32718H8117K000	33.5	29.2	2.8	21.0	3.4	32.9	140

MOQ = Minimum Order Quantity, consisting of 4 packing units.

Intermediate capacitance values are available on request.

Composition of ordering code

+ = Capacitance tolerance code:

 J = ±5%
 K = ±10%

*** = Packing code

 000 = untaped (lead length 6 – 1 mm)
 Other lead lengths available upon request

- 1) Capacitance value measured at 1 kHz.
- 2) Max ripple current I_{RMS} at 85 °C, 10 kHz for $\Delta T \leq 15\text{ °C}$, Capacitor body temperature (ambient temperature + self-heating) must be observed for maximum voltage rating. Refer to voltage derating rules in page 20.
- 3) Typical ESL value measured at resonance frequency (see specific graphs of Z versus frequency).

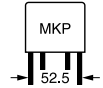
Film Capacitor
Metallized polypropylene Film Capacitor
B32714H ... B32718H
Ordering codes and packing units (lead spacing 52.5 mm)

$C_R^{1)}$	Max. dimensions w x h x l	P1	Ordering code (composition see below)	$I_{RMS,max}$ 70 °C 10 kHz	$I_{RMS,max}^{2)}$ 85 °C 10 kHz	ESR_{typ} 85 °C 10 kHz	$ESL_{typ}^{3)}$	$\tan \delta$ max 1 kHz	$\tan \delta$ max 10 kHz	Pcs./ MOQ
μF	mm	mm		A	A	m Ω	nH	10^{-3}	10^{-3}	
$V_{R,85\text{ °C}} = 900\text{ V DC}, V_{op,100\text{ °C}} = 720\text{ V DC}$										
35.0	30.0x45.0x57.5	20.3	B32718H9356+000	18.2	15.8	5.8	14.5	2.3	22.7	280
45.0	35.0x50.0x57.5	20.3	B32718H9456+000	21.3	18.5	4.9	16.0	2.4	23.0	108
50.0	35.0x50.0x57.5	20.3	B32718H9506K000	22.7	19.7	4.3	16.5	2.4	23.0	108
55.0	38.0x57.5x57.5	20.3	B32718H9556+000	25.4	22.1	3.9	18.0	2.4	23.0	96
60.0	38.0x57.5x57.5	20.3	B32718H9606+000	26.5	23.0	3.6	18.5	2.4	23.1	96
65.0	45.0x55.0x57.5	20.3	B32718H9656+000	28.9	25.1	3.3	16.5	2.4	23.2	140
70.0	45.0x57.0x57.5	20.3	B32718H9706+000	30.7	26.7	3.0	17.5	2.4	23.2	140
85.0	45.0x65.0x57.5	20.3	B32718H9856K000	33.0	28.7	2.8	21.5	2.6	25.4	140
$V_{R,85\text{ °C}} = 1000\text{ V DC}, V_{op,100\text{ °C}} = 800\text{ V DC}$										
25.0	30.0x45.0x57.5	20.3	B32718H0256+000	16.2	14.1	7.2	14.5	2.0	19.5	280
30.0	30.0x45.0x57.5	20.3	B32718H0306K000	17.5	15.2	6.0	15.0	2.1	19.9	280
35.0	35.0x50.0x57.5	20.3	B32718H0356+000	20.5	17.8	5.3	16.5	2.1	19.9	108
40.0	35.0x50.0x57.5	20.3	B32718H0406+000	21.6	18.8	4.7	16.5	2.1	20.0	108
45.0	38.0x57.5x57.5	20.3	B32718H0456+000	24.7	21.5	4.1	18.0	2.1	20.0	96
50.0	38.0x57.5x57.5	20.3	B32718H0506+000	25.8	22.4	3.8	18.5	2.1	20.3	96
55.0	45.0x55.0x57.5	20.3	B32718H0556+000	28.1	24.4	3.5	17.0	2.1	20.6	140
58.0	45.0x57.0x57.5	20.3	B32718H0586+000	29.7	25.8	3.2	18.5	2.1	20.6	140
65.0	45.0x65.0x57.5	20.3	B32718H0656+000	31.9	27.7	3.0	21.5	2.2	20.9	140
$V_{R,85\text{ °C}} = 1100\text{ V DC}, V_{op,100\text{ °C}} = 880\text{ V DC}$										
22.0	30.0x45.0x57.5	20.3	B32718H1226+000	16.1	14.0	7.4	14.5	1.8	17.5	280
25.0	30.0x45.0x57.5	20.3	B32718H1256K000	16.9	14.7	6.7	15.0	1.8	17.6	280
27.0	35.0x50.0x57.5	20.3	B32718H1276+000	19.2	16.7	6.0	16.0	1.8	17.6	108
30.0	35.0x50.0x57.5	20.3	B32718H1306+000	20.6	17.9	5.2	16.0	1.8	17.7	108
35.0	38.0x57.5x57.5	20.3	B32718H1356+000	22.9	19.9	4.8	18.0	1.8	17.9	96
40.0	38.0x57.5x57.5	20.3	B32718H1406+000	24.5	21.3	4.2	18.5	1.9	18.0	96
45.0	45.0x57.0x57.5	20.3	B32718H1456+000	27.3	23.7	3.8	19.0	1.9	18.3	140
55.0	45.0x65.0x57.5	20.3	B32718H1556+000	30.8	26.8	3.2	21.0	2.0	18.8	140

MOQ = Minimum Order Quantity, consisting of 4 packing units.

Intermediate capacitance values are available on request.

Composition of ordering code

+ = Capacitance tolerance code:

 J = $\pm 5\%$
 K = $\pm 10\%$

*** = Packing code

 000 = untaped (lead length 6 – 1 mm)
 Other lead lengths available upon request

- 1) Capacitance value measured at 1 kHz.
- 2) Max ripple current I_{RMS} at 85 °C, 10 kHz for $\Delta T \leq 15\text{ °C}$, Capacitor body temperature (ambient temperature + self-heating) must be observed for maximum voltage rating. Refer to voltage derating rules in page 20.
- 3) Typical ESL value measured at resonance frequency (see specific graphs of Z versus frequency).

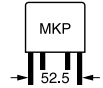
Film Capacitor
Metallized polypropylene Film Capacitor
B32714H ... B32718H
Ordering codes and packing units (lead spacing 52.5 mm)

$C_R^{1)}$	Max. dimensions w x h x l	P1	Ordering code (composition see below)	$I_{RMS,max}$ 70 °C 10 kHz A	$I_{RMS,max}^{2)}$ 85 °C 10 kHz A	ESR_{typ} 85 °C 10 kHz mΩ	$ESL_{typ}^{3)}$ nH	$\tan \delta$ max 1 kHz 10^{-3}	$\tan \delta$ max 10 kHz 10^{-3}	Pcs./ MOQ
μF	mm	mm								
$V_{R,85\text{ °C}} = 1200\text{ V DC}$, $V_{op,100\text{ °C}} = 960\text{ V DC}$										
20.0	30.0x45.0x57.5	20.3	B32718H2206+000	16.2	14.1	7.3	14.5	1.7	15.6	280
25.0	35.0x50.0x57.5	20.3	B32718H2256+000	19.3	16.8	5.9	16.0	1.7	15.6	108
27.0	35.0x50.0x57.5	20.3	B32718H2276+000	20.2	17.6	5.4	16.0	1.7	15.7	108
30.0	38.0x57.5x57.5	20.3	B32718H2306+000	22.4	19.5	5.0	18.0	1.7	15.8	96
33.0	38.0x57.5x57.5	20.3	B32718H2336+000	23.7	20.6	4.5	18.5	1.7	15.9	96
35.0	45.0x55.0x57.5	20.3	B32718H2356+000	25.3	22.0	4.3	17.0	1.8	16.0	140
40.0	45.0x57.0x57.5	20.3	B32718H2406+000	27.3	23.7	3.8	18.5	1.8	16.2	140
47.0	45.0x65.0x57.5	20.3	B32718H2476+000	30.5	26.5	3.3	21.5	1.8	16.5	140
$V_{R,85\text{ °C}} = 1400\text{ V DC}$, $V_{op,100\text{ °C}} = 1120\text{ V DC}$										
15.0	30.0x45.0x57.5	20.3	B32718H4156K000	15.1	13.1	8.4	14.5	1.4	13.5	280
20.0	35.0x50.0x57.5	20.3	B32718H4206K000	18.7	16.3	6.3	16.0	1.4	13.5	108
25.0	38.0x57.5x57.5	20.3	B32718H4256K000	22.2	19.3	5.1	18.5	1.4	13.7	96
30.0	45.0x57.0x57.5	20.3	B32718H4306K000	25.3	22.0	4.4	18.5	1.5	14.0	140
35.0	45.0x65.0x57.5	20.3	B32718H4356K000	28.3	24.6	3.8	21.0	1.5	14.2	140

MOQ = Minimum Order Quantity, consisting of 4 packing units.

Intermediate capacitance values are available on request.

Composition of ordering code

+ = Capacitance tolerance code:

J = ±5%
K = ±10%

*** = Packing code

000 = untaped (lead length 6 –1 mm)
Other lead lengths available upon request

- 1) Capacitance value measured at 1 kHz.
- 2) Max ripple current I_{RMS} at 85 °C, 10 kHz for $\Delta T \leq 15\text{ °C}$, Capacitor body temperature (ambient temperature + self-heating) must be observed for maximum voltage rating. Refer to voltage derating rules in page 20.
- 3) Typical ESL value measured at resonance frequency (see specific graphs of Z versus frequency).

Film Capacitor
Metallized polypropylene Film Capacitor
B32714H ... B32718H
Ordering codes and packing units (lead spacing 52.5 mm)

$C_R^{1)}$	Max. dimensions w x h x l	P1	Ordering code (composition see below)	$I_{RMS,max}$ 70 °C 10 kHz	$I_{RMS,max}^{2)}$ 85 °C 10 kHz	ESR_{typ} 85 °C 10 kHz	$ESL_{typ}^{3)}$	$\tan \delta$ max 1 kHz	$\tan \delta$ max 10 kHz	Pcs./ MOQ
μF	mm	mm		A	A	m Ω	nH	10^{-3}	10^{-3}	
$V_{R,85\text{ °C}} = 1500\text{ V DC}$, $V_{op,100\text{ °C}} = 1200\text{ V DC}$										
10.0	30.0x45.0x57.5	20.3	B32718H7106+000*	13.6	11.8	10.4	14.5	1.3	11.1	280
15.0	35.0x50.0x57.5	20.3	B32718H7156K000*	17.4	15.1	7.3	16.5	1.3	11.2	108
18.0	38.0x57.5x57.5	20.3	B32718H7186+000*	20.7	18.0	5.9	18.0	1.3	11.3	96
20.0	45.0x57.0x57.5	20.3	B32718H7206+000*	22.9	19.9	5.4	18.5	1.3	11.5	140
25.0	45.0x65.0x57.5	20.3	B32718H7256+000*	26.7	23.2	4.3	21.0	1.3	11.5	140
$V_{R,85\text{ °C}} = 1600\text{ V DC}$, $V_{op,100\text{ °C}} = 1280\text{ V DC}$										
8.0	30.0x45.0x57.5	20.3	B32718H3805+000*	12.8	11.1	11.6	14.5	1.2	10.1	280
12.0	35.0x50.0x57.5	20.3	B32718H3126K000*	16.4	14.3	8.2	16.5	1.2	10.4	108
15.0	38.0x57.5x57.5	20.3	B32718H3156K000*	19.7	17.1	6.5	18.0	1.2	10.5	96
18.0	45.0x57.0x57.5	20.3	B32718H3186K000*	22.7	19.7	5.5	18.5	1.2	10.6	140
20.0	45.0x65.0x57.5	20.3	B32718H3206K000*	24.7	21.5	5.0	21.5	1.2	10.8	140

MOQ = Minimum Order Quantity, consisting of 4 packing units.

Intermediate capacitance values are available on request.

Composition of ordering code

+ = Capacitance tolerance code:

J = $\pm 5\%$
K = $\pm 10\%$

*** = Packing code

000 = untaped (lead length 6 – 1 mm)
Other lead lengths available upon request

- 1) Capacitance value measured at 1 kHz.
- 2) Max ripple current I_{RMS} at 85 °C, 10 kHz for $\Delta T \leq 15\text{ °C}$, Capacitor body temperature (ambient temperature + self-heating) must be observed for maximum voltage rating. Refer to voltage derating rules in page 20.
- 3) Typical ESL value measured at resonance frequency (see specific graphs of Z versus frequency).

*) This part is affected by "Dual Use" regulations according to the law of the country the production site is located in. Deliveries of such products are subject to prior approval of the respective local authorities bases on customer declarations. The delivery to certain countries may be restricted.

Film Capacitor
Metallized polypropylene Film Capacitor
B32714H ... B32718H
Technical data

 Reference standard: IEC 61071:2007. All data given at $T = 20\text{ }^{\circ}\text{C}$, unless otherwise specified.

Operating temperature range (case)	Max. operating temperature, $T_{op,max}$	+105 °C
	Upper category temperature T_{max}	+105 °C
	Lower category temperature T_{min}	-55 °C
	Rated temperature T_R	+85 °C
Insulation resistance R_{ins} given as time constant $\tau = C_R \cdot R_{ins}$, rel. humidity $\leq 65\%$ (minimum as-delivered values)	$\tau > 10\ 000\text{ s}$ (after 1 min)	
DC test voltage between terminals (10 s)	$1.5 \cdot V_R$	
Voltage test terminal to case (10 s)	2110 V AC, 50 Hz	
Pulse Handling Capability (V/ μs)	I_P (A) / C (μF)	
Reliability: Failure rate λ	5 fit ($\leq 10 \cdot 10^{-9}/\text{h}$) at $0.5 \cdot V_R$, 40 °C For conversion to other operating conditions and temperatures, refer to chapter "Quality, 2 Reliability".	
Service life t_{SL}	95 000 h at V_R and 70 °C	
V_R (V DC) at 85 °C	500 V	600 V
	800 V	900 V
	1000 V	1100 V
	1200 V	1400 V
	1500 V	1600 V
Continuous operating voltage V_{op} (V DC) at 100 °C	400 V	480 V
	640 V	720 V
	800 V	880 V
	960 V	1120 V
	1200 V	1280 V
Continuous operating voltage (capacitor body temperature between 85 °C and 105 °C)	1.33%/°C of V_{op} derating compared to V_{op} at 85 °C	

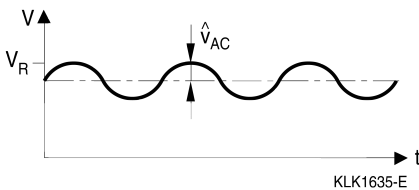
Typical waveforms

Film Capacitor
Metallized polypropylene Film Capacitor
B32714H ... B32718H

Restrictions:

 V_R : Maximum operating peak voltage of either polarity but of a non-reversing waveform, for which the capacitor has been designed for continuous operation.

$$\hat{U}_{AC} \leq 0.2 \cdot V_R \quad (V_R \leq 1200 \text{ V DC})$$

$$\hat{U}_{AC} \leq 0.15 \cdot V_R \quad (V_R \geq 1400 \text{ V DC})$$

Overvoltage	Maximum duration within one day	Observation
$1.1 \cdot V_R$	30% of on-load duration	System regulation
$1.15 \cdot V_R$	30 min	System regulation
$1.2 \cdot V_R$	5 min	System regulation
$1.3 \cdot V_R$	1 min	System regulation

NOTE 1 An overvoltage equal to $1.5 \cdot V_R$ for 30 ms is permitted 1000 times during the life of the capacitor.

The amplitudes of the overvoltages that may be tolerated without significant reduction in the life time of the capacitor depend on their duration, the number of application and the capacitor temperature.

In addition these values assume that the overvoltages may appear when the internal temperature of the capacitor is less than 0 °C but within the temperature category.

NOTE 2 The average applied voltage must not be higher than the specified voltage.

Pulse handling capability

"dV/dt" represents the maximum permissible voltage change per unit of time for non-sinusoidal voltages, expressed in V/μs.

Note:

The values of dV/dt provided below must not be exceeded in order to avoid damaging the capacitor.

dV/dt values (available types)

Lead spacing	27.5 mm									
Type	B32714H									
V_R (85 °C)	500	600	800	900	1000	1100	1200	1400	1500	1600
dV/dt in V/μs	30	35	40	50	75	85	100	120	140	155

Lead spacing	37.5 mm									
Type	B32716H									
V_R (85 °C)	500	600	800	900	1000	1100	1200	1400	1500	1600
dV/dt in V/μs	21	22	25	35	54	63	73	85	100	110

Lead spacing	52.5 mm									
Type	B32718H									
V_R (85 °C)	500	600	800	900	1000	1100	1200	1400	1500	1600
dV/dt in V/μs	14	14	15	22	35	40	50	58	65	75

Film Capacitor

Metallized polypropylene Film Capacitor

B32714H ... B32718H

Characteristics curves

Additional technical information can be found under "Design support" on www.tdk-electronics.tdk.com.

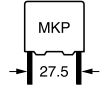

Impedance Z versus frequency f (typical values)

Lead spacing 27.5 mm

500 V DC

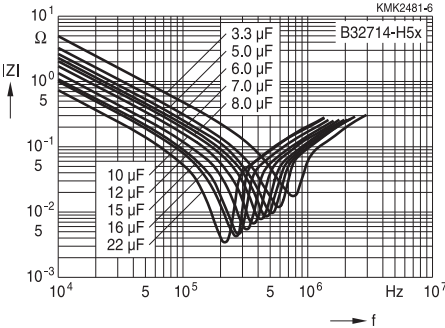

ESR versus frequency f (typical values)

Lead spacing 27.5 mm

500 V DC

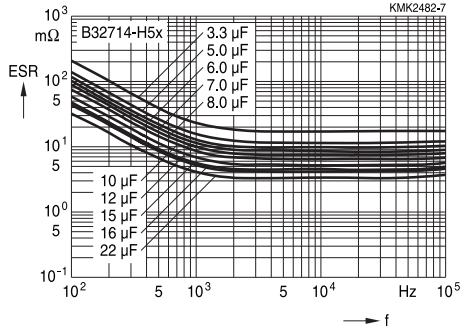

Impedance Z versus frequency f (typical values)

Lead spacing 27.5 mm

600 V DC

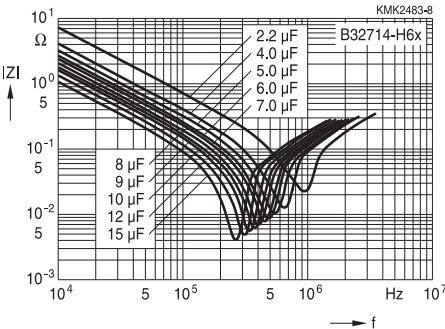

ESR versus frequency f (typical values)

Lead spacing 27.5 mm

600 V DC

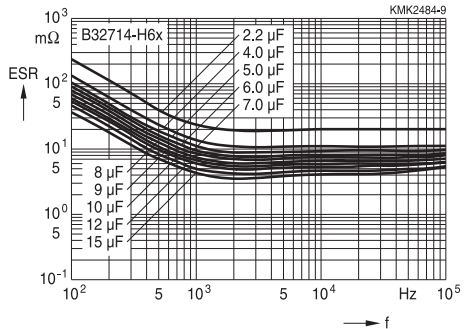

Film Capacitor

Metallized polypropylene Film Capacitor

B32714H ... B32718H

Characteristics curves

Additional technical information can be found under "Design support" on www.tdk-electronics.tdk.com.

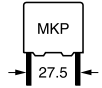

Impedance Z versus frequency f
(typical values)

Lead spacing 27.5 mm

800 V DC

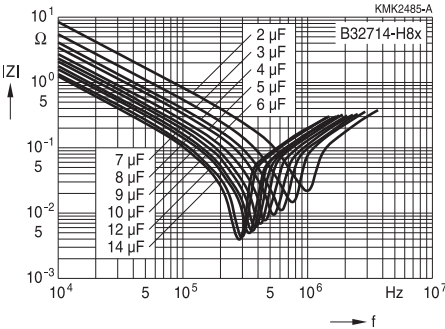

ESR versus frequency f
(typical values)

Lead spacing 27.5 mm

800 V DC

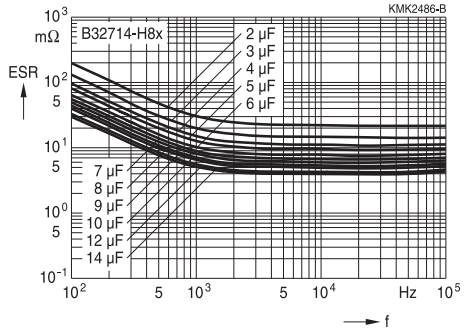

Impedance Z versus frequency f
(typical values)

Lead spacing 27.5 mm

900 V DC

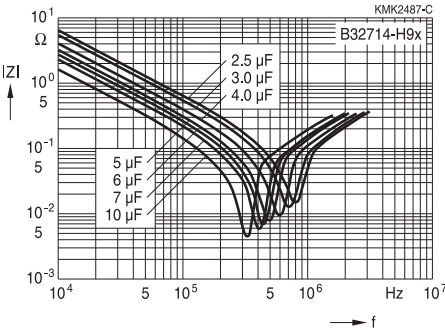

ESR versus frequency f
(typical values)

Lead spacing 27.5 mm

900 V DC

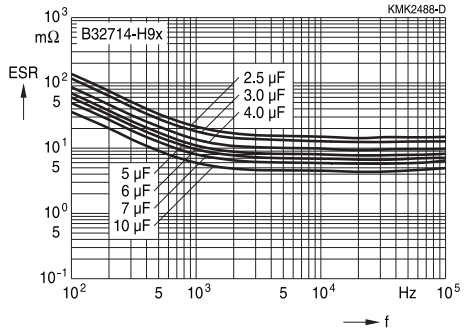

Film Capacitor

Metallized polypropylene Film Capacitor

B32714H ... B32718H

Characteristics curves

Additional technical information can be found under "Design support" on www.tdk-electronics.tdk.com.

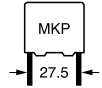

Impedance Z versus frequency f (typical values)

Lead spacing 27.5 mm

1000 V DC

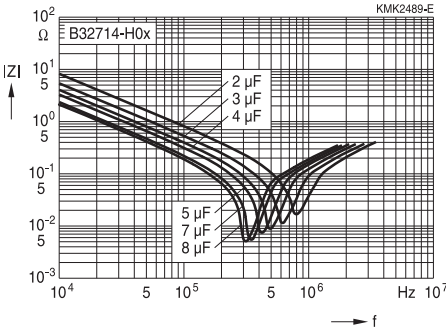

ESR versus frequency f (typical values)

Lead spacing 27.5 mm

1000 V DC

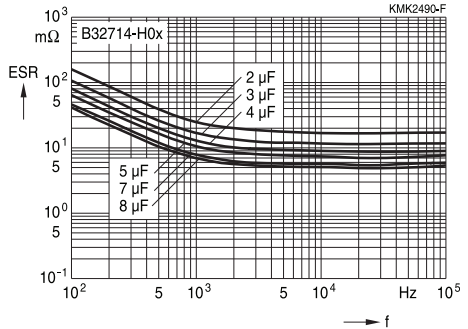

Impedance Z versus frequency f (typical values)

Lead spacing 27.5 mm

1100 V DC

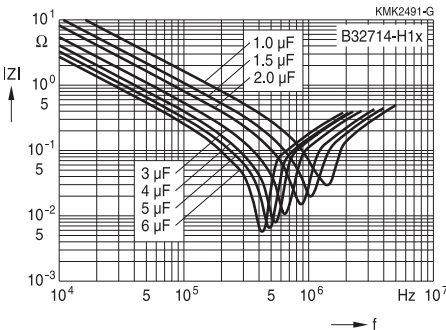

ESR versus frequency f (typical values)

Lead spacing 27.5 mm

1100 V DC

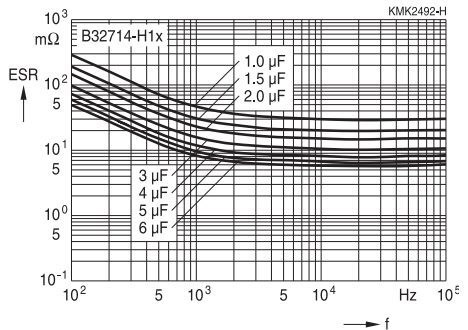

Film Capacitor

Metallized polypropylene Film Capacitor

B32714H ... B32718H

Characteristics curves

Additional technical information can be found under "Design support" on www.tdk-electronics.tdk.com.

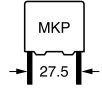

Impedance Z versus frequency f
(typical values)

Lead spacing 27.5 mm

1200 V DC

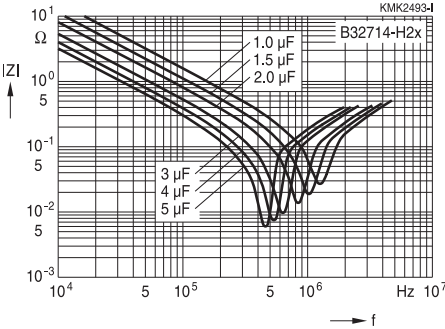

ESR versus frequency f
(typical values)

Lead spacing 27.5 mm

1200 V DC

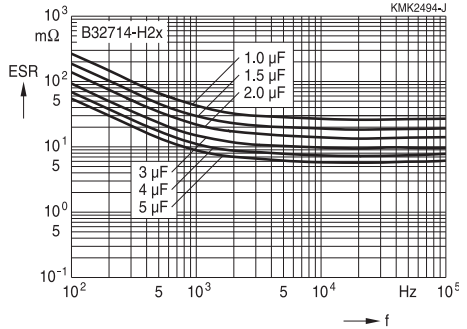

Impedance Z versus frequency f
(typical values)

Lead spacing 27.5 mm

1400 V DC

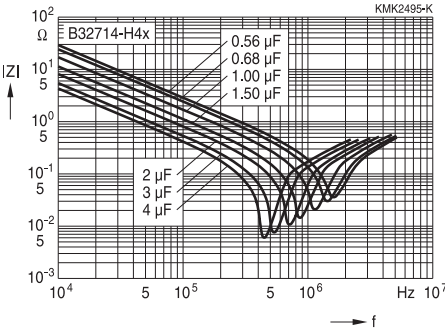

ESR versus frequency f
(typical values)

Lead spacing 27.5 mm

1400 V DC

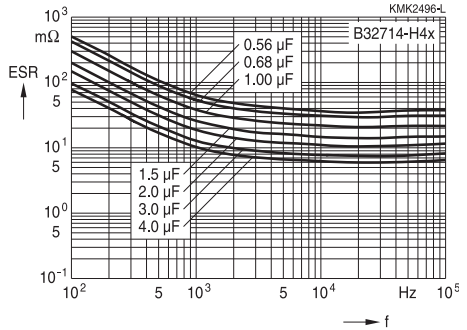

Film Capacitor

Metallized polypropylene Film Capacitor

B32714H ... B32718H

Characteristics curves

Additional technical information can be found under "Design support" on www.tdk-electronics.tdk.com.

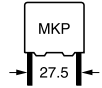

Impedance Z versus frequency f
(typical values)

Lead spacing 27.5 mm

1500 V DC

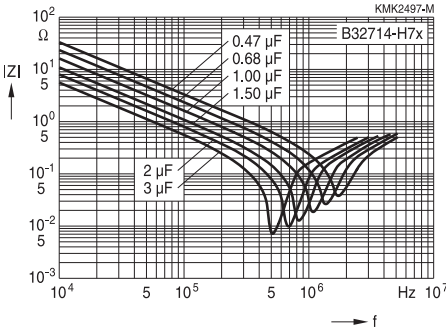

ESR versus frequency f
(typical values)

Lead spacing 27.5 mm

1500 V DC

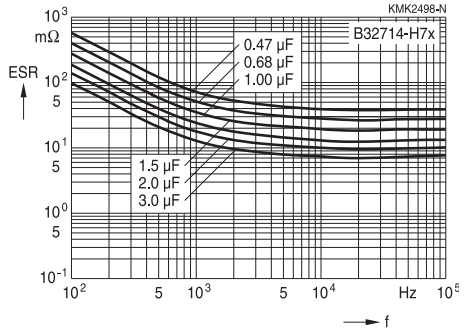

Impedance Z versus frequency f
(typical values)

Lead spacing 27.5 mm

1600 V DC

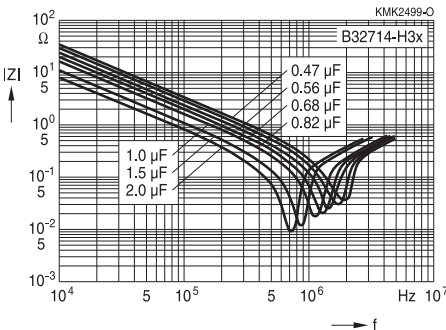

ESR versus frequency f
(typical values)

Lead spacing 27.5 mm

1600 V DC

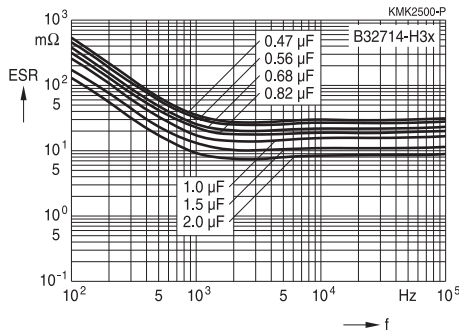

Film Capacitor

Metallized polypropylene Film Capacitor

B32714H ... B32718H

Characteristics curves

Additional technical information can be found under "Design support" on www.tdk-electronics.tdk.com.



Impedance Z versus frequency f (typical values)

Lead spacing 37.5 mm

500 V DC

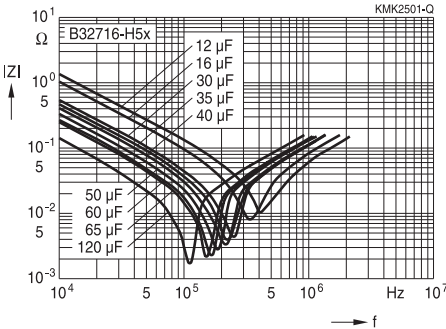

ESR versus frequency f (typical values)

Lead spacing 37.5 mm

500 V DC

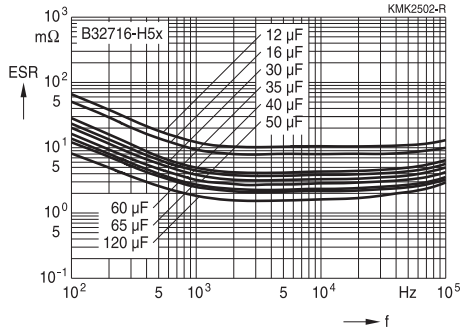

Impedance Z versus frequency f (typical values)

Lead spacing 37.5 mm

600 V DC

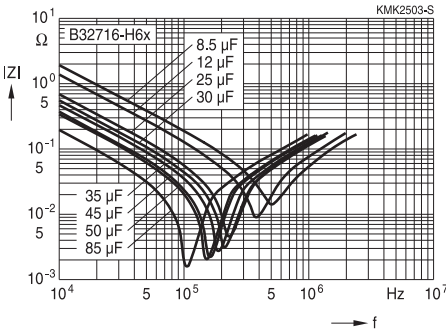

ESR versus frequency f (typical values)

Lead spacing 37.5 mm

600 V DC

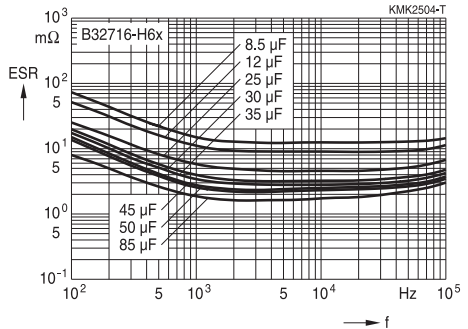

Film Capacitor

Metallized polypropylene Film Capacitor

B32714H ... B32718H

Characteristics curves

Additional technical information can be found under "Design support" on www.tdk-electronics.tdk.com.



Impedance Z versus frequency f (typical values)

Lead spacing 37.5 mm

800 V DC

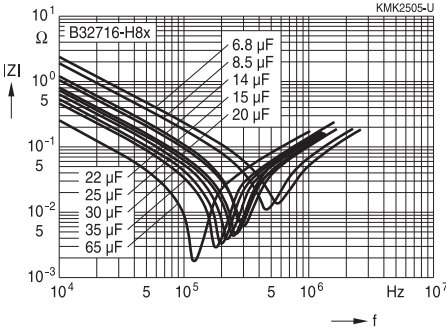

ESR versus frequency f (typical values)

Lead spacing 37.5 mm

800 V DC

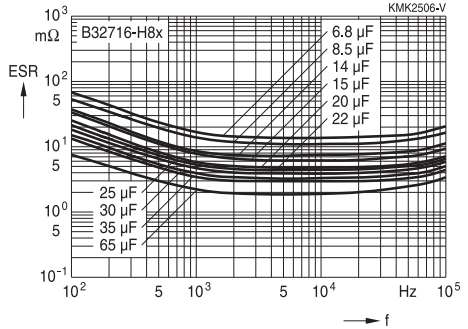

Impedance Z versus frequency f (typical values)

Lead spacing 37.5 mm

900 V DC

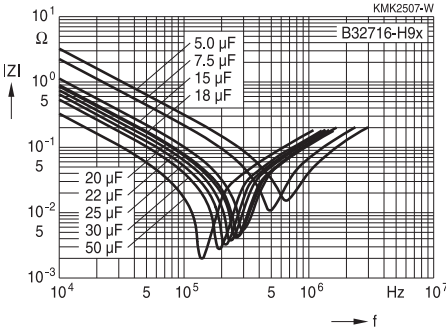

ESR versus frequency f (typical values)

Lead spacing 37.5 mm

900 V DC

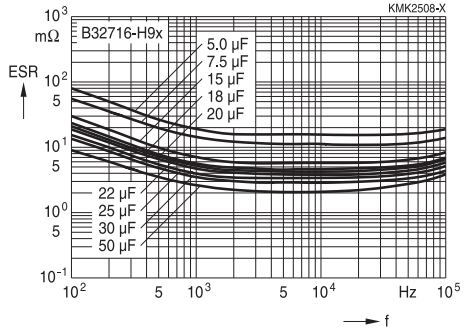

Film Capacitor

Metallized polypropylene Film Capacitor

B32714H ... B32718H

Characteristics curves

Additional technical information can be found under "Design support" on www.tdk-electronics.tdk.com.



Impedance Z versus frequency f (typical values)

Lead spacing 37.5 mm

1000 V DC

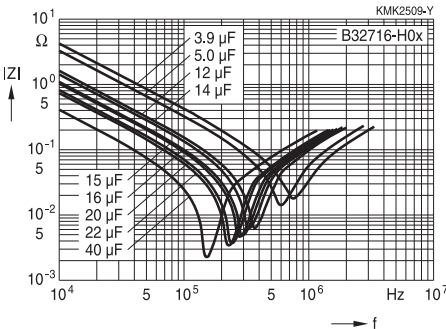

ESR versus frequency f (typical values)

Lead spacing 37.5 mm

1000 V DC

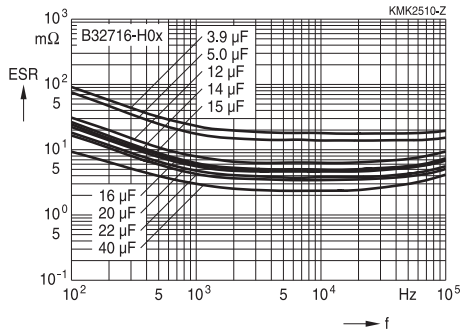

Impedance Z versus frequency f (typical values)

Lead spacing 37.5 mm

1100 V DC

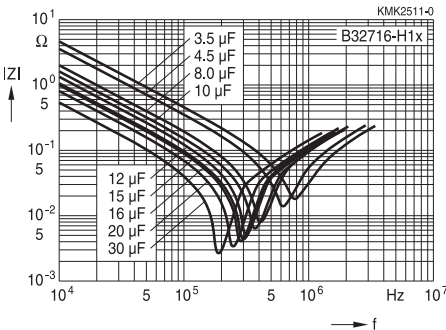

ESR versus frequency f (typical values)

Lead spacing 37.5 mm

1100 V DC

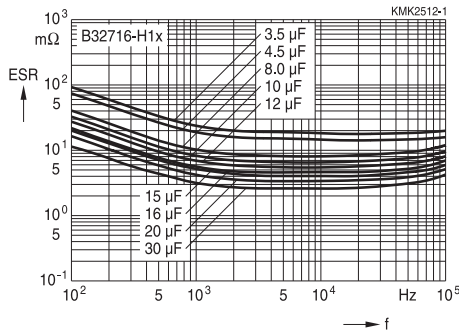

Film Capacitor

Metallized polypropylene Film Capacitor

B32714H ... B32718H

Characteristics curves

Additional technical information can be found under "Design support" on www.tdk-electronics.tdk.com.



Impedance Z versus frequency f (typical values)

Lead spacing 37.5 mm

1200 V DC

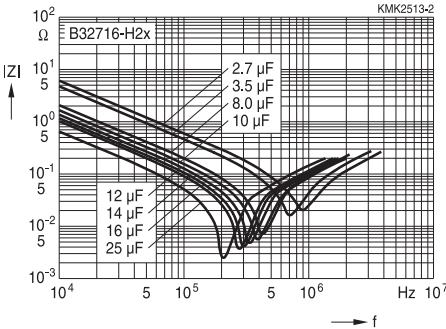

ESR versus frequency f (typical values)

Lead spacing 37.5 mm

1200 V DC

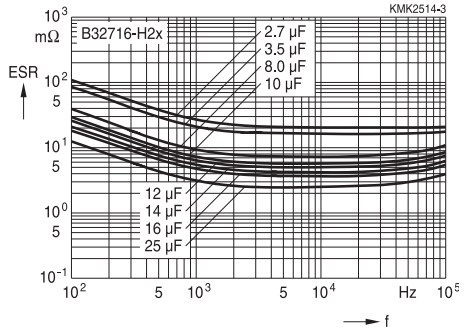

Impedance Z versus frequency f (typical values)

Lead spacing 37.5 mm

1400 V DC

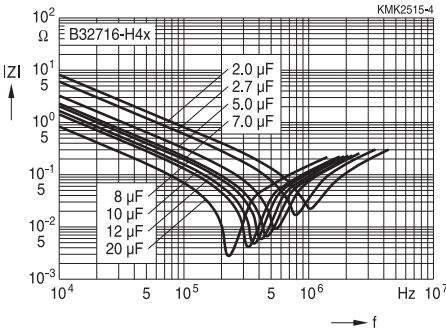

ESR versus frequency f (typical values)

Lead spacing 37.5 mm

1400 V DC

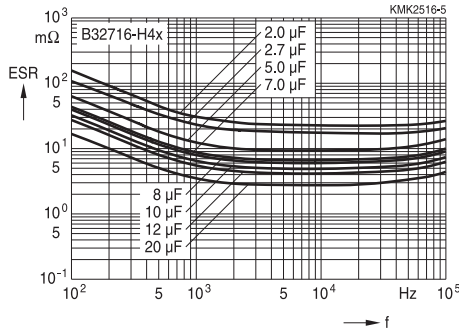

Film Capacitor

Metallized polypropylene Film Capacitor

B32714H ... B32718H

Characteristics curves

Additional technical information can be found under "Design support" on www.tdk-electronics.tdk.com.



Impedance Z versus frequency f
(typical values)

Lead spacing 37.5 mm

1500 V DC

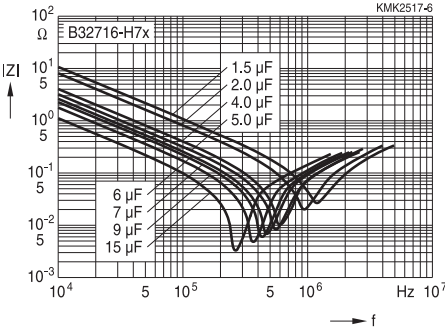

ESR versus frequency f
(typical values)

Lead spacing 37.5 mm

1500 V DC

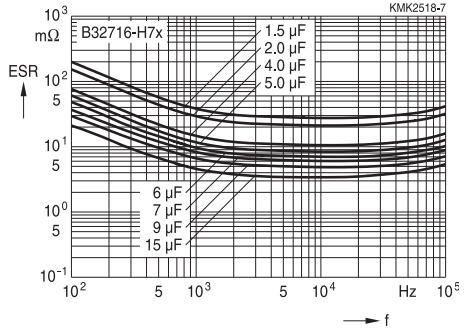

Impedance Z versus frequency f
(typical values)

Lead spacing 37.5 mm

1600 V DC

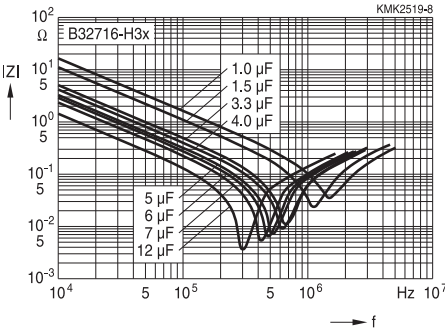

ESR versus frequency f
(typical values)

Lead spacing 37.5 mm

1600 V DC

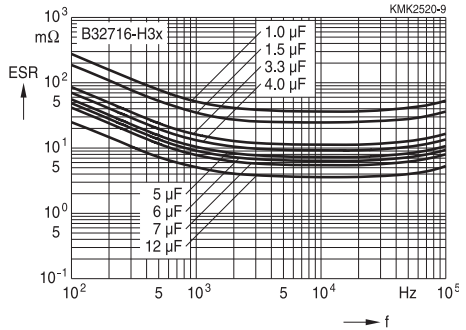

Film Capacitor

Metallized polypropylene Film Capacitor

B32714H ... B32718H

Characteristics curves

Additional technical information can be found under "Design support" on www.tdk-electronics.tdk.com.

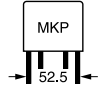

Impedance Z versus frequency f
(typical values)

Lead spacing 52.5 mm

500 V DC

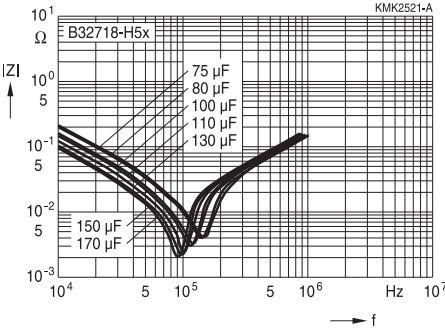

ESR versus frequency f
(typical values)

Lead spacing 52.5 mm

500 V DC

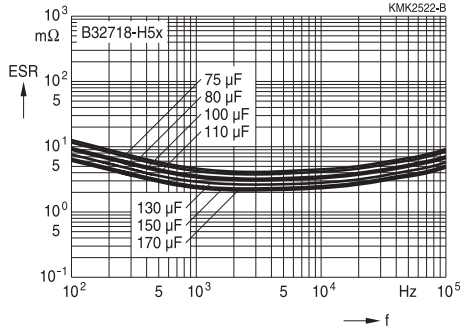

Impedance Z versus frequency f
(typical values)

Lead spacing 52.5 mm

600 V DC

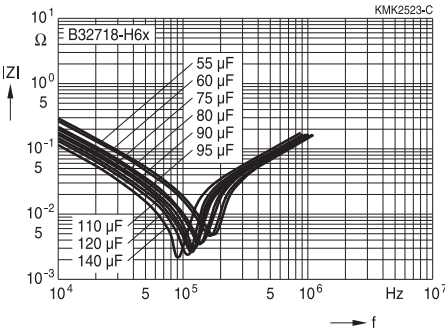

ESR versus frequency f
(typical values)

Lead spacing 52.5 mm

600 V DC

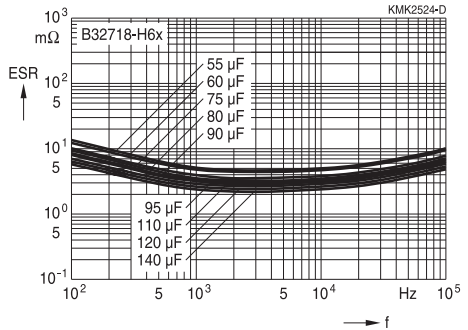

Film Capacitor

Metallized polypropylene Film Capacitor

B32714H ... B32718H

Characteristics curves

Additional technical information can be found under "Design support" on www.tdk-electronics.tdk.com.



Impedance Z versus frequency f (typical values)

Lead spacing 52.5 mm

800 V DC

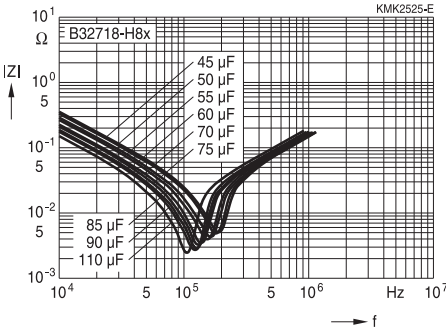

ESR versus frequency f (typical values)

Lead spacing 52.5 mm

800 V DC

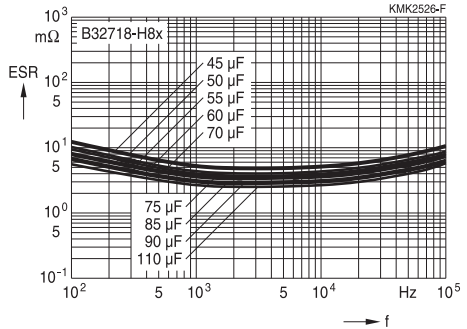

Impedance Z versus frequency f (typical values)

Lead spacing 52.5 mm

900 V DC

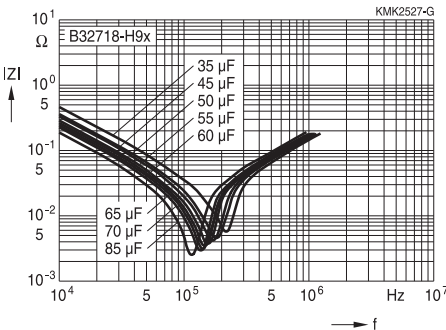

ESR versus frequency f (typical values)

Lead spacing 52.5 mm

900 V DC

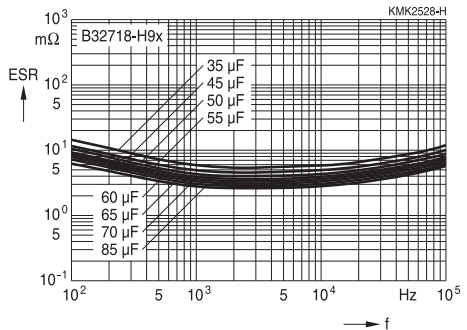

Film Capacitor

Metallized polypropylene Film Capacitor

B32714H ... B32718H

Characteristics curves

Additional technical information can be found under "Design support" on www.tdk-electronics.tdk.com.

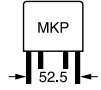

Impedance Z versus frequency f
(typical values)

Lead spacing 52.5 mm

1000 V DC

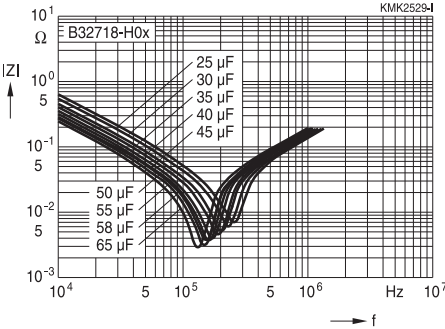

ESR versus frequency f
(typical values)

Lead spacing 52.5 mm

1000 V DC

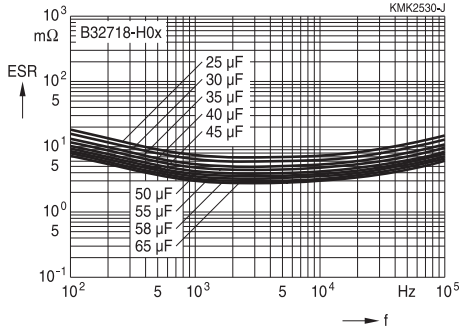

Impedance Z versus frequency f
(typical values)

Lead spacing 52.5 mm

1100 V DC

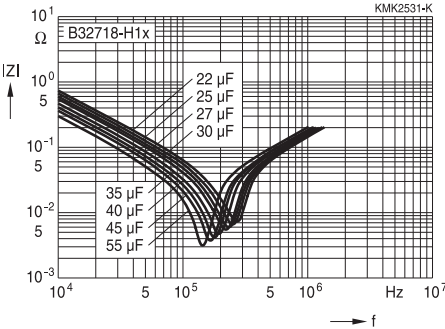

ESR versus frequency f
(typical values)

Lead spacing 52.5 mm

1100 V DC

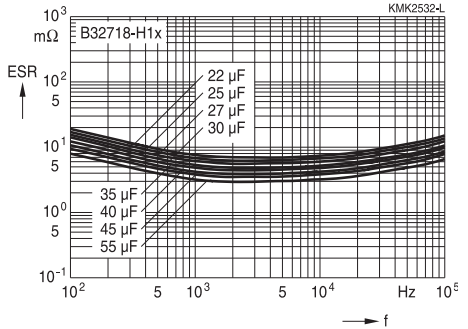

Film Capacitor

Metallized polypropylene Film Capacitor

B32714H ... B32718H

Characteristics curves

Additional technical information can be found under "Design support" on www.tdk-electronics.tdk.com.

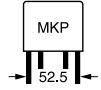

Impedance Z versus frequency f
(typical values)

Lead spacing 52.5 mm

1200 V DC

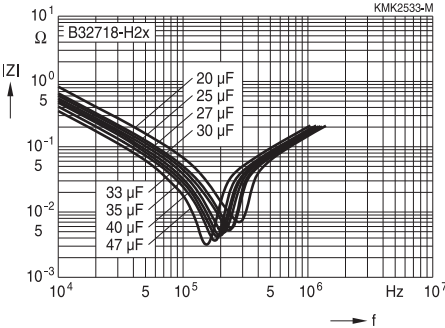

ESR versus frequency f
(typical values)

Lead spacing 52.5 mm

1200 V DC

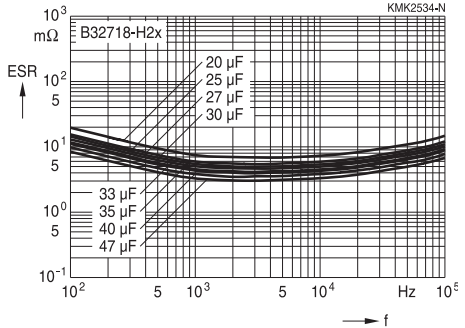

Impedance Z versus frequency f
(typical values)

Lead spacing 52.5 mm

1400 V DC

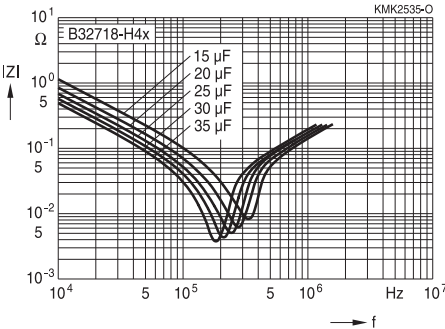

ESR versus frequency f
(typical values)

Lead spacing 52.5 mm

1400 V DC

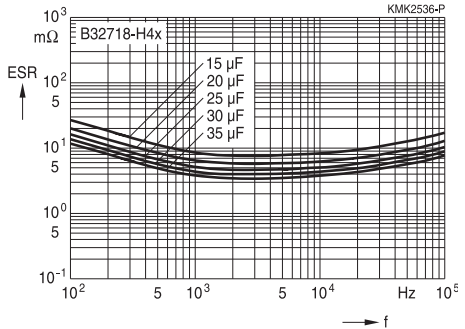

Film Capacitor

Metallized polypropylene Film Capacitor

B32714H ... B32718H

Characteristics curves

Additional technical information can be found under "Design support" on www.tdk-electronics.tdk.com.

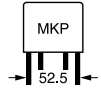

Impedance Z versus frequency f (typical values)

Lead spacing 52.5 mm

1500 V DC

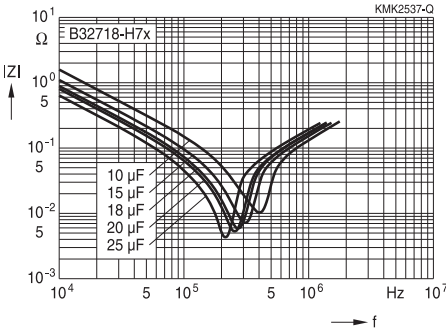

ESR versus frequency f (typical values)

Lead spacing 52.5 mm

1500 V DC

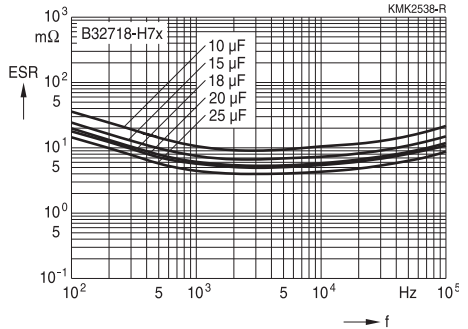

Impedance Z versus frequency f (typical values)

Lead spacing 52.5 mm

1600 V DC

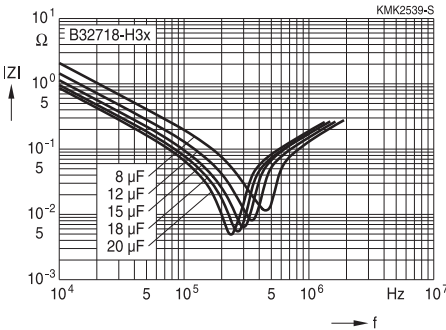

ESR versus frequency f (typical values)

Lead spacing 52.5 mm

1600 V DC

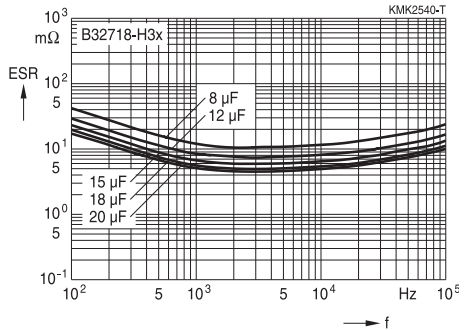

Film Capacitor

Metallized polypropylene Film Capacitor

B32714H ... B32718H

Characteristics curves

Permissible current I_{RMS} versus frequency f at 85 °C

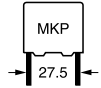

Lead spacing 27.5 mm

500 V DC

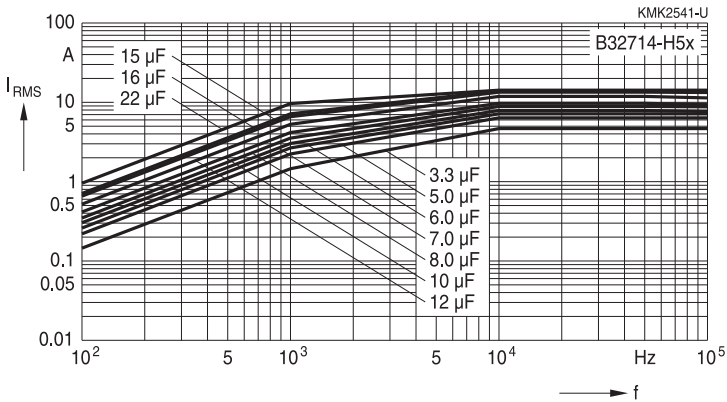

600 V DC

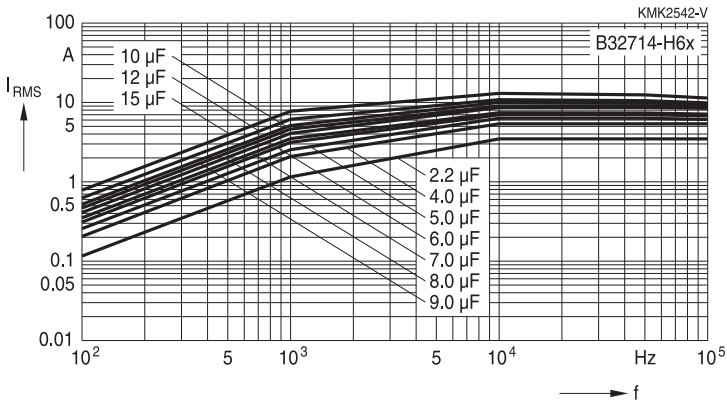

Film Capacitor
Metallized polypropylene Film Capacitor **B32714H ... B32718H**

Characteristics curves

Permissible current I_{RMS} versus frequency f at 85 °C

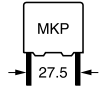

Lead spacing 27.5 mm

800V DC

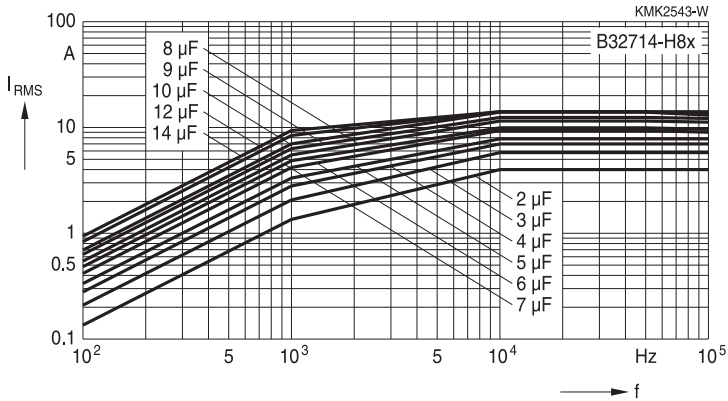

900 V DC

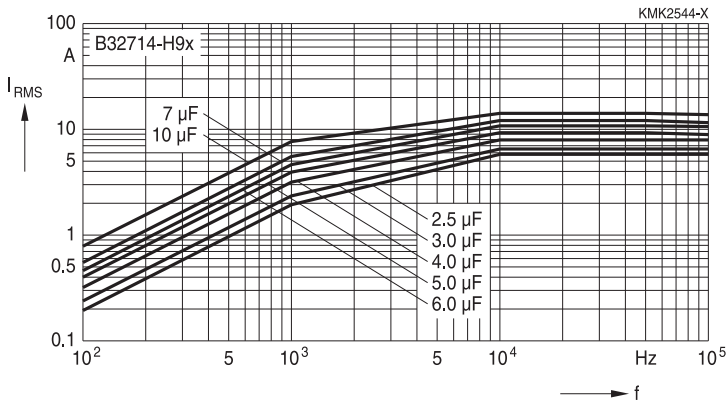

Film Capacitor

Metallized polypropylene Film Capacitor

B32714H ... B32718H

Characteristics curves

Permissible current I_{RMS} versus frequency f at 85 °C

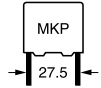

Lead spacing 27.5 mm

1000 V DC

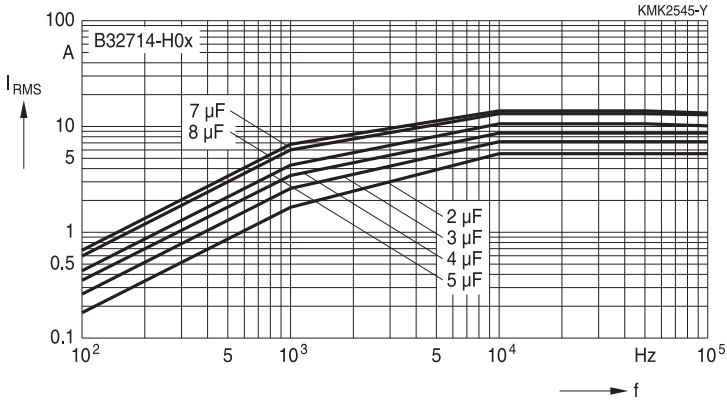

1100 V DC

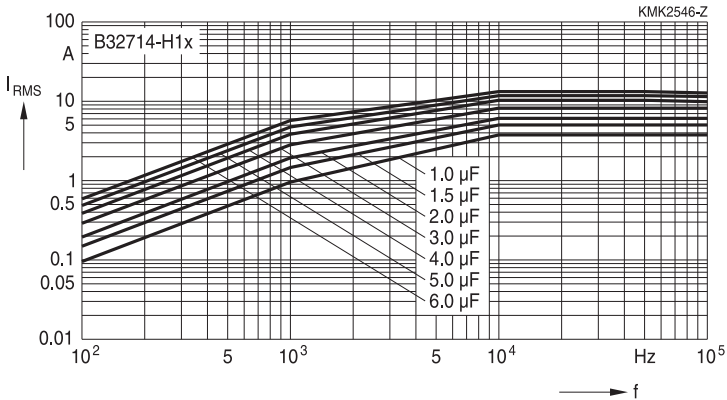

Film Capacitor

Metallized polypropylene Film Capacitor

B32714H ... B32718H

Characteristics curves

Permissible current I_{RMS} versus frequency f at 85 °C

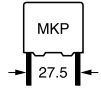

Lead spacing 27.5 mm

1200 V DC

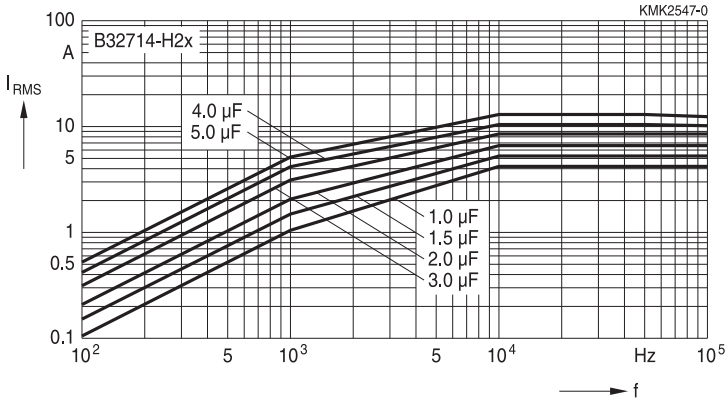

1400 V DC

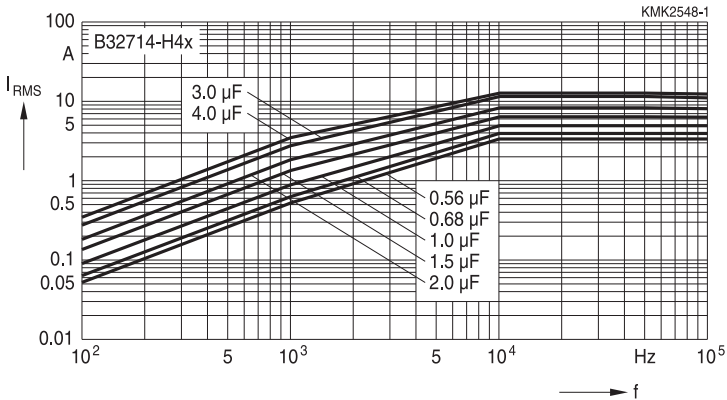

Film Capacitor
Metallized polypropylene Film Capacitor **B32714H ... B32718H**

Characteristics curves

Permissible current I_{RMS} versus frequency f at 85 °C

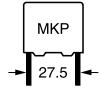

Lead spacing 27.5 mm

1500 V DC

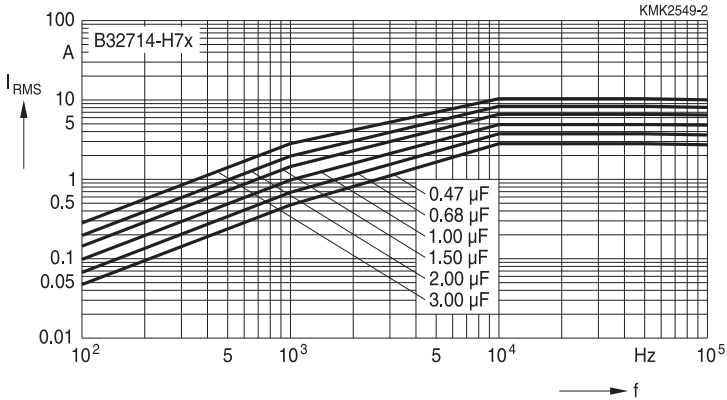

1600 V DC

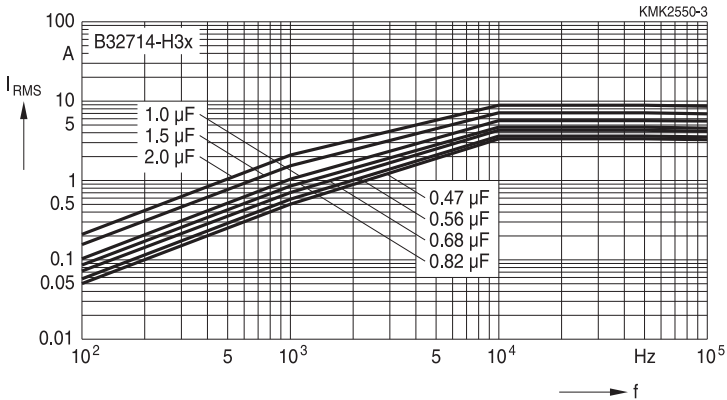

Film Capacitor

Metallized polypropylene Film Capacitor

B32714H ... B32718H

Characteristics curves

Permissible current I_{RMS} versus frequency f at 85 °C



Lead spacing 37.5 mm

500 V DC

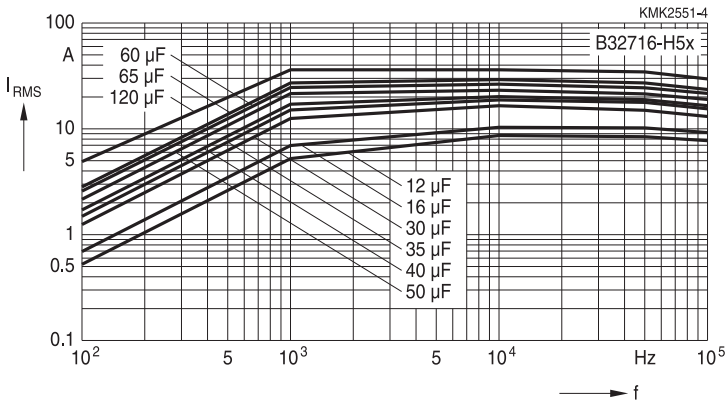

600 V DC

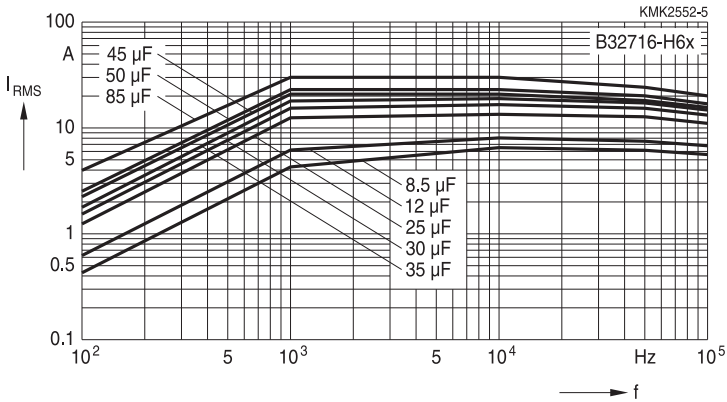

Film Capacitor

Metallized polypropylene Film Capacitor

B32714H ... B32718H

Characteristics curves

Permissible current I_{RMS} versus frequency f at 85 °C



Lead spacing 37.5 mm

800V DC

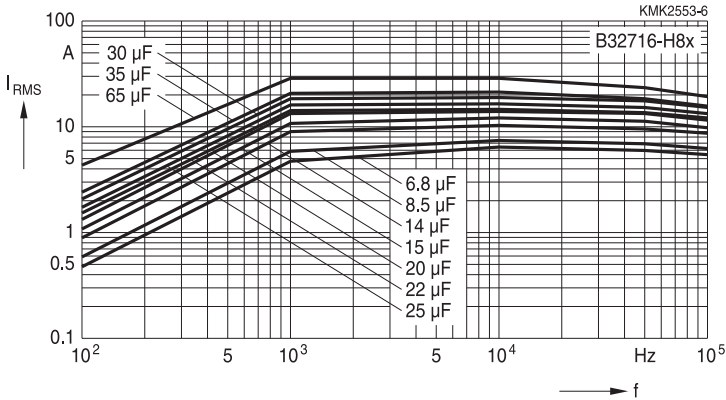

900 V DC

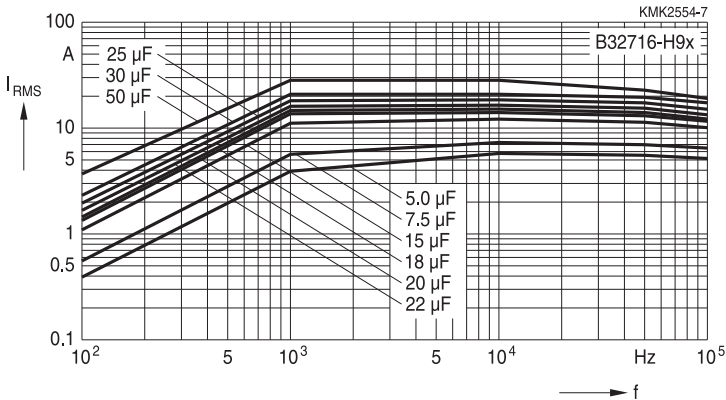

Film Capacitor

Metallized polypropylene Film Capacitor

B32714H ... B32718H

Characteristics curves

Permissible current I_{RMS} versus frequency f at 85 °C



Lead spacing 37.5 mm

1000 V DC

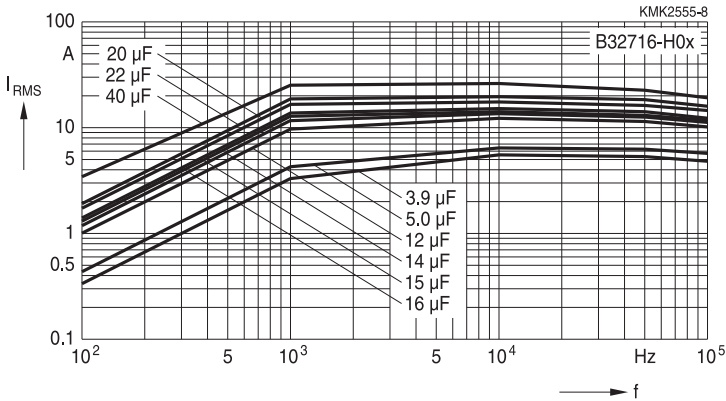

1100 V DC

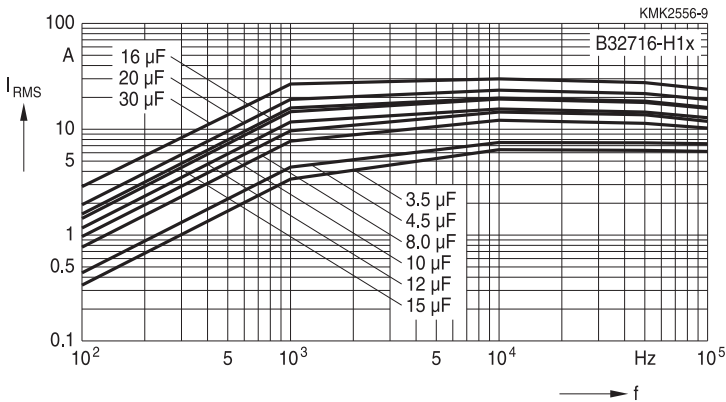

Film Capacitor

Metallized polypropylene Film Capacitor

B32714H ... B32718H

Characteristics curves

Permissible current I_{RMS} versus frequency f at 85 °C



Lead spacing 37.5 mm

1200 V DC

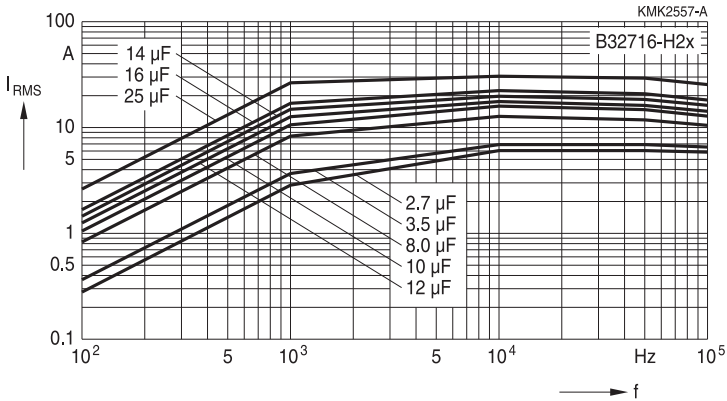

1400 V DC

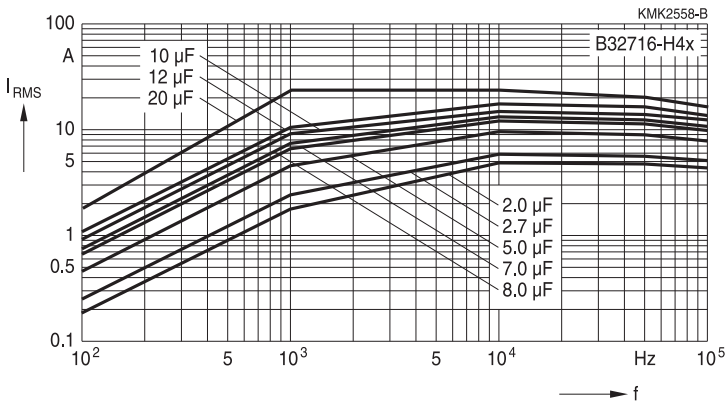

Film Capacitor

Metallized polypropylene Film Capacitor

B32714H ... B32718H

Characteristics curves

Permissible current I_{RMS} versus frequency f at 85 °C



Lead spacing 37.5 mm

1500 V DC

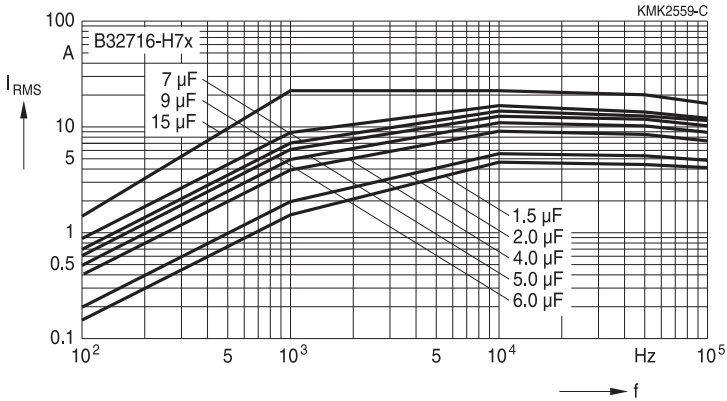

1600 V DC

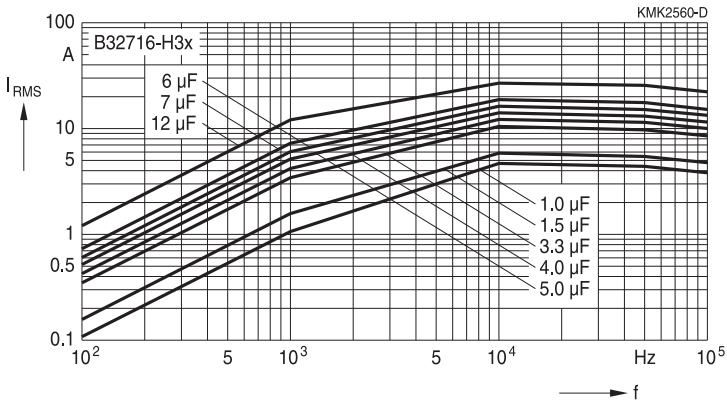

Film Capacitor

Metallized polypropylene Film Capacitor

B32714H ... B32718H

Characteristics curves

Permissible current I_{RMS} versus frequency f at 85 °C



Lead spacing 52.5 mm

500 V DC

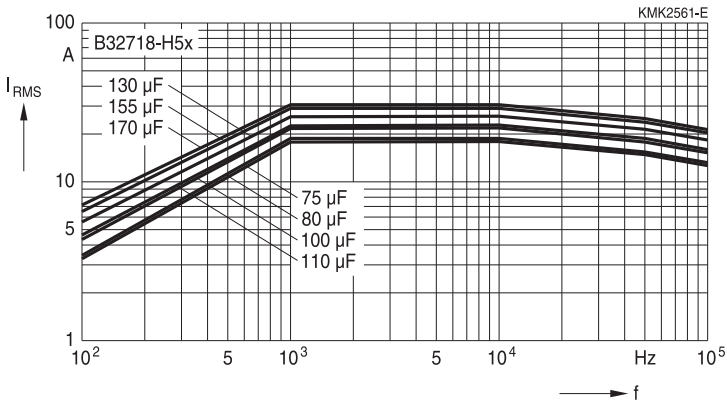

600 V DC

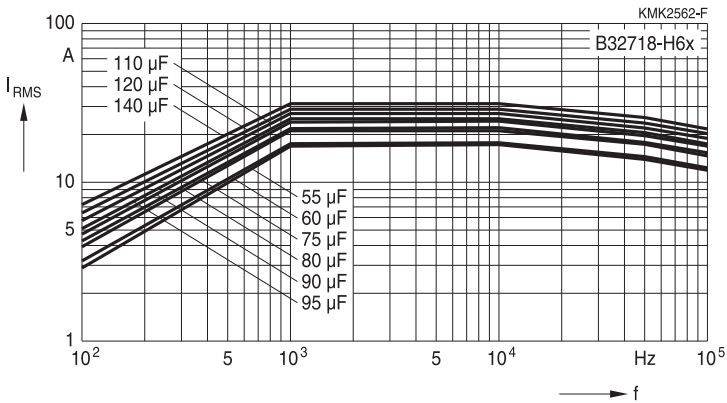

Film Capacitor

Metallized polypropylene Film Capacitor

B32714H ... B32718H

Characteristics curves

Permissible current I_{RMS} versus frequency f at 85 °C



Lead spacing 52.5 mm

800 V DC

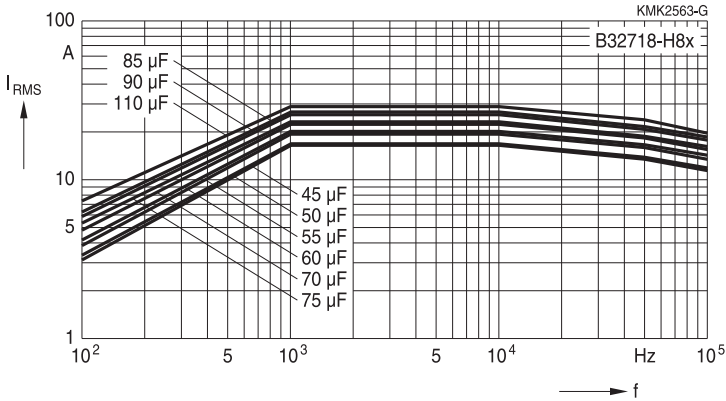

900 V DC

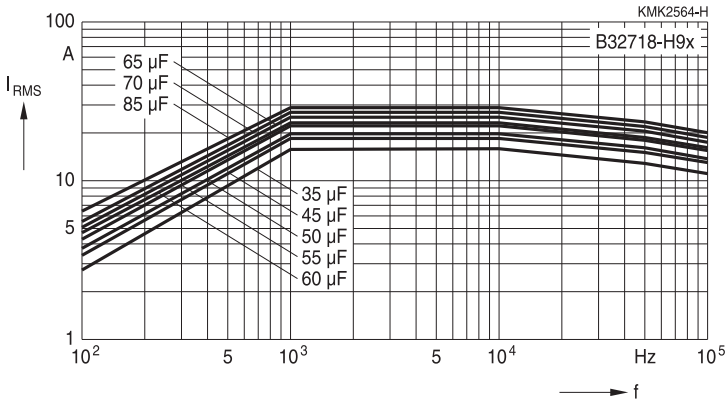

Film Capacitor

Metallized polypropylene Film Capacitor

B32714H ... B32718H

Characteristics curves

Permissible current I_{RMS} versus frequency f at 85 °C



Lead spacing 52.5 mm

1000 V DC

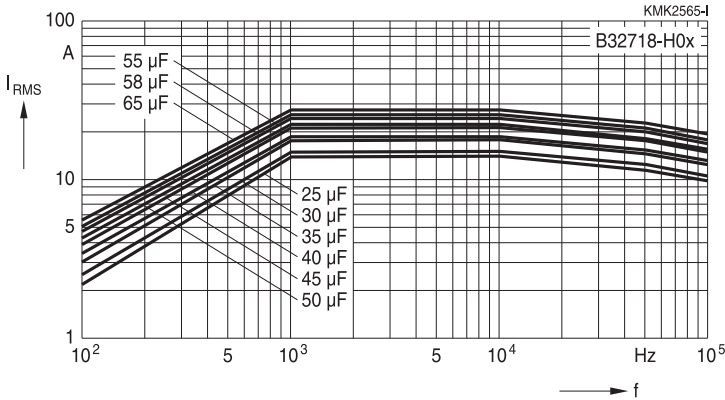

1100 V DC

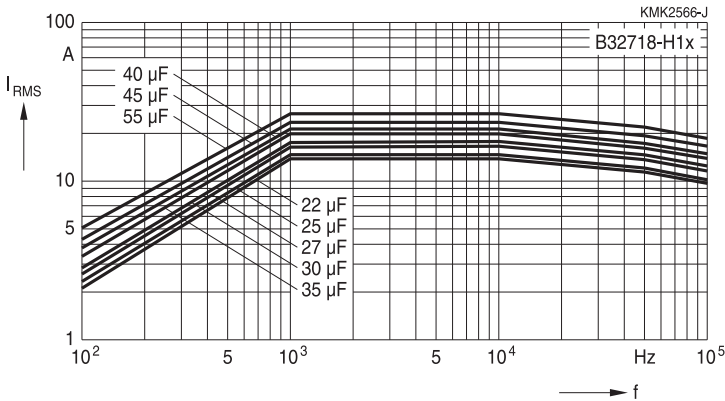

Film Capacitor

Metallized polypropylene Film Capacitor

B32714H ... B32718H

Characteristics curves

Permissible current I_{RMS} versus frequency f at 85 °C



Lead spacing 52.5 mm

1200 V DC

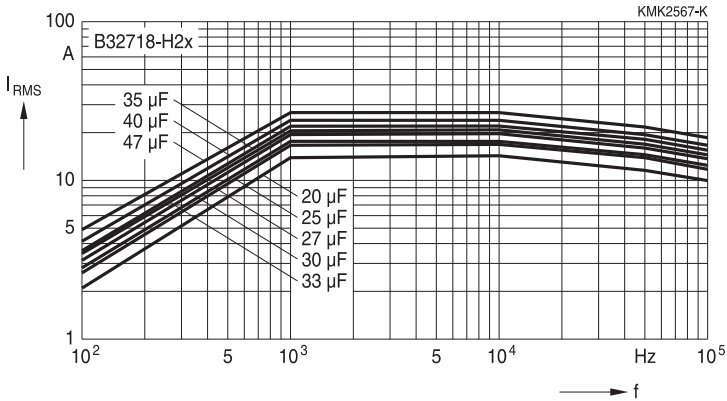

1400 V DC

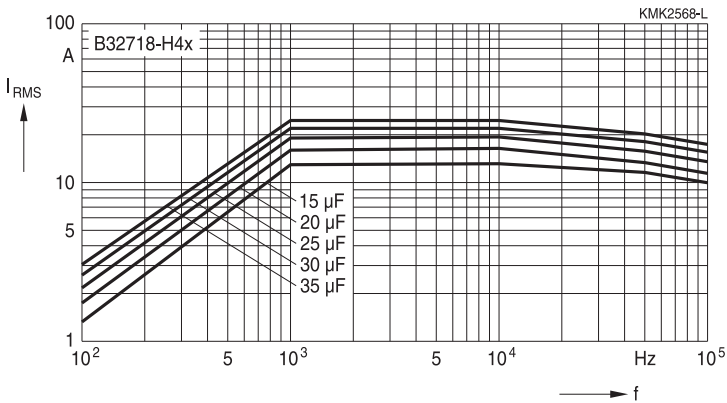

Film Capacitor
Metallized polypropylene Film Capacitor **B32714H ... B32718H**

Characteristics curves

Permissible current I_{RMS} versus frequency f at 85 °C



Lead spacing 52.5 mm

1500 V DC

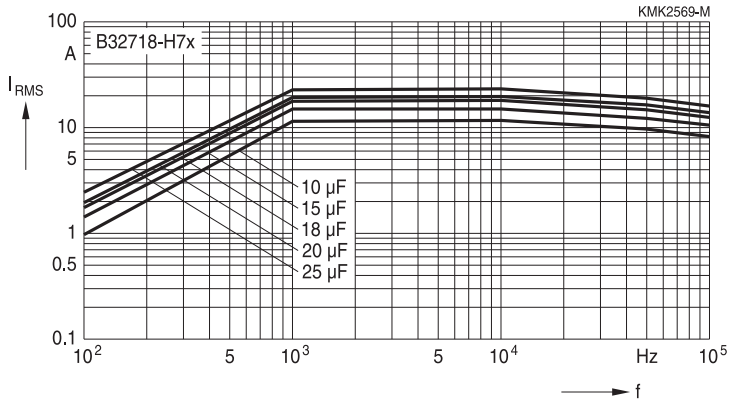

1600 V DC

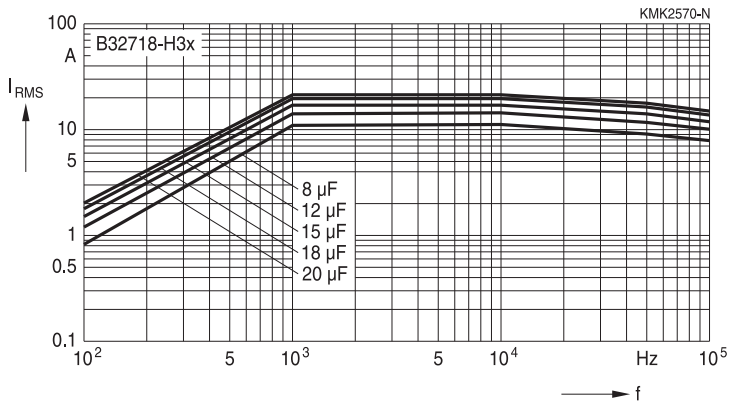

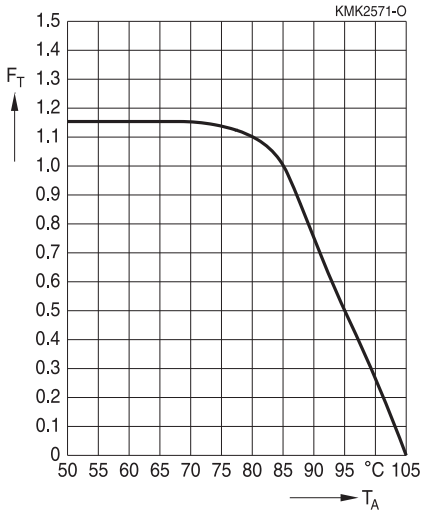
Curves characteristics (I_{RMS} derating versus temperature)

Maximum I_{RMS} current as function of the ambient temperature: $I_{RMS}(T_A) = \text{Factor} \times I_{RMS}(85\text{ °C})$

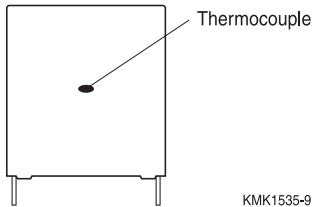
Heat transference for self heating calculation

Figure 1

Box dimensions			Equivalent heat coefficient
w (mm)	h (mm)	l (mm)	G (mW/°C)
9.0	18.0	31.5	22
11.0	19.0	31.5	25
11.0	21.0	31.5	28
12.5	21.5	31.5	30
13.5	23.0	31.5	32
14.0	24.5	31.5	35
15.0	24.5	31.5	36
16.0	30.0	31.5	40
18.0	27.5	31.5	44
18.0	33.0	31.5	48
19.0	30.0	31.5	48
21.0	31.0	31.5	51
22.0	36.5	31.5	58
18.0	32.5	42.0	59
20.0	39.5	42.0	72
24.0	19.0	42.0	50
24.0	15.0	42.0	44
28.0	37.0	42.0	83
24.0	44.0	42.0	84
28.0	42.5	42.0	90
30.0	45.0	42.0	100
33.0	48.0	42.0	110
42.5	60.0	42.5	150
30.0	45.0	57.5	125
35.0	50.0	57.5	145
38.0	57.5	57.5	165
45.0	55.0	57.5	180
45.0	57.0	57.5	185
45.0	65.0	57.5	200

The equivalent heat coefficient "**G (mW/°C)**" is given for measuring the temperature on the lateral surface of the plastic box as Figure 1 shows. By using a thermocouple and avoiding effect of radiation and convection the temperature measured during operation conditions should be a result of the dissipated power divided by the equivalent heat coefficient.

Self Heating by power dissipation & equivalent heat coefficient

The I_{RMS} and consequently the power dissipation must be limited during operation in order to not exceed the maximum limit of ΔT allowed for this series. ΔT_{max} given for this series is equal or lower than 15 °C at rated temperature (85 °C), for higher ambient temperatures $\Delta T_{max}(T)$ will have the same derating factor than I_{RMS} versus temperature and then an equivalent derating as per:

$$\Delta T_{max}(T) = (\text{Factor})^2 \times \Delta T(85\text{ °C}).$$

For any particular I_{RMS} the ΔT may be calculated by:

$$\Delta T(\text{°C}) = P_{dis}(\text{mW}) / G(\text{mW/°C}).$$

Where $\Delta T(\text{°C})$ is the difference between the temperature measured on the box (see Figure 1) and the ambient temperature when capacitor is working during normal operation;

$$\Delta T(\text{°C}) = T_{op}(\text{°C}) - T_A(\text{°C}).$$

It represents the increasing of temperature provoked by the I_{RMS} during operation.

$G(\text{mW/°C})$ is the equivalent heat coefficient described above and $P_{dis}(\text{mW})$ is the dissipated power defined by:

$$P_{dis}(\text{mW}) = ESR_{typ}(\text{m}\Omega) \times I_{RMS}^2(A_{RMS}).$$

Example for thermal calculation:

We will take as reference B32718H0306K (30 $\mu\text{F}/1000\text{ V}$) type for thermal calculation. Considering the following load and capacitor characteristics:

I_{RMS} : 7 A_{RMS} at 10 kHz T_A : 95 °C 30 × 45 × 57.5 box

$G(\text{mW/°C})$: 125

Then we have to find the ESR_{typ} at 10 kHz what is approx. 6.0 m Ω .

So according to:

$$P_{dis}(\text{mW}) = ESR_{typ}(\text{m}\Omega) \times I_{RMS}^2(A_{RMS})$$

we have the following:

$$P_{dis}(\text{mW}) = 6.0\text{ m}\Omega \times 7\text{ }A_{RMS}^2 = 294.0\text{ mW}$$

and as per:

$$\Delta T(\text{°C}) = P_{dis}(\text{mW}) / G(\text{mW/°C})$$

we have the following:

$$\Delta T(\text{°C}) = 294.0(\text{mW}) / 125(\text{mW/°C}) = 2.35\text{ °C}$$

What is below of the

$$\Delta T_{max}(95\text{ °C}) = (\text{Factor})^2 \times \Delta T(85\text{ °C}) = (0.5)^2 \times 15\text{ °C} = 3.8\text{ °C}$$

On the other hand we may confirm that max I_{RMS} at 10 kHz at 85 °C = 15.2 A_{RMS}

And then max I_{RMS} for 95 °C of ambient temperature is defined as follows:

$$I_{RMS}(95\text{ °C}) = \text{Factor} \times I_{RMS}(85\text{ °C}) = 0.5 \times 15.2\text{ }A_{RMS} = 7.6\text{ }A_{RMS}.$$

What confirms once again that $I_{RMS}(7\text{ }A_{RMS}$ at 10 kHz) is below the max specified for such frequency and ambient temperature.

Film Capacitor
Metallized polypropylene Film Capacitor **B32714H ... B32718H**

Service life:

Life time expectancy – typical curves

(500 V DC / 600 V DC / 800 V DC / 900 V DC / 1000 V DC / 1100 V DC / 1200 V DC / 1400 V DC / 1500 V DC / 1600 V DC / B3271x-H/5/6/8/9/0/1/2/4/7/3)

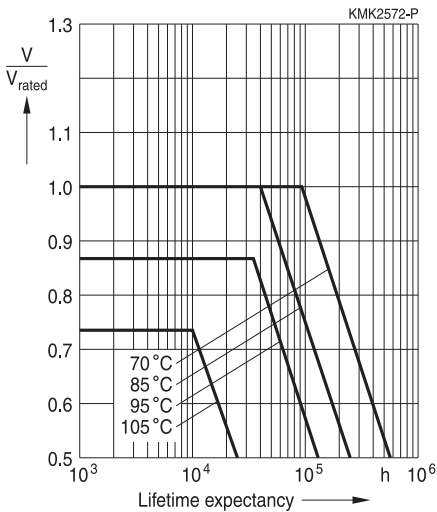

Note: Confidence level of 98%.

Film Capacitor
Metallized polypropylene Film Capacitor
B32714H ... B32718H
Testing and Standards

Test	Reference	Conditions of test	Performance requirements
Electrical parameters (Routine test)	IEC61071:2007	Voltage between terminals, $1.5 \cdot V_R$, during 10 s Insulation resistance, R_{INS} at 500 V, Capacitance, C at 1 kHz (room temperature) Dissipation factor, $\tan \delta$ at 1/10 kHz (room temperature)	Within specified limits
Robustness of terminations (Type test)	IEC 60068-2-21:2006	Tensile strength (test Ua1) Wire diameter Tensile force $0.5 < d_1 \leq 0.8$ mm 10 N $0.8 < d_1 \leq 1.25$ mm 20 N	Capacitance and $\tan \delta$ within specified limits
Resistance to soldering heat (Type test)	IEC 60068-2-20:2008, test Tb, method 1A	Solder bath temperature at 260 ± 5 °C, immersion for 10 seconds	$\Delta C/C_0 \leq 2\%$ $ \Delta \tan \delta \leq 0.002$ $R_{INS} \geq 50\%$ of initial limit Mechanical: No visible damage
Rapid change of temperature (Type test)	IEC 61071:2007	T_A = lower category temperature T_B = upper category temperature Five cycles, duration $t = 30$ min	$\Delta C/C_0 \leq 2\%$ $ \Delta \tan \delta \leq 0.002$ $R_{INS} \geq 50\%$ of initial limit Mechanical: No visible damage
Vibration and shocks (Type test)	IEC 61071:2007	In accordance with IEC 60068-2-6 $f = 10$ Hz to 55 Hz $a = \pm 0.35$ mm Test duration per axis = 10 frequency cycles (3 axes offset from each other by 90°), 1 octave/min. Mounting conditions: The capacitor shall be fixed by the leads and the body must be properly clamped.	Electrical: $ \Delta C/C_0 \leq 0.5\%$ at 1 kHz Mechanical: No visible damage

Film Capacitor
Metallized polypropylene Film Capacitor
B32714H ... B32718H

Test	Reference	Conditions of test	Performance requirements
Self-healing	IEC 61071:2007	1.5 x UNDC Duration 10 s Number of clearings ≤ 5 Clearing = voltage drop of 5% increase the voltage at 100 V/s till 5 clearings occur with a max. of $2.5 \cdot V_R$ for a duration of 10 s	$ \Delta C/C_0 \leq 0.5\%$ $\tan \delta$ (10 kHz) ≤ 1.2 initial $\tan \delta + 0.0001$
Climatic sequence (Type test)	IEC 60384-16:2005	Dry heat Tb / 16 h Damp heat cyclic, 1 st cycle +55 °C / 24 h / 95% ... 100% RH Cold Ta / 2 h Damp heat cyclic, 5 cycles +55 °C / 24 h / 95% ... 100% RH	No visible damage $ \Delta C/C_0 \leq 3\%$ $ \Delta \tan \delta \leq 0.001$ $R_{INS} \geq 50\%$ of initial limit
Blased humidity test (Type test)		60 °C / 95% RH / V_R 1000 h	No visible damage $ \Delta C/C_0 \leq 3\%$ $ \Delta \tan \delta \leq 0.005$ (1 kHz) $R_{INS} \geq 50\%$ of initial limit
Endurance (Type test)	IEC 61071:2007	+85 °C / $1.3 V_R$ / 500 hours and 1000 discharges at $1.4 I_P$ and +85 °C / $1.3 V_R$ / 500 hours	No visible damage $ \Delta C/C_0 \leq 3\%$ $ \Delta \tan \delta \leq 0.005$ (1 kHz) $R_{INS} \geq 50\%$ of initial limit Mechanical: No visible damage

Film Capacitor
Metallized polypropylene Film Capacitor
B32714H ... B32718H
Mounting guidelines
1 Soldering
1.1 Solderability of leads

The solderability of terminal leads is tested to IEC 60068-2-20:2008, test Ta, method 1.

Before a solderability test is carried out, terminals are subjected to accelerated ageing (to IEC 60068-2-2:2007, test Ba: 4 h exposure to dry heat at 155 °C). Since the ageing temperature is far higher than the upper category temperature of the capacitors, the terminal wires should be cut off from the capacitor before the ageing procedure to prevent the solderability being impaired by the products of any capacitor decomposition that might occur.

Solder bath temperature	235 ±5 °C
Soldering time	2.0 ±0.5 s
Immersion depth	2.0 +0/-0.5 mm from capacitor body or seating plane
Evaluation criteria:	
Visual inspection	Wetting of wire surface by new solder ≥90%, free-flowing solder

1.2 Resistance to soldering heat

Resistance to soldering heat is tested to IEC 60068-2-20:2008, test Tb, method 1. Conditions:

Series		Solder bath temperature	Soldering time
MKT	boxed (except 2.5 × 6.5 × 7.2 mm) coated uncoated (lead spacing >10 mm)	260 ±5 °C	10 ±1 s
MFP MKP	(lead spacing >7.5 mm)		
MKT	boxed (case 2.5 × 6.5 × 7.2 mm)		5 ±1 s
MKP MKT	(lead spacing ≤7.5 mm) uncoated (lead spacing ≤10 mm) insulated (B32559)		<4 s recommended soldering profile for MKT uncoated (lead spacing ≤10 mm) and insulated (B32559)

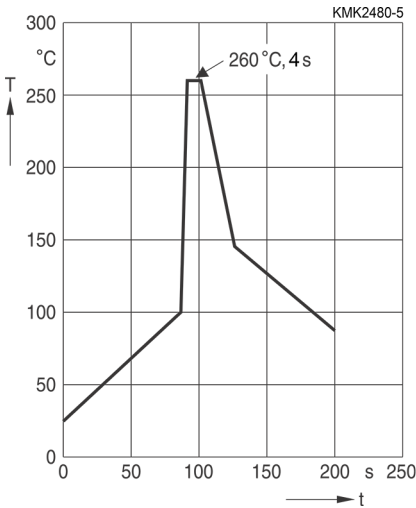
Film Capacitor
Metallized polypropylene Film Capacitor
B32714H ... B32718H

Immersion depth	2.0 +0/-0.5 mm from capacitor body or seating plane
Shield	Heat-absorbing board, (1.5 ±0.5) mm thick, between capacitor body and liquid solder
Evaluation criteria:	
Visual inspection	No visible damage
$\Delta C/C_0$	2% for MKT/MKP/MFP 5% for EMI suppression capacitors
$\tan \delta$	As specified in sectional specification

1.3 General notes on soldering

Permissible heat exposure loads on film capacitors are primarily characterized by the upper category temperature T_{max} . Long exposure to temperatures above this type-related temperature limit can lead to changes in the plastic dielectric and thus change irreversibly a capacitor's electrical characteristics. For short exposures (as in practical soldering processes) the heat load (and thus the possible effects on a capacitor) will also depend on other factors like:

- Pre-heating temperature and time
- Forced cooling immediately after soldering
- Terminal characteristics: diameter, length, thermal resistance, special configurations (e.g. crimping)
- Height of capacitor above solder bath
- Shadowing by neighboring components
- Additional heating due to heat dissipation by neighboring components
- Use of solder-resist coatings

Film Capacitor

Metallized polypropylene Film Capacitor

B32714H ... B32718H

The overheating associated with some of these factors can usually be reduced by suitable countermeasures. For example, if a pre-heating step cannot be avoided, an additional or reinforced cooling process may possibly have to be included.

Recommendations

As a reference, the recommended wave soldering profile for our film capacitors is as follows:

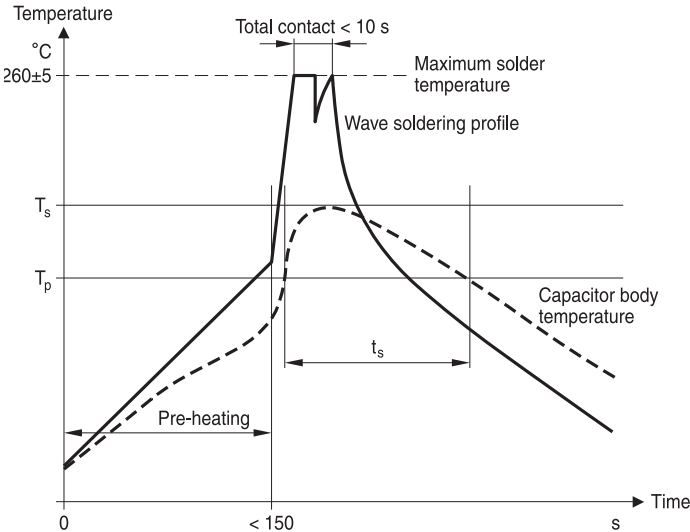

T_s: Capacitor body maximum temperature at wave soldering

T_p: Capacitor body maximum temperature at pre-heating

KMK1745-A-E

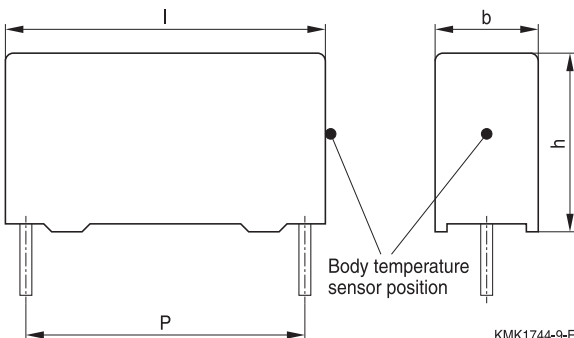

KMK1744-9-E

Film Capacitor

Metallized polypropylene Film Capacitor

B32714H ... B32718H

Body temperature should follow the description below:

- MKP capacitor
 - During pre-heating: $T_p \leq 110 \text{ }^\circ\text{C}$
 - During soldering: $T_s \leq 120 \text{ }^\circ\text{C}$, $t_s \leq 45 \text{ s}$
- MKT capacitor
 - During pre-heating: $T_p \leq 125 \text{ }^\circ\text{C}$
 - During soldering: $T_s \leq 160 \text{ }^\circ\text{C}$, $t_s \leq 45 \text{ s}$

When SMD components are used together with leaded ones, the film capacitors should not pass into the SMD adhesive curing oven. The leaded components should be assembled after the SMD curing step.

Leaded film capacitors are not suitable for reflow soldering.

In order to ensure proper conditions for manual or selective soldering, the body temperature of the capacitor (T_s) must be $\leq 120 \text{ }^\circ\text{C}$.

One recommended condition for manual soldering is that the tip of the soldering iron should be $< 360 \text{ }^\circ\text{C}$ and the soldering contact time should be no longer than 3 seconds.

For uncoated MKT capacitors with lead spacings $\leq 10 \text{ mm}$ (B32560/B32561) the following measures are recommended:

- pre-heating to not more than $110 \text{ }^\circ\text{C}$ in the preheater phase
- rapid cooling after soldering

Please refer to our Film Capacitors Data Book in case more details are needed.

Film Capacitor
Metallized polypropylene Film Capacitor
B32714H ... B32718H
Cleaning

To determine whether the following solvents, often used to remove flux residues and other substances, are suitable for the capacitors described, refer to the table below:

Type	Ethanol, isopropanol, n-propanol	n-propanol-water mixtures, water with surface tension-reducing tensides (neutral)
MKT (uncoated)	Suitable	Unsuitable
MKT, MKP, MFP (coated/boxed)		Suitable

Even when suitable solvents are used, a reversible change of the electrical characteristics may occur in uncoated capacitors immediately after they are washed. Thus it is always recommended to dry the components (e.g. 4 h at 70 °C) before they are subjected to subsequent electrical testing.

Caution: Consult us first if you wish to embed uncoated types!

Embedding of capacitors in finished assemblies

In many applications, finished circuit assemblies are embedded in plastic resins. In this case, both chemical and thermal influences of the embedding ("potting") and curing processes must be taken into account.

Our experience has shown that the following potting materials can be recommended: non-flexible epoxy resins with acid-anhydride hardeners; chemically inert, non-conducting fillers; maximum curing temperature of 100 °C.





Caution: Consult us first if you wish to embed uncoated types!

Film Capacitor
Metallized polypropylene Film Capacitor
B32714H ... B32718H
Marking
1 Capacitor markings

Depending on the capacitor size, the markings are positioned either on the side and/or the top of the component. The coded forms specified in IEC 60062:2004 are used to indicate the rated capacitance, capacitance tolerance and date of manufacture.

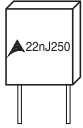
The lot number (production batch number) ensures unique identification of a particular capacitor and allows, together with the date of manufacture, exact assignment to the process data of the entire production run (traceability).

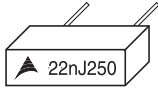
Marking examples
Boxed capacitors (without EMI suppression capacitors)

Style	Lead spacing	Marking example	Marking
MKT	5 mm	Version 1  KMK1739-4	Side stamping: Manufacturer's logo, C_R , tolerance, V_R
		Version 2  KMK0994-V-E	Side stamping: C_R , tolerance, V_R , manufacturer's logo, coded type "1", date of manufacture (year and month coded)
		Version 3  KMK0995-4-E	Top stamping: Manufacturer's logo, C_R , tolerance, V_R
	7.5 mm	Version 1  KMK0995-4-E	Top stamping: Manufacturer's logo, C_R , tolerance, V_R
		Version 2  KMK0994-V-E	Side stamping: C_R , tolerance, V_R , manufacturer's logo, coded type "1", date of manufacture (year and month coded)

Film Capacitor
Metallized polypropylene Film Capacitor
B32714H ... B32718H

Style	Lead spacing	Marking example	Marking
MKT MKP	10 mm		Manufacturer's logo 1st line: Lot number (1 character, 9 digits), series number (film material is coded in the series number) 2nd line: C_R , tolerance, V_R (DC or AC), date of manufacture (year and moth coded)
MKT MKP MFP	15 ... 37.5 mm	Version 1 	Manufacturer's logo 1st line: Lot number (1 character, 9 digits), series number (film material is coded in the series number) 2nd line: C_R , tolerance, V_R (DC or AC), date of manufacture (year and moth coded)
		Version 2 	Manufacturer's logo 1st line: Series number, film material (MKP or MFP) 2nd line: C_R , tolerance, V_R (DC or AC) Vertical: Date of manufacture (year and moth coded)
		Version 3 	Manufacturer's logo 1st line: Lot number, series number 2nd line: C_R , tolerance, V_R (DC or AC), date of manufacture (year and moth coded)
MKP	52.5 mm	Version 1 	Manufacturer's logo 1st line: Series number, film material (MKP or MFP) 2nd line: C_R , tolerance, V_R (DC or AC) Vertical: Date of manufacture (year and moth coded)
		Version 2 	Manufacturer's logo 1st line: Lot number, series number 2nd line: C_R , tolerance, V_R (DC or AC), date of manufacture (year and moth coded)

**Marking examples
SilverCap™ capacitors**

Style	Lead spacing	Marking example	Marking
MKT	7.5 ... 27.5 mm		1st line: C_R 2nd line: V_R

Film Capacitor
Metallized polypropylene Film Capacitor
B32714H ... B32718H
Code for rated capacitance

Rated capacitance	To IEC 60062	Short code
100 pF	100p	n1
150 pF	150p	n15
1.0 nF	1n0	1n
1.5 nF	1n5	
10 nF	10n	
100 nF	100n	μ1
150 nF	150n	μ15
1.0 μF	1μ0	1μ
1.5 μF	1μ5	
10 μF	10μ	
15 μF	15μ	

Codes for capacitance tolerance

Cap. tolerance	Code letter	Remark
	A	Capacitors tolerances for which no code letter is defined can be indicated by an A. The meaning of code A must then be mutually specified in other documentation.
±2.5%	H	
±5%	J	
±10%	K	
±20%	M	

Codes for date of manufacture (to IED 60062:2004)

Code for year				Code for month			
Year	Code letter	Year	Code letter	Month	Code numeral	Month	Code numeral/letter
2012	C	2018	K	January	1	July	7
2013	D	2019	L	February	2	August	8
2014	E	2020	M	March	3	September	9
2015	F	2021	N	April	4	October	O
2016	H	2022	P	May	5	November	N
2017	J	2023	R	June	6	December	D

E.g.: J5 2017 May

Marking types

The capacitors may have either an ink-jet marking or a laser marking. The main advantage of laser marking is that it cannot be removed by solvents, which ensures the reliable identification of the capacitor. Moreover, because the laser marking process reduces the amount of chemicals used, it is an environmentally friendly marking solution.

Film Capacitor
Metallized polypropylene Film Capacitor
B32714H ... B32718H
Cautions and warnings

- Do not exceed the upper category temperature (UCT).
- Do not apply any mechanical stress to the capacitor terminals.
- Avoid any compressive, tensile or flexural stress.
- Do not move the capacitor after it has been soldered to the PC board.
- Do not pick up the PC board by the soldered capacitor.
- Do not place the capacitor on a PC board whose PTH hole spacing differs from the specified lead spacing.
- Do not exceed the specified time or temperature limits during soldering.
- Avoid external energy inputs, such as fire or electricity.
- Avoid overload of the capacitors.
- Consult us if application is with severe temperature and humidity condition.
- There are no serviceable or repairable parts inside the capacitor. Opening the capacitor or any attempts to open or repair the capacitor will void the warranty and liability of TDK Electronics.
- Please note that the standards referred to in this publication may have been revised in the meantime.

The table below summarizes the safety instructions that must always be observed. A detailed description can be found in the relevant sections of the chapters "General technical information" and "Mounting guidelines".

Topic	Safety information	Reference chapter "General technical information"
Storage conditions	Make sure that capacitors are stored within the specified range of time, temperature and humidity conditions.	4.5 "Storage conditions"
Flammability	Avoid external energy, such as fire or electricity (passive flammability), avoid overload of the capacitors (active flammability) and consider the flammability of materials.	5.3 "Flammability"
Resistance to vibration	Do not exceed the tested ability to withstand vibration. The capacitors are tested to IEC 60068-2-6:2007. TDK Electronics offers film capacitors specially designed for operation under more severe vibration regimes such as those found in automotive applications. Consult our catalog "Film Capacitors for Automotive Electronics".	5.2 "Resistance to vibration"
Soldering	Do not exceed the specified time or temperature limits during soldering.	1 "Soldering"
Cleaning	Use only suitable solvents for cleaning capacitors.	2 "Cleaning"
Embedding of capacitors in finished assemblies	When embedding finished circuit assemblies in plastic resins, chemical and thermal influences must be taken into account. Caution: Consult us first, if you also wish to embed other uncoated component types!	3 "Embedding of capacitors in finished assemblies"

Display of ordering codes for TDK Electronics products

The ordering code for one and the same product can be represented differently in data sheets, data books, other publications, on the company website, or in order-related documents such as shipping notes, order confirmations and product labels. The varying representations of the ordering codes are due to different processes employed and do not affect the specifications of the respective products.

Detailed information can be found on the Internet under www.tdk-electronics.tdk.com/orderingcodes.

Correlation of data sheet values and modelling tool outputs

Data sheet values and results of design tools may deviate as they have not been derived in the same context.

While data sheets show individual parameter statements without considering a possible dependency to other parameters. Tools model a complete given scenario as input and processed inside the tool.

Furthermore as we constantly strive to improve our models, the results of tools can change over time and be a non-binding indication only.

Symbols and terms

Symbol	English	German
α	Heat transfer coefficient	Wärmeübergangszahl
α_C	Temperature coefficient of capacitance	Temperaturkoeffizient der Kapazität
A	Capacitor surface area	Kondensatoroberfläche
β_C	Humidity coefficient of capacitance	Feuchtekoeffizient der Kapazität
C	Capacitance	Kapazität
C_R	Rated capacitance	Nennkapazität
ΔC	Absolute capacitance change	Absolute Kapazitätsänderung
$\Delta C/C$	Relative capacitance change (relative deviation of actual value)	Relative Kapazitätsänderung (relative Abweichung vom Ist-Wert)
$\Delta C/C_R$	Capacitance tolerance (relative deviation from rated capacitance)	Kapazitätstoleranz (relative Abweichung vom Nennwert)
dt	Time differential	Differentielle Zeit
Δt	Time interval	Zeitintervall
ΔT	Absolute temperature change (self-heating)	Absolute Temperaturänderung (Selbsterwärmung)
$\Delta \tan \delta$	Absolute change of dissipation factor	Absolute Änderung des Verlustfaktors
ΔV	Absolute voltage change	Absolute Spannungsänderung
dV/dt	Time differential of voltage function (rate of voltage rise)	Differentielle Spannungsänderung (Spannungsflankensteilheit)
$\Delta V/\Delta t$	Voltage change per time interval	Spannungsänderung pro Zeitintervall
E	Activation energy for diffusion	Aktivierungsenergie zur Diffusion
ESL	Self-inductance	Eigeninduktivität
ESR	Equivalent series resistance	Ersatz-Serienwiderstand
f	Frequency	Frequenz
f_1	Frequency limit for reducing permissible AC voltage due to thermal limits	Grenzfrequenz für thermisch bedingte Reduzierung der zulässigen Wechsel- spannung
f_2	Frequency limit for reducing permissible AC voltage due to current limit	Grenzfrequenz für strombedingte Redu- zierung der zulässigen Wechselspannung
f_r	Resonant frequency	Resonanzfrequenz
F_D	Thermal acceleration factor for diffusion	Therm. Beschleunigungsfaktor zur Diffusion
F_T	Derating factor	Deratingfaktor
i	Current (peak)	Stromspitze
I_C	Category current (max. continuous current)	Kategoriestrom (max. Dauerstrom)
I_{RMS}	(Sinusoidal) alternating current, root-mean- square value	(Sinusförmiger) Wechselstrom
i_z	Capacitance drift	Inkonstanz der Kapazität
k_0	Pulse characteristic	Impuls Kennwert
L_S	Series inductance	Serieninduktivität
λ	Failure rate	Ausfallrate
λ_0	Constant failure rate during useful service life	Konstante Ausfallrate in der Nutzungsphase

Film Capacitor
Metallized polypropylene Film Capacitor
B32714H ... B32718H

Symbol	English	German
λ_{test}	Failure rate, determined by tests	Experimentell ermittelte Ausfallrate
P_{diss}	Dissipated power	Abgegebene Verlustleistung
P_{gen}	Generated power	Erzeugte Verlustleistung
Q	Heat energy	Wärmeenergie
ρ	Density of water vapor in air	Dichte von Wasserdampf in Luft
R	Universal molar constant for gases	Allg. Molarkonstante für Gas
R	Ohmic resistance of discharge circuit	Ohmscher Widerstand des Entladekreises
R_i	Internal resistance	Innenwiderstand
R_{ins}	Insulation resistance	Isolationswiderstand
R_P	Parallel resistance	Parallelwiderstand
R_S	Series resistance	Serienwiderstand
S	severity (humidity test)	Schärfegrad (Feuchtetest)
t	Time	Zeit
T	Temperature	Temperatur
τ	Time constant	Zeitkonstante
$\tan \delta$	Dissipation factor	Verlustfaktor
$\tan \delta_D$	Dielectric component of dissipation factor	Dielektrischer Anteil des Verlustfaktors
$\tan \delta_P$	Parallel component of dissipation factor	Parallelanteil des Verlustfaktors
$\tan \delta_S$	Series component of dissipation factor	Serienanteil des Verlustfaktors
T_A	Temperature of the air surrounding the component	Temperatur der Luft, die das Bauteil umgibt
T_{max}	Upper category temperature	Obere Kategorietemperatur
T_{min}	Lower category temperature	Untere Kategorietemperatur
t_{OL}	Operating life at operating temperature and voltage	Betriebszeit bei Betriebstemperatur und -spannung
T_{op}	Operating temperature, $T_A + \Delta T$	Betriebstemperatur, $T_A + \Delta T$
T_R	Rated temperature	Nenntemperatur
T_{ref}	Reference temperature	Referenztemperatur
t_{SL}	Reference service life	Referenz-Lebensdauer
V_{AC}	AC voltage	Wechselspannung
V_C	Category voltage	Kategoriespannung
$V_{\text{C,RMS}}$	Category AC voltage	(Sinusförmige) Kategorie-Wechselspannung
V_{CD}	Corona-discharge onset voltage	Teilentlade-Einsatzspannung
V_{ch}	Charging voltage	Ladespannung
V_{DC}	DC voltage	Gleichspannung
V_{FB}	Fly-back capacitor voltage	Spannung (Flyback)
V_i	Input voltage	Eingangsspannung
V_o	Output voltage	Ausgangssspannung
V_{op}	Operating voltage	Betriebsspannung
V_p	Peak pulse voltage	Impuls-Spitzenspannung
V_{pp}	Peak-to-peak voltage Impedance	Spannungshub

Film Capacitor
Metallized polypropylene Film Capacitor
B32714H ... B32718H

Symbol	English	German
V_R	Rated voltage	Nennspannung
\hat{V}_R	Amplitude of rated AC voltage	Amplitude der Nenn-Wechselspannung
V_{RMS}	(Sinusoidal) alternating voltage, root-mean-square value	(Sinusförmige) Wechselspannung
V_{SC}	S-correction voltage	Spannung bei Anwendung "S-correction"
V_{sn}	Snubber capacitor voltage	Spannung bei Anwendung "Beschaltung"
Z	Impedance	Scheinwiderstand
e	Lead spacing	Rastermaß

Important notes

The following applies to all products named in this publication:

1. Some parts of this publication contain **statements about the suitability of our products for certain areas of application**. These statements are based on our knowledge of typical requirements that are often placed on our products in the areas of application concerned. We nevertheless expressly point out **that such statements cannot be regarded as binding statements about the suitability of our products for a particular customer application**. As a rule, we are either unfamiliar with individual customer applications or less familiar with them than the customers themselves. For these reasons, it is always ultimately incumbent on the customer to check and decide whether a product with the properties described in the product specification is suitable for use in a particular customer application.
2. We also point out that **in individual cases, a malfunction of electronic components or failure before the end of their usual service life cannot be completely ruled out in the current state of the art, even if they are operated as specified**. In customer applications requiring a very high level of operational safety and especially in customer applications in which the malfunction or failure of an electronic component could endanger human life or health (e.g. in accident prevention or life-saving systems), it must therefore be ensured by means of suitable design of the customer application or other action taken by the customer (e.g. installation of protective circuitry or redundancy) that no injury or damage is sustained by third parties in the event of malfunction or failure of an electronic component.
3. **The warnings, cautions and product-specific notes must be observed.**
4. In order to satisfy certain technical requirements, **some of the products described in this publication may contain substances subject to restrictions in certain jurisdictions (e.g. because they are classed as hazardous)**. Useful information on this will be found in our Material Data Sheets on the Internet (www.tdk-electronics.tdk.com/material). Should you have any more detailed questions, please contact our sales offices.
5. We constantly strive to improve our products. Consequently, **the products described in this publication may change from time to time**. The same is true of the corresponding product specifications. Please check therefore to what extent product descriptions and specifications contained in this publication are still applicable before or when you place an order.
We also **reserve the right to discontinue production and delivery of products**. Consequently, we cannot guarantee that all products named in this publication will always be available. The aforementioned does not apply in the case of individual agreements deviating from the foregoing for customer-specific products.
6. Unless otherwise agreed in individual contracts, **all orders are subject to our General Terms and Conditions of Supply**.



Important notes

7. **Our manufacturing sites serving the automotive business apply the IATF 16949 standard.**
The IATF certifications confirm our compliance with requirements regarding the quality management system in the automotive industry. Referring to customer requirements and customer specific requirements (“CSR”) TDK always has and will continue to have the policy of respecting individual agreements. Even if IATF 16949 may appear to support the acceptance of unilateral requirements, we hereby like to emphasize that **only requirements mutually agreed upon can and will be implemented in our Quality Management System.** For clarification purposes we like to point out that obligations from IATF 16949 shall only become legally binding if individually agreed upon.
8. The trade names EPCOS, CarXield, CeraCharge, CeraDiode, CeraLink, CeraPad, CeraPlas, CSMP, CTVS, DeltaCap, DigiSiMic, ExoCore, FilterCap, FormFit, LeaXield, MiniBlue, MiniCell, MKD, MKK, ModCap, MotorCap, PCC, PhaseCap, PhaseCube, PhaseMod, PhiCap, PowerHap, PQSine, PQvar, SIFERRIT, SIFI, SIKOREL, SilverCap, SIMDAD, SiMic, SIMID, SineFormer, SIOV, ThermoFuse, WindCap, XieldCap are **trademarks registered or pending** in Europe and in other countries. Further information will be found on the Internet at www.tdk-electronics.tdk.com/trademarks.





Release 2020-06

Looking for pricing, stock, or lifecycle information?

Click below to explore more details on WIN SOURCE:

-  [View B32716H6506K000 on WIN SOURCE](#)
-  [EPCOS \(TDK\) Information](#)

Optimize Your Supply Chain with WIN SOURCE Solutions

-  Global Sourcing Solution
-  Obsolete Management
-  Cost Control Management
-  Shortage Management
-  Alternative Solution
-  Excess Inventory Management