

DATA SHEET

SURFACE MOUNT MULTILAYER CERAMIC CAPACITORS

General purpose & High capacitance

Class 2, X5R

4 V TO 50 V

100 pF to 220 μ F

RoHS compliant & Halogen free



SCOPE

This specification describes X5R series chip capacitors with lead-free terminations.

APPLICATIONS

PCs, Hard disk, Game PCs
Power supplies
DVD players
Mobile phones
Data processing

FEATURES

Supplied in tape on reel
Nickel-barrier end termination
RoHS compliant
Halogen free compliant

ORDERING INFORMATION - GLOBAL PART NUMBER, PHYCOMP CTC & I2NC

All part numbers are identified by the series, size, tolerance, TC material, packing style, voltage, process code, termination and capacitance value.

YAGEO BRAND ordering code

GLOBAL PART NUMBER (PREFERRED)

CC XXXX X X **X5R** X **BB** XXX
(1) (2) (3) (4) (5)

(1) SIZE – INCH BASED (METRIC)

0201 (0603)
0402 (1005)
0603 (1608)
0805 (2012)
1206 (3216)
1210 (3225)

(2) TOLERANCE

K = ±10%
M = ±20%

(3) PACKING STYLE

R = Paper/PE taping reel; Reel 7 inch
K = Blister taping reel; Reel 7 inch
P = Paper/PE taping reel; Reel 13 inch
F = Blister taping reel; Reel 13 inch
C = Bulk case

(4) RATED VOLTAGE

4 = 4 V
5 = 6.3 V
6 = 10 V
7 = 16 V
8 = 25 V
9 = 50 V

(5) CAPACITANCE VALUE

2 significant digits+number of zeros
The 3rd digit signifies the multiplying factor, and letter R is decimal point
Example: 103 = 10 × 10³ = 10,000 pF = 10 nF

CONSTRUCTION

The capacitor consists of a rectangular block of ceramic dielectric in which a number of interleaved metal electrodes are contained. This structure gives rise to a high capacitance per unit volume.

The inner electrodes are connected to the two end terminations and finally covered with a layer of plated tin (NiSn). The terminations are lead-free. A cross section of the structure is shown in Fig.1.

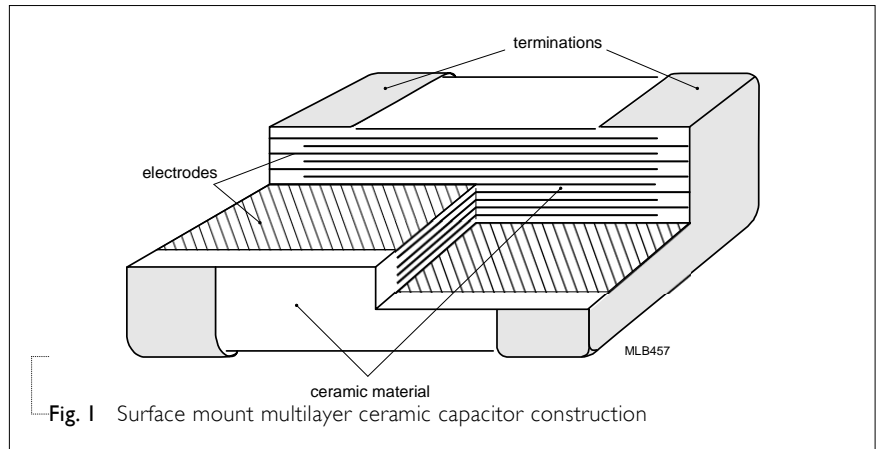

Fig. 1 Surface mount multilayer ceramic capacitor construction

DIMENSION

Table I For outlines see fig. 2

TYPE	L ₁ (mm)	W (mm)	T (mm)	L ₂ / L ₃ (mm)		L ₄ (mm)	DIMENSION CODE
				min.	max.	min.	
0201	0.6 ±0.03	0.3 ±0.03	0.3 ±0.03	0.1	0.2	0.2	BA
	0.6 ±0.05	0.3 ±0.05	0.3 ±0.05	0.1	0.2	0.2	BB
	0.6 ±0.09	0.3 ±0.09	0.3 ±0.09	0.1	0.25	0.2	BC
	0.6 ±0.15	0.3 ±0.15	0.3 ±0.15	0.1	0.25	0.2	BD
0402	1.0 ±0.05	0.5 ±0.05	0.5 ±0.05	0.15	0.35	0.3	CA
	1.0 ±0.10	0.5 ±0.10	0.5 ±0.10	0.15	0.35	0.3	CB
	1.0 ±0.15	0.5 ±0.15	0.5 ±0.15	0.15	0.35	0.3	CC
	1.0 ±0.20	0.5 ±0.20	0.5 ±0.20	0.15	0.35	0.3	CD
0603	1.6 ±0.10	0.8 ±0.10	0.8 ±0.10	0.2	0.6	0.4	DA
	1.6 ±0.15	0.8 ±0.15	0.8 ±0.15	0.2	0.6	0.4	DB
	1.6 ±0.20	0.8 ±0.20	0.8 ±0.20	0.2	0.6	0.4	DC
0805	2.0 ±0.20	1.25 ±0.20	0.85 ±0.10	0.25	0.75	0.7	EA
	2.0 ±0.20	1.25 ±0.20	1.25 ±0.20	0.25	0.75	0.7	EB
1206	3.2 ±0.20	1.6 ±0.20	1.15 ±0.10	0.25	0.75	1.4	FA
	3.2 ±0.30	1.6 ±0.20	1.25 ±0.20	0.25	0.75	1.4	FB
	3.2 ±0.30	1.6 ±0.30	1.60 ±0.20	0.25	0.80	1.4	FC
	3.2 ±0.30	1.6 ±0.30	1.60 ±0.30	0.30	0.90	1.4	FD
1210	3.2 ±0.40	2.5 ±0.30	1.25 ±0.20	0.25	0.75	1.4	GA
	3.2 ±0.40	2.5 ±0.30	1.90 ±0.20	0.25	0.75	1.4	GB
	3.2 ±0.40	2.5 ±0.30	2.5 ±0.20	0.25	0.75	1.0	GC
	3.2 ±0.40	2.5 ±0.30	2.5 ±0.30	0.25	0.75	1.0	GD

OUTLINES

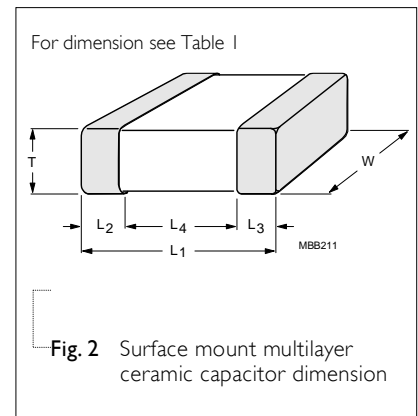

Fig. 2 Surface mount multilayer ceramic capacitor dimension

CAPACITANCE RANGE & THICKNESS FOR X5R

Table 2 Sizes from 0201 to 0402

CAP.	0201						0402					
	4 V	6.3 V	10 V	16 V	25 V	50 V	4 V	6.3 V	10 V	16 V	25 V	50 V
100 pF		BA	BA	BA	BA	BA						
150 pF		BA	BA	BA	BA	BA						
220 pF		BA	BA	BA	BA	BA						
330 pF		BA	BA	BA	BA	BA						
470 pF		BA	BA	BA	BA	BA						
680 pF		BA	BA	BA	BA	BA						
1.0 nF		BA	BA	BA	BA	BA						
1.5 nF		BA	BA	BA	BA							
2.2 nF		BA	BA	BA	BA							
3.3 nF		BA	BA	BA	BA							
4.7 nF		BA	BA	BA	BA							
6.8 nF		BA	BA	BA	BA							
10 nF		BA	BA	BA	BA							
15 nF		BA	BA	BA								

NOTE

1. Values in shaded cells indicate thickness class in mm
2. Capacitance value of non E-6 series is available on request

DIMENSION

Table 3

TYPE	L ₁ (mm)	W (mm)	T (mm)	L ₂ / L ₃ (mm)		L ₄ (mm)	DIMENSION CODE
				min.	max.	min.	
0201	0.6 ±0.03	0.3 ±0.03	0.3 ±0.03	0.1	0.2	0.2	BA
	0.6 ±0.05	0.3 ±0.05	0.3 ±0.05	0.1	0.2	0.2	BB
	0.6 ±0.09	0.3 ±0.09	0.3 ±0.09	0.1	0.25	0.2	BC
	0.6 ±0.15	0.3 ±0.15	0.3 ±0.15	0.1	0.25	0.2	BD
0402	1.0 ±0.05	0.5 ±0.05	0.5 ±0.05	0.15	0.35	0.3	CA
	1.0 ±0.10	0.5 ±0.10	0.5 ±0.10	0.15	0.35	0.3	CB
	1.0 ±0.15	0.5 ±0.15	0.5 ±0.15	0.15	0.35	0.3	CC
	1.0 ±0.20	0.5 ±0.20	0.5 ±0.20	0.15	0.35	0.3	CD

CAPACITANCE RANGE & THICKNESS FOR X5R

Table 4 Sizes from 0201 to 0402

CAP.	0201						0402					
	4 V	6.3 V	10 V	16 V	25 V	50 V	4 V	6.3 V	10 V	16 V	25 V	50 V
22 nF		BA	BA	BA	BA			CA	CA	CA	CA	CA
33 nF		BA	BA	BA	BA			CA	CA	CA	CA	CA
47 nF		BA	BA	BA	BA			CA	CA	CA	CA	CA
68 nF		BA	BA	BA				CA	CA	CA	CA	CA
100 nF		BA	BA	BA	BA			CA	CA	CA	CA	CA
150 nF								CA	CA	CA	CA	CA
220 nF	BA	BA	BA	BA	BA			CA	CA	CA	CA	CA
330 nF		BA	BC	BC				CA	CA	CA	CA	CA
470 nF	BA	BA	BC	BC				CA	CA	CB	CB	CB
680 nF								CA	CA	CA	CA	
1.0 µF	BB	BB	BB BC					CA	CA	CA	CA	CD
2.2 µF	BC	BC	BC					CA	CA	CA	CD	CD
4.7 µF	BD							CC	CC	CC	CC	
10 µF								CD	CD	CD		
22 µF								CD	CD			

NOTE

1. Values in shaded cells indicate thickness class in mm
2. Capacitance value of non E-6 series is available on request

DIMENSION

Table 5

TYPE	L ₁ (mm)	W (mm)	T (mm)	L ₂ / L ₃ (mm)		L ₄ (mm)	DIMENSION CODE
				min.	max.	min.	
0201	0.6 ±0.03	0.3 ±0.03	0.3 ±0.03	0.1	0.2	0.2	BA
	0.6 ±0.05	0.3 ±0.05	0.3 ±0.05	0.1	0.2	0.2	BB
	0.6 ±0.09	0.3 ±0.09	0.3 ±0.09	0.1	0.25	0.2	BC
	0.6 ±0.15	0.3 ±0.15	0.3 ±0.15	0.1	0.25	0.2	BD
0402	1.0 ±0.05	0.5 ±0.05	0.5 ±0.05	0.15	0.35	0.3	CA
	1.0 ±0.10	0.5 ±0.10	0.5 ±0.10	0.15	0.35	0.3	CB
	1.0 ±0.15	0.5 ±0.15	0.5 ±0.15	0.15	0.35	0.3	CC
	1.0 ±0.20	0.5 ±0.20	0.5 ±0.20	0.15	0.35	0.3	CD

CAPACITANCE RANGE & THICKNESS FOR X5R

Table 6 Sizes from 0603 to 0805

CAP.	0603						0805					
	4V	6.3 V	10 V	16 V	25 V	50V	4V	6.3 V	10 V	16 V	25 V	50V
10 nF												
15 nF												
22 nF												
33 nF												
47nF												
68 nF												
100 nF												
150 nF												
220 nF		DA	DA	DA	DA	DA						
330 nF		DA	DA	DA	DA	DA						
470 nF		DA	DA	DA	DA	DA		EA EB	EA EB	EA EB	EB	EB
680 nF		DA	DA	DA	DA	DA		EA EB	EA EB	EA EB	EB	EB
1.0 µF		DA	DA	DA	DA	DA		EA EB	EA EB	EA EB	EB	EB
2.2 µF		DA	DA	DA	DB	DC		EA EB	EA EB	EA EB	EA EB	EB
4.7 µF		DA	DA	DB	DB			EA EB	EA EB	EB	EB	EB
10 µF		DB	DC	DC	DC			EA EB	EA EB	EA EB	EB	
22 µF		DC	DC					EB	EB	EB	EB	
47 µF	DC	DC						EB	EB			
100 µF												

NOTE

1. Values in shaded cells indicate thickness class in mm
2. Capacitance value of non E-6 series is available on request

DIMENSION

Table 7

TYPE	L ₁ (mm)	W (mm)	T (mm)	L ₂ / L ₃ (mm)		L ₄ (mm)	DIMENSION CODE
				min.	max.	min.	
0603	1.6 ±0.10	0.8 ±0.10	0.8 ±0.10	0.2	0.6	0.4	DA
	1.6 ±0.15	0.8 ±0.15	0.8 ±0.15	0.2	0.6	0.4	DB
	1.6 ±0.20	0.8 ±0.20	0.8 ±0.20	0.2	0.6	0.4	DC
0805	2.0 ±0.20	1.25 ±0.20	0.85 ±0.10	0.25	0.75	0.7	EA
	2.0 ±0.20	1.25 ±0.20	1.25 ±0.20	0.25	0.75	0.7	EB

CAPACITANCE RANGE & THICKNESS FOR X5R

Table 8 Sizes from I206 to I210

CAP.	I206					I210				
	6.3 V	10 V	16 V	25 V	50V	6.3 V	10 V	16 V	25 V	50V
10 nF										
15 nF										
22 nF										
33 nF										
47nF										
68 nF										
100 nF										
150 nF										
220 nF										
330 nF										
470 nF										
680 nF										
1.0 μF	FA	FA	FA	FA	FC	GA	GA	GA	GA	GA
2.2 μF	FA	FA	FA	FA	FC	GB	GB	GB	GB	GB
4.7 μF	FC	FC	FC	FC	FC	GB	GB	GB	GB	GC
10 μF	FC	FC	FC	FC	FD	GB	GB	GB	GB	GD
22 μF	FC	FC	FC	FD		GC	GC	GC	GD	
47 μF	FC	FC	FD			GC	GC	GC		
100 μF	FD					GD	GD	GD		
220 μF						GD				

NOTE

1. Values in shaded cells indicate thickness class in mm
2. Capacitance value of non E-6 series is available on request

DIMENSION

Table 9

TYPE	L ₁ (mm)	W (mm)	T (mm)	L ₂ / L ₃ (mm)		L ₄ (mm)	DIMENSION CODE
				min.	max.		
I206	3.2 ±0.20	1.6 ±0.20	1.15 ±0.10	0.25	0.75	1.4	FA
	3.2 ±0.30	1.6 ±0.20	1.25 ±0.20	0.25	0.75	1.4	FB
	3.2 ±0.30	1.6 ±0.30	1.60 ±0.20	0.25	0.80	1.4	FC
	3.2 ±0.30	1.6 ±0.30	1.60 ±0.30	0.30	0.90	1.4	FD
I210	3.2 ±0.40	2.5 ±0.30	1.25 ±0.20	0.25	0.75	1.4	GA
	3.2 ±0.40	2.5 ±0.30	1.90 ±0.20	0.25	0.75	1.4	GB
	3.2 ±0.40	2.5 ±0.30	2.5 ±0.20	0.25	0.75	1.0	GC
	3.2 ±0.40	2.5 ±0.30	2.5 ±0.30	0.25	0.75	1.0	GD

THICKNESS CLASSES AND PACKING QUANTITY

Table 10

SIZE CODE	THICKNESS CLASSIFICATION	TAPE WIDTH QUANTITY PER REEL	Ø180 MM / 7 INCH		Ø330 MM / 13 INCH		QUANTITY PER BULK CASE
			Paper	Blister	Paper	Blister	
0201	0.3 ±0.03 mm	8 mm	15,000	---	50,000	---	---
0402	0.5 ±0.05 / 0.1 mm	8 mm	10,000	---	50,000	---	50,000
	0.5 ±0.15 / 0.2 mm	8 mm	10,000	---	40,000	---	---
0603	0.8 ±0.1 / 0.2 mm	8 mm	4,000	---	15,000	---	15,000
0805	0.6 ±0.1 mm	8 mm	4,000	---	20,000	---	10,000
	0.85 ±0.1 mm	8 mm	4,000	---	15,000	---	8,000
	1.25 ±0.2 mm	8 mm	---	3,000	---	10,000	5,000
1206	0.6 ±0.1 mm	8 mm	4,000	---	20,000	---	---
	0.85 ±0.1 mm	8 mm	4,000	---	15,000	---	---
	1.00 / 1.15 ±0.1 mm	8 mm	---	3,000	---	10,000	---
	1.25 ±0.2 mm	8 mm	---	3,000	---	10,000	---
	1.6 ±0.15 mm	8 mm	---	2,500	---	10,000	---
	1.6 ±0.2 mm	8 mm	---	2,000	---	8,000	---
1210	0.6 / 0.7 ±0.1 mm	8 mm	---	4,000	---	15,000	---
	0.85 ±0.1 mm	8 mm	---	4,000	---	10,000	---
	1.15 ±0.1 mm	8 mm	---	3,000	---	10,000	---
	1.15 ±0.15 mm	8 mm	---	3,000	---	10,000	---
	1.25 ±0.2 mm	8 mm	---	3,000	---	---	---
	1.5 ±0.1 mm	8 mm	---	2,000	---	---	---
	1.6 / 1.9 ±0.2 mm	8 mm	---	2,000	---	---	---
	2.0 ±0.2 mm	8 mm	---	2,000 1,000	---	---	---
2.5 ±0.2 mm	8 mm	---	1,000 500	---	---	---	

ELECTRICAL CHARACTERISTICS

X5R DIELECTRIC CAPACITORS; NISN TERMINATIONS

Unless otherwise specified, all tests and measurements shall be made under standard atmospheric conditions for testing as given in 5.3 of IEC 60068-1:

- Temperature: 15 °C to 35 °C
- Relative humidity: 25% to 75%
- Air pressure: 86 kPa to 106 kPa

Before the measurements are made, the capacitor shall be stored at the measuring temperature for a time sufficient to allow the entire capacitor to reach this temperature.

The period as prescribed for recovery at the end of a test is normally sufficient for this purpose.

Table 11

DESCRIPTION							VALUE
Capacitance range							100 pF to 220 μF
Capacitance tolerance							±10% and ±20%
Dissipation factor (D.F.)							
X5R	0201	0402	0603	0805	1206	1210	D.F.
≤ 6.3V	100pF to 10nF	22nF to 100nF	220nF to 470nF	470nF to 680nF	1μF to 4.7μF	1μF to 10μF	≤ 5%
	680nF to 1μF						≤ 7%
	12nF to 1μF	120nF to 10μF	2.2μF to 47μF	1μF to 47μF	10μF to 47μF	22μF to 220μF	≤ 10%
	2.2μF				100μF		≤ 15%
	4.7μF	22μF		≤ 20%			
10V	100pF to 10nF	22nF to 100nF	220nF to 470nF	470nF to 680nF	1μF to 4.7μF	1μF to 4.7μF	≤ 5%
	680nF to 1μF						≤ 7%
	12nF to 220nF, 1μF	120nF to 10μF	2.2μF to 22μF	2.2μF to 47μF	10μF to 47μF	10μF to 100μF	≤ 10%
	470nF						≤ 15%
	2.2μF						≤ 20%
16V	100pF to 10nF	22nF to 100nF	220nF to 470nF	470nF to 680nF	1μF to 4.7μF	1μF to 4.7μF	≤ 5%
	680nF to 1μF				1 μF to 2.2μF		≤ 7%
	12nF to 220nF	120nF to 4.7μF	2.2μF to 10μF	4.7μF to 22μF	10μF to 22μF	10μF to 100μF	≤ 10%
	470nF						≤ 15%
	≤ 20%						
25V	100pF to 470pF	22nF		470nF to 1μF	1μF to 2.2μF	1μF to 4.7μF	≤ 3.5%
	560pF to 10nF	27nF to 100nF	220nF to 470nF	2.2μF	4.7μF	10μF	≤ 5%
	680nF to 1μF						≤ 7%
	22nF to 220nF	120nF to 2.2μF	2.2μF to 10μF	4.7μF to 22μF	10μF to 22μF	22μF	≤ 10%
	≤ 20%						
50V	100pF to 1nF	22nF		≤ 3.5%			
	27nF to 100nF						≤ 5%
	120nF to 1μF	220nF to 2.2μF	470nF to 4.7μF	1μF to 10μF	1μF to 10μF	≤ 10%	
Insulation resistance after 1 minute at Ur (DC)				$R_{ins} \geq 10 \text{ G}\Omega$ or $R_{ins} \times Cr \geq 50/100/500^*$ seconds whichever is less			
Maximum capacitance change as a function of temperature (temperature characteristic/coefficient):							±15%
Operating temperature range:							-55 °C to +85 °C

X5R	0201	0402	0603	0805	1206	1210	I.R.
≤ 6.3V	100pF to 82nF	22nF to 470nF	220nF to 1uF	470nF to 4.7uF	1uF to 2.2uF	1uF to 4.7uF	$R_{ins} \geq 10\text{ G}\Omega$ or $R_{ins} \times Cr \geq 500\Omega.F$
	100nF to 1uF	560nF to 4.7uF	2.2uF to 4.7uF	10uF	4.7uF to 47uF	10uF to 220uF	$R_{ins} \times Cr \geq 100\Omega.F$
		10uF	10uF to 22uF	22uF to 47uF	100uF		$R_{ins} \times Cr \geq 50\Omega.F$
	2.2uF to 4.7uF	22uF	47uF				$R_{ins} \times Cr \geq 20\Omega.F$
10V	100pF to 82nF	22nF to 470nF	220nF to 1uF	470nF to 2.2uF	1uF to 2.2uF	1uF to 4.7uF	$R_{ins} \geq 10\text{ G}\Omega$ or $R_{ins} \times Cr \geq 500\Omega.F$
	100nF to 470nF	560nF to 4.7uF	2.2uF to 4.7uF	4.7uF to 22uF	4.7uF to 47uF	10uF to 100uF	$R_{ins} \times Cr \geq 100\Omega.F$
	560nF to 2.2uF	10uF	10uF to 22uF	47uF			$R_{ins} \times Cr \geq 50\Omega.F$
16V	100pF to 10nF	22nF to 150nF	220nF to 1uF	470nF to 2.2uF	1uF to 2.2uF	1uF to 4.7uF	$R_{ins} \geq 10\text{ G}\Omega$ or $R_{ins} \times Cr \geq 500\Omega.F$
	22nF to 100nF, 470nF		2.2uF to 4.7uF	4.7uF to 22uF	4.7uF to 10uF	10uF to 100uF	$R_{ins} \times Cr \geq 100\Omega.F$
	220nF	220nF to 4.7uF	10uF		22uF		$R_{ins} \times Cr \geq 50\Omega.F$
25V	100pF to 10nF	22nF to 150nF	220nF to 1uF	470nF to 2.2uF	1uF to 2.2uF	1uF to 2.2uF	$R_{ins} \geq 10\text{ G}\Omega$ or $R_{ins} \times Cr \geq 500\Omega.F$
	22nF to 100nF		2.2uF to 4.7uF	4.7uF to 22uF	4.7uF	4.7uF to 22uF	$R_{ins} \times Cr \geq 100\Omega.F$
	220nF	220nF to 2.2uF	10uF		10uF, 22uF		$R_{ins} \times Cr \geq 50\Omega.F$
50V	100pF to 1nF	22nF to 100nF		470nF to 2.2uF	1uF to 2.2uF	1uF to 2.2uF	$R_{ins} \geq 10\text{ G}\Omega$ or $R_{ins} \times Cr \geq 500\Omega.F$
			220nF to 2.2uF	4.7uF	4.7uF	4.7uF to 10uF	$R_{ins} \times Cr \geq 100\Omega.F$
		150nF to 1uF			10uF		$R_{ins} \times Cr \geq 50\Omega.F$

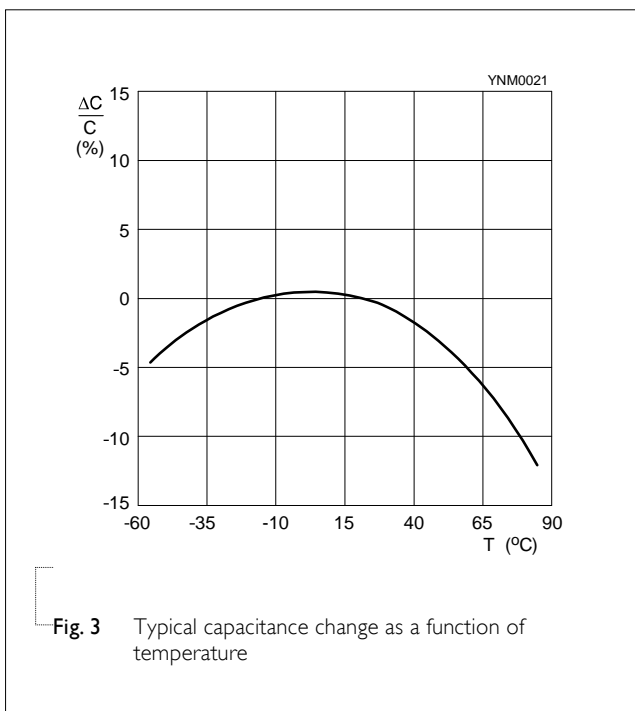

Size 0201 10 nF / 16 V
 Solid lines: Impedance / Dotted lines: ESR

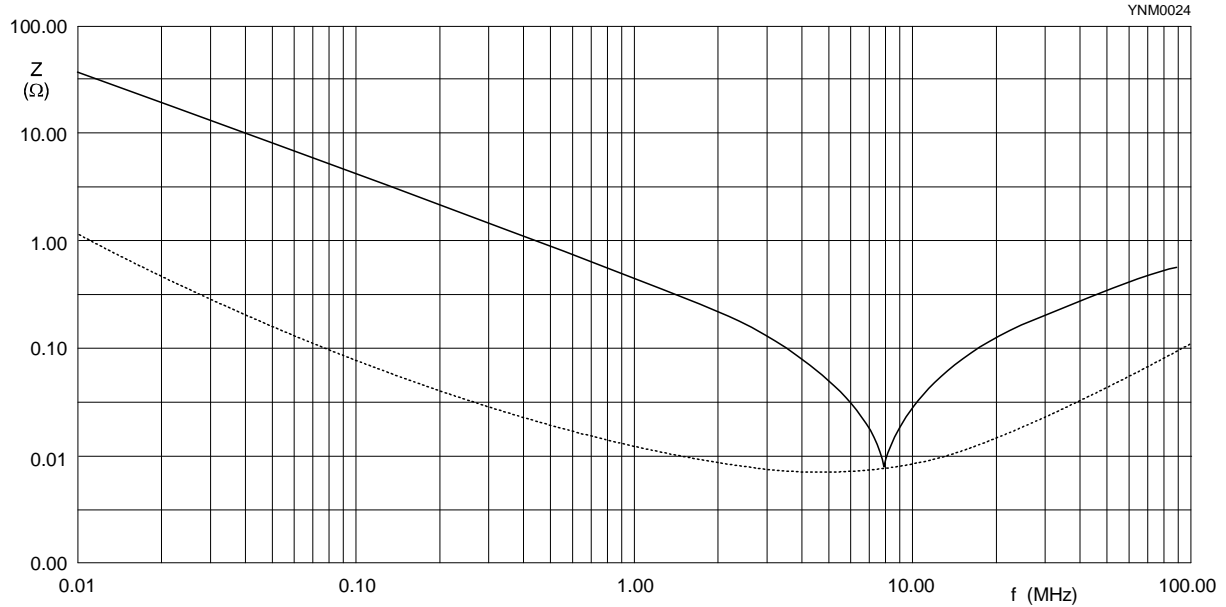

YNM0024

Fig. 4 Impedance ESR vs. frequency characteristics for multilayer chip capacitors

Size 0603 1 μF / 10 V
 Solid lines: Impedance / Dotted lines: ESR

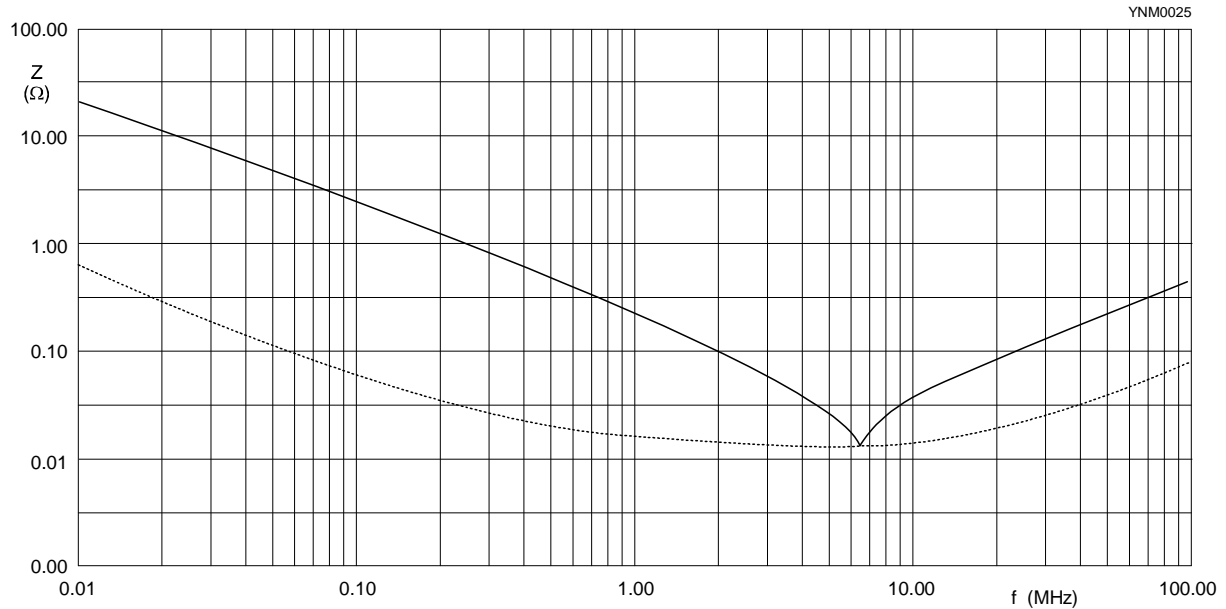

YNM0025

Fig. 5 Impedance ESR vs. frequency characteristics for multilayer chip capacitors

Size 0805 10 μ F / 6.3 V
Solid lines: Impedance / Dotted lines: ESR

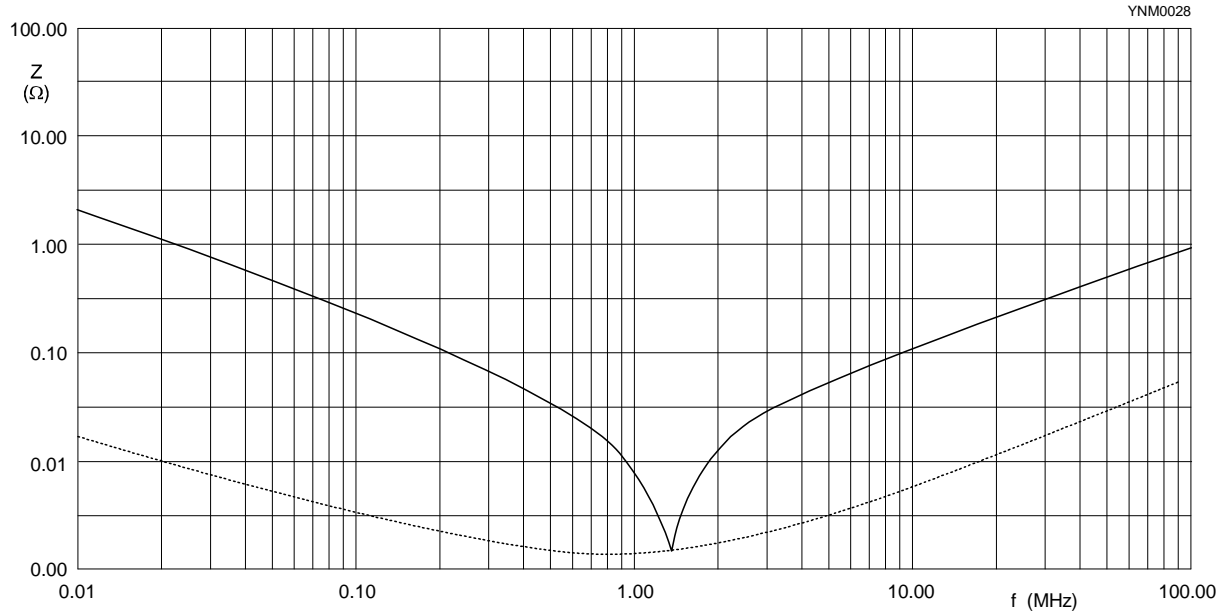

Fig. 6 Impedance ESR vs. frequency characteristics for multilayer chip capacitors

Size 1206 10 μ F / 16 V
Solid lines: Impedance / Dotted lines: ESR

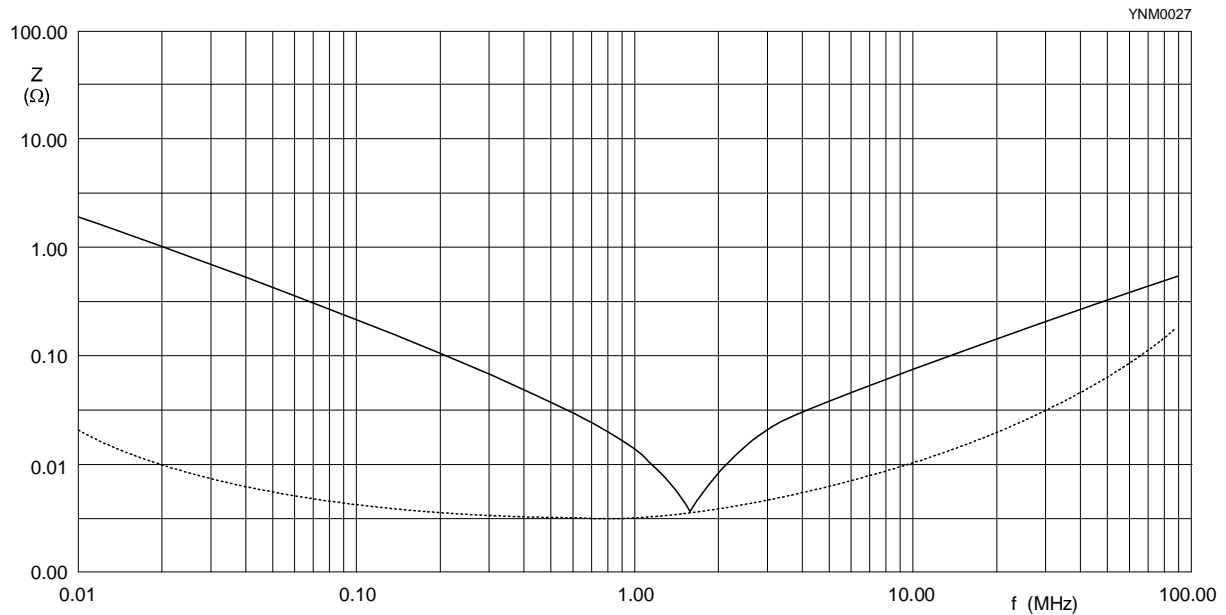

Fig. 7 Impedance ESR vs. frequency characteristics for multilayer chip capacitors

Size 1210 10 μ F / 25 V
Solid lines: Impedance / Dotted lines: ESR

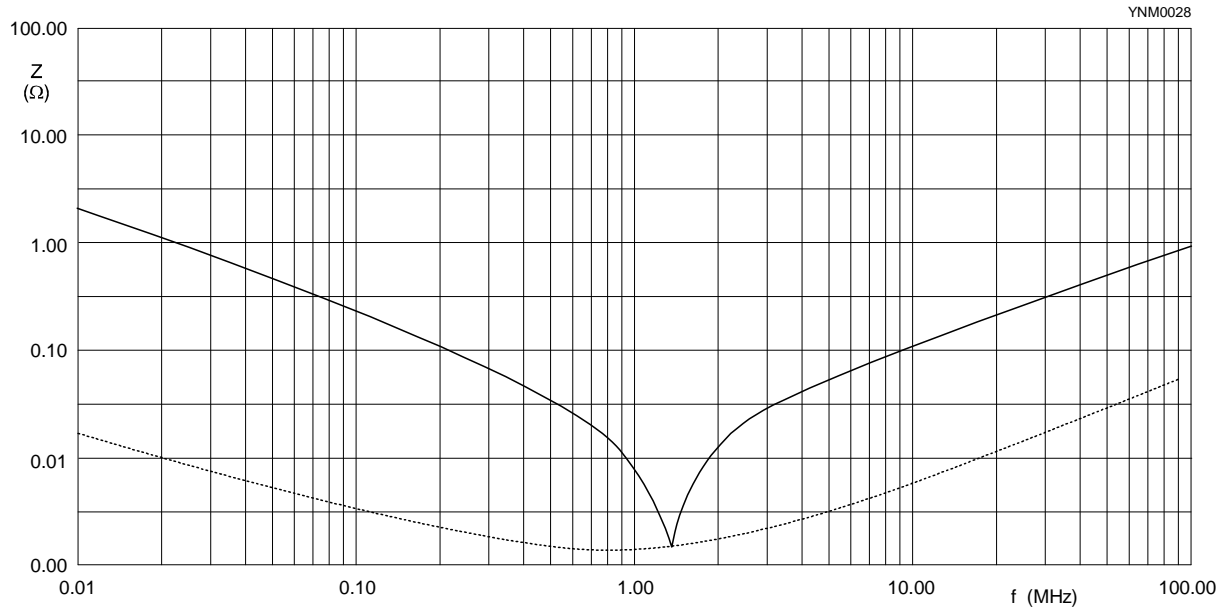

Fig. 8 Impedance ESR vs. frequency characteristics for multilayer chip capacitors

SOLDERING RECOMMENDATION

Table 12

SOLDERING METHOD	SIZE					
	0201	0402	0603	0805	1206	≥ 1210
Reflow	Reflow only	> 100 nF	> 1 μ F	> 2.2 μ F	> 2.2 μ F	Reflow only
Reflow/Wave		≤ 100 nF	≤ 1 μ F	≤ 2.2 μ F	≤ 2.2 μ F	---

TESTS AND REQUIREMENTS

Table 13 Test procedures and requirements

TEST	TEST METHOD	PROCEDURE	REQUIREMENTS
Mounting	IEC 60384-21/22	4.3 The capacitors may be mounted on printed-circuit boards or ceramic substrates	No visible damage
Visual Inspection and Dimension Check	4.4	Any applicable method using × 10 magnification	In accordance with specification
Capacitance ⁽¹⁾	4.5.1	Class 2:	Within specified tolerance
Dissipation Factor (D.F.) ⁽¹⁾	4.5.2	At 20 °C, 24 hrs after annealing Cap ≤ 1 μF, f = 1 KHz, measuring at voltage 1 Vrms at 20 °C Cap > 1μF, f = 1 KHz for C ≤ 10 μF, rated voltage > 6.3 V, measuring at voltage 1 Vrms at 20 °C f = 1 KHz, for C ≤ 10 μF, rated voltage ≤ 6.3 V, measuring at voltage 0.5 Vrms at 20 °C f = 120 Hz for C > 10 μF, measuring at voltage 0.5 Vrms at 20 °C	
Insulation Resistance	4.5.3	At U _r (DC) for 1 minute	In accordance with specification

NOTE

1. The figure indicates typical inspection. Please refer to individual specifications.

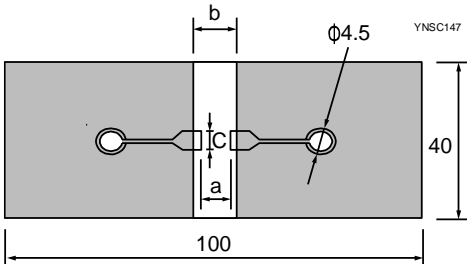
TEST	TEST METHOD	PROCEDURE	REQUIREMENTS																															
Temperature Characteristic	4.6	<p>Capacitance shall be measured by the steps shown in the following table.</p> <p>The capacitance change should be measured after 5 min at each specified temperature stage.</p> <table border="1"> <tr> <th>Step</th> <th>Temperature(°C)</th> </tr> <tr> <td>a</td> <td>25±2</td> </tr> <tr> <td>b</td> <td>Lower temperature±3°C</td> </tr> <tr> <td>c</td> <td>25±2</td> </tr> <tr> <td>d</td> <td>Upper Temperature±2°C</td> </tr> <tr> <td>e</td> <td>25±2</td> </tr> </table> <p>(1) Class I</p> <p>Temperature Coefficient shall be calculated from the formula as below</p> $\text{Temp. Coefficient} = \frac{C2 - C1}{C1 \times \Delta T} \times 10^6 \text{ [ppm/°C]}$ <p>C1: Capacitance at step c C2: Capacitance at 125°C ΔT: 100°C (=125°C -25°C)</p> <p>(2) Class II</p> <p>Capacitance Change shall be calculated from the formula as below</p> $\Delta C = \frac{C2 - C1}{C1} \times 100\%$ <p>C1: Capacitance at step c C2: Capacitance at step b or d</p>	Step	Temperature(°C)	a	25±2	b	Lower temperature±3°C	c	25±2	d	Upper Temperature±2°C	e	25±2	<p><General purpose series></p> <p>Class1: Δ C/C: ±30ppm</p> <p>Class2: X7R: Δ C/C: ±15% Y5V: Δ C/C: 22~-82%</p> <p><High Capacitance series></p> <p>Class2: X7R/X5R: Δ C/C: ±15% Y5V: Δ C/C: 22~-82%</p>																			
Step	Temperature(°C)																																	
a	25±2																																	
b	Lower temperature±3°C																																	
c	25±2																																	
d	Upper Temperature±2°C																																	
e	25±2																																	
Adhesion	4.7	<p>A force applied for 10 seconds to the line joining the terminations and in a plane parallel to the substrate</p>	<p>Force</p> <p>size ≥ 0603: 5N size = 0402: 2.5N size = 0201: 1N</p>																															
Bending Strength	IEC 60384-21/22 4.8	<p>Mounting in accordance with IEC 60384-22 paragraph 4.3</p> <p>Conditions: bending 1 mm at a rate of 1 mm/s, radius jig 5 mm</p> <p>Test Substrate:</p> 	<p>No visible damage</p> <p>ΔC/C</p> <p>Class2:</p> <p><General purpose series></p> <p>X5R: ±10%</p> <p><High Capacitance series></p> <p>X5R: ±12.5%</p> <table border="1"> <thead> <tr> <th rowspan="2">Type</th> <th colspan="3">Dimension(mm)</th> </tr> <tr> <th>a</th> <th>b</th> <th>c</th> </tr> </thead> <tbody> <tr> <td>0201</td> <td>0.3</td> <td>0.9</td> <td>0.3</td> </tr> <tr> <td>0402</td> <td>0.4</td> <td>1.5</td> <td>0.5</td> </tr> <tr> <td>0603</td> <td>1.0</td> <td>3.0</td> <td>1.2</td> </tr> <tr> <td>0805</td> <td>1.2</td> <td>4.0</td> <td>1.65</td> </tr> <tr> <td>1206</td> <td>2.2</td> <td>5.0</td> <td>1.65</td> </tr> <tr> <td>1210</td> <td>2.2</td> <td>5.0</td> <td>2.0</td> </tr> </tbody> </table> <p>Unit: mm</p>	Type	Dimension(mm)			a	b	c	0201	0.3	0.9	0.3	0402	0.4	1.5	0.5	0603	1.0	3.0	1.2	0805	1.2	4.0	1.65	1206	2.2	5.0	1.65	1210	2.2	5.0	2.0
Type	Dimension(mm)																																	
	a	b	c																															
0201	0.3	0.9	0.3																															
0402	0.4	1.5	0.5																															
0603	1.0	3.0	1.2																															
0805	1.2	4.0	1.65																															
1206	2.2	5.0	1.65																															
1210	2.2	5.0	2.0																															

TEST	TEST METHOD	PROCEDURE	REQUIREMENTS
Resistance to Soldering Heat	4.9	<p>Precondition: 150 +0/-10 °C for 1 hour, then keep for 24 ± 1 hours at room temperature</p> <p>Preheating: for size ≤ 1206: 120 °C to 150 °C for 1 minute</p> <p>Preheating: for size > 1206: 100 °C to 120 °C for 1 minute and 170 °C to 200 °C for 1 minute</p> <p>Solder bath temperature: 260 ± 5 °C</p> <p>Dipping time: 10 ± 0.5 seconds</p> <p>Recovery time: 24 ± 2 hours</p>	<p>Dissolution of the end face plating shall not exceed 25% of the length of the edge concerned</p> <hr/> <p><General purpose series> ΔC/C Class2: X5R: ±10%</p> <p><High Capacitance series> ΔC/C Class2: X5R: ±10%</p> <hr/> <p>D.F. within initial specified value R_{ins} within initial specified value</p>
Solderability	4.10	<p>Preheated the temperature of 80 °C to 140 °C and maintained for 30 seconds to 60 seconds.</p> <p>1. Temperature: 235±5°C / Dipping time: 2 ±0.5 s</p> <p>2. Temperature: 245±5°C / Dipping time: 3 ±0.5 s (lead free)</p> <p>Depth of immersion: 10mm</p>	<p>The solder should cover over 95% of the critical area of each termination</p>
Rapid Change of Temperature	IEC 60384-21/22 4.11	<p>Preconditioning: 150 +0/-10 °C for 1 hour, then keep for 24 ± 1 hours at room temperature</p> <p>5 cycles with following detail: 30 minutes at lower category temperature 30 minutes at upper category temperature</p> <p>Recovery time 24 ± 2 hours</p>	<p>No visual damage</p> <hr/> <p><General purpose series> ΔC/C Class2: X5R: ±15%</p> <p><High Capacitance series> ΔC/C Class2: X5R: ±15%</p> <hr/> <p>D.F. meet initial specified value R_{ins} meet initial specified value</p>
Voltage Proof	IEC 60384-1 4.6	<p>1. Specified stress voltage applied for 1~5 seconds</p> <p>2. U_r ≤ 100 V: series applied 2.5 U_r</p> <p>3. 100 V < U_r ≤ 200 V series applied (1.5 U_r + 100)</p> <p>4. 200 V < U_r ≤ 500 V series applied (1.3 U_r + 100)</p> <p>Charge/Discharge current is less than 50 mA.</p>	<p>No breakdown or flashover</p>

TEST	TEST METHOD	PROCEDURE	REQUIREMENTS				
Damp Heat with U_r Load	4.13	<ol style="list-style-type: none"> 1. Preconditioning, class 2 only: 150 +0/-10 °C /1 hour, then keep for 24 ±1 hour at room temp 2. Initial measure: Spec: refer to initial spec C, D, IR 3. Damp heat test: 500 ±12 hours at 40 ±2 °C; 90 to 95% R.H. 1.0 U_r applied 4. Recovery: Class 2: 24 ±2 hours 5. Final measure: C, D, IR <p>P.S. If the capacitance value is less than the minimum value permitted, then after the other measurements have been made the capacitor shall be preconditioned according to "IEC 60384 4.1" and then the requirements shall be met.</p>	<p>No visual damage after recovery</p> <p><General purpose series> $\Delta C/C$ Class2: X5R: ±15% D.F. Class2: X5R: $\leq 16V: \leq 7\%$ or 2 x initial value whichever is greater $\geq 25V: \leq 5\%$ or 2 x initial value whichever is greater R_{ins} Class2: X5R: $\geq 500 M\Omega$ or $R_{ins} \times C_r \geq 25s$ whichever is less</p> <p><High Capacitance series> $\Delta C/C$ Class2: X5R: ±20% D.F. Class2: X5R: 2 x initial value max R_{ins} Class2: $R_{ins} \times C_r \geq 5s$ whichever is less</p>				
X5R	0201	0402	0603	0805	1206	1210	Product Type
≤ 6.3V	100pF to 82nF	22nF to 820nF	220nF to 1uF	470nF to 2.2uF	1uF, 2.2uF	1uF, 2.2uF	General Purpose
	100nF to 4.7uF	1uF to 22uF	2.2uF to 47uF	4.7uF to 47uF	4.7uF to 100uF	4.7uF to 220uF	High Capacitance
10V	100pF to 82nF	22nF to 820nF	220nF to 1uF	470nF to 2.2uF	1uF, 2.2uF	1uF, 2.2uF	General Purpose
	100nF to 2.2uF	1uF to 10uF	2.2uF to 22uF	4.7uF to 47uF	4.7uF to 47uF	4.7uF to 100uF	High Capacitance
16V	100pF to 82nF	22nF to 820nF	220nF to 1uF	470nF to 2.2uF	1uF, 2.2uF	1uF, 2.2uF	General Purpose
	100nF to 470nF	1uF to 4.7uF	2.2uF to 10uF	4.7uF to 22uF	4.7uF to 22uF	4.7uF to 100uF	High Capacitance
25V	100pF to 82nF	22nF to 220nF	220nF to 1uF	470nF to 2.2uF	1uF, 2.2uF	1uF, 2.2uF	General Purpose
	100nF to 220nF	270nF to 2.2uF	2.2uF to 10uF	4.7uF to 22uF	4.7uF to 22uF	4.7uF to 22uF	High Capacitance
50V	100pF to 82nF	22nF to 100nF	220nF to 820nF	470nF to 2.2uF	1uF, 2.2uF	1uF, 2.2uF	General Purpose
	100nF	220nF to 1uF	1uF, 2.2uF	4.7uF	4.7uF, 10uF	4.7uF, 10uF	High Capacitance

TEST	TEST METHOD	PROCEDURE	REQUIREMENTS
Endurance	IEC 60384- 21/22 4.14	<ol style="list-style-type: none"> Preconditioning, class 2 only: 150 +0/-10 °C /1 hour, then keep for 24 ±1 hour at room temp Initial measure: Spec: refer to initial spec C, D, IR Endurance test: Temperature: X5R: 85 °C Specified stress voltage applied (2.0/1.5/1.0 × Ur) for 1,000 hours Recovery time: 24 ±2 hours Final measure: C, D, IR <p>P.S. If the capacitance value is less than the minimum value permitted, then after the other measurements have been made the capacitor shall be preconditioned according to "IEC 60384 4.1" and then the requirements shall be met.</p>	<p>No visual damage</p> <hr/> <p><General purpose series - 2.0 × Ur> ΔC/C Class2: X5R: ±15% D.F. Class2: X5R: ≤ 16V: ≤ 7% or 2 × initial value whichever is greater ≥ 25V: ≤ 5% or 2 × initial value whichever is greater R_{ins} Class2: X5R: ≥ 1,000 MΩ or R_{ins} × C_r ≥ 50s whichever is less</p> <hr/> <p><High Capacitance series - 1.0/1.5 × Ur> ΔC/C Class 2: X5R: ±20% D.F. Class 2: X5R: 2 × initial value max R_{ins} Class 2: R_{ins} × C_r ≥ 10s whichever is less</p>

X5R	0201	0402	0603	0805	1206	1210	Test voltage
≤ 6.3V	100pF to 82nF	22nF to 820nF	220nF to 1uF	470nF to 2.2uF	1uF, 2.2uF	1uF, 2.2uF	200% × Rated voltage
	100nF to 330nF	1uF to 2.2uF	2.2uF to 10uF	4.7uF to 22uF	4.7uF to 100uF	4.7uF to 220uF	150% × Rated voltage
	470nF to 4.7uF	4.7uF to 22uF	22uF, 47uF	47uF			100% × Rated voltage
10V	100pF to 82nF	22nF to 820nF	220nF to 1uF	470nF to 2.2uF	1uF, 2.2uF	1uF, 2.2uF	200% × Rated voltage
	100nF to 820nF	1uF, 2.2uF	2.2uF, 4.7uF	4.7uF, 10uF	4.7uF to 47uF	4.7uF to 100uF	150% × Rated voltage
	1uF*, 2.2uF	4.7uF, 10uF	10uF, 22uF	22uF, 47uF			100% × Rated voltage
16V	100pF to 82nF	22nF to 820nF	220nF to 1uF	470nF to 2.2uF	1uF, 2.2uF	1uF, 2.2uF	200% × Rated voltage
	100nF to 470nF	1uF, 2.2uF	2.2uF, 4.7uF	4.7uF, 10uF	4.7uF to 22uF	4.7uF to 100uF	150% × Rated voltage
		4.7uF	10uF	22uF			100% × Rated voltage
25V	100pF to 82nF	22nF to 220nF	220nF to 1uF	470nF to 2.2uF	1uF, 2.2uF	1uF, 2.2uF	200% × Rated voltage
	220nF	270nF to 2.2uF	2.2uF	4.7uF	4.7uF to 22uF	4.7uF to 22uF	150% × Rated voltage
	100nF		4.7uF, 10uF	10uF, 22uF			100% × Rated voltage
50V	100pF to 82nF	22nF to 100nF	220nF to 820nF	470nF to 2.2uF	1uF, 2.2uF	1uF, 2.2uF	200% × Rated voltage
		220nF, 1uF	1uF, 2.2uF	4.7uF	4.7uF	4.7uF, 10uF	150% × Rated voltage
	100nF	470nF			10uF		100% × Rated voltage

* thickness BC for 150% × Rated Voltage, BB for 100% × Rated Voltage.



REVISION HISTORY

REVISION	DATE	CHANGE NOTIFICATION	DESCRIPTION
Version 30	Dec. 06, 2022	-	- 0201/560nF to 1uF/ 6.3V I.R. updated
Version 29	Sep. 23, 2022	-	- I206/4.7uF/6.3V to 10V I.R. updated
Version 28	Sep. 19, 2022	-	- D.F. and I.R. spec updated.
Version 27	Sep. 17, 2021	-	- Modify 0402 L4 spec
Version 26	Mar. 26, 2020	-	- Capacitance range updated for 0201/0805/I206, 0201 D.F spec update, I210 dimension update
Version 25	Jun. 2, 2017	-	- I.R spec updated
Version 24	Mar. 6, 2017	-	- 0805 L4 spec updated
Version 23	Nov. 15, 2016	-	- Dimension updated
Version 22	Oct. 3, 2016	-	- Dimension and Soldering recommendation updated
Version 21	Jan. 28, 2016	-	- Tests and requirements updated
Version 20	Dec. 04, 2015	-	- Size updated
Version 19	Apr. 09, 2015	-	- Voltage updated
Version 18	Jul. 07, 2014	-	- Voltage updated
Version 17	Mar. 31, 2014	-	- Test condition updated
Version 16	Nov. 29, 2012	-	- Test condition updated
Version 15	Sep. 03, 2012	-	- Test condition updated
Version 14	May 16, 2012	-	- Product range updated
Version 13	May 02, 2012	-	- Product range updated
Version 12	Feb 10, 2012	-	- Product range updated
Version 11	Oct 21, 2011	-	- Product range updated
Version 10	Jun 21, 2011	-	- Product range updated
Version 9	Mar 23, 2011	-	- Product range updated
Version 8	Jan 25, 2011	-	- Rated voltage of 0201 extend to 50V
Version 7	Jan 05, 2011	-	- Product range updated
Version 6	Jul 27, 2010	-	- Dimension on 0603 and I206 case size updated
Version 5	Apr 21, 2010	-	- The statement of "Halogen free" on the cover added - Dimension updated
Version 4	Jan 13, 2010	-	- Thickness updated
Version 3	Aug 17, 2009	-	- Dimension updated
Version 2	Jun 09, 2009	-	- Ordering code updated

REVISION HISTORY

REVISION	DATE	CHANGE NOTIFICATION	DESCRIPTION
Version 1	May 15, 2009	-	- Product range updated
Version 0	Apr 15, 2009	-	<ul style="list-style-type: none"> - New datasheet for general purpose and high capacitance X5R series with RoHS compliant - Replace the "6.3V to 50V" part of pdf files: UP-X5R_X7R_HighCaps_6.3-to-25V_1 I, UY-X5R_X7R_HighCaps_6.3-to-25V_1 I - Combine 0201 from pdf files: UP-NP0X5RX7RY5V_0201_6.3-to-50V_2 and UY-NPOX5RX7RY5V_0201_6.3-to-50V_2 - Define global part number - Description of "Halogen free compliant" added - Test method and procedure updated

LEGAL DISCLAIMER

YAGEO, its distributors and agents (collectively, "YAGEO"), hereby disclaims any and all liabilities for any errors, inaccuracies or incompleteness contained in any product related information, including but not limited to product specifications, datasheets, pictures and/or graphics. YAGEO may make changes, modifications and/or improvements to product related information at any time and without notice.



YAGEO makes no representation, warranty, and/or guarantee about the fitness of its products for any particular purpose or the continuing production of any of its products. To the maximum extent permitted by law, YAGEO disclaims (i) any and all liability arising out of the application or use of any YAGEO product, (ii) any and all liability, including without limitation special, consequential or incidental damages, and (iii) any and all implied warranties, including warranties of fitness for a particular purpose, non-infringement and merchantability.

YAGEO products are designed for general purpose applications under normal operation and usage conditions. Please contact YAGEO for the applications listed below which require especially high reliability for the prevention of defects which might directly cause damage to the third party's life, body or property: Aerospace equipment (artificial satellite, rocket, etc.), Atomic energy-related equipment, Aviation equipment, Disaster prevention equipment, crime prevention equipment, Electric heating apparatus, burning equipment, Highly public information network equipment, data-processing equipment, Medical devices, Military equipment, Power generation control equipment, Safety equipment, Traffic signal equipment, Transportation equipment and Undersea equipment, or for any other application or use in which the failure of YAGEO products could result in personal injury or death, or serious property damage. Particularly **YAGEO Corporation and its affiliates do not recommend the use of commercial or automotive grade products for high reliability applications or manned space flight.**







Information provided here is intended to indicate product specifications only. YAGEO reserves all the rights for revising this content without further notification, as long as products are unchanged. Any product change will be announced by PCN.

Looking for pricing, stock, or lifecycle information?

Click below to explore more details on WIN SOURCE:

-  [View CC0603MKX5R5BB476 on WIN SOURCE](#)
-  [Yageo Information](#)

Optimize Your Supply Chain with WIN SOURCE Solutions

-  Global Sourcing Solution
-  Obsolete Management
-  Cost Control Management
-  Shortage Management
-  Alternative Solution
-  Excess Inventory Management