

DATA SHEET

SURFACE-MOUNT CERAMIC MULTILAYER CAPACITORS

General purpose

Class 1, NP0

16 V TO 50 V

0.22 pF to 100 nF

RoHS compliant & Halogen Free



SCOPE

This specification describes NPO series chip capacitors with lead-free terminations.

APPLICATIONS

- Consumer electronics for example
 - Tuners
 - Television receivers
 - All types of cameras
- Telecommunications
- Data processing

FEATURES

- Supplied in tape on reel
- Nickel-barrier end termination
- RoHS compliant
- Halogen Free compliant

ORDERING INFORMATION - GLOBAL PART NUMBER, PHYCOMP CTC & I2NC

All part numbers are identified by the series, size, tolerance, TC material, packing style, voltage, process code, termination and capacitance value.

YAGEO BRAND ordering code

GLOBAL PART NUMBER (PREFERRED)

CC XXXX X X **NPO** X **BN** XXX
 (1) (2) (3) (4) (5)

(1) SIZE – INCH BASED (METRIC)

- 0201 (0603)
- 0402 (1005)
- 0603 (1608)
- 0805 (2012)
- 1206 (3216)
- 1210 (3225)
- 1812 (4532)

(2) TOLERANCE

- B = ±0.1 pF
- C = ±0.25 pF
- D = ±0.5 pF
- F = ±1%
- G = ±2%
- J = ±5%
- K = ±10%

(3) PACKING STYLE

- R = Paper/PE taping reel; Reel 7 inch
- K = Blister taping reel; Reel 7 inch
- P = Paper/PE taping reel; Reel 13 inch
- F = Blister taping reel; Reel 13 inch
- C = Bulk case

(4) RATED VOLTAGE

- 7 = 16 V
- 8 = 25 V
- 9 = 50 V

(5) CAPACITANCE VALUE

2 significant digits+number of zeros
 The 3rd digit signifies the multiplying factor, and letter R is decimal point
 Example: 121 = 12 × 10¹ = 120 pF

CONSTRUCTION

The capacitor consists of a rectangular block of ceramic dielectric in which a number of interleaved metal electrodes are contained. This structure gives rise to a high capacitance per unit volume.

The inner electrodes are connected to the two end terminations and finally covered with a layer of plated tin (NiSn). The terminations are lead-free. A cross section of the structure is shown in Fig.1.

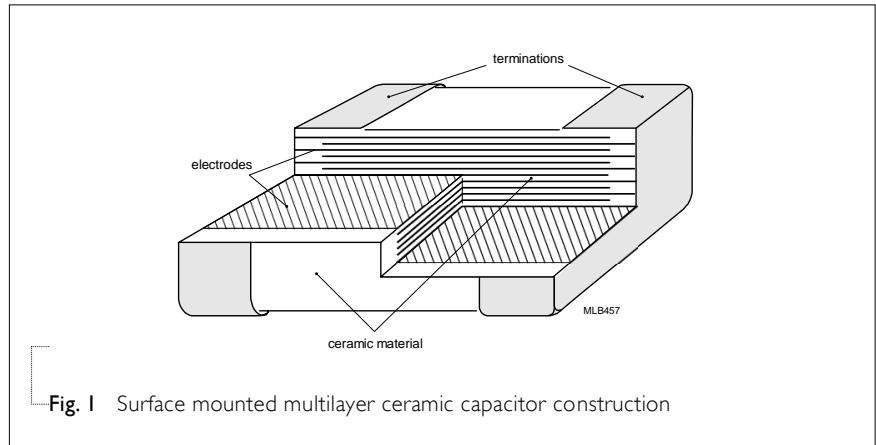

Fig. 1 Surface mounted multilayer ceramic capacitor construction

DIMENSION

Table I For outlines see fig. 2

TYPE	L ₁ (mm)	W (mm)	T (MM)	L ₂ / L ₃ (mm)		L ₄ (mm)
				min.	max.	min.
0201	0.6 ±0.03	0.3 ±0.03	Refer to table 2 to 5	0.10	0.20	0.20
0402	1.0 ±0.05	0.5 ±0.05		0.15	0.35	0.30
0603	1.6 ±0.10	0.8 ±0.10		0.20	0.60	0.40
0805	2.0 ±0.10 ⁽¹⁾	1.25 ±0.10 ⁽¹⁾		0.25	0.75	0.70
	2.0 ±0.20 ⁽²⁾	1.25 ±0.20 ⁽²⁾				
1206	3.2 ±0.15 ⁽¹⁾	1.6 ±0.15 ⁽¹⁾		0.25	0.75	1.40
	3.2 ±0.30 ⁽²⁾	1.6 ±0.20 ⁽²⁾				
1210	3.2 ±0.20	2.5 ±0.20		0.25	0.75	1.40
1812	4.5 ±0.40	3.2 ±0.30	0.25	0.75	2.20	

NOTE

1. Dimension for size 0805 and 1206, C ≤ 1 nF
2. Dimension for size 0805 and 1206, C > 1 nF

OUTLINES

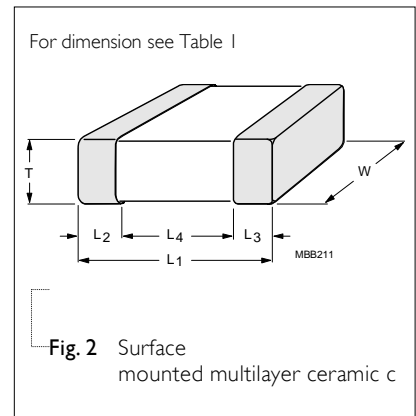

Fig. 2 Surface mounted multilayer ceramic c

CAPACITANCE RANGE & THICKNESS FOR NPO

Table 2 Sizes from 0201 to 0603

CAP.	0201		0402		0603			
	25 V	50 V	16 V	25 V	50 V	16 V	25 V	50 V
0.22 pF	0.3±0.03	0.3±0.03						
0.47 pF	0.3±0.03	0.3±0.03	0.5±0.05	0.5±0.05	0.5±0.05	0.8±0.1	0.8±0.1	0.8±0.1
0.82 pF	0.3±0.03	0.3±0.03	0.5±0.05	0.5±0.05	0.5±0.05	0.8±0.1	0.8±0.1	0.8±0.1
1.0 pF	0.3±0.03	0.3±0.03	0.5±0.05	0.5±0.05	0.5±0.05	0.8±0.1	0.8±0.1	0.8±0.1
1.2 pF	0.3±0.03	0.3±0.03	0.5±0.05	0.5±0.05	0.5±0.05	0.8±0.1	0.8±0.1	0.8±0.1
1.5 pF	0.3±0.03	0.3±0.03	0.5±0.05	0.5±0.05	0.5±0.05	0.8±0.1	0.8±0.1	0.8±0.1
1.8 pF	0.3±0.03	0.3±0.03	0.5±0.05	0.5±0.05	0.5±0.05	0.8±0.1	0.8±0.1	0.8±0.1
2.2 pF	0.3±0.03	0.3±0.03	0.5±0.05	0.5±0.05	0.5±0.05	0.8±0.1	0.8±0.1	0.8±0.1
2.7 pF	0.3±0.03	0.3±0.03	0.5±0.05	0.5±0.05	0.5±0.05	0.8±0.1	0.8±0.1	0.8±0.1
3.3 pF	0.3±0.03	0.3±0.03	0.5±0.05	0.5±0.05	0.5±0.05	0.8±0.1	0.8±0.1	0.8±0.1
3.9 pF	0.3±0.03	0.3±0.03	0.5±0.05	0.5±0.05	0.5±0.05	0.8±0.1	0.8±0.1	0.8±0.1
4.7 pF	0.3±0.03	0.3±0.03	0.5±0.05	0.5±0.05	0.5±0.05	0.8±0.1	0.8±0.1	0.8±0.1
5.6 pF	0.3±0.03	0.3±0.03	0.5±0.05	0.5±0.05	0.5±0.05	0.8±0.1	0.8±0.1	0.8±0.1
6.8 pF	0.3±0.03	0.3±0.03	0.5±0.05	0.5±0.05	0.5±0.05	0.8±0.1	0.8±0.1	0.8±0.1
8.2 pF	0.3±0.03	0.3±0.03	0.5±0.05	0.5±0.05	0.5±0.05	0.8±0.1	0.8±0.1	0.8±0.1
10 pF	0.3±0.03	0.3±0.03	0.5±0.05	0.5±0.05	0.5±0.05	0.8±0.1	0.8±0.1	0.8±0.1
12 pF	0.3±0.03	0.3±0.03	0.5±0.05	0.5±0.05	0.5±0.05	0.8±0.1	0.8±0.1	0.8±0.1
15 pF	0.3±0.03	0.3±0.03	0.5±0.05	0.5±0.05	0.5±0.05	0.8±0.1	0.8±0.1	0.8±0.1
18 pF	0.3±0.03	0.3±0.03	0.5±0.05	0.5±0.05	0.5±0.05	0.8±0.1	0.8±0.1	0.8±0.1
22 pF	0.3±0.03	0.3±0.03	0.5±0.05	0.5±0.05	0.5±0.05	0.8±0.1	0.8±0.1	0.8±0.1
27 pF	0.3±0.03	0.3±0.03	0.5±0.05	0.5±0.05	0.5±0.05	0.8±0.1	0.8±0.1	0.8±0.1
33 pF	0.3±0.03	0.3±0.03	0.5±0.05	0.5±0.05	0.5±0.05	0.8±0.1	0.8±0.1	0.8±0.1
39 pF	0.3±0.03	0.3±0.03	0.5±0.05	0.5±0.05	0.5±0.05	0.8±0.1	0.8±0.1	0.8±0.1
47 pF	0.3±0.03	0.3±0.03	0.5±0.05	0.5±0.05	0.5±0.05	0.8±0.1	0.8±0.1	0.8±0.1
56 pF	0.3±0.03	0.3±0.03	0.5±0.05	0.5±0.05	0.5±0.05	0.8±0.1	0.8±0.1	0.8±0.1
68 pF	0.3±0.03	0.3±0.03	0.5±0.05	0.5±0.05	0.5±0.05	0.8±0.1	0.8±0.1	0.8±0.1
82 pF	0.3±0.03	0.3±0.03	0.5±0.05	0.5±0.05	0.5±0.05	0.8±0.1	0.8±0.1	0.8±0.1
100 pF	0.3±0.03	0.3±0.03	0.5±0.05	0.5±0.05	0.5±0.05	0.8±0.1	0.8±0.1	0.8±0.1

NOTE

1. Values in shaded cells indicate thickness class in mm
2. Capacitance value of non E-12 series is on request

CAPACITANCE RANGE & THICKNESS FOR NPO

Table 3 Sizes from 0201 to 0603 (continued)

CAP.	0201		0402			0603		
	25 V	50 V	16 V	25 V	50 V	16 V	25 V	50 V
120 pF			0.5±0.05	0.5±0.05	0.5±0.05	0.8±0.1	0.8±0.1	0.8±0.1
150 pF			0.5±0.05	0.5±0.05	0.5±0.05	0.8±0.1	0.8±0.1	0.8±0.1
180 pF			0.5±0.05	0.5±0.05	0.5±0.05	0.8±0.1	0.8±0.1	0.8±0.1
220 pF			0.5±0.05	0.5±0.05	0.5±0.05	0.8±0.1	0.8±0.1	0.8±0.1
270 pF			0.5±0.05	0.5±0.05	0.5±0.05	0.8±0.1	0.8±0.1	0.8±0.1
330 pF			0.5±0.05	0.5±0.05	0.5±0.05	0.8±0.1	0.8±0.1	0.8±0.1
390 pF			0.5±0.05	0.5±0.05	0.5±0.05	0.8±0.1	0.8±0.1	0.8±0.1
470 pF			0.5±0.05	0.5±0.05	0.5±0.05	0.8±0.1	0.8±0.1	0.8±0.1
560 pF			0.5±0.05	0.5±0.05	0.5±0.05	0.8±0.1	0.8±0.1	0.8±0.1
680 pF			0.5±0.05	0.5±0.05	0.5±0.05	0.8±0.1	0.8±0.1	0.8±0.1
820 pF						0.8±0.1	0.8±0.1	0.8±0.1
1.0 nF			0.5±0.05	0.5±0.05	0.5±0.05	0.8±0.1	0.8±0.1	0.8±0.1
1.2 nF						0.8±0.1	0.8±0.1	0.8±0.1
1.5 nF						0.8±0.1	0.8±0.1	0.8±0.1
1.8 nF						0.8±0.1	0.8±0.1	0.8±0.1
2.2 nF						0.8±0.1	0.8±0.1	0.8±0.1
2.7 nF						0.8±0.1	0.8±0.1	0.8±0.1
3.3 nF						0.8±0.1	0.8±0.1	0.8±0.1
3.9 nF						0.8±0.1	0.8±0.1	0.8±0.1
4.7 nF								
5.6 nF								
6.8 nF								
8.2 nF								
10 nF						0.8±0.1	0.8±0.1	0.8±0.1
12 nF								
15 nF								
18 nF								
22 nF								
33 nF								

NOTE

1. Values in shaded cells indicate thickness class in mm
2. Capacitance value of non E-12 series is on request

CAPACITANCE RANGE & THICKNESS FOR NPO

Table 4 Sizes from 0805 to 1812

CAP.	0805			1206			1210		1812
	16 V	25 V	50 V	16 V	25 V	50 V	25 V	50 V	50 V
0.22 pF									
0.47 pF	0.6±0.1	0.6±0.1	0.6±0.1	0.6±0.1	0.6±0.1	0.6±0.1			
0.82 pF	0.6±0.1	0.6±0.1	0.6±0.1	0.6±0.1	0.6±0.1	0.6±0.1			
1.0 pF	0.6±0.1	0.6±0.1	0.6±0.1	0.6±0.1	0.6±0.1	0.6±0.1			
1.2 pF	0.6±0.1	0.6±0.1	0.6±0.1	0.6±0.1	0.6±0.1	0.6±0.1			
1.5 pF	0.6±0.1	0.6±0.1	0.6±0.1	0.6±0.1	0.6±0.1	0.6±0.1			
1.8 pF	0.6±0.1	0.6±0.1	0.6±0.1	0.6±0.1	0.6±0.1	0.6±0.1			
2.2 pF	0.6±0.1	0.6±0.1	0.6±0.1	0.6±0.1	0.6±0.1	0.6±0.1			
2.7 pF	0.6±0.1	0.6±0.1	0.6±0.1	0.6±0.1	0.6±0.1	0.6±0.1			
3.3 pF	0.6±0.1	0.6±0.1	0.6±0.1	0.6±0.1	0.6±0.1	0.6±0.1			
3.9 pF	0.6±0.1	0.6±0.1	0.6±0.1	0.6±0.1	0.6±0.1	0.6±0.1			
4.7 pF	0.6±0.1	0.6±0.1	0.6±0.1	0.6±0.1	0.6±0.1	0.6±0.1			
5.6 pF	0.6±0.1	0.6±0.1	0.6±0.1	0.6±0.1	0.6±0.1	0.6±0.1			
6.8 pF	0.6±0.1	0.6±0.1	0.6±0.1	0.6±0.1	0.6±0.1	0.6±0.1			
8.2 pF	0.6±0.1	0.6±0.1	0.6±0.1	0.6±0.1	0.6±0.1	0.6±0.1			
10 pF	0.6±0.1	0.6±0.1	0.6±0.1	0.6±0.1	0.6±0.1	0.6±0.1			
12 pF	0.6±0.1	0.6±0.1	0.6±0.1	0.6±0.1	0.6±0.1	0.6±0.1			
15 pF	0.6±0.1	0.6±0.1	0.6±0.1	0.6±0.1	0.6±0.1	0.6±0.1			
18 pF	0.6±0.1	0.6±0.1	0.6±0.1	0.6±0.1	0.6±0.1	0.6±0.1			
22 pF	0.6±0.1	0.6±0.1	0.6±0.1	0.6±0.1	0.6±0.1	0.6±0.1			
27 pF	0.6±0.1	0.6±0.1	0.6±0.1	0.6±0.1	0.6±0.1	0.6±0.1			
33 pF	0.6±0.1	0.6±0.1	0.6±0.1	0.6±0.1	0.6±0.1	0.6±0.1			
39 pF	0.6±0.1	0.6±0.1	0.6±0.1	0.6±0.1	0.6±0.1	0.6±0.1			
47 pF	0.6±0.1	0.6±0.1	0.6±0.1	0.6±0.1	0.6±0.1	0.6±0.1	1.25±0.2	1.25±0.2	
56 pF	0.6±0.1	0.6±0.1	0.6±0.1	0.6±0.1	0.6±0.1	0.6±0.1	1.25±0.2	1.25±0.2	1.25±0.2
68 pF	0.6±0.1	0.6±0.1	0.6±0.1	0.6±0.1	0.6±0.1	0.6±0.1	1.25±0.2	1.25±0.2	1.25±0.2
82 pF	0.6±0.1	0.6±0.1	0.6±0.1	0.6±0.1	0.6±0.1	0.6±0.1	1.25±0.2	1.25±0.2	1.25±0.2
100 pF	0.6±0.1	0.6±0.1	0.6±0.1	0.6±0.1	0.6±0.1	0.6±0.1	1.25±0.2	1.25±0.2	1.25±0.2

NOTE

1. Values in shaded cells indicate thickness class in mm
2. Capacitance value of non E-12 series is on request

CAPACITANCE RANGE & THICKNESS FOR NPO

Table 5 Sizes from 0805 to 1812 (continued)

CAP.	0805			1206			1210		1812
	16 V	25 V	50 V	16 V	25 V	50 V	25 V	50 V	50 V
120 pF	0.6±0.1	0.6±0.1	0.6±0.1	0.6±0.1	0.6±0.1	0.6±0.1	1.25±0.2	1.25±0.2	1.25±0.2
150 pF	0.6±0.1	0.6±0.1	0.6±0.1	0.6±0.1	0.6±0.1	0.6±0.1	1.25±0.2	1.25±0.2	1.25±0.2
180 pF	0.6±0.1	0.6±0.1	0.6±0.1	0.6±0.1	0.6±0.1	0.6±0.1	1.25±0.2	1.25±0.2	1.25±0.2
220 pF	0.6±0.1	0.6±0.1	0.6±0.1	0.6±0.1	0.6±0.1	0.6±0.1	1.25±0.2	1.25±0.2	1.25±0.2
270 pF	0.6±0.1	0.6±0.1	0.6±0.1	0.6±0.1	0.6±0.1	0.6±0.1	1.25±0.2	1.25±0.2	1.25±0.2
330 pF	0.6±0.1	0.6±0.1	0.6±0.1	0.6±0.1	0.6±0.1	0.6±0.1	1.25±0.2	1.25±0.2	1.25±0.2
390 pF	0.6±0.1	0.6±0.1	0.6±0.1	0.6±0.1	0.6±0.1	0.6±0.1	1.25±0.2	1.25±0.2	1.25±0.2
470 pF	0.6±0.1	0.6±0.1	0.6±0.1	0.6±0.1	0.6±0.1	0.6±0.1	1.25±0.2	1.25±0.2	1.25±0.2
560 pF	0.6±0.1	0.6±0.1	0.6±0.1	0.6±0.1	0.6±0.1	0.6±0.1	1.25±0.2	1.25±0.2	1.25±0.2
680 pF	0.6±0.1	0.6±0.1	0.6±0.1	0.6±0.1	0.6±0.1	0.6±0.1	1.25±0.2	1.25±0.2	1.25±0.2
820 pF	0.6±0.1	0.6±0.1	0.6±0.1	0.6±0.1	0.6±0.1	0.6±0.1	1.25±0.2	1.25±0.2	1.25±0.2
1.0 nF	0.6±0.1	0.6±0.1	0.6±0.1	0.6±0.1	0.6±0.1	0.6±0.1	1.25±0.2	1.25±0.2	1.25±0.2
1.2 nF	0.85±0.1	0.85±0.1	0.85±0.1	0.6±0.1	0.6±0.1	0.6±0.1	1.25±0.2	1.25±0.2	1.25±0.2
1.5 nF	0.85±0.1	0.85±0.1	0.85±0.1	0.6±0.1	0.6±0.1	0.6±0.1	1.25±0.2	1.25±0.2	1.25±0.2
1.8 nF	0.85±0.1	0.85±0.1	0.85±0.1	0.6±0.1	0.6±0.1	0.6±0.1	1.25±0.2	1.25±0.2	1.25±0.2
2.2 nF	1.25±0.2	1.25±0.2	1.25±0.2	0.6±0.1	0.6±0.1	0.6±0.1	1.25±0.2	1.25±0.2	1.25±0.2
2.7 nF	1.25±0.2	1.25±0.2	1.25±0.2	0.6±0.1	0.6±0.1	0.6±0.1	1.25±0.2	1.25±0.2	1.25±0.2
3.3 nF	1.25±0.2	1.25±0.2	1.25±0.2	0.85±0.1	0.85±0.1	0.85±0.1	1.25±0.2	1.25±0.2	1.25±0.2
3.9 nF	1.25±0.2	1.25±0.2	1.25±0.2	0.85±0.1	0.85±0.1	0.85±0.1	1.25±0.2	1.25±0.2	1.25±0.2
4.7 nF	1.25±0.2	1.25±0.2	1.25±0.2	0.85±0.1	0.85±0.1	0.85±0.1	1.25±0.2	1.25±0.2	1.25±0.2
5.6 nF	1.25±0.2	1.25±0.2	1.25±0.2	0.85±0.1	0.85±0.1	0.85±0.1	1.25±0.2	1.25±0.2	1.25±0.2
6.8 nF	1.25±0.2	1.25±0.2	1.25±0.2	0.85±0.1	0.85±0.1	0.85±0.1	1.25±0.2	1.25±0.2	1.25±0.2
8.2 nF	1.25±0.2	1.25±0.2	1.25±0.2	1.25±0.2	1.25±0.2	1.25±0.2	1.25±0.2	1.25±0.2	1.25±0.2
10 nF	1.25±0.2	1.25±0.2	1.25±0.2	1.25±0.2	1.25±0.2	1.25±0.2	1.25±0.2	1.25±0.2	1.25±0.2
12 nF				0.85±0.1	0.85±0.1	0.85±0.1			1.25±0.2
15 nF				0.85±0.1	0.85±0.1	0.85±0.1			1.25±0.2
18 nF				0.85±0.1	0.85±0.1	0.85±0.1			1.25±0.2
22 nF				0.85±0.1	0.85±0.1	0.85±0.1	2.0±0.2	2.0±0.2	1.25±0.2
33 nF				0.85±0.1	0.85±0.1	0.85±0.1			
47 nF				1.25±0.2	1.25±0.2	1.25±0.2	1.60±0.2	1.60±0.2	
56 nF									
68 nF				1.60±0.2	1.60±0.2	1.60±0.2			
82 nF									
100 nF				1.60±0.2	1.60±0.2	1.60±0.2			

NOTE

1. Values in shaded cells indicate thickness class in mm
2. Capacitance value of non E-I2 series is on request

THICKNESS CLASSES AND PACKING QUANTITY

Table 6

SIZE CODE	THICKNESS CLASSIFICATION	TAPE WIDTH QUANTITY PER REEL	Ø180 MM / 7 INCH		Ø330 MM / 13 INCH		QUANTITY PER BULK CASE
			Paper	Blister	Paper	Blister	
0201	0.3 ±0.03 mm	8 mm	15,000	---	50,000	---	---
0402	0.5 ±0.05 mm	8 mm	10,000	---	50,000	---	50,000
0603	0.8 ±0.1 mm	8 mm	4,000	---	15,000	---	15,000
0805	0.6 ±0.1 mm	8 mm	4,000	---	20,000	---	10,000
	0.85 ±0.1 mm	8 mm	4,000	---	15,000	---	8,000
	1.25 ±0.2 mm	8 mm	---	3,000	---	10,000	5,000
1206	0.6 ±0.1 mm	8 mm	4,000	---	20,000	---	---
	0.85 ±0.1 mm	8 mm	4,000	---	15,000	---	---
	1.00 / 1.15 ±0.1 mm	8 mm	---	3,000	---	10,000	---
	1.25 ±0.2 mm	8 mm	---	3,000	---	10,000	---
	1.6 ±0.15 mm	8 mm	---	2,500	---	10,000	---
	1.6 ±0.2 mm	8 mm	---	2,000	---	10,000	---
1210	0.6 / 0.7 ±0.1 mm	8 mm	---	4,000	---	15,000	---
	0.85 ±0.1 mm	8 mm	---	4,000	---	10,000	---
	1.0 ±0.1 mm	8 mm	---	3,000	---	10,000	---
	1.15 ±0.1 mm	8 mm	---	3,000	---	10,000	---
	1.15 ±0.15 mm	8 mm	---	3,000	---	10,000	---
	1.25 ±0.2 mm	8 mm	---	3,000	---	---	---
	1.5 ±0.1 mm	8 mm	---	2,000	---	---	---
	1.6 / 1.9 ±0.2 mm	8 mm	---	2,000	---	---	---
	2.0 ±0.2 mm	8 mm	---	2,000 1,000	---	---	---
1808	1.15 ±0.15 mm	12 mm	---	3,000	---	---	---
	1.25 ±0.2 mm	12 mm	---	3,000	---	---	---
	1.35 ±0.15 mm	12 mm	---	2,000	---	---	---
	1.5 ±0.1 mm	12 mm	---	2,000	---	---	---
	1.6 ±0.2 mm	12 mm	---	2,000	---	---	---
	2.0 ±0.2 mm	12 mm	---	2,000	---	---	---
1812	0.6 / 0.85 ±0.1 mm	12 mm	---	2,000	---	---	---
	1.15 ±0.1 mm	12 mm	---	1,000	---	---	---
	1.15 ±0.15 mm	12 mm	---	1,000	---	---	---
	1.35 ±0.15 mm	12 mm	---	1,000	---	---	---
	1.5 ±0.1 mm	12 mm	---	1,000	---	---	---
	1.6 ±0.2 mm	12 mm	---	1,000	---	---	---
	2.0 ±0.2 mm	12 mm	---	1,000	---	---	---
2.5 ±0.2 mm	12 mm	---	500	---	---	---	

ELECTRICAL CHARACTERISTICS

NP0 DIELECTRIC CAPACITORS; NISN TERMINATIONS

Unless otherwise stated all electrical values apply at an ambient temperature of 20 ± 1 °C, an atmospheric pressure of 86 to 106 kPa, and a relative humidity of 63 to 67%.

Table 7

DESCRIPTION	VALUE
Capacitance range	0.22 pF to 100 nF
Capacitance tolerance	
C < 10 pF	±0.1 pF, ±0.25 pF, ±0.5 pF
C ≥ 10 pF	±1%, ±2%, ±5%, ±10%
Dissipation factor (D.F.)	
C < 30 pF	≤ 1 / (400 + 20C)
C ≥ 30 pF	≤ 0.1 %
Insulation resistance after 1 minute at U_r (DC)	$R_{ins} \geq 10 \text{ G}\Omega$ or $R_{ins} \times C_r \geq 500$ seconds whichever is less
Maximum capacitance change as a function of temperature (temperature characteristic/coefficient):	±30 ppm/°C
Operating temperature range:	-55 °C to +125 °C

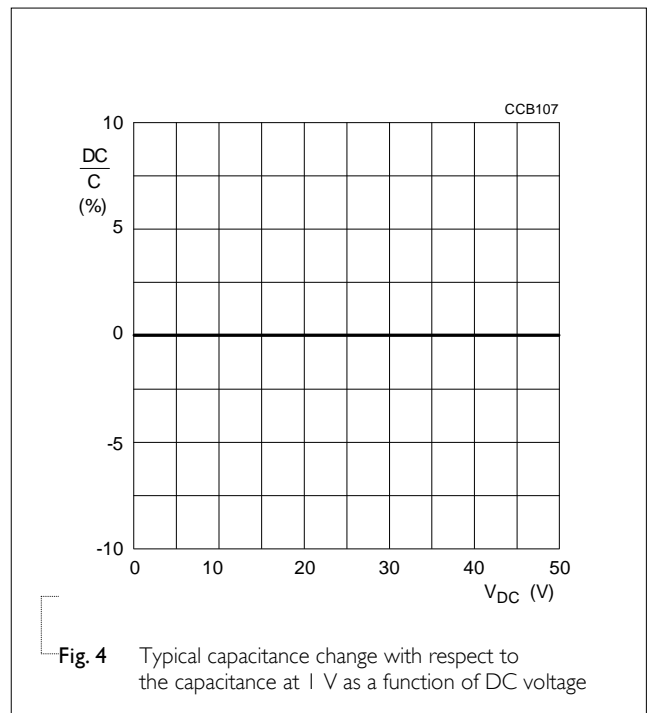
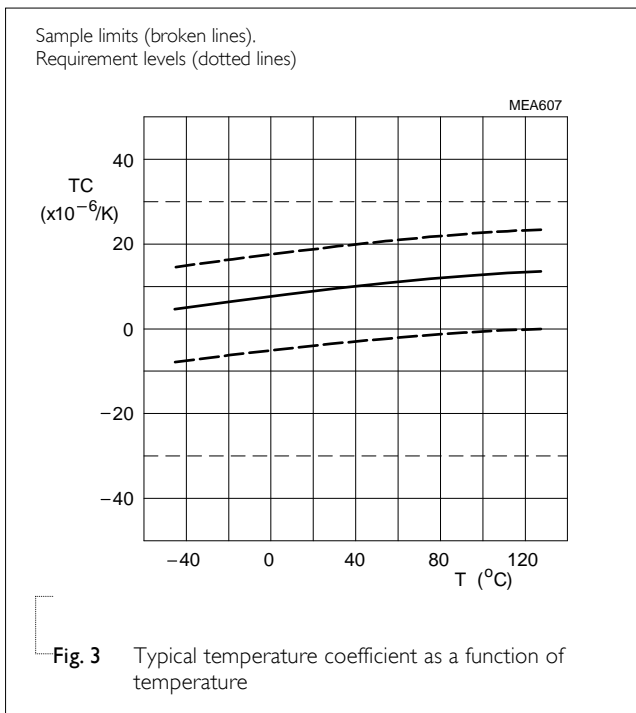

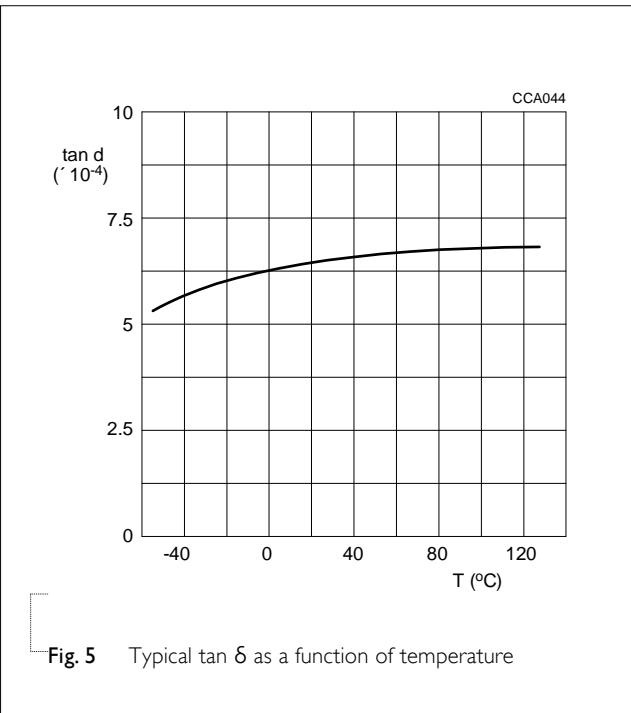

SOLDERING RECOMMENDATION

Table 8

SOLDERING METHOD	SIZE 0201	0402	0603	0805	1206	≥ 1210
Reflow	Reflow only	≥ 0.1 μF	≥ 1.0 μF	≥ 2.2 μF	≥ 4.7 μF	Reflow only
Reflow/Wave	---	< 0.1 μF	< 1.0 μF	< 2.2 μF	< 4.7 μF	---

TESTS AND REQUIREMENTS

Table 9 Test procedures and requirements

TEST	TEST METHOD	PROCEDURE	REQUIREMENTS												
Mounting	IEC 60384-21/22	4.3 The capacitors may be mounted on printed-circuit boards or ceramic substrates	No visible damage												
Visual inspection and dimension check		4.4 Any applicable method using × 10 magnification	In accordance with specification												
Capacitance		4.5.1 Class I: f = 1 MHz for C ≤ 1 nF, measuring at voltage 1 V _{rms} at 20 °C f = 1 KHz for C > 1 nF, measuring at voltage 1 V _{rms} at 20 °C	Within specified tolerance												
Dissipation factor (D.F.)		4.5.2 Class I: f = 1 MHz for C ≤ 1 nF, measuring at voltage 1 V _{rms} at 20 °C f = 1 KHz for C > 1 nF, measuring at voltage 1 V _{rms} at 20 °C	In accordance with specification												
Insulation resistance		4.5.3 At U _r (DC) for 1 minute	In accordance with specification												
Temperature coefficient		4.6 Capacitance shall be measured by the steps shown in the following table. The capacitance change should be measured after 5 min at each specified temperature stage.	<General purpose series> Class I: Δ C/C: ±30ppm Class2: X7R: Δ C/C: ±15% Y5V: Δ C/C: 22~-82%												
		<table border="1"> <thead> <tr> <th>Step</th> <th>Temperature(°C)</th> </tr> </thead> <tbody> <tr> <td>a</td> <td>25±2</td> </tr> <tr> <td>b</td> <td>Lower temperature±3°C</td> </tr> <tr> <td>c</td> <td>25±2</td> </tr> <tr> <td>d</td> <td>Upper Temperature±2°C</td> </tr> <tr> <td>e</td> <td>25±2</td> </tr> </tbody> </table>	Step	Temperature(°C)	a	25±2	b	Lower temperature±3°C	c	25±2	d	Upper Temperature±2°C	e	25±2	<High Capacitance series> Class2: X7R/X5R: Δ C/C: ±15% Y5V: Δ C/C: 22~-82%
Step	Temperature(°C)														
a	25±2														
b	Lower temperature±3°C														
c	25±2														
d	Upper Temperature±2°C														
e	25±2														
		(1) Class I Temperature Coefficient shall be calculated from the formula as below Temp, Coefficient = $\frac{C2 - C1}{C1 \times \Delta T} \times 10^6$ [ppm/°C] C1: Capacitance at step c C2: Capacitance at 125°C ΔT: 100°C (=125°C-25°C)													
		(2) Class II Capacitance Change shall be calculated from the formula as below $\Delta C = \frac{C2 - C1}{C1} \times 100\%$ C1: Capacitance at step c C2: Capacitance at step b or d													

TEST	TEST METHOD	PROCEDURE	REQUIREMENTS
Adhesion	4.7	A force applied for 10 seconds to the line joining the terminations and in a plane parallel to the substrate	Force size ≥ 0603: 5N size = 0402: 2.5N size = 0201: 1N
Bond strength of plating on end face	4.8	Mounting in accordance with IEC 60384-22 paragraph 4.3 Conditions: bending 1 mm at a rate of 1 mm/s, radius jig 5 mm	No visible damage <General purpose series> ΔC/C Class I: NPO: within ±1% or 0.5 pF whichever is greater
Resistance to soldering heat	IEC 60384-21/22 4.9	Precondition: 150 +0/-10 °C for 1 hour, then keep for 24 ±1 hours at room temperature Preheating: for size ≤ 1206: 120 °C to 150 °C for 1 minute Preheating: for size >1206: 100 °C to 120 °C for 1 minute and 170 °C to 200 °C for 1 minute Solder bath temperature: 260 ±5 °C Dipping time: 10 ±0.5 seconds Recovery time: 24 ±2 hours	Dissolution of the end face plating shall not exceed 25% of the length of the edge concerned <General purpose series> ΔC/C Class I: NPO: within ±0.5% or 0.5 pF whichever is greater D.F. within initial specified value R _{ins} within initial specified value
Solderability	4.10	Preheated the temperature of 80 °C to 140 °C and maintained for 30 seconds to 60 seconds. 1. Temperature: 235±5°C / Dipping time: 2 ±0.5 s 2. Temperature: 245±5°C / Dipping time: 3 ±0.5 s (lead free)Depth of immersion: 10mm	The solder should cover over 95% of the critical area of each termination
Rapid change of temperature	4.11	Preconditioning: 150 +0/-10 °C for 1 hour, then keep for 24 ±1 hours at room temperature 5 cycles with following detail: 30 minutes at lower category temperature 30 minutes at upper category temperature Recovery time 24 ±2 hours	No visual damage <General purpose series> ΔC/C Class I: NPO: within ±1% or 1 pF whichever is greater D.F. meet initial specified value R _{ins} meet initial specified value

TEST	TEST METHOD	PROCEDURE	REQUIREMENTS
Damp heat with U_r load	IEC 60384-21/22	<p>4.13</p> <ol style="list-style-type: none"> Preconditioning, class 2 only: 150 +0/-10 °C /1 hour, then keep for 24 ±1 hour at room temp Initial measure: Spec: refer to initial spec C, D, IR Damp heat test: 500 ±12 hours at 40 ±2 °C; 90 to 95% R.H. 1.0 U_r applied Recovery: Class I: 6 to 24 hours Final measure: C, D, IR <p>P.S. If the capacitance value is less than the minimum value permitted, then after the other measurements have been made the capacitor shall be preconditioned according to "IEC 60384 4.1" and then the requirement shall be met.</p>	<p>No visual damage after recovery</p> <hr/> <p><General purpose series> $\Delta C/C$ Class I: NP0: within ±2% or 1 pF whichever is greater D.F. Class I: NP0: ≤ 2 x specified value R_{ins} Class I: NP0: ≥ 2,500 MΩ or $R_{ins} \times C_r \geq 25s$ whichever is less</p>
Endurance		<p>4.14</p> <ol style="list-style-type: none"> Preconditioning, class 2 only: 150 +0/-10 °C /1 hour, then keep for 24 ±1 hour at room temp Initial measure: Spec: refer to initial spec C, D, IR Endurance test: Temperature: NP0: 125 °C Specified stress voltage applied for 1,000 hours: Applied 2.0 x U_r for general product. Recovery time: 24 ±2 hours Final measure: C, D, IR <p>P.S. If the capacitance value is less than the minimum value permitted, then after the other measurements have been made the capacitor shall be preconditioned according to "IEC 60384 4.1" and then the requirement shall be met.</p>	<p>No visual damage</p> <hr/> <p><General purpose series> $\Delta C/C$ Class I: NP0: within ±2% or 1 pF whichever is greater D.F. Class I: NP0: ≤ 2 x specified value R_{ins} Class I: NP0: ≥ 4,000 MΩ or $R_{ins} \times C_r \geq 40s$ whichever is less</p>
Voltage proof	IEC 60384-1	<p>4.6</p> <p>Specified stress voltage applied for 1 minute</p> <p>$U_r \leq 100$ V: series applied 2.5 U_r 100 V < $U_r \leq 200$ V series applied (1.5 U_r + 100) 200 V < $U_r \leq 500$ V series applied (1.3 U_r + 100) $U_r > 500$ V: 1.3 U_r I: 7.5 mA</p>	<p>No breakdown or flashover</p>

REVISION HISTORY

REVISION	DATE	CHANGE NOTIFICATION	DESCRIPTION
Version 18	Jun. 14, 2023	-	- Update 1206/12nF to 47nF dimension
Version 17	Jul. 29, 2019	-	- Update 0805/10nF dimension
Version 16	Mar. 7, 2017	-	- 0805 L4 spec updated
Version 15	Nov. 21, 2016	-	- Product range updated
Version 14	Jul. 22, 2016	-	- Add 0805/8.2nF and 10nF/ 16V to 50V, T=1.25mm
Version 13	May. 16, 2016	-	- Product range updated
Version 12	Feb. 16, 2016	-	- Product range updated
Version 11	Sep. 11, 2014	-	- Product range updated
Version 10	Feb. 18, 2014	-	- Product range updated
Version 9	Jun. 17, 2013	-	- Product range updated
Version 8	Aug 05, 2011	-	- Dimension updated
Version 7	Jun 14, 2011	-	- Size 1210 T=1.0mm SPQ added - Dimension updated
Version 6	Jan 06, 2011	-	- Dimension updated
Version 5	Dec 29, 2010	-	- Dimension updated
Version 4	Nov 23, 2010	-	- Dimension updated
Version 3	Apr 20, 2010	-	- The statement of "Halogen Free" on the cover added - Dimension updated
Version 2	Oct 26, 2009	-	- Typo updated
Version 1	Jun 02, 2009	-	- 12NC code updated
Version 0	Apr 15, 2009	-	- New datasheet for general purpose NPO series with RoHS compliant - Replace the "16V to 50V" part of pdf files: NPO_16V_7, NPO_16V-to-100V_6, NPO_25V_7, NPO_50-to-500V_11 - Combine 0201 from pdf files: UP-NPOX5RX7RY5V_0201_6.3-to-50V_2 and UY-NPOX5RX7RY5V_0201_6.3-to-50V_2 - Define global part number - Description of "Halogen Free compliant" added - Test method and procedure updated

LEGAL DISCLAIMER

YAGEO, its distributors and agents (collectively, "YAGEO"), hereby disclaims any and all liabilities for any errors, inaccuracies or incompleteness contained in any product related information, including but not limited to product specifications, datasheets, pictures and/or graphics. YAGEO may make changes, modifications and/or improvements to product related information at any time and without notice.

YAGEO makes no representation, warranty, and/or guarantee about the fitness of its products for any particular purpose or the continuing production of any of its products. To the maximum extent permitted by law, YAGEO disclaims (i) any and all liability arising out of the application or use of any YAGEO product, (ii) any and all liability, including without limitation special, consequential or incidental damages, and (iii) any and all implied warranties, including warranties of fitness for a particular purpose, non-infringement and merchantability.

YAGEO products are designed for general purpose applications under normal operation and usage conditions. Please contact YAGEO for the applications listed below which require especially high reliability for the prevention of defects which might directly cause damage to the third party's life, body or property: Aerospace equipment (artificial satellite, rocket, etc.), Atomic energy-related equipment, Aviation equipment, Disaster prevention equipment, crime prevention equipment, Electric heating apparatus, burning equipment, Highly public information network equipment, data-processing equipment, Medical devices, Military equipment, Power generation control equipment, Safety equipment, Traffic signal equipment, Transportation equipment and Undersea equipment, or for any other application or use in which the failure of YAGEO products could result in personal injury or death, or serious property damage. Particularly **YAGEO Corporation and its affiliates do not recommend the use of commercial or automotive grade products for high reliability applications or manned space flight.**

Information provided here is intended to indicate product specifications only. YAGEO reserves all the rights for revising this content without further notification, as long as products are unchanged. Any product change will be announced by PCN.



Looking for pricing, stock, or lifecycle information?

Click below to explore more details on WIN SOURCE:

 [View CC0603FRNPO9BN181 on WIN SOURCE](#)

 [Yageo Information](#)

Optimize Your Supply Chain with WIN SOURCE Solutions

-  Global Sourcing Solution
-  Obsolete Management
-  Cost Control Management
-  Shortage Management
-  Alternative Solution
-  Excess Inventory Management