



THE DATASHEET OF
818-22-006-10-005101



SPRING-LOADED CONNECTORS

SERIES 816 & 818 • .100" GRID THROUGH-HOLE MOUNT, MID PROFILE • SINGLE AND DOUBLE ROW STRIPS

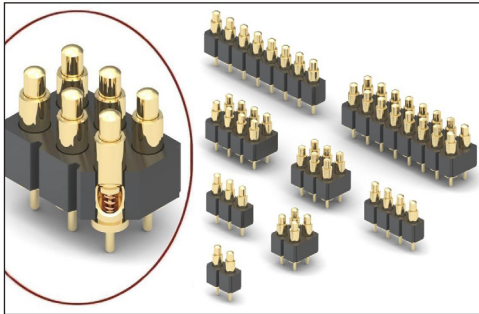

- Modular contacts for use on .100" grid, available in ten heights from .255" to .430", supplied in single and double row contact strips
- Precision-machined piston / base and gold-plated components assure up to 1,000,000 cycle life durability
- Pistons have a .0275" mid stroke & .055" max. stroke
- Low resistance, high current contacts are rated at 2 amps continuous, 3 amps peak
- High temperature thermoplastic insulators are suitable for surface mount processes
- Both 816 & 818 series contact strips are designed for manual placement into $\varnothing .030" \pm .003"$ plated through-holes in the circuit board prior to intrusive reflow soldering

SINGLE ROW Series 816...00X101

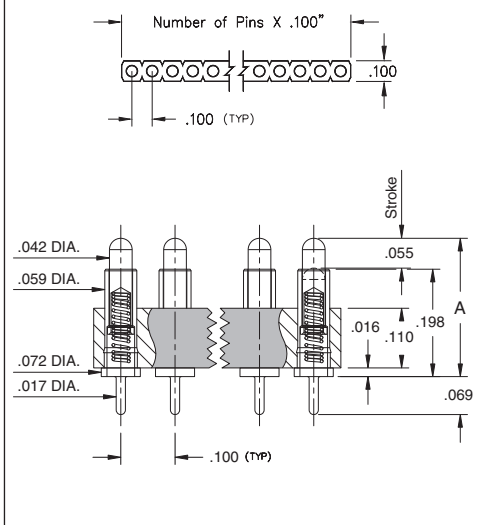

ORDERING INFORMATION

Single Row Series 816...00X101

816-22-0XX-10-00X101
 Specify number of contacts 02-64 Specify contact style 0-9

Double Row Series 818...00X101

818-22-0XX-10-00X101
 Specify number of contacts 04-72 Specify contact style 0-9

CONTACT STYLE	INITIAL HEIGHT A	CONTACT STYLE	INITIAL HEIGHT A
0	.255	5	.350
1	.275	6	.370
2	.295	7	.390
3	.315	8	.410
4	.335	9	.430

DOUBLE ROW Series 818...00X101

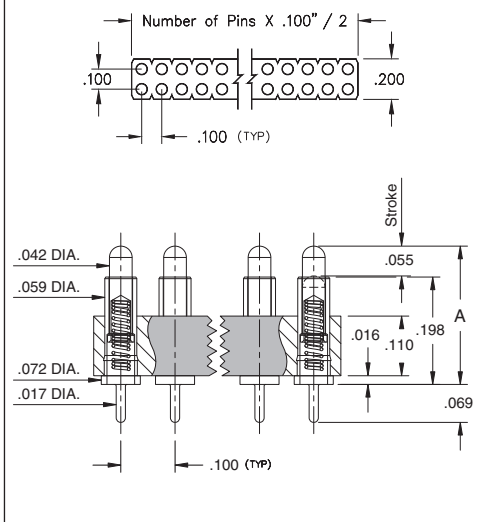

Technical Specifications

Materials:

Contact piston & base: Machined copper alloy plated 20 μ " gold over 100 μ " nickel
 Spring: Beryllium copper-plated 10 μ " gold
 Insulator: High temperature thermoplastic, rated UL94 V-0

Mechanical:

Spring force @ initial height (A): 25 grams
 Spring force @ mid stroke (.0275"): 60 grams
 Durability: Up to 1,000,000 cycles

Electrical:

Voltage rating: 100Vrms/150Vdc
 Current rating: 2A (continuous), 3A (peak) per contact
 Contact resistance: 20m Ω max.
 Insulation resistance: 10,000M Ω min.
 Dielectric strength: 700Vrms min.
 Capacitance: 1pF max.

RoHS - 2
2011/65/EU



Looking for pricing, stock, or lifecycle information?

Click below to explore more details on WIN SOURCE:

- ⊖ [View 818-22-006-10-005101 on WIN SOURCE](#)
- ⊖ [Mill-Max Manufacturing Corp.](#) Information

Optimize Your Supply Chain with WIN SOURCE Solutions

- ✓ Global Sourcing Solution
- ✓ Obsolete Management
- ✓ Cost Control Management
- ✓ Shortage Management
- ✓ Alternative Solution
- ✓ Excess Inventory Management