



**THE DATASHEET OF  
Y1629500R000T9R**



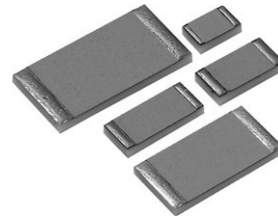
## Ultra High-Precision Z-Foil Flip Chip Resistor with TCR of $\pm 0.2$ ppm/ $^{\circ}\text{C}$ , 35% Space Saving vs. Wraparound Design and PCR of 5 ppm at Rated Power

### FEATURES

- Temperature coefficient of resistance (TCR):  $\pm 0.2$  ppm/ $^{\circ}\text{C}$  typical ( $-55^{\circ}\text{C}$  to  $+125^{\circ}\text{C}$ ,  $+25^{\circ}\text{C}$  ref.)
- Tolerance: to  $\pm 0.01\%$  (100 ppm)
- Power coefficient “ $\Delta R$  due to self heating” 5 ppm at rated power
- Load-life stability ( $70^{\circ}\text{C}$  for 2000 h):  $\pm 0.005\%$  (50 ppm)
- Power rating to: 600 mW at  $+70^{\circ}\text{C}$
- Electrostatic discharge (ESD): at least to 25 kV
- Resistance range: 5  $\Omega$  to 125 k $\Omega$  (for lower and higher values, please contact us)
- Bulk Metal<sup>®</sup> Foil resistors are not restricted to standard values; specific “as required” values (e.g., 1K2345 vs. 1K)
- Non-inductive, non-capacitive design
- Thermal stabilization time:  $< 1$  s (within 10 ppm of steady state value)
- Short time overload:  $\leq 0.005\%$  (50 ppm)
- Non hot spot design
- Rise time: 1 ns effectively no ringing
- Current noise:  $< 0.010$   $\mu\text{V}_{\text{rms}}$  / V of applied voltage ( $< -40$  dB)
- Voltage coefficient:  $< 0.1$  ppm/V
- Non-inductive:  $< 0.08$   $\mu\text{H}$
- Terminal finishes available: lead (Pb)-free, tin/lead alloy
- Matched sets are available per request
- Rapid prototype sample quantities are available.  
For more information, please contact us at foil@vpgsensors.com

### INTRODUCTION

Based on VFR’s Bulk Metal Z-Foil technology, the VFCP Series (foil resistor flip-chip) excels over all previous stability standards for precision resistors with an order of magnitude improvement in high-temperature stability, load-life stability, and moisture resistance. These new benchmark levels of performance provide design engineers with the tools to build circuits not previously achievable while reducing costs and space in the most critical applications by eliminating the need for corrective circuitry and reducing the large land patterns needed



Pb-free  
Available  
**RoHS\***  
COMPLIANT

for a wrap-around configuration. The device’s flip-chip configuration saves up to 35% PCB space compared with a surface-mount chip with wraparound terminations while also providing better strain relief to eliminate cracked substrates and board delamination.

In addition to its remarkably improved load-life stability, the VFCP Series is noise-free and provides ESD protection of 25 kV or more for increased reliability. The device’s solid element alloy is matched to the substrate, forming a single entity with balanced resistance versus temperature characteristics for an unusually low and predictable TCR over a wide temperature range from  $-55^{\circ}\text{C}$  to more than  $+125^{\circ}\text{C}$ . The adhesive that holds the foil to the flat substrate withstands high temperatures, pulsing power, moisture incursions, shock and vibration, and low-temperature exposure while still holding securely to the foil element. Resistance patterns are photo-etched into the element to permit the trimming of resistance values to very tight tolerances as low as 0.01%.

The Flip Chips devices are qualified as anti-sulfurated resistors for use in environments with high levels of contamination. Such environments include alternative energy applications, industrial control systems, sensors, RTDs, electric instrumentation, weather and communication base stations, and any electronic appliance used in high concentrations of sulfur. The combination of flip-chip terminations and Z-Foil construction and materials results in the most stable resistors available, requiring the lowest error allowance. This means that more error allowance can be transferred to active devices—resulting in lower costs—or applied to the foil resistors themselves, allowing for looser initial tolerances than would be required for other resistor technologies.

### RELATED VIDEO

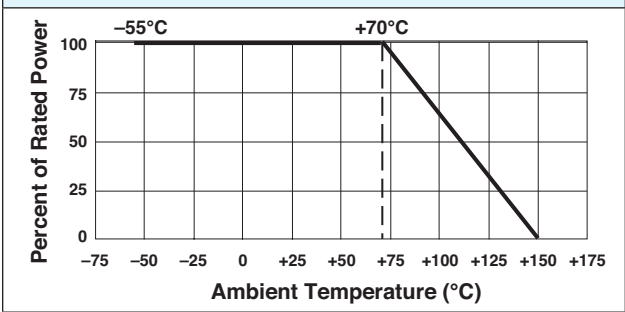
Refer to [Bulk Metal<sup>®</sup> Foil Resistor TCR Performance \(Product Demo\)](#).

\* This datasheet provides information about parts that are RoHS-compliant and/or parts that are non-RoHS-compliant. For example, parts with lead (Pb) terminations are not RoHS compliant. Please see the information/tables in this datasheet for details.

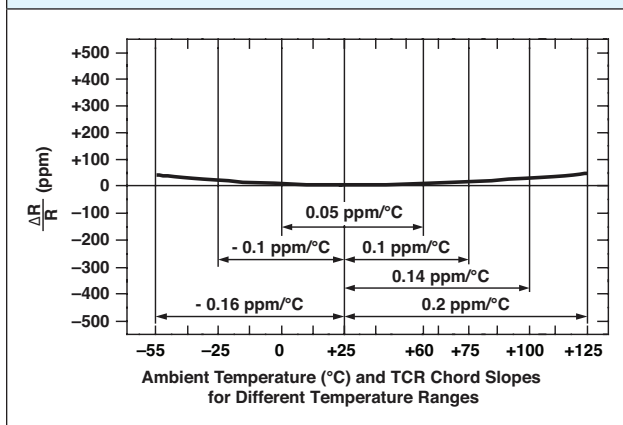
**TABLE 1 – TOLERANCE AND TCR VS. RESISTANCE VALUE**

Resistance Value (Ω)	Tolerance (%)	Typical TCR and Max. Spread (-55°C to +125°C, +25°C Ref.) (ppm/°C)
250 to 125k	±0.01%	±0.2 ±1.6
100 to <250	±0.02%	±0.2 ±1.6
50 to <100	±0.05%	±0.2 ±1.8
25 to <50	±0.1%	±0.2 ±2.8
10 to <25	±0.25%	±0.2 ±2.8
5 to <10	±0.5%	±0.2 ±7.8

**FIGURE 1 – POWER DERATING CURVE**

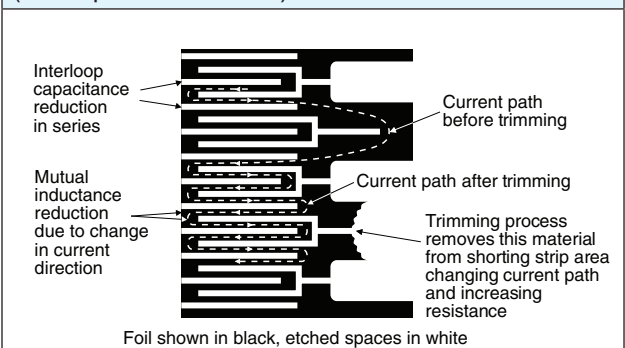


**FIGURE 2 – NOMINAL RESISTANCE/TEMPERATURE CURVE**



**Note**  
The TCR values for <100 Ω are influenced by the termination composition and result in deviation from this curve.

**FIGURE 3 – TRIMMING TO VALUES (conceptual illustration)**



**Note**  
To acquire a precision resistance value, the Bulk Metal Foil chip is trimmed by selectively removing built-in “shorting bars.” To increase the resistance in known increments, marked areas are cut, producing progressively smaller increases in resistance. This method reduces the effect of “hot spots” and improves the long-term stability of VFR resistors.

**TABLE 2 – MODEL SELECTION**

Chip Size	Rated Power at +70°C (mW)	Maximum Voltage Rating ( $\leq \sqrt{P \times R}$ )	Resistance Range (Ω)	Max. Weight (mg)
0805	100 mW	28 V	5 to 8k	5.2
1206	250 mW	79 V	5 to 25k	10.3
1506	300 mW	95 V	5 to 30k	12
2010	400 mW	167 V	5 to 70k	25
2512	600 mW	220 V	5 to 125k	35

**TABLE 3 – LOAD-LIFE STABILITY (+70°C for 2000 h)**

Chip Size	MAXIMUM ΔR LIMITS
0805	±0.005% at 50 mW ±0.01% at 100 mW
1206	±0.005% at 150 mW ±0.01% at 250 mW
1506	±0.005% at 150 mW ±0.01% at 300 mW
2010	±0.005% at 200 mW ±0.01% at 400 mW
2512	±0.005% at 500 mW ±0.01% at 600 mW

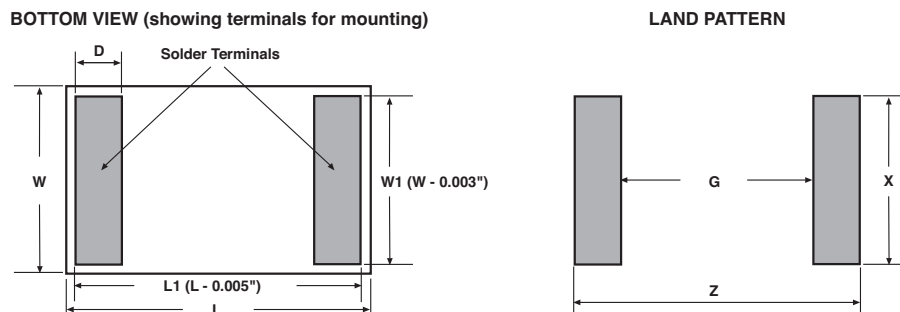
**TABLE 4—PERFORMANCE SPECIFICATIONS**

Test or Condition	MIL-PRF-55342 Characteristic E $\Delta R$ Limits	Typical $\Delta R$ Limits	Maximum $\Delta R$ Limits <sup>(1)</sup>
Thermal Shock	±0.1%	±0.005% (50 ppm)	± 0.01% (100 ppm)
Low Temperature Operation	±0.1%	±0.005% (50 ppm)	± 0.01% (100 ppm)
Short Time Overload	±0.1%	±0.005% (50 ppm)	± 0.01% (100 ppm)
High Temperature Exposure	±0.1%	±0.01% (100 ppm)	±0.02% (200 ppm)
Resistance to Soldering Heat	±0.2%	±0.005% (50 ppm)	±0.015% (150 ppm)
Moisture Resistance	±0.2%	±0.005% (50 ppm)	±0.03% (300 ppm)
Load Life Stability +70°C for 2000 hours at Rated Power	±0.5%	±0.005% (50 ppm)	±0.01% (100 ppm)

**Note**

(1) As shown +0.01 ohms ( $\Omega$ ) to allow for measurement errors at low values.

**TABLE 5—DIMENSIONS AND LAND PATTERN** in inches (millimeters)



**Note:** Recommended stencil thickness 0.2 mm/0.00787 inch minimum

Chip Size	L ±0.005 (0.13)	W ±0.005 (0.13)	Thickness Maximum	D ±0.005 (0.13)	Z	G	X
0805	0.079 (2.01)	0.049 (1.24)	0.025 (0.64)	0.010 (0.25)	0.078 (1.98)	0.053 (1.35)	0.049 (1.24)
1206	0.126 (3.20)	0.062 (1.57)	0.025 (0.64)	0.015 (0.38)	0.125 (3.18)	0.090 (2.29)	0.062 (1.57)
1506	0.150 (3.81)	0.062 (1.57)	0.025 (0.64)	0.012 (0.30)	0.150 (3.81)	0.120 (3.05)	0.062 (1.57)
2010	0.200 (5.08)	0.100 (2.54)	0.025 (0.64)	0.020 (0.51)	0.199 (5.05)	0.153 (3.89)	0.100 (2.54)
2512	0.250 (6.35)	0.126 (3.20)	0.025 (0.64)	0.024 (0.61)	0.250 (6.35)	0.196 (4.98)	0.126 (3.20)

**Notes**

Avoid the use of those cleaning agents that could attack epoxy resins, which form part of the resistor construction. Vacuum pick-up is recommended for handling. Soldering iron not recommended.

**RELATED PRODUCT TRAINING MODULE**

Refer to [Precision Resistors—There is more to resistor precision than meets the eye.](#)

**RELATED VIDEO**

Refer to [Bulk Metal® Foil Resistor Accelerated Life Test \(Product Demo\).](#)

**HARMONIC DISTORTION**

Harmonic distortion is an important consideration in the choice of precision resistors for sensitive applications. A

significant signal voltage across the resistor may change the resistance value depending on the construction, material, and size. Under these conditions Bulk Metal Foil resistors behave more linearly than other resistor types.

**FLOWER OF SULFUR**

ASTM B 809, also known as flower of sulfur, is a test to determine the porosity of metallic coating using humid sulfur vapor. This vapor can penetrate conformal coatings and cause damage to the device when it reacts with lower layers of silver. Surface-mount Bulk Metal Foil chip resistors avoid this problem with a special coating that

# VFCP Series (Z-Foil)

## (0805, 1206, 1506, 2010, 2512)

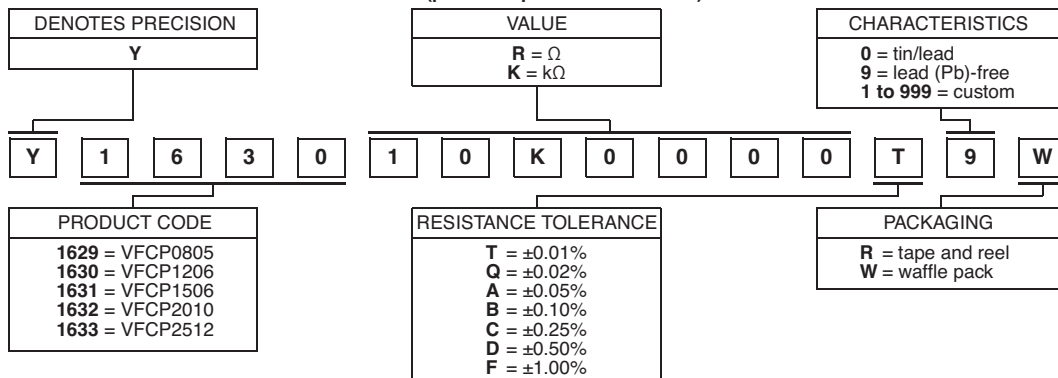
is proven to be reliable in extreme environments and even against sulfur. The flower of sulfur test is especially relevant to designers of circuits used in alternative energy and industrial applications, where environmental pollution is a constant concern. Analog circuitry in these applications almost always operates under severe environmental, thermal, and mechanical conditions, and must withstand frequent and extended service by professionals and novices alike. The picture is further complicated by tough regulatory restrictions and high consumer expectations. VFR received a steady stream of customer inquiries, which led to more focus on anti-sulfurated resistor research and development. As a result we have qualified our surface-mount foil chip resistors as “antisulfurated resistors.” These resistors are capable of exposure to sulfurous environments without damage. Beyond alternative energy, applications include industrial control systems, sensors, RTDs, electric instrumentation, weather and communication base stations. These resistors are also suited for electronic appliances used in high concentrations of sulfur.

### POWER COEFFICIENT OF RESISTANCE (PCR)

The TCR of a resistor for a given temperature range is established by measuring the resistance at two different ambient temperatures: at room temperature and in a cooling chamber or oven. The ratio of relative resistance change and temperature difference gives the slope of  $DR/R = f(T)$  curve. This slope is usually expressed in parts per million per degree Centigrade (ppm/°C). In these conditions, a uniform temperature is achieved in the measured resistance. In practice, however, the temperature rise of the resistor is also partially due to self-heating as a result of the power it is dissipating. As stipulated by the Joule effect, when current flows through a resistance, there will be an associated generation of a heat flow and of a temperature gradient. Therefore, the TCR alone does not provide the actual resistance change for precision resistor. Hence, another metric is introduced to incorporate this inherent characteristic—the Power Coefficient of Resistance (PCR). PCR is expressed in parts per million per Watt or in ppm at rated power. In the case of Z-based Bulk Metal® Foil, the PCR is 5 ppm typical at rated power or 4 ppm per Watt typical for power resistors.

**TABLE 6—GLOBAL PART NUMBER INFORMATION<sup>(1)</sup>**

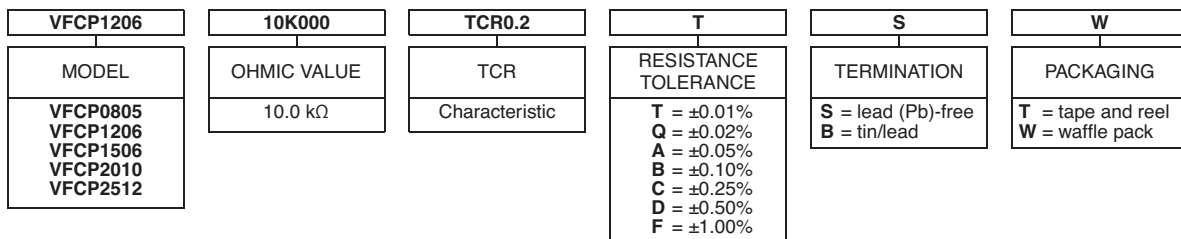
NEW GLOBAL PART NUMBER: Y163010K000T9W (preferred part number format)



FOR EXAMPLE: ABOVE GLOBAL ORDER Y1630 10K000 T 9 W:

TYPE: VFCP1206  
VALUE: 10.0 kΩ  
ABSOLUTE TOLERANCE: ±0.01%  
TERMINATION: lead (Pb)-free  
PACKAGING: waffle pack

HISTORICAL PART NUMBER: VFCP1206 10K000 TCR0.2 T S W (will continue to be used)



**Note**

(1) For non-standard requests, please contact Application Engineering



## **Disclaimer**

ALL PRODUCTS, PRODUCT SPECIFICATIONS AND DATA ARE SUBJECT TO CHANGE WITHOUT NOTICE.

Vishay Precision Group, Inc., its affiliates, agents, and employees, and all persons acting on its or their behalf (collectively, "VPG"), disclaim any and all liability for any errors, inaccuracies or incompleteness contained herein or in any other disclosure relating to any product.

The product specifications do not expand or otherwise modify VPG's terms and conditions of purchase, including but not limited to, the warranty expressed therein.

VPG makes no warranty, representation or guarantee other than as set forth in the terms and conditions of purchase. **To the maximum extent permitted by applicable law, VPG disclaims (i) any and all liability arising out of the application or use of any product, (ii) any and all liability, including without limitation special, consequential or incidental damages, and (iii) any and all implied warranties, including warranties of fitness for particular purpose, non-infringement and merchantability.**

Information provided in datasheets and/or specifications may vary from actual results in different applications and performance may vary over time. Statements regarding the suitability of products for certain types of applications are based on VPG's knowledge of typical requirements that are often placed on VPG products. It is the customer's responsibility to validate that a particular product with the properties described in the product specification is suitable for use in a particular application. You should ensure you have the current version of the relevant information by contacting VPG prior to performing installation or use of the product, such as on our website at [vpgsensors.com](http://vpgsensors.com).

No license, express, implied, or otherwise, to any intellectual property rights is granted by this document, or by any conduct of VPG.



The products shown herein are not designed for use in life-saving or life-sustaining applications unless otherwise expressly indicated. Customers using or selling VPG products not expressly indicated for use in such applications do so entirely at their own risk and agree to fully indemnify VPG for any damages arising or resulting from such use or sale. Please contact authorized VPG personnel to obtain written terms and conditions regarding products designed for such applications.

Product names and markings noted herein may be trademarks of their respective owners.

Copyright Vishay Precision Group, Inc., 2014. All rights reserved.

## Looking for pricing, stock, or lifecycle information?

Click below to explore more details on WIN SOURCE:

-  [View Y1629500R000T9R on WIN SOURCE](#)
-  [VPG Foil Resistors Information](#)

## Optimize Your Supply Chain with WIN SOURCE Solutions

-  Global Sourcing Solution
-  Obsolete Management
-  Cost Control Management
-  Shortage Management
-  Alternative Solution
-  Excess Inventory Management