



**THE DATASHEET OF
Y4022100R000Q0R**



Ultra High-Precision FRSM Wrap-Around Chip Resistors, Z1 Foil Technology Configuration with TCR of ± 0.05 ppm/ $^{\circ}$ C and Improved Load-Life Stability of 0.0025% (25 ppm)

FEATURES

- Temperature coefficient of resistance (TCR):
 ± 0.05 ppm/ $^{\circ}$ C typical (0 $^{\circ}$ C to +60 $^{\circ}$ C)
 ± 0.2 ppm/ $^{\circ}$ C typical (-55 $^{\circ}$ C to +125 $^{\circ}$ C, +25 $^{\circ}$ C ref.)
- Resistance tolerance: to $\pm 0.01\%$
- Power coefficient “ ΔR due to self heating”: 5 ppm at rated power
- Power rating: to 750 mW at +70 $^{\circ}$ C
- **Load life stability:**
 $\pm 0.0025\%$ typical at 70 $^{\circ}$ C, 2000 h at rated power
 $\pm 0.005\%$ typical at 70 $^{\circ}$ C, 10,000 h at rated power
- Resistance range: 5 Ω to 125 k Ω (for higher and lower values, please contact us)
- AEC-Q200 qualified
- Bulk Metal Foil resistors are not restricted to standard values; specific “as required” values (e.g., 1K2345 vs. 1K)
- Thermal stabilization time: <1 s (nominal value achieved within 10 ppm of steady state value)
- Electrostatic discharge (ESD): at least to 25 kV
- Short time overload: $\leq 0.005\%$ typical
- Rise time: 1 ns, effectively no ringing
- Current noise: <0.010 μ V_{RMS}/V of applied voltage (<-40 dB)
- Voltage coefficient: <0.1 ppm/V (resistance values above 10 k Ω)
- Non-inductive: 0.08 μ H
- Non-hot spot design
- Terminal finishes available: lead (Pb)-free, tin/lead alloy*
- Matched sets are available on request
- Screening in accordance with EEE-INST-002 and MIL-PRF-55342 available (see datasheet resistor models 303261 to 303266)
- Quick prototype quantities available, please contact us.

* This datasheet provides information about parts that are RoHS-compliant and/or parts that are non-RoHS-compliant. For example, parts with lead (Pb) terminations are not RoHS compliant. Please see the information/tables in this datasheet for details.

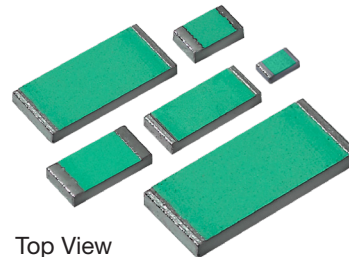

Top View



INTRODUCTION

The ultra high precision FRSM is based on the new generation Z1 Foil Technology of the Bulk Metal® Foil resistor elements by VFR Resistors (a VPG brand), which makes these resistors virtually insensitive to destabilizing factors (for more information about stresses and destabilizing factors please refer to Tech Note 102: www.vishaypg.com/doc?63135). Their element, based on the Z1 Foil Technology is a solid alloy that displays the desirable bulk properties of its parent material; thus, it is inherently stable (remarkably improved load life stability of 25 ppm), noise-free and withstands ESD to 25 kV or more. The alloy is matched to the substrate and forms a single entity with balanced temperature characteristics for an unusually low and predictable TCR over a wide range from -55 $^{\circ}$ C to more than 175 $^{\circ}$ C. Resistance patterns are photo-etched to permit trimming of resistance values to very tight tolerances.

Our application engineering department is available to advise and make recommendations. For non-standard technical requirements and special applications, please contact us using the e-mail address in the footer below.

Table 1 – Tolerance and TCR vs. Resistance Value

Resistance Value (Ω)	Tolerance (%)	Typical TCR and Spread (ppm/ $^{\circ}$ C) ⁽¹⁾
250 to 125k	$\pm 0.01\%$	$\pm 0.05 \pm 0.5$
100 to <250	$\pm 0.02\%$	
50 to <100	$\pm 0.05\%$	
25 to <50	$\pm 0.1\%$	
10 to <25	$\pm 0.25\%$	
5 to <10	$\pm 0.5\%$	

⁽¹⁾ From 0 $^{\circ}$ C to 60 $^{\circ}$ C

ABOUT THE FRSM SERIES

Several factors need to be considered when choosing a resistor for applications that require long term stability, including TCR (ambient temperature), Power TCR (self heating), load-life stability for more than 10K hours (instead of the typical 1000 or 2000 hours load-life), end-of-life tolerance (which is more important than the initial tolerance), thermal EMF (low values, D.C), thermal stabilization and ESD. Some precision resistor technologies such as Precision Thin Film offer designers tight initial tolerances as low as 0.02 % but have poor load life stability, high end-of-life tolerance, long thermal stabilization, high drifts during operational life and ESD sensitivity. Other resistor technologies, such as Wirewounds, provide low absolute TCR and excellent current noise of -40 dB but have high inductance and poor rise time (or thermal lag) for more than a few seconds.

There are essentially only three resistance technologies widely used for precision resistors in military and space applications: Thin Film, Wirewound and Bulk Metal® Foil. Each has its own balance of characteristics and costs that justify its selection in these applications. Thin Films are most cost-efficient within their normal range of characteristics but have the highest TCR, highest noise and have the least stability of the three technologies. Wirewounds have low noise, low TCR and a high level of stability at moderate cost but also have high impedance and slow signal response. Wirewounds can also have a higher power density, but some stability is lost through temperature cycling and load-life when made in smaller configurations. Bulk Metal Foil resistors have the lowest noise, lowest TCR, highest stability and highest speed of any technology but may have a higher cost, depending upon model. With Bulk Metal Foil resistors, savvy designers often save overall by concentrating the circuit stability in the Bulk Metal Foil resistors where exceptional stability allows for use of less-costly active devices—an option not available with other resistor technologies because Bulk Metal Foil foil requires a smaller total error budget through all cumulative resistor life exposures. Also, Bulk Metal Foil often eliminates extra circuitry added merely for the purpose of correcting the limitations of other resistor components. FRSM Bulk Metal Foil resistors, based on new generation technology and improved production methods starting from February 2011, offer designers the complete set of top performance characteristics to simplify circuitry and lower overall system costs by reducing the number of required parts while assuring a better end product. The new series of FRSM feature a long-term load-life stability within 0.0025% after 2000 hours and 0.005% after 10000 hours under full rated power at +70°C, first time in the history of all resistor technologies. In addition to their low absolute TCR of almost zero TCR, the devices offer Power TCR (“ ΔR due to self heating”) to ± 5 ppm at rated power; tight tolerance from 0.01% and thermal EMF of 0.05 $\mu V/^\circ C$.

The causes of resistor drift are listed in Table 4 and the allowances shown are for full scale exposure. The designer may choose to use a percentage of full scale stress factor if the equipment will never see the full scale conditions. For example, a laboratory instrument

that is expected to be permanently installed in an air-conditioned laboratory does not need an end-of-life allowance for excessive heat. There are other reasons for tolerancing the resistors tighter than the initial calculation: Measurement equipment accuracy is traditionally ten times better than the expected accuracy of the devices under test. These tighter tolerance applications require a high precision resistor. Also, the drift of the resistor without any stress factor considerations results in a shift over time that must be considered. FRSMs have the least amount of time shift. The manufacturer’s recommended recalibration cycle is a factor in the saleability of the product and the longer the cycle, the more acceptable the product. Bulk Metal Foil resistors contribute significantly to the longer calibration cycle.

Figure 1 – Power Derating Curve

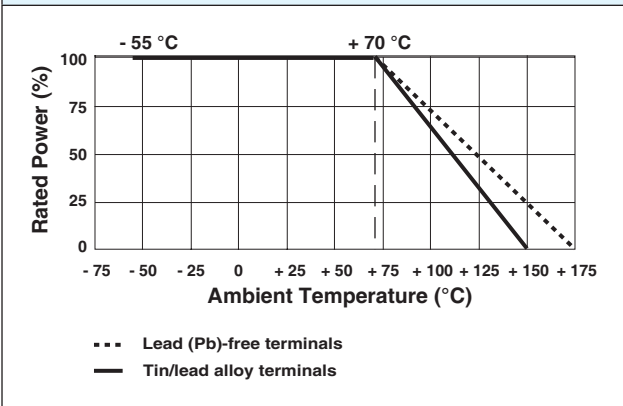
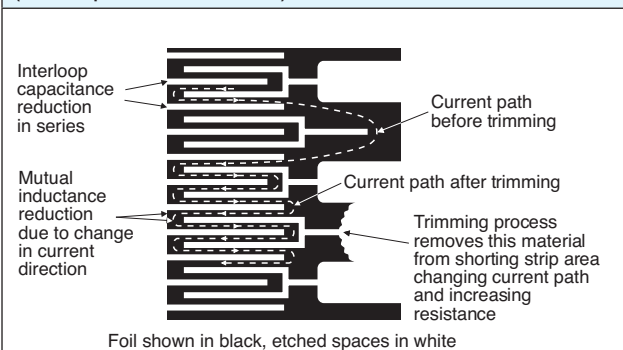

Figure 2 – Trimming to Values (conceptual illustration)



Note

To acquire a precision resistance value, the Bulk Metal® Foil chip is trimmed by selectively removing built-in “shorting bars.” To increase the resistance in known increments, marked areas are cut, producing progressively smaller increases in resistance. This method reduces the effect of “hot spots” and improves the long-term stability of Bulk Metal® Foil resistors.

Figure 3—Typical Resistance/Temperature Curve⁽¹⁾

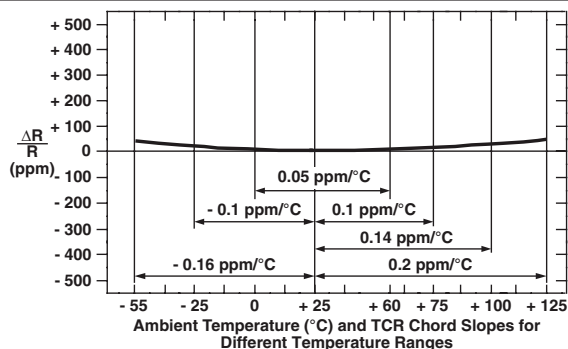

⁽¹⁾ The TCR values for < 100 Ω are influenced by the termination composition and result in deviation from this curve.

Figure 4—Recommended Mounting

1. IR and vapor phase reflow are recommended.
2. Avoid the use of cleaning agents that attack epoxy resins, which form part of the resistor construction.
3. Vacuum pick up is recommended for handling.
4. If the use of a soldering iron becomes necessary, precautionary measures should be taken to avoid any possible damage/overheating of the resistor.

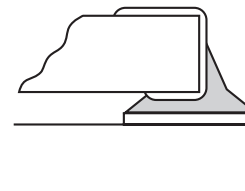

* Recommendation: The solder fillet profile should be such as to avoid running over the top metallization.

Table 2—Specifications⁽¹⁾

Chip Size	Rated Power at +70°C (mW)	Max. Working Voltage ($\leq \sqrt{P \times R}$)	Resistance Range (Ω)	Typ. TCR and Spread, -55°C to +125°C, +25°C Ref. (ppm/°C)	Max. Weight (mg)
0603	100	22 V	100 to 5k	$\pm 0.2 \pm 1.8$ ($\geq 100 \Omega$) $\pm 0.2 \pm 2.8$ (50Ω to $< 100 \Omega$) $\pm 0.2 \pm 3.8$ (10Ω to $< 50 \Omega$) $\pm 0.2 \pm 7.8$ (5Ω to $< 10 \Omega$)	4
0805	200	40 V	5 to 8k		6
1206	300	87 V	5 to 25k		11
1506	300	95 V	5 to 30k		12
2010	500	187 V	5 to 70k		27
2512	750	220 V	5 to 125k		40

⁽¹⁾ For tighter TCR and/or resistance values up to 150k, please contact Application Engineering.

Table 3—Dimensions in inches (millimeters)

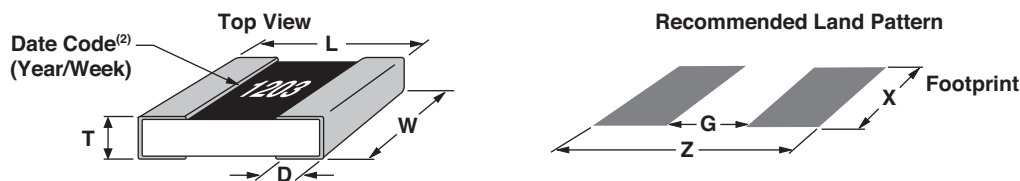

Note: Recommended stencil thickness 0.2 mm/0.00787 inch minimum

Chip Size	L ± 0.005 (0.13)	W ± 0.005 (0.13)	Thickness Maximum	D ± 0.005 (0.13)	Z ⁽¹⁾	G ⁽¹⁾	X ⁽¹⁾
0603	0.063 (1.60)	0.032 (0.81)	0.025 (0.64)	0.011 (0.28)	0.102 (2.59)	0.031 (0.78)	0.031(0.78)
0805	0.080 (2.03)	0.050 (1.27)		0.015 (0.38)	0.122 (3.10)	0.028 (0.71)	0.050 (1.27)
1206	0.126 (3.20)	0.062 (1.57)		0.020 (0.51)	0.175 (4.45)	0.059 (1.50)	0.071 (1.80)
1506	0.150 (3.81)	0.062 (1.57)		0.020 (0.51)	0.199 (5.05)	0.083 (2.11)	0.071 (1.80)
2010	0.198 (5.03)	0.097 (2.46)		0.025 (0.64)	0.247 (6.27)	0.115 (2.92)	0.103 (2.62)
2512	0.249 (6.32)	0.127 (3.23)		0.032 (0.81)	0.291 (7.39)	0.150 (3.81)	0.127 (3.23)

⁽¹⁾ Land Pattern Dimensions are per IPC-7351A.

⁽²⁾ The date code printing applies to all resistor sizes except for 0603.

Table 4—Performances

Test or Conditions	ΔR Limits of FRSM Series	
	Typical	Performance Limits ⁽¹⁾
Thermal Shock, 100 x (-65°C to +150°C), see Figure 6	±0.005% (50 ppm)	±0.01% (100 ppm)
Low Temperature Operation, -65°C, 45 min at P _{nom}	±0.0025% (25 ppm)	±0.005% (50 ppm)
Short Time Overload, 6.25 x Rated Power, 5 s	±0.005% (50 ppm)	±0.01% (100 ppm)
High Temperature Exposure, +150°C, 100 h	±0.0025% (25 ppm)	±0.005% (50 ppm)
Resistance to Soldering Heat, +245°C for 5 s, +235°C for 30 s	±0.005% (50 ppm)	±0.01% (100 ppm)
Moisture Resistance	±0.003% (30 ppm)	±0.01% (100 ppm)
Load Life Stability, +70°C for 2000 h at Rated Power, see Figure 8	±0.0025% (25 ppm)	±0.005% (50ppm)
Load Life Stability, +70°C for 10,000 h at Rated Power	±0.005% (50 ppm)	±0.04% (400ppm)

⁽¹⁾ As shown +0.01 Ω to allow for measurement errors at low values.

PULSE TEST

Test Description and Results

All parts baked at +125°C for 1 hr and allowed to cool at room temperature for 1 hr, prior to testing. By using an electrolytic 0.01 μF capacitor charged to 1000 VDC, a single pulse was performed on 20 units of 1206, for each value: 100Ω, 1 KΩ and 10 KΩ of surface mount Bulk Metal® Foil resistor and thin film resistor. The unit was allowed time to cool down, after which the resistance measurement was taken and displayed in ppm deviation from the initial reading.

Figure 5—Pulse Test Description

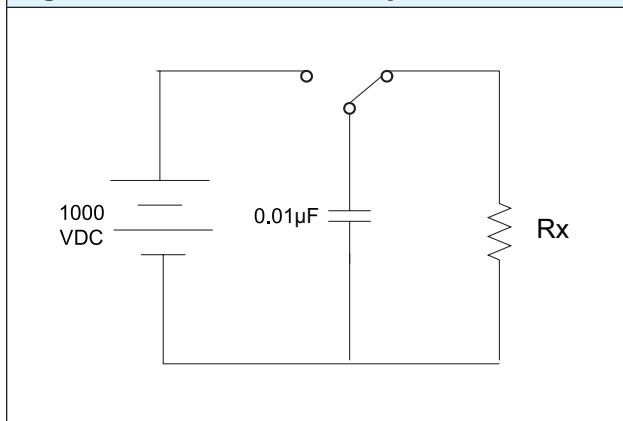
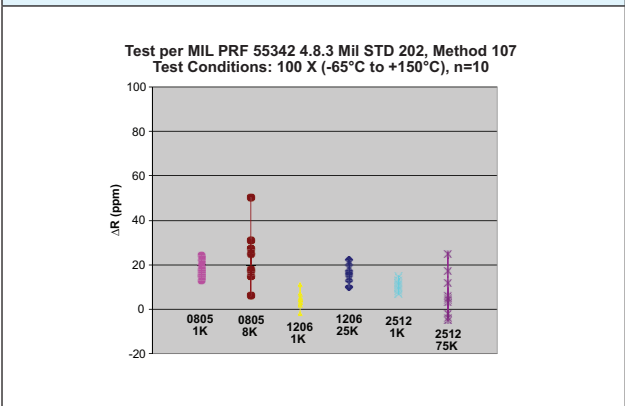

Table 5—Pulse Test Results

Value	Voltage	T = RC	AVERAGE DEVIATION (%)	
			Bulk Metal Foil	Thin Film
100R	1000 VDC	1 μsec	<0.001	Open
1k		10 μsec		>35
10k		100 μsec		>0.008

Figure 6—Thermal Shock Test



ELECTROSTATIC DISCHARGE (ESD)

ESD can be categorized into three types of damages:

Parametric Failure occurs when the ESD event alters one or more device parameters (resistance in the case of resistors), causing it to shift from its required tolerance. This failure does not directly pertain to functionality; thus a parametric failure may be present while the device is still functional.

Catastrophic Damage occurs when the ESD event causes the device to immediately stop functioning. This may occur after one or a number of ESD events with diverse causes, such as human body discharge or the mere presence of an electrostatic field.

Latent Damage occurs when the ESD event causes moderate damage to the device, which is not noticeable, as the device appears to be functioning correctly. However, the load life of the device has been dramatically reduced, and further degradation caused by operating stresses may cause the device to fail during service. Latent damage is the source for greatest concern, because it is very difficult to detect by re-measurement or by visual inspection, since damage may have occurred under the external coating.

Test Description and Results

By using a electrolytic 500 pF capacitor charged up to 4500 V, pulses were performed on 10 units of 1206, 10 kΩ of three different Surface Mount Chip Resistors technologies, with an initial voltage spike of 2500 V (Figure 7). The unit was allowed time to cool down, after which the resistance measurement was taken and displayed in ppm deviation from the initial reading. Readings were then taken in 500 V increments up to 4500 V.

Figure 7 – ESD Test Description

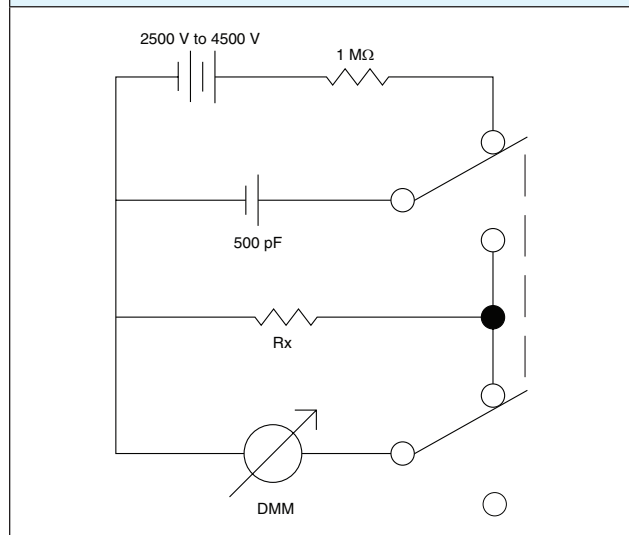

POWER COEFFICIENT OF RESISTANCE (PCR)

In precision resistors with low TCR, the self heating (Joule effect) causes the resistor not to perform strictly to its TCR specifications. This inaccuracy will result in an error at the end in the resistance value under applied power. Vishay Foil Resistors introduced a new concept of Power Coefficient of Resistance (PCR) along with a new Z-Foil technology which leads to reduction of the sensitivity of precision resistor to ambient temperature variations and changes of applied power.

Figure 9 represents PCR behavior of three different resistor technologies under applied power.

Figure 9 – Behavior of Three Different Resistor Technologies Under Applied Power (Power Coefficient Test)

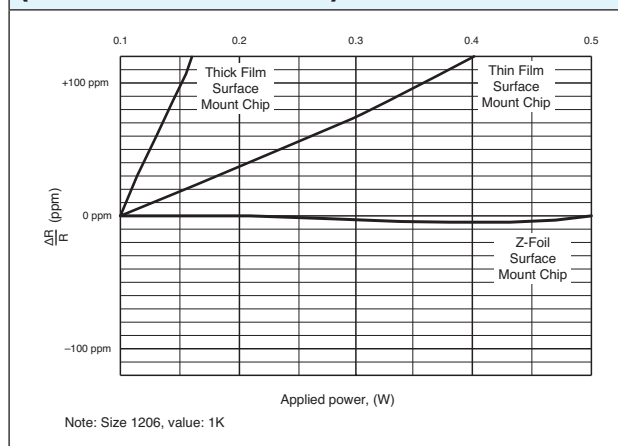

Table 6 – ESD Test Results

Volts	ΔR (%)		
	Thick Film	Thin Film	Bulk Metal Foil
2500	-2.7	97	<0.005
3000	-4.2	366	
3500	-6.2	>5000	
4000	-7.4	>5000	
4500	-8.6	Open	

Figure 8 – Load Life Test for 2000 Hrs @ +70°C at Rated Power

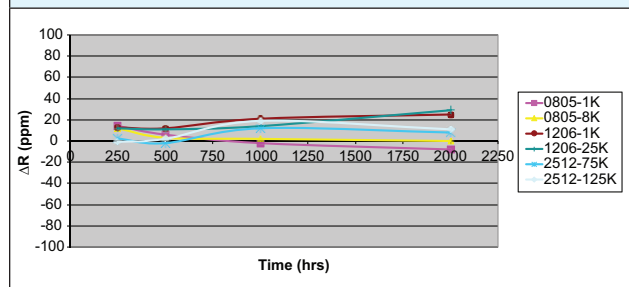

Figure 10 – Current Path in a Resistive Alloy

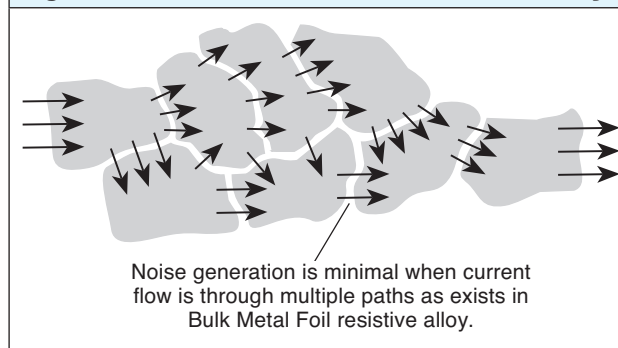
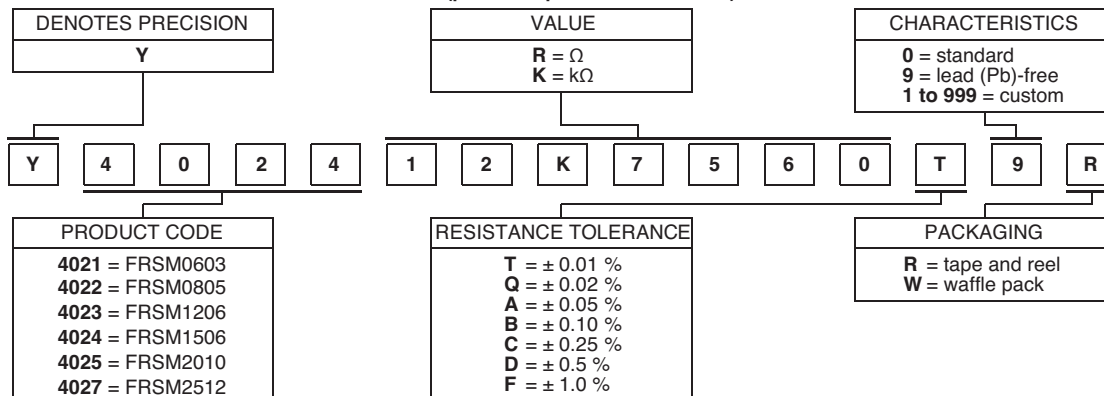

Table 7 – Part Number Information ⁽¹⁾

NEW GLOBAL PART NUMBER: Y402412K7560T9R (preferred part number format)



FOR EXAMPLE: ABOVE GLOBAL ORDER Y4024 12K7560 T 9 R:

TYPE: FRSM1506
 VALUES: 12.7560 kΩ
 ABSOLUTE TOLERANCE: 0.01 %
 TERMINATION: lead (Pb)-free
 PACKAGING: tape and reel

HISTORICAL PART NUMBER: FRSM1506 12K756 TCR0.2 T S T (will continue to be used)

FRSM1506	12K756	TCR0.2	T	S	T
MODEL	RESISTANCE VALUE	TCR CHARACTERISTICS	TOLERANCE	TERMINATION	PACKAGING
FRSM0603 FRSM0805 FRSM1206 FRSM1506 FRSM2010 FRSM2512	12.756 kΩ		T = ± 0.01 % Q = ± 0.02 % A = ± 0.05 % B = ± 0.10 % C = ± 0.25 % D = ± 0.5 % F = ± 1.0 %	S = lead (Pb)-free B = tin/lead	T = tape and reel W = waffle pack

Note

⁽¹⁾ For non-standard requests, please contact application engineering.

Disclaimer

ALL PRODUCTS, PRODUCT SPECIFICATIONS AND DATA ARE SUBJECT TO CHANGE WITHOUT NOTICE.

Vishay Precision Group, Inc., its affiliates, agents, and employees, and all persons acting on its or their behalf (collectively, "VPG"), disclaim any and all liability for any errors, inaccuracies or incompleteness contained herein or in any other disclosure relating to any product.

The product specifications do not expand or otherwise modify VPG's terms and conditions of purchase, including but not limited to, the warranty expressed therein.

VPG makes no warranty, representation or guarantee other than as set forth in the terms and conditions of purchase. **To the maximum extent permitted by applicable law, VPG disclaims (i) any and all liability arising out of the application or use of any product, (ii) any and all liability, including without limitation special, consequential or incidental damages, and (iii) any and all implied warranties, including warranties of fitness for particular purpose, non-infringement and merchantability.**

Information provided in datasheets and/or specifications may vary from actual results in different applications and performance may vary over time. Statements regarding the suitability of products for certain types of applications are based on VPG's knowledge of typical requirements that are often placed on VPG products. It is the customer's responsibility to validate that a particular product with the properties described in the product specification is suitable for use in a particular application. You should ensure you have the current version of the relevant information by contacting VPG prior to performing installation or use of the product, such as on our website at vpgsensors.com.

No license, express, implied, or otherwise, to any intellectual property rights is granted by this document, or by any conduct of VPG.



The products shown herein are not designed for use in life-saving or life-sustaining applications unless otherwise expressly indicated. Customers using or selling VPG products not expressly indicated for use in such applications do so entirely at their own risk and agree to fully indemnify VPG for any damages arising or resulting from such use or sale. Please contact authorized VPG personnel to obtain written terms and conditions regarding products designed for such applications.

Product names and markings noted herein may be trademarks of their respective owners.





Copyright Vishay Precision Group, Inc., 2014. All rights reserved.

Looking for pricing, stock, or lifecycle information?

Click below to explore more details on WIN SOURCE:

-  [View Y4022100R000Q0R on WIN SOURCE](#)
-  [VPG Foil Resistors Information](#)

Optimize Your Supply Chain with WIN SOURCE Solutions

-  Global Sourcing Solution
-  Obsolete Management
-  Cost Control Management
-  Shortage Management
-  Alternative Solution
-  Excess Inventory Management