



**THE DATASHEET OF  
8Z-19.200MEEQ-T**



### Features

Frequency range : 12MHz to 66MHz  
 Ceramic SMD package  
 Seam sealing  
 External dimensions (mm)  
 L : 2.5 x W : 2.0 x H : 0.55  
 RoHS compliant & Pb free

### Applications

Bluetooth, Wireless LAN  
 Microprocessor  
 Mobile phone, Computer, Modem  
 Audio, Video  
 Consumer products

### Electrical Characteristics

Item		8Z	Conditions
Frequency Range	$F_0$	12MHz ~ 66MHz	
Frequency Tolerance	$F_{tol}$	±30ppm, ±20ppm, ±10ppm	at 25°C
Frequency Stability over Operating Temperature Range (refer to 25°C)	$F_{stab}$	±30 ppm	-20°C ~ +70°C
		±20 ppm	
		±10 ppm	
		±10 ppm	-30°C ~ +85°C
		±30 ppm	-40°C ~ +85°C
		±20 ppm	
±60 ppm	-40°C ~ +125°C		
Operating Temperature Range	$T_{OTR}$	-20°C ~ +70°C	
		-40°C ~ +85°C	
		-40°C ~ +125°C	
Shunt Capacitance	$C_0$	3pF Max.	
Drive Level	$D_L$	1 ~ 200μW (100μW Typ.)	
Load Capacitance	$C_L$	6pF, 8pF, 10pF 12pF, 16pF, 18pF, 20pF	
Aging (at 25°C ± 3°C, first year)	$F_{aging}$	±3ppm Max.	Note [1]
Storage Temperature Range	$T_{STR}$	-55°C ~ +125°C	

#### Notes:

[1] Please contact us for low aging +/-1ppm grade crystals.

### Motional Resistance (ESR)

Fundamental	
12 ~ 13 MHz	150Ω Max.
14 ~ 30 MHz	100Ω Max.
30 ~ 66 MHz	60Ω Max.

## Dimensions

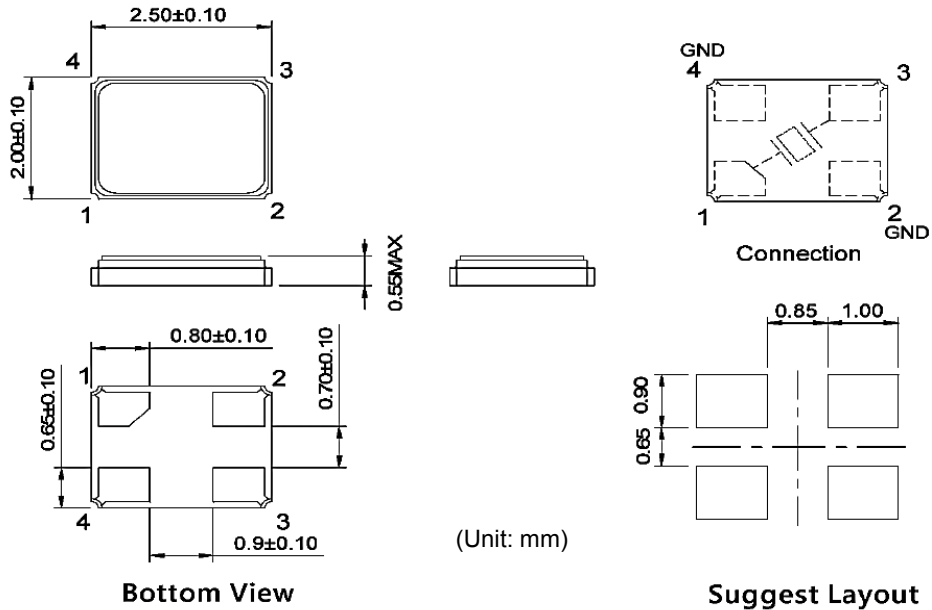

## Ordering Information

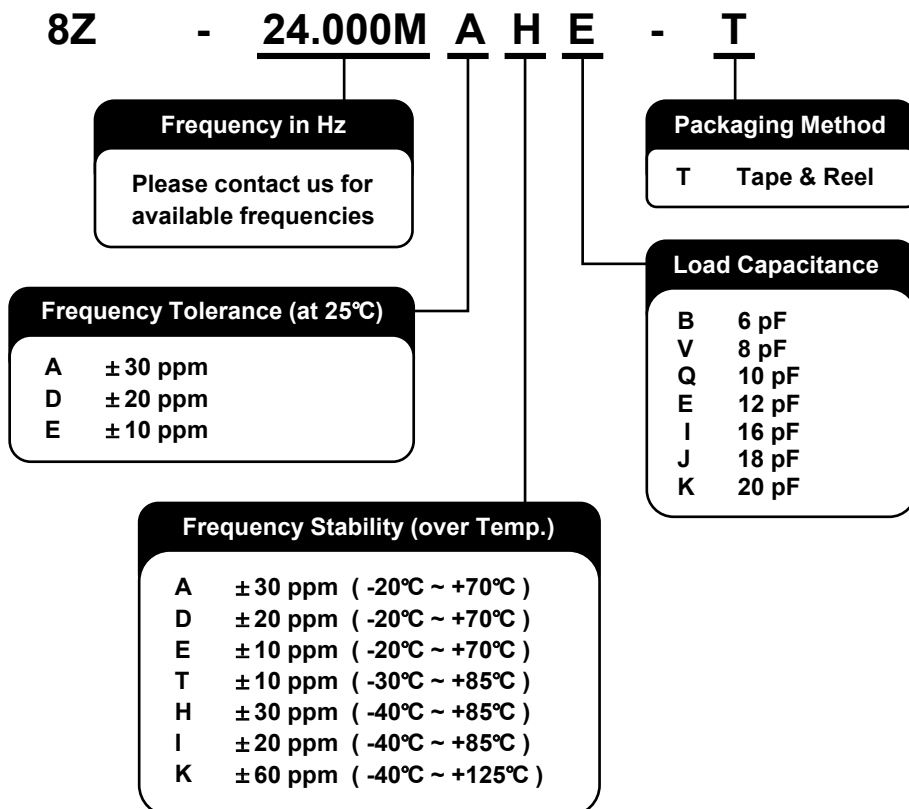

### Packing

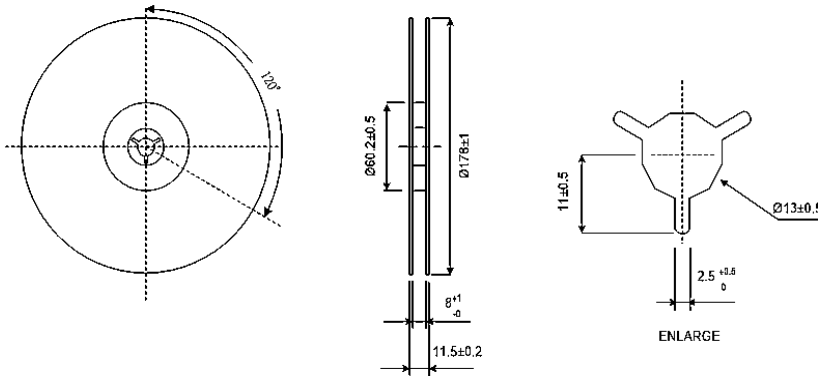
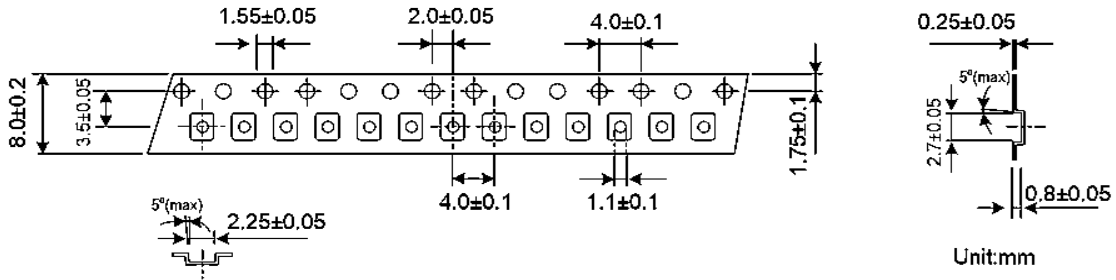

### Reflow Profile

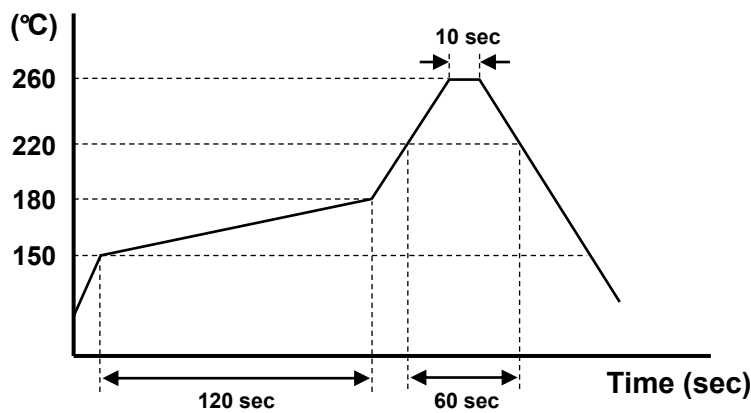

Solder melting point : 220°C ± 10°C, 60 sec. Min.

Peak temperature : 260°C ± 10°C, 10 sec. Min.



## Looking for pricing, stock, or lifecycle information?

Click below to explore more details on WIN SOURCE:

-  [View 8Z-19.200MEEQ-T on WIN SOURCE](#)
-  [TXC CORPORATION](#) Information

## Optimize Your Supply Chain with WIN SOURCE Solutions

-  Global Sourcing Solution
-  Obsolete Management
-  Cost Control Management
-  Shortage Management
-  Alternative Solution
-  Excess Inventory Management