



**THE DATASHEET OF
FL4800049**



FL Series Quartz Crystal Legacy NKS3 Series
3.2 x 2.5mm

Miniature Quartz Crystal Ceramic SMD

FL



3.2 x 2.5mm Ceramic SMD

Product Description

The 4-pad FL series seam seal devices incorporate a sub-miniature AT-cut crystal resonator housed in a standard 3.2 x 2.5mm ceramic package.

These compact crystals are ideal for surface mounting in densely populated or small form-factor PCB applications.

Product Features

- Rugged AT-cut crystal construction
- Miniature 3.2 x 2.5mm ceramic package
- Available on tape & reel; 8mm tape, 3000 units per reel
- Pb-free and RoHS/Green compliant

Typical Applications

- GSM, CDMA, GPRS
- PCMCIA Cards
- Portable / hand-held PCs
- Notebook PC
- HDD
- GPS
- Bluetooth
- Wireless LAN
- UWB
- ZigBee
- Digital Tuner

Package: (Scale: none; dimensions are in mm)

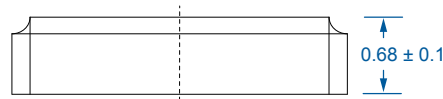
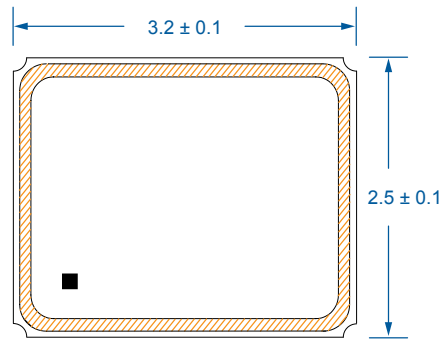

Pin Functions:

Pin	Function
1	Xtal
2	Case
3	Xtal
4	Case

Part Ordering Information:



Following the above format, Saronix-eCera part numbers will be assigned upon confirmation of exact customer requirements.

Miniature Quartz Crystal Ceramic SMD **FL**



A product Line of
Diodes Incorporated



FL Series Quartz Crystal
Legacy NKS3 Series | 3.2 x 2.5mm

Frequency Range:

- 8 MHz to 66.0000 MHz (Fundamental)

Characteristics at 25°C ±2°C:

- Frequency Calibration Tolerance: ±10ppm, ±20ppm, or ±30ppm
- Load Capacitance: 8 to 32pF or Series Resonance
- Effective Series Resistance (ESR):
 - 500Ω max (8 to 11.9 MHz)
 - 80Ω max (12 to 19.9 MHz)
 - 60Ω max (20 to 29.9 MHz)
 - 40Ω max (30 to 66 MHz)
- Drive Level: 10μW typ. (100μW max)
- Shunt Capacitance: 5pF Max

Temperature Range:

- Operating: -20 to +70°C or -40 to +85°C or -40 to +125°C
- Storage: -55 to +125°C

Temperature Stability:

- ±10ppm, ±20ppm, ±30ppm, or ±50ppm (-20 to +70°C)
- ±30ppm, or ±50ppm (-40 to +85°C)
- ±50ppm, or ±70ppm (-40 to 125°C)

Aging at 25°C, First Year:

- ±3ppm Max

Reflow Temperature:

- 260°C Max, 10 seconds Max

Mechanical

- Shock: JESD22-B104 Condition B
- Solderability: J-STD-002
- Terminal Strength: MIL-STD-883 Method 2004
- Vibration: JESD22-B103
- Solvent Resistance: JESD22-B107
- Resistance to Soldering Heat: J-STD-020C Table 5-2 Pb-free devices (3 cycles max)

Environmental

- Gross Test Leak: JESD22-A109, Condition C
- Fine Test Leak: JESD22-A109, Condition A1
- Moisture Resistance: JESD22-A113
- Insulation Resistance: 500 MΩ min (100 VDC)

Legacy Ordering Information - For Reference Only:



Part Number Example:

Spec: Freq 18.1234MHz, ±30ppm calib, ±30ppm stab, -20 to +70°C, 16pF, T&R = NKS3NAD1-18.1234-16(T)

Looking for pricing, stock, or lifecycle information?

Click below to explore more details on WIN SOURCE:

 [View FL4800049 on WIN SOURCE](#)

 [Diodes Incorporated](#) Information

Optimize Your Supply Chain with WIN SOURCE Solutions

-  Global Sourcing Solution
-  Obsolete Management
-  Cost Control Management
-  Shortage Management
-  Alternative Solution
-  Excess Inventory Management