

Specification

Drawing No.	TKY1T-H1-22290-00[45]
Issued Date.	September 17, 2022

TO: Digi-Key

Note: In case of specification change, KYOCERA Part Number also will be changed.

Product Name	Crystal Oscillator
Product Model	_____
Frequency	32.768 kHz
Customer Part Number	_____
Customer Specification Number	_____
KYOCERA Part Number	KC2016K32K7680C12A00
Remarks	RoHS Compliant / MSL 1

Customer Acceptance

Accept Signature	Accept Date	
	Department	
	Person in charge	

Seller

KYOCERA Corporation
Corporate Electronic Components Group
Electronic Components Sales Division

6 Takeda Tobadono-cho, Fushimi-ku, Kyoto
612-8501 Japan

TEL. No. 075-604-3500

FAX. No. 075-604-3501

KYOCERA Corporation

Corporate Electronic Components Group
RF Devices Division

Yamagata higashine Plant
5850, Higashine-koh, Higashine-shi, Yamagata
999-3701 Japan

TEL. No. 0237-43-5611

FAX. No. 0237-43-5615

Design Department	Quality Assurance	Approved by	Examined by	Written by
Crystal Components Application Engineering Section2 RF Devices Engineering Department 1 RF Devices Division	Y.Kakuta	T.Koyanagi	K.Jikuhara	Y.Kato

KYOCERA Corporation

KBS-5079J(1/7)

1. Scope

This specification shall be defined of the Clock Oscillator for the integrated circuits (ICs).

2. Customer Part Number

3. KYOCERA Part Number**KC2016K32K7680C12A00****4. Electrical Characteristics****4-1. Absolute Maximum Rating**

Item	Symbol	Rated Value	Units
Power Supply Voltage	V_{CC}	-0.3 to +4.5	V
Input Voltage	V_{IN}	-0.3 to $V_{CC} + 0.3$	V
Storage Temperature	T_{STG}	-55 to +125	°C

Note:

If the part is used beyond absolute maximum ratings, it may cause internal destruction. The part should be used under the recommended operating conditions the reliability of this part may be damaged if those conditions are exceeded.

4-2. Recommended Operating Conditions

Item	Symbol	Min	Typ	Max	Units	Remarks
Power Supply Voltage	V_{CC}	1.6	3.3	3.63	V	
Input Voltage	V_{IN}	0	---	V_{CC}	V	
Operating Temperature	T_{OPR}	-40	+25	+85	°C	

4-3. Electrical Characteristics

Item	Symbol	Min	Typ	Max	Units	Remarks	
Output Frequency	F_o	---	32.768	---	kHz		
Frequency Tolerance	F_{tol}	-25	---	+25	ppm	Include initial tolerance(@+25°C) and operating temperature range and Rated Power supply voltage change ($V_{CC} \pm 10\%$)	
Aging	F_{Aging}	-3	---	+3			1year@+25°C
Other	F_{Oth}	-4	---	+4			Load change, shock and vibration
Current Consumption (No Load/ $1.6 \leq V_{CC} \leq 2.0V$)	I_{CC}	---	---	28	μA		
Current Consumption (No Load/ $2.0 < V_{CC} \leq 2.8V$)		---	---	29			
Current Consumption (NoLoad/ $2.8 < V_{CC} \leq 3.63V$)		---	---	30			
Standby Current	I_{ST}	---	---	5	μA		
Symmetry (Duty Ratio)	SYM	45	50	55	%	@ 50% V_{CC}	
Rise Time/ Fall Time (10% V_{CC} to 90% V_{CC})	T_r / T_f	---	---	50	ns		
Output Voltage-"L"	V_{OL}	---	---	10% V_{CC}	V	$I_{OL} = 1mA$	
Output Voltage-"H"	V_{OH}	90% V_{CC}	---	---		$I_{OH} = -1mA$	
Output Load	CL	---	---	15	pF	CMOS	
Input Voltage-"L"	V_{IL}	---	---	30% V_{CC}	V		
Input Voltage-"H"	V_{IH}	70% V_{CC}	---	---			
Output Disable Time	t_{dis}	---	---	100	ns		
Output Enable Time	t_{ena}	---	---	2	ms		
Start-up Time	t_{sta}	---	---	5	ms	@Minimum operating voltage to be 0sec	

Note: All electrical characteristics have defined on the maximum loaded and recommended operating conditions.

Table 1

4-4. Measurement Condition

The reference temperature shall be $+25\pm 2^{\circ}\text{C}$. The measurement shall be performed at the temperature range of $+5^{\circ}\text{C}$ to $+35^{\circ}\text{C}$ unless otherwise the result is doubtful.

4-5. Clock Timing Chart

The clock timing chart is "Fig. 2".

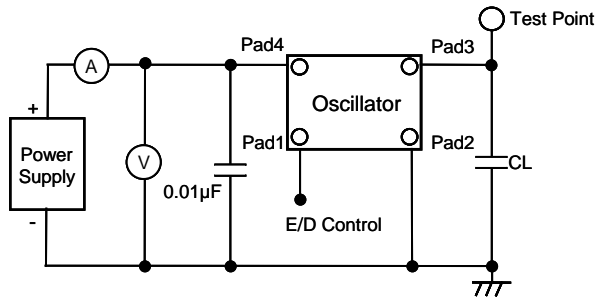

Note: CL includes probe and test fixture capacitance

Fig.1 Test Circuits

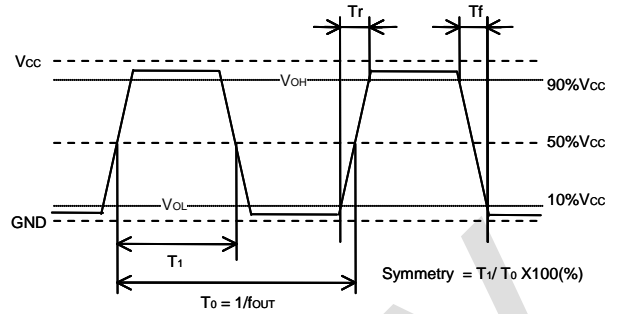
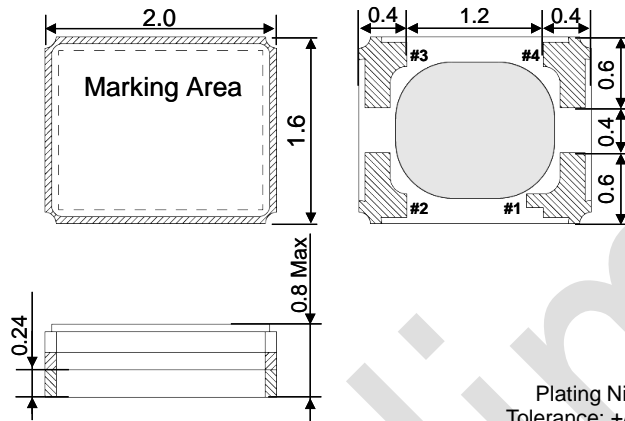

Fig.2 Clock Timing Chart (C-MOS Output)

5. Dimensions and Marking



Plating Ni+Au
Tolerance: +/-0.2
Unit:(mm)

Pad arrangement	
1	Stand-by Function
2	Case GND
3	Output
4	Vcc

Stand-by Function	
Pad1	Pad3 (Output)
OPEN	Active
"H" Level	Active
"L" Level	High Z (No-Oscillation)

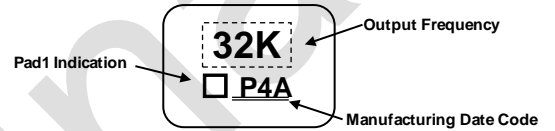

Output Frequency

The output frequency 32.768kHz is indicated "32K."

Manufacturing Date Code

Year	Code	Year	Code	Month	Code	Day	Code	Day	Code	Day	Code
2020	W	2031	L	1	1	1	1	11	B	21	M
2021	A	2032	M	2	2	2	2	12	C	22	N
2022	B	2033	N	3	3	3	3	13	D	23	P
2023	C	2034	P	4	4	4	4	14	E	24	Q
2024	D	2035	Q	5	5	5	5	15	F	25	R
2025	E	2036	R	6	6	6	6	16	G	26	S
2026	F	2037	S	7	7	7	7	17	H	27	T
2027	G	2038	T	8	8	8	8	18	J	28	V
2028	H	2039	V	9	9	9	9	19	K	29	W
2029	J	2040	W	10	A	10	A	20	L	30	X
2030	K	2041	A	11	B	11	B			31	Y
				12	C						

It repeats from A in 2041 and after wards.

e.g. : "P4A" means "Apr-10-2034"

Table 2

6. Parts Numbering Guide

KC2016K32K7680 C 1 2 A 00

A B C D E F G

- A. Series (SMD Oscillator)
 B. Output Frequency 32.768KHz
 C. Output
 C: C-MOS
 D. Supply Voltage
 1: 1.8V/ 2.5V/ 3.3V Compatible
 E. Frequency Tolerance
 4-3. Electrical Characteristics reference

- F. Symmetry (Duty Ratio) and Stand-by Function
 A: Symmetry: 45% to 55% with Stand-by Function
 G. Suffix for Individual Requirements
 (STD Specification is "00")
 Packing (Tape & Reel 2,000pcs/Reel)

7. Environmental Characteristics

Items	Conditions	Criteria of Acceptance
7-1. Solderability	Soaking: +245±5°C, 5.0±0.5sec	Dipped potion: Minimum 95% coverage
7-2. Soldering Heat Resistance	Reflow soldering: Peak +260°C max, 10sec, Twice max	Without looseness or crack etc.
7-3. Temperature Cycle	10cycles: -55°C to +125°C (30minuts each/ cycle)	Clause 7-10 shall be satisfied.
7-4. Mechanical Shock (Pulse)	5 times 14,750m/sec ² (1,500G), Duration of pulse 0.5msec (MIL-STD-883D-2002.3 Condition B)	
7-5. Vibration	4 times each axis X, Y, Z: 20 to 2,000Hz and 2,000Hz to 20Hz/cycle Peak acceleration 196m/sec ² (20G) (MIL-STD-883D-2007.2 Condition A)	
7-6. High Temperature	1000 hours: Temperature: +85+5/-3°C	
7-7. Low Temperature	1000 hours: Temperature: -40+5/-3°C	
7-8. Humidity Cycle	10 cycles: Based on 1004 specifications (MIL-STD-883D-1004.7)	Clause 7-1 shall be satisfied.
7-9. Hermeticity 1 (Gross leak)	Soaking: +125°C, 5minutes	No bubbles appeared
7-10. Hermeticity 2 (Fine leak)	Measured by Helium Detector Equipment (MIL-STD-883D-1014.10 Condition A1)	5x10 ⁻⁹ Pa m ³ /sec max

After each testing, the parts shall be subjected to standard atmospheric conditions more than 2 hours. After that, the electrical characteristics shall be measured. The result of the test shall be satisfied **Table 1**.

Table 3

8. Recommended Land pattern and Soldering Guide

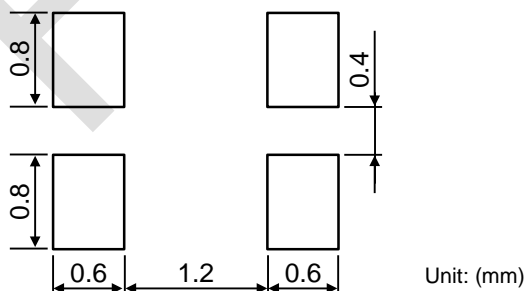

Note:

Since the part doesn't have Bypass Capacitor between V_{cc} and GND, Please mount high frequency type capacitor 0.01μF to the nearest position of oscillator.

Fig.3 Land pattern

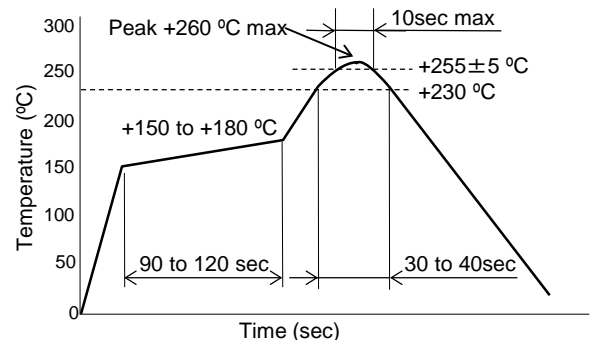

- Available Reflow times: Maximum twice

Fig.4 Reflow profile (Lead Free Available)

9. Taping Specifications

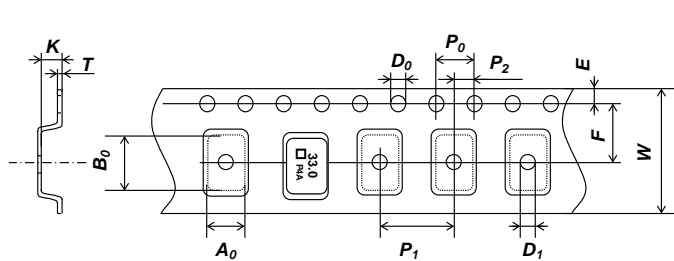

Unit: (mm)

Symbol	A₀	B₀	W	F	E
Dimensions	1.8±0.05	2.25±0.05	8.0±0.2	3.5±0.05	1.75±0.1
Symbol	P₁	P₂	P₀	D₀	T
Dimensions	4.0±0.1	2.0±0.05	4.0±0.1	1.5±0.1/-0	0.2±0.05
Symbol	K	D₁			
Dimensions	0.9±0.1	1.1±0.1			

Fig.5 Emboss Carrier Tape

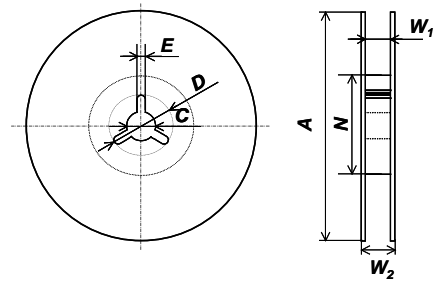

Unit: (mm)

Symbol	A	N	W₁
Dimensions	180 +0/-1.5	60+1/-0	9.0+0.3/-0
Symbol	W₂	C	D
Dimensions	11.4±1.0	13.0±0.2	21.0±0.8
Symbol	E		
Dimensions	2.0±0.5		

Fig.6 Reel

9-1. Taping Quantities

- The taping of per reel shall be packed 2,000 pcs.
- The parts shall be contained continuously in the pocket.

9-2. Leader and Blank Pockets

- The package shall be consisted of leader, blank pockets and loaded pocket as follows "Fig. 7".
- The power of peeling strength between top tape and carrier tape shall be 0.1N(10gf) to 1.0N(100gf) as follows "Fig. 8".

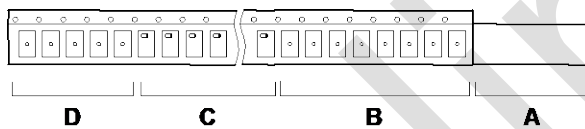

- A) Leader
 B) Blank Pocket (40mm to 320mm)
 A+B: 400mm to 560mm
 C) Load Pocket
 D) Blank Pocket (160mm minimum)

Fig.7 Packing Method

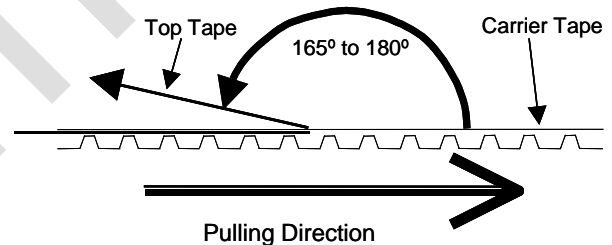

Fig.8 Peeling Strength

9-3. Reel Label

The reel label shall be consisted as below. (Based on EIAJ C-3 format)

- A) Customer Part Number
 B) Lot No.
 C) Quantities
 D) Shipping Date
 E) Vender Name

9-4. Exterior Package Label

The oscillator shall be packed properly to avoid defect in transportation. The exterior package label shall be consisted as below.

- A) Name of Customer
 B) P/O No.
 C) Customer Part Number
 D) Lot No.
 E) Quantities
 F) Shipping Date
 G) Vender Name

10. The agreement of this specifications

In case there is any obscure point or doubt concerning the contents of the specification, it shall be settled through consultation of both parties.

11. Remarks on Usages

A) Storage Conditions

The parts shall be stored in temperature range of -5 to +40°C, humidity 40 to 60% RH, and avoid direct sunlight. Then the parts shall be used within 6 months.

B) Handling Conditions

Although the part has protection circuit against static electricity, when excess static electricity is applied, the inside IC may get damaged.

Before mounting on the PCB, please make sure the direction of the part is correct. Otherwise the part of temperature will increase. And also the part will have some damages.

Please do not use the parts under the unfavorable condition such as beyond specified range in this specification.

Please do not use the parts under the condition, in the water or in the salt water also environment of dew or harmful gas.

Please make sure the condition of pick and place following pick up nozzle guideline.

Picking Method: Case of Head Unit 1.6 x 1.2mm (Inside Diameter)

The proper condition of pick and place will be different each equipment. Therefore, please check before testing.

This product can be used for general electronic equipment (information equipment, communication equipment, audiovisual equipment, measuring equipment, home appliances, etc.) Intended to be used. Equipment and systems (traffic equipment, safety equipment, aviation / space control, nuclear power control, life support equipment) that require special quality and reliability and whose failure or malfunction may endanger human life or harm the human body. (Including medical devices, etc.), basic driving functions (running, turning, stopping) and collision safety in traffic equipment, applications related directly or indirectly to collision safety, and applications that are expected to have a significant impact on property, etc. It is not intended to be used. In the unlikely event that this product is used for any of these purposes, we will not be liable for any damages resulting from such use.

C) Rework Condition

Please do not pick up Head Unit. We can't guaranty electrical performance and reliability.

D) Soldering Conditions

This product can respond to the general Pb-free reflow profile. The wave soldering cannot be supported.

E) Soldering in Mounting

In case of Solder paste and conductive glue contact product lid or product side face exception for product terminal it's possible to influence product characteristics.

Please be careful above contents.

F) Washing Conditions

Ultra sonic cleaning is available. However there is a possibility that Crystal in the part may cause damaged under certain condition. Therefore please test before using.

After washing, please dry the parts completely. Otherwise water drops between the parts and PCB may cause migration.

In case of using this part without above precaution, Kyocera is unable to guarantee the specific characteristics.

12. Quality guarantee

In case when Kyocera Corporation rooted failure occurred within 1year after its delivery, substitute product will be arranged based on discussion. Quality guarantee of product after 1year of its delivery is waived.

Looking for pricing, stock, or lifecycle information?

Click below to explore more details on WIN SOURCE:

- ⊖ [View KC2016K32K7680C12A00 on WIN SOURCE](#)
- ⊖ [AVX Corp/Kyocera Corp Information](#)

Optimize Your Supply Chain with WIN SOURCE Solutions

- ✓ Global Sourcing Solution
- ✓ Obsolete Management
- ✓ Cost Control Management
- ✓ Shortage Management
- ✓ Alternative Solution
- ✓ Excess Inventory Management