

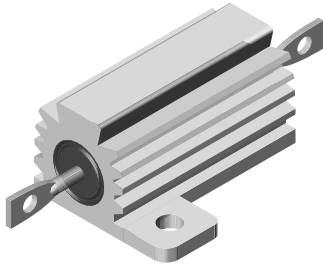

**THE DATASHEET OF
RH05010R00FC02**



Wirewound Resistors, Industrial Power, Aluminum Housed, Chassis Mount

LINKS TO ADDITIONAL RESOURCES

FEATURES

- Molded construction for total environmental protection
- Complete welded construction
- Meets applicable requirements of MIL-PRF-18546
- Available in non-inductive styles (type NH) with Ayrton-Perry winding for lowest reactive components
- Mounts on chassis to utilize heat-sink effect
- Excellent stability in operation (< 1 % change in resistance)
- MIL-PRF-18546 qualified, type RE resistors can be found at: www.vishay.com/doc?30282
- Material categorization: for definitions of compliance please see www.vishay.com/doc?99912

RoHS*
Available

HALOGEN FREE
Available

GREEN
(5-2008)
Available

Note

* This datasheet provides information about parts that are RoHS-compliant and /or parts that are non-RoHS-compliant. For example, parts with lead (Pb) terminations are not RoHS-compliant. Please see the information / tables in this datasheet for details

STANDARD ELECTRICAL SPECIFICATIONS							
GLOBAL MODEL	HISTORICAL MODEL	POWER RATING $P_{25^{\circ}\text{C}}$ W	RESISTANCE RANGE Ω $\pm 0.05\%$, $\pm 0.1\%$	RESISTANCE RANGE Ω $\pm 0.25\%$	RESISTANCE RANGE Ω $\pm 0.5\%$	RESISTANCE RANGE Ω $\pm 1\%$, $\pm 3\%$, $\pm 5\%$	WEIGHT (typical) g
RH005	RH-5	7.5	0.5 to 6.75K	0.1 to 8.6K	0.05 to 8.6K	0.02 to 24.5K	3
NH005	NH-5	7.5	0.5 to 2.32K	0.1 to 3.27K	0.05 to 3.27K	0.05 to 12.75K	3
RH010	RH-10	12.5	0.5 to 12.7K	0.1 to 16.69K	0.05 to 16.69K	0.01 to 47.1K	5
NH010	NH-10	12.5	0.5 to 4.45K	0.1 to 5.54K	0.05 to 5.54K	0.05 to 23.5K	5
RH025	RH-25	25	0.5 to 25.7K	0.1 to 32.99K	0.05 to 32.99K	0.01 to 95.2K	12
NH025	NH-25	25	0.5 to 9.09K	0.1 to 12.8K	0.05 to 12.8K	0.05 to 47.6K	12
RH050	RH-50	50	0.5 to 73.4K	0.1 to 96K	0.05 to 96K	0.01 to 273K	28
NH050	NH-50	50	0.5 to 26K	0.1 to 36.7K	0.05 to 36.7K	0.05 to 136K	28
RH100	RH-100	100	0.5 to 90K	0.1 to 90K	0.05 to 90K	0.05 to 90K	353
NH100	NH-100	100	0.5 to 37.5K	0.1 to 37.5K	0.05 to 37.5K	0.05 to 37.5K	353
RH250	RH-250	250	0.5 to 116K	0.1 to 116K	0.05 to 116K	0.05 to 116K	637
NH250	NH-250	250	0.5 to 48.5K	0.1 to 48.5K	0.05 to 48.5K	0.05 to 48.5K	637

Note

- RH005 and NH005 printed with 5 W power rating. RH010 and NH010 printed with 10 W power rating. New construction allows these resistors to be rated at higher wattage but will only be printed with the higher wattage upon customer request

TECHNICAL SPECIFICATIONS		
PARAMETER	UNIT	RH RESISTOR CHARACTERISTICS
Temperature Coefficient	ppm/ $^{\circ}\text{C}$	± 20 for 10 Ω and above; ± 50 for 1 Ω to 9.9 Ω , ± 100 for 0.1 Ω to 0.99 Ω
Maximum Working Voltage	V	$(P \times R)^{1/2}$
Insulation Resistance	Ω	10 000 M Ω minimum dry, 1000 M Ω minimum after moisture test
Solderability	-	Meets requirements of ANSI J-STD-002
Operating Temperature Range	$^{\circ}\text{C}$	-55 to +250

GLOBAL PART NUMBER INFORMATION				
Global Part Numbering Example: RH0054R125FC02				
R	H	0	0	5
4	R	1	2	5
F	C	0	2	
GLOBAL MODEL	RESISTANCE VALUE	TOLERANCE CODE	PACKAGING	SPECIAL
RH005 (see Standard Electrical Specifications Global Model column for options)	R = decimal K = thousand 15R00 = 15 Ω 10K00 = 10 k Ω	A = 0.05 % B = 0.1 % C = 0.25 % D = 0.5 % F = 1.0 % H = 3.0 % J = 5.0 %	E02 = lead (Pb)-free, card pack (RH005 - RH050) E01 = lead (Pb)-free, skin pack (RH100 and RH250) C02 = tin / lead, card pack (RH005 - RH050) J01 = tin / lead, skin pack (RH100 and RH250)	(dash number) (up to 3 digits) from 1 to 999 as applicable
Historical Part Numbering Example: RH-5 4.125 Ω 1 % C02				
RH-5	4.125 Ω	1 %	C02	
HISTORICAL MODEL	RESISTANCE VALUE	TOLERANCE CODE	PACKAGING	

DIMENSIONS in inches [millimeters]

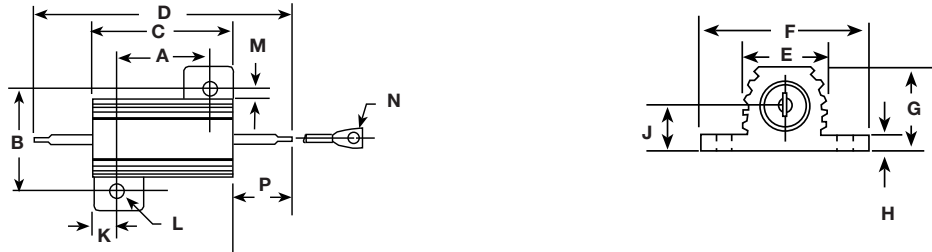
 RH005, 010, 025, 050
 NH005, 010, 025, 050

GLOBAL MODEL	DIMENSIONS in inches [millimeters]													
	A	B	C	D	E	F	G	H	J	K	L	M	N	P
RH005 NH005	0.444 ± 0.005 [11.28 ± 0.127]	0.490 ± 0.005 [12.45 ± 0.127]	0.600 ± 0.030 [15.24 ± 0.787]	1.125 ± 0.062 [28.58 ± 1.57]	0.334 ± 0.015 [8.48 ± 0.381]	0.646 ± 0.015 [16.41 ± 0.381]	0.320 ± 0.015 [8.13 ± 0.381]	0.065 ± 0.010 [1.65 ± 0.254]	0.133 ± 0.010 [3.38 ± 0.254]	0.078 ± 0.010 [1.98 ± 0.254]	0.093 ± 0.005 [2.36 ± 0.127]	0.078 ± 0.015 [1.98 ± 0.381]	0.050 ± 0.005 [1.27 ± 0.127]	0.266 ± 0.062 [6.76 ± 1.57]
RH010 NH010	0.562 ± 0.005 [14.27 ± 0.127]	0.625 ± 0.005 [15.88 ± 0.127]	0.750 ± 0.031 [19.05 ± 0.787]	1.375 ± 0.062 [34.93 ± 1.57]	0.420 ± 0.015 [10.67 ± 0.381]	0.800 ± 0.015 [20.32 ± 0.381]	0.390 ± 0.015 [9.91 ± 0.381]	0.075 ± 0.010 [1.91 ± 0.254]	0.165 ± 0.010 [4.19 ± 0.254]	0.093 ± 0.010 [2.36 ± 0.254]	0.094 ± 0.005 [2.39 ± 0.127]	0.102 ± 0.015 [2.59 ± 0.381]	0.085 ± 0.005 [2.16 ± 0.127]	0.312 ± 0.062 [7.92 ± 1.57]
RH025 NH025	0.719 ± 0.005 [18.26 ± 0.127]	0.781 ± 0.005 [19.84 ± 0.127]	1.062 ± 0.031 [26.97 ± 0.787]	1.938 ± 0.062 [49.23 ± 1.57]	0.550 ± 0.015 [13.97 ± 0.381]	1.080 ± 0.015 [27.43 ± 0.381]	0.546 ± 0.015 [13.87 ± 0.381]	0.075 ± 0.010 [1.91 ± 0.254]	0.231 ± 0.010 [5.87 ± 0.254]	0.172 ± 0.010 [4.37 ± 0.254]	0.125 ± 0.005 [3.18 ± 0.127]	0.115 ± 0.015 [2.92 ± 0.381]	0.085 ± 0.005 [2.16 ± 0.127]	0.438 ± 0.062 [11.13 ± 1.57]
RH050 NH050	1.562 ± 0.005 [39.67 ± 0.127]	0.844 ± 0.005 [21.44 ± 0.127]	1.968 ± 0.031 [49.99 ± 0.787]	2.781 ± 0.062 [70.64 ± 1.57]	0.630 ± 0.015 [16.00 ± 0.381]	1.140 ± 0.015 [28.96 ± 0.381]	0.610 ± 0.015 [15.49 ± 0.381]	0.088 ± 0.010 [2.24 ± 0.254]	0.260 ± 0.010 [6.60 ± 0.254]	0.196 ± 0.010 [4.98 ± 0.254]	0.125 ± 0.005 [3.18 ± 0.127]	0.107 ± 0.015 [2.72 ± 0.381]	0.085 ± 0.005 [2.16 ± 0.127]	0.438 ± 0.062 [11.13 ± 1.57]

DIMENSIONS in inches [millimeters]

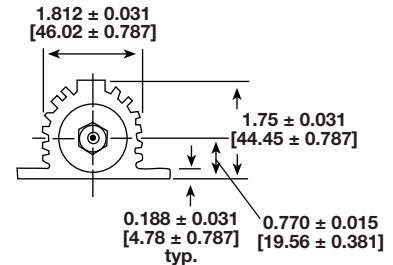
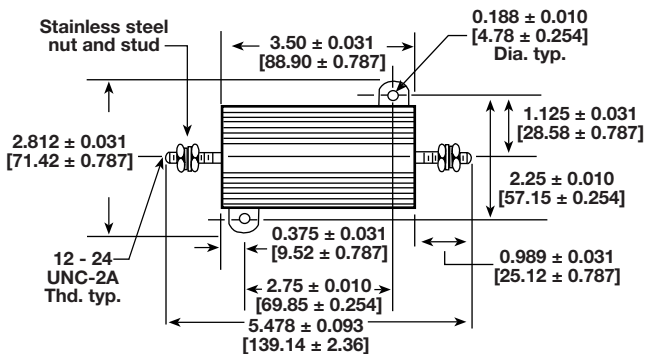
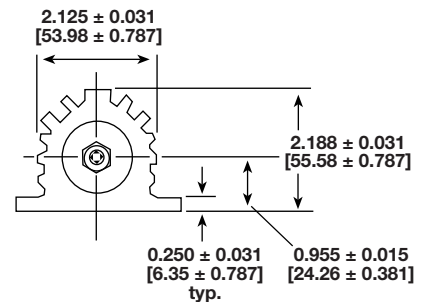
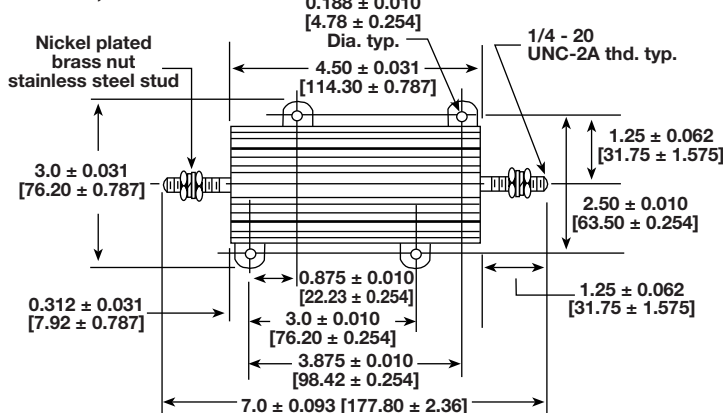
RH100, NH100

RH250, NH250



POWER RATING

Vishay RH resistor wattage ratings are based on mounting to the following heat sink:

- RH005 and RH010: 4" x 6" x 2" x 0.040" thick aluminum chassis (129 sq. in. surface area)
- RH025: 5" x 7" x 2" x 0.040" thick aluminum chassis (167 sq. in. surface area)
- RH050: 12" x 12" x 0.059" thick aluminum panel (291 sq. in. surface area)
- RH100 and RH250: 12" x 12" x 0.125" thick aluminum panel (294 sq. in. surface area)

FREE AIR POWER RATING						
GLOBAL MODEL	RH005 NH005	RH010 NH010	RH025 NH025	RH050 NH050	RH100 NH100	RH250 NH250
W at 25 °C	4.5	7.5	12.5	20	40	100

AMBIENT TEMPERATURE DERATING

Derating is required for ambient temperatures above 25 °C, see the following graph.

Curves **A**, **B**, **C** apply to operation of unmounted resistors. Curve **D** applies to all types when mounted to specified heat sink.

- A** = RH005 and RH010 size resistor, unmounted
- B** = RH025 size resistor, unmounted
- C** = RH050, RH100 and RH250 size resistor, unmounted
- D** = All types mounted to recommended aluminum heat sink

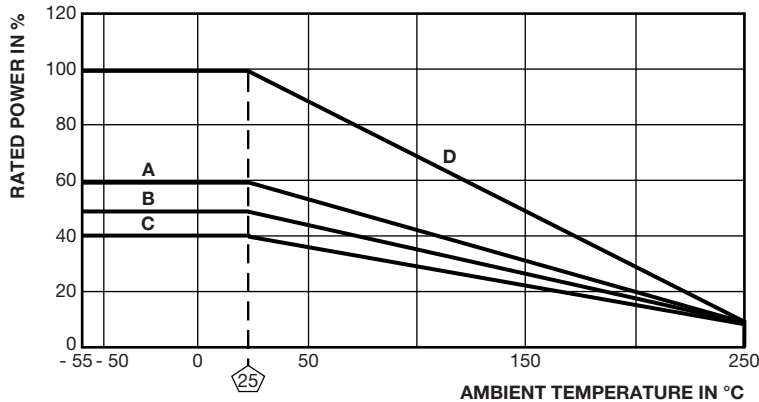

REDUCED HEAT SINK DERATING

Derating is also required when recommended heat sink area is reduced.

- A** = RH005 and RH010 size resistor
- B** = RH025 size resistor
- C** = RH050, RH100 and RH250 size resistor

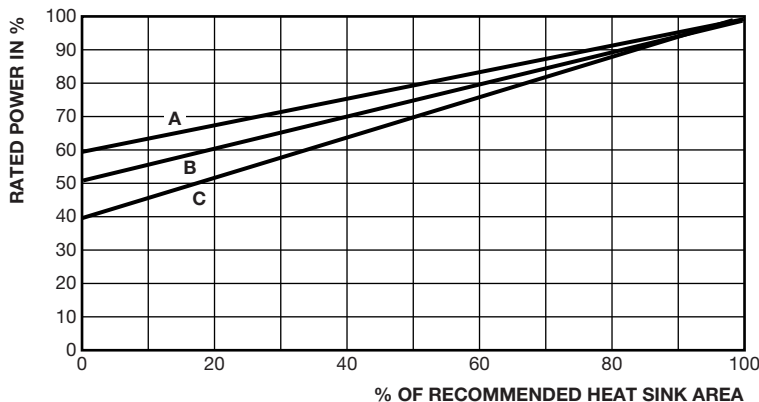



MATERIAL SPECIFICATIONS

Element: copper-nickel alloy or nickel-chrome alloy, depending on resistance value

Core: ceramic, steatite or alumina, depending on physical size

Encapsulant: silicone molded construction

Housing: aluminum with hard anodic coating

End Caps: stainless steel

Standard Terminals: For RH005 through RH050 size terminal finish - tin / lead is 60/40 Sn/Pb w/Nickel underplate and lead (Pb)-free is Ni/Pd/Au, finish is on copper clad steel core terminal. For RH100 and RH250 terminals are threaded stainless steel.

Part Marking: Dale, model, wattage, value, tolerance, date code

NH NON-INDUCTIVE

Models of equivalent physical and electrical specifications are available with non-inductive (Ayrton-Perry) winding. They are identified by substituting the letter N for R in the model number (NH005, for example).

SPECIAL MODIFICATIONS

A number of special modifications to the aluminum housed resistor style are available upon request. Special modifications include:

- Terminal configurations and materials
- Resistance values and tolerances
- Low resistance temperature coefficient (RTC)
- Housing configuration
- Threaded mounting holes
- Preconditioning and other additional testing

APPLICABLE MIL SPECIFICATIONS

Vishay RH and NH resistors are listed as qualified on the MIL-PRF-18546 QPL. MIL-PRF-18546 qualified, type RE resistors can be found at: www.vishay.com/doc?30282

PERFORMANCE		
TEST	CONDITIONS OF TEST	TEST LIMITS
Thermal Shock	Rated power applied until thermally stable, then a minimum of 15 min at -55 °C	± (0.5 % + 0.05 Ω) ΔR
Short Time Overload	5x rated power for 5 s	± (0.5 % + 0.05 Ω) ΔR
Dielectric Withstanding Voltage	1000 V _{RMS} for RH005, RH010 and RH025; 2000 V _{RMS} for RH050; 4500 V _{RMS} for RH100 and RH250; duration 1 min	± (0.2 % + 0.05 Ω) ΔR
Temperature	250 °C for 2 h	± (0.5 % + 0.05 Ω) ΔR
Moisture Resistance	MIL-STD-202 Method 106, 7b not applicable	± (1.0 % + 0.05 Ω) ΔR
Shock, Specified Pulse	MIL-STD-202 Method 213, 100 g's for 6 ms, 10 shocks	± (0.2 % + 0.05 Ω) ΔR
Vibration, High Frequency	Frequency varied 10 Hz to 2000 Hz, 20 g peak, 2 directions 6 h each	± (0.2 % + 0.05 Ω) ΔR
Load Life	1000 h at rated power, +25 °C, 1.5 h "ON", 0.5 h "OFF"	± (1.0 % + 0.05 Ω) ΔR
Terminal Strength	30 s, 5 pound pull test for RH005 and RH010, 10 pound pull test for other sizes; torque test - 24 pound inch for RH100 and 32 pound inch for RH250	± (0.2 % + 0.05 Ω) ΔR



Disclaimer

ALL PRODUCT, PRODUCT SPECIFICATIONS AND DATA ARE SUBJECT TO CHANGE WITHOUT NOTICE TO IMPROVE RELIABILITY, FUNCTION OR DESIGN OR OTHERWISE.

Vishay Intertechnology, Inc., its affiliates, agents, and employees, and all persons acting on its or their behalf (collectively, "Vishay"), disclaim any and all liability for any errors, inaccuracies or incompleteness contained in any datasheet or in any other disclosure relating to any product.

Vishay makes no warranty, representation or guarantee regarding the suitability of the products for any particular purpose or the continuing production of any product. To the maximum extent permitted by applicable law, Vishay disclaims (i) any and all liability arising out of the application or use of any product, (ii) any and all liability, including without limitation special, consequential or incidental damages, and (iii) any and all implied warranties, including warranties of fitness for particular purpose, non-infringement and merchantability.

Statements regarding the suitability of products for certain types of applications are based on Vishay's knowledge of typical requirements that are often placed on Vishay products in generic applications. Such statements are not binding statements about the suitability of products for a particular application. It is the customer's responsibility to validate that a particular product with the properties described in the product specification is suitable for use in a particular application. Parameters provided in datasheets and / or specifications may vary in different applications and performance may vary over time. All operating parameters, including typical parameters, must be validated for each customer application by the customer's technical experts. Product specifications do not expand or otherwise modify Vishay's terms and conditions of purchase, including but not limited to the warranty expressed therein.

Hyperlinks included in this datasheet may direct users to third-party websites. These links are provided as a convenience and for informational purposes only. Inclusion of these hyperlinks does not constitute an endorsement or an approval by Vishay of any of the products, services or opinions of the corporation, organization or individual associated with the third-party website. Vishay disclaims any and all liability and bears no responsibility for the accuracy, legality or content of the third-party website or for that of subsequent links.

Vishay products are not designed for use in life-saving or life-sustaining applications or any application in which the failure of the Vishay product could result in personal injury or death unless specifically qualified in writing by Vishay. Customers using or selling Vishay products not expressly indicated for use in such applications do so at their own risk. Please contact authorized Vishay personnel to obtain written terms and conditions regarding products designed for such applications.

No license, express or implied, by estoppel or otherwise, to any intellectual property rights is granted by this document or by any conduct of Vishay. Product names and markings noted herein may be trademarks of their respective owners.

Looking for pricing, stock, or lifecycle information?

Click below to explore more details on WIN SOURCE:

 [View RH05010R00FC02 on WIN SOURCE](#)

 [Vishay Information](#)

Optimize Your Supply Chain with WIN SOURCE Solutions

-  Global Sourcing Solution
-  Obsolete Management
-  Cost Control Management
-  Shortage Management
-  Alternative Solution
-  Excess Inventory Management