



**THE DATASHEET OF  
MFR-25FTE52-10K**



# DATA SHEET

## METAL FILM RESISTORS

General Purpose

MFR Series

$\pm 0.5\%$ ,  $\pm 1\%$ ,  $\pm 2\%$ ,  $\pm 5\%$

1/6W to 3W

RoHS compliant & Halogen Free





**APPLICATIONS**

- All general purpose applications
- Power applications

**FEATURES**

- AEC-Q200 qualified
- Wide resistance range
- PPAP ready (MFR-25/MFR50S/MFR-50)
- High stability
- RoHS compliant & halogen-free

**ORDERING INFORMATION**

Part number of the general purpose metal film resistor are identified by the series, power rating, tolerance, packing, temperature coefficient, forming and resistance value.

**PART NUMBER**

**MFR**    **200**    **F**    **T**    **F**    **73-**    **100R**  
 (1)    (2)    (3)    (4)    (5)    (6)    (7)

**(1) SERIES**

MFR Series

**(2) POWER RATING**

|            |            |          |
|------------|------------|----------|
| -12 = 1/6W | -50 = 1/2W | 200 = 2W |
| 25S = 1/4W | 100 = 1W   | 3WS = 3W |
| -25 = 1/4W | 2WS = 2W   | 1WS = 1W |
| 50S = 1/2W |            |          |

**(3) TOLERANCE**

|           |         |         |
|-----------|---------|---------|
| D = ±0.5% | F = ±1% | G = ±2% |
| J = ±5%   |         |         |

**(4) PACKAGING**

|               |              |          |
|---------------|--------------|----------|
| R = Reel Pack | T = Box Pack | B = Bulk |
|---------------|--------------|----------|

**(5) TEMPERATURE COEFFICIENT OF RESISTANCE**

|             |              |                   |
|-------------|--------------|-------------------|
| E=±50ppm/°C | F=±100ppm/°C | - = Based on spec |
|-------------|--------------|-------------------|

**(6) FORMING**

|  |                             |
|--|-----------------------------|
| 26- = 26mm                                   | F = F Type                  |
| 52- = 52.4mm                                 | FK = FK Type                |
| 73- = 73mm                                   | FFK = F-form Kink           |
| M = M-Type Forming                           | FKK = FKK Type              |
| MB = M-form W/fla                            | MT = MT Type Forming        |
| 52A=52.4mm, ψd 0.4±0.02mm                    | FT = FT Type Forming        |
| 52B=52.4mm, ψd 0.45±0.02mm                   | PN = PANAsert               |
| 52C=52.4mm, ψd 0.5±0.02mm                    | AV = AVIsert                |
| 52G=52.4mm, ψd ≥ 0.6mm                       | FB=- FB- Type (for -25&50S) |
| 52H=52.4mm , non-painting on soldering spots |                             |

Note: 26mm, 52.4mm and 73mm represent dimension A of the axial type, please refer to the category of AXIAL/REEL TAPE SPECIFICATION for the detail.

**(7) RESISTANCE VALUE**

E24 & E96 & E192 Series  
 Example:  
 100R = 100Ω, 10K = 10,000Ω, 1M = 1,000,000Ω

**DIMENSIONS**

Unit: mm



|        | Normal | Miniature  | L         | ψD       | H           | ϕd |
|--------|--------|------------|-----------|----------|-------------|----|
| MFR-12 | MFR25S | 3.4 ± 0.3  | 1.9 ± 0.2 | 28 ± 2.0 | 0.45 ± 0.05 |    |
| MFR-25 | MFR50S | 6.3 ± 0.5  | 2.4 ± 0.2 | 28 ± 2.0 | 0.55 ± 0.05 |    |
| MFR-50 | MFR1WS | 9.0 ± 0.5  | 3.3 ± 0.3 | 26 ± 2.0 | 0.55 ± 0.05 |    |
| MFR100 | MFR2WS | 11.5 ± 1.0 | 4.5 ± 0.5 | 35 ± 2.0 | 0.8 ± 0.05  |    |
| MFR200 | MFR3WS | 15.5 ± 1.0 | 5.0 ± 0.5 | 33 ± 2.0 | 0.8 ± 0.05  |    |

**DERATING CURVE**

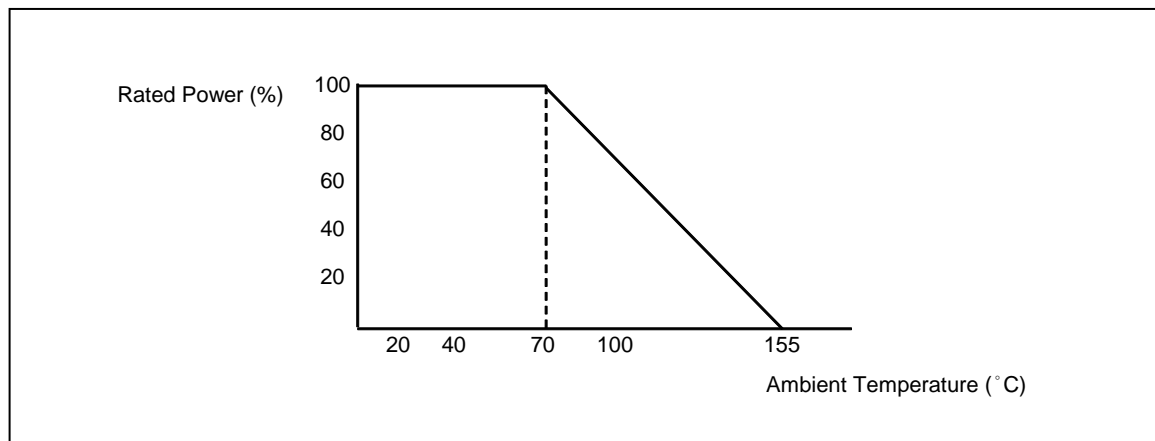

**ELECTRICAL CHARACTERISTICS**

| CHARACTERISTICS             | MFR-12                               | MFR25S | MFR-25 | MFR50S | MFR-50 | MFR1WS | MFR100 | MFR2WS<br>MFR200 | MFR3WS |
|-----------------------------|--------------------------------------|--------|--------|--------|--------|--------|--------|------------------|--------|
| Power Rating at 70 °C       | 1/6W                                 | 1/4W   | 1/4W   | 1/2W   | 1/2W   | 1W     | 1W     | 2W               | 3W     |
| Maximum Working Voltage     | 200V                                 | 200V   | 250V   | 300V   | 350V   | 400V   | 500V   | 500V             | 500V   |
| Maximum Overload Voltage    | 400V                                 | 400V   | 500V   | 600V   | 700V   | 800V   | 1000V  | 1000V            | 1000V  |
| Voltage Proof on Insulation | 300V                                 | 400V   | 500V   | 500V   | 500V   | 700V   | 1000V  | 1000V            | 1000V  |
| Resistance Range            | 1Ω ~ 4M7Ω for E24 & E96 series value |        |        |        |        |        |        |                  |        |
| Operating Temp. Range       | - 55°C to +155°C                     |        |        |        |        |        |        |                  |        |
| Temperature Coefficient     | ±50ppm/°C , ±100ppm/°C               |        |        |        |        |        |        |                  |        |

Note: For resistance value out of above range is by request.

**TEST AND REQUIRMENTS**

| TEST                          | TEST METHOD      | PROCEDURE   | APPRAISE                                  |
|-------------------------------|------------------|---|---|
| Short Time Overload           | IEC 60115-1 4.13 | 2.5 times RCWV for 5 sec.(Not more than maximum overload voltage)             | ±0.25%+0.05Ω                              |
| Voltage Proof on Insulation   | IEC 60115-1 4.7  | In V-Block for 60 sec. test voltage as above table                            | No Breakdown                              |
| Temperature Coefficient       | IEC 60115-1 4.8  | Between -55°C to +155°C   | By Type                                   |
| Insulation Resistance         | IEC 60115-1 4.6  | In V-Block for 60 sec.  | >10,000MΩ                                 |
| Solderability                 | IEC 60115-1 4.17 | 245±5°C for 3±0.5 Sec.  | 95% Min. coverage                         |
| Solvent Resistance of Marking | IEC 60115-1 4.30 | IPA for 5±0.5 Min. with ultrasonic  | No deterioration of coatings and markings |
| Robustness of Terminations    | IEC 60115-1 4.16 | Direct load for 10 Sec. in the direction of the terminal leads                | ≥2.5Kg(24.5N)                             |
| Periodic-pulse Overload       | IEC 60115-1 4.39 | 4 times RCWV 10,000 cycles (1 Sec. on, 25 Sec.off)                            | ±1.0%+0.05Ω                               |
| Damp Heat Steady State        | IEC 60115-1 4.24 | 40±2°C,90-95% RH for 56 days, loaded with 0.1 times RCWV                      | ±1.5%+0.05Ω                               |
| Endurance at 70°C             | IEC 60115-1 4.25 | 70±2°C at RCWV(or Umax., whichever less) for 1,000 Hr.(1.5 Hr.on,0.5 Hr. off) | ±1.5%+0.05Ω                               |
| Temperature Cycling           | IEC 60115-1 4.19 | ➔ -55°C ➔ Room Temp. ➔ +155°C Room Temp.(5 cycles)                            | ±0.75%+0.05Ω                              |
| Resistance to Soldering Heat  | IEC 60115-1 4.18 | 260±3°C for 10±1 Sec., immersed to a point 3±0.5mm from the body              | ±0.25%+0.05Ω                              |

Note:

**RCWV (Rated Continuous Working Voltage ):**

The DC or AC (rms) continuous working voltage corresponding to the rated power is determined by the following formula:

$$V=\sqrt{P \times R}$$

or max. working voltage whichever is less

Where

V=Continuous rated DC or AC (rms) working voltage (V)

P=Rated power (W)

R=Resistance value (Ω)

**PULSE DIAGRAMS**

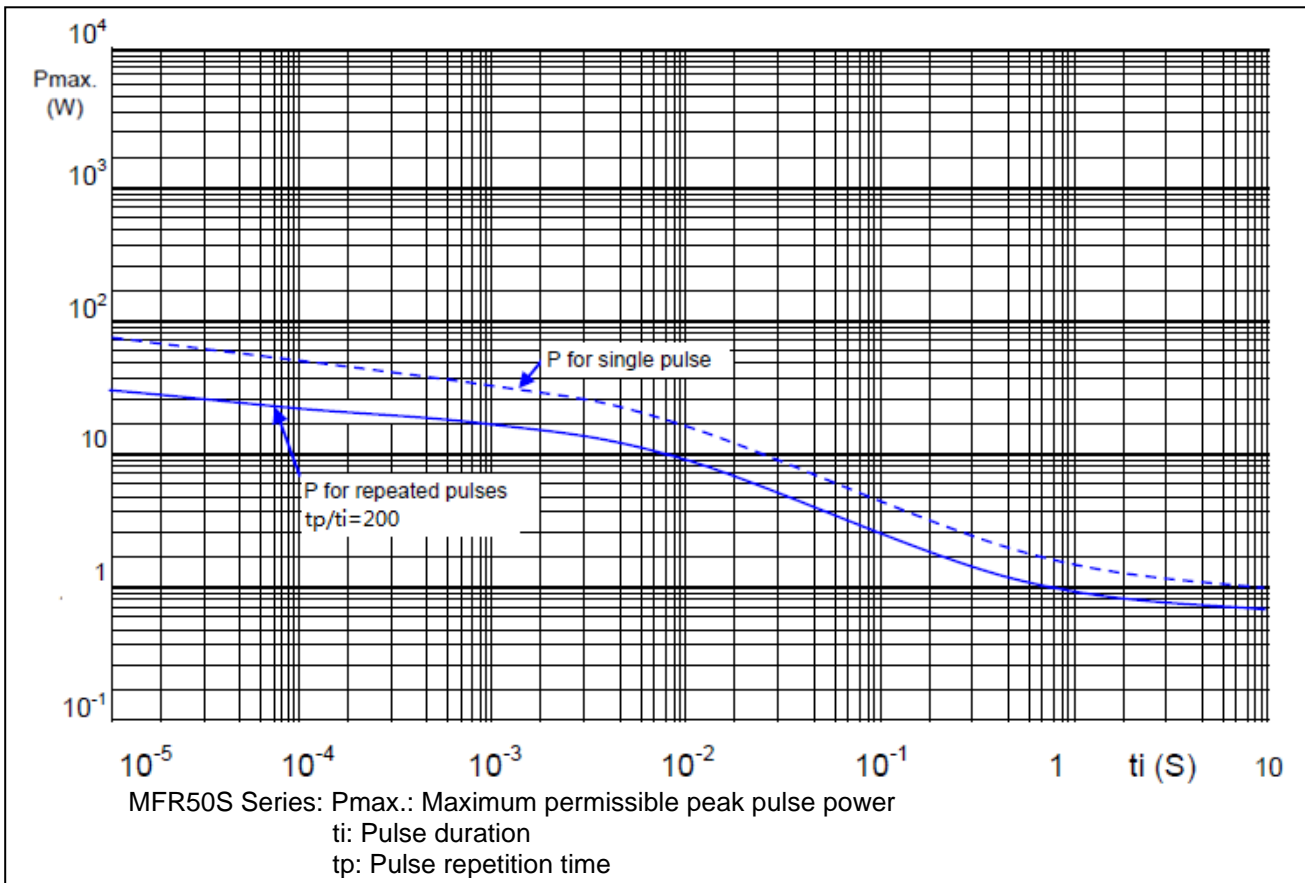
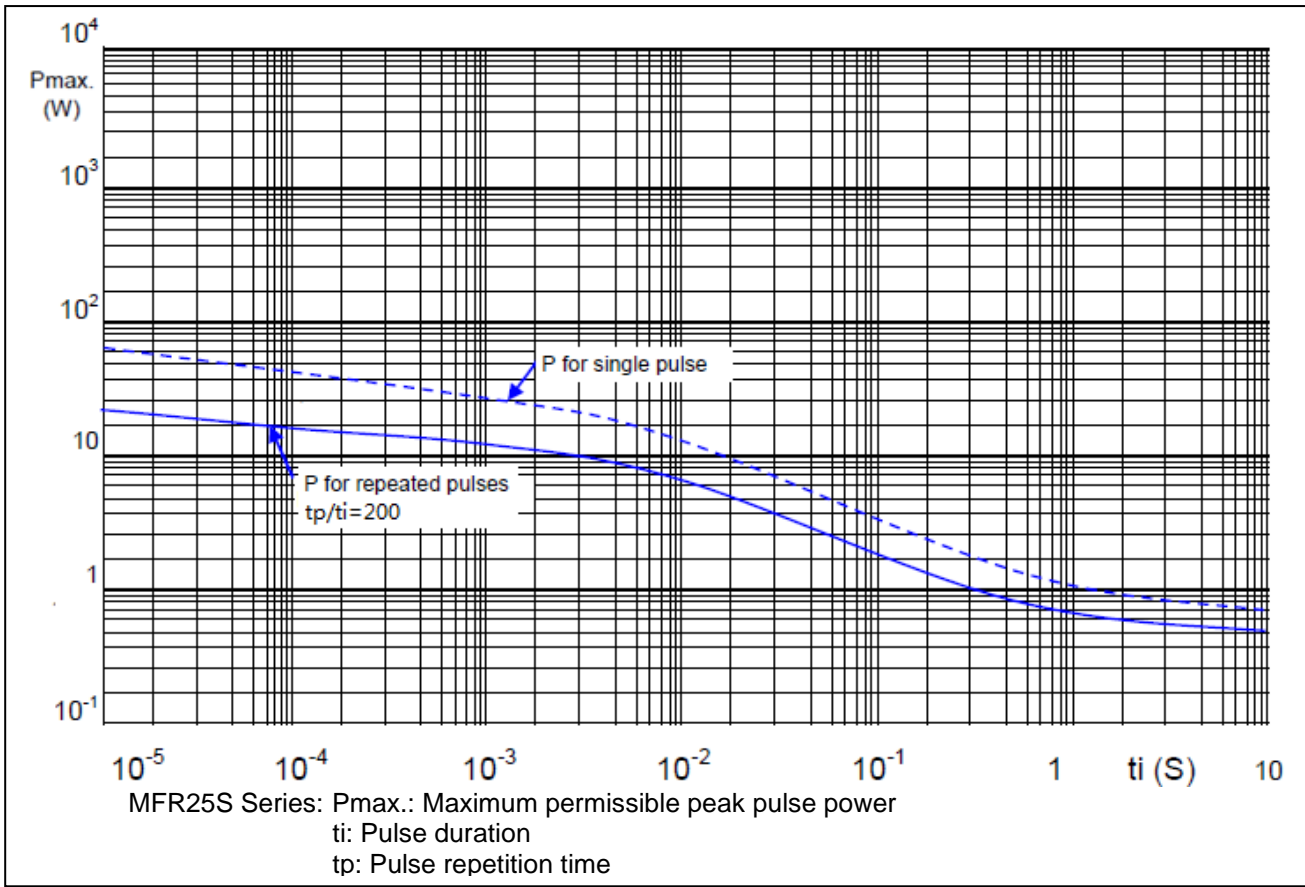

**AXIAL / REEL TAPE SPECIFICATION**

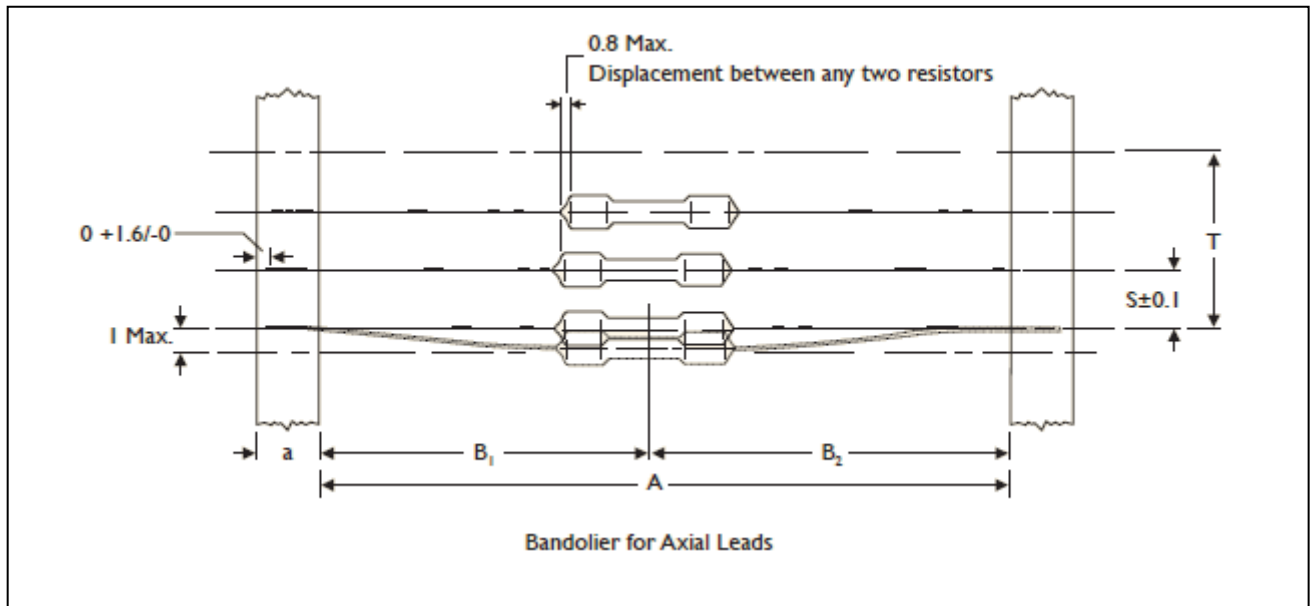

Unit: mm

| Normal | Miniature | a       | A          | B1-B2 (Max.) | S (spacing) | T (max. deviation of spacing)                |
|--------|-----------|---------|------------|--------------|-------------|--|
| MFR-12 | MFR25S    | 6 ± 0.5 | 52.4 ± 1.5 | 1.2          | 5           | 1 mm per 10 spacing,<br>0.5 mm per 5 spacing |
|        |           |         | 26.0 ± 1.5 | 1.0          |             |  |
| MFR-25 | MFR50S    | 6 ± 0.5 | 52.4 ± 1.5 | 1.2          | 5           |  |
|        |           |         | 26.0 ± 1.5 | 1.0          |             |  |
| MFR-50 | MFR1WS    | 6 ± 0.5 | 52.4 ± 1.5 | 1.2          | 5           |  |
| MFR100 | MFR2WS    | 6 ± 0.5 | 73.0 ± 1.5 | 1.5          | 5           |  |
|        |           |         | 52.4 ± 1.5 | 1.2          |             |  |
| MFR200 | MFR3WS    | 6 ± 0.5 | 73.0 ± 1.5 | 1.5          | 10          |  |
|        |           |         | 52.4 ± 1.5 | 1.2          |             |  |

**TAPE ON REEL PACKING**

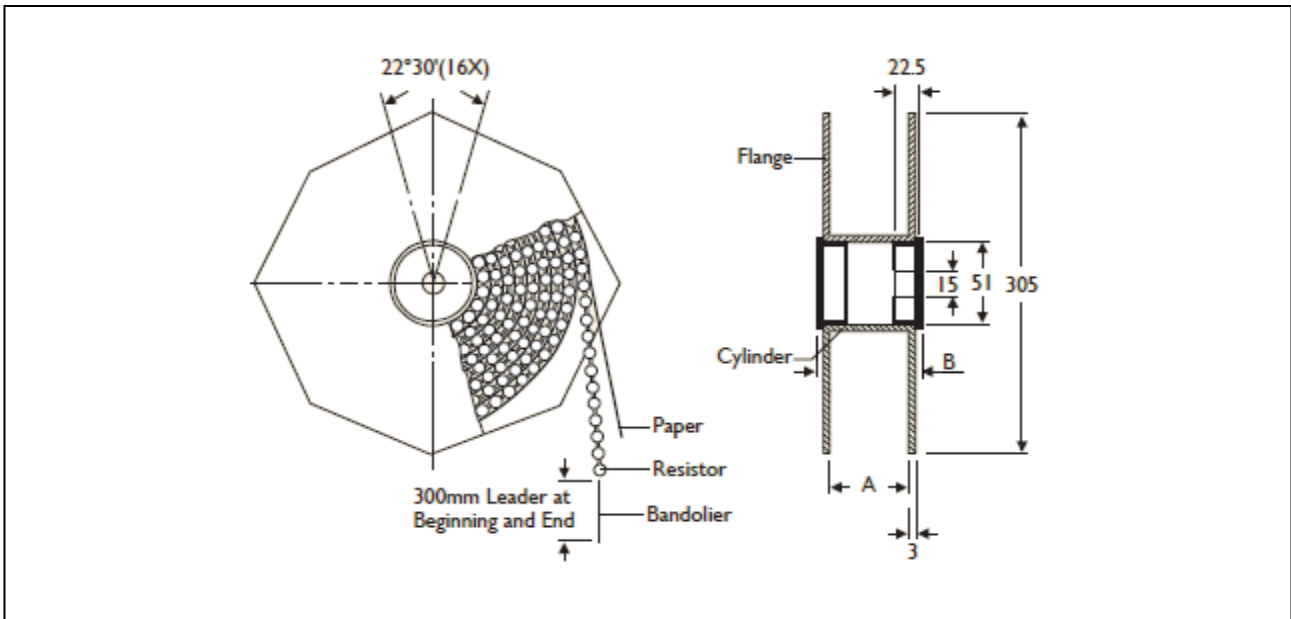

TYPE

Unit: mm/piece

| Normal | Miniature | Across Flange(A) | B    | Quantity Per Reel |
|--------|-----------|------------------|------|-------------------|
| MFR-12 | MFR25S    | 66.5             | 75.5 | 5,000             |
| MFR-25 | MFR50S    | 66.5             | 75.5 | 5,000             |
| MFR-50 | MFR1WS    | 66.5             | 75.5 | 2,500             |
| MFR100 | MFR2WS    | 87               | 96   | 2,000             |
| MFR200 | MFR3WS    | 87               | 96   | 1,000             |

**TAPE ON BOX PACKING**

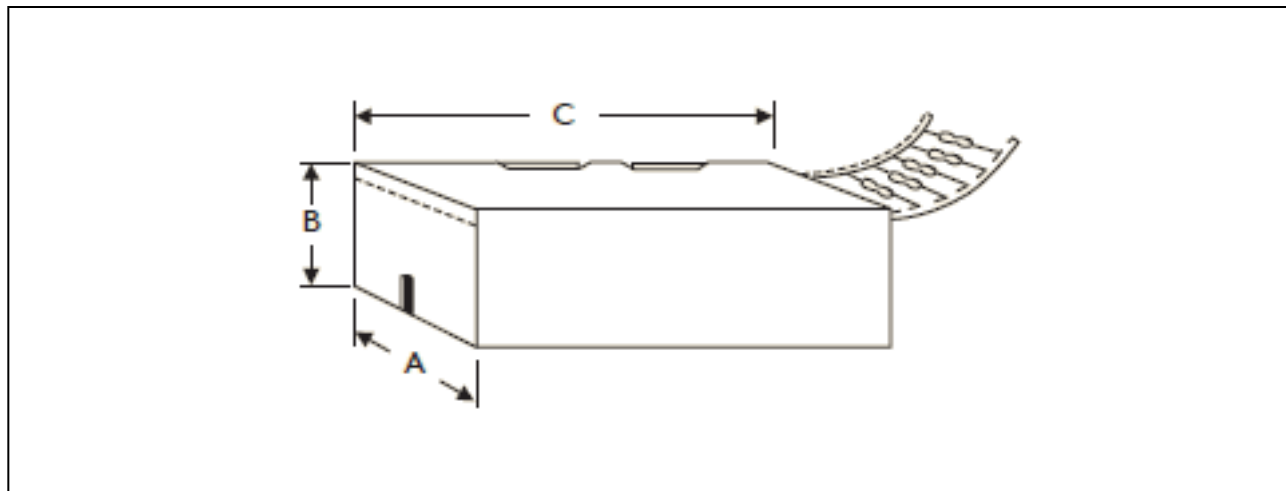

| TYPE   |           | DIMENSIONS |     |     | Unit: mm/piece   |
|--------|-----------|------------|-----|-----|------------------|
| Normal | Miniature | A          | B   | C   | Quantity Per Box |
| MFR-12 | MFR25S    | 48         | 102 | 255 | 5,000            |
| MFR-12 | MFR25S    | 81         | 70  | 260 | 5,000            |
| MFR-25 | MFR50S    | 48         | 102 | 255 | 5,000            |
| MFR-25 | MFR50S    | 81         | 104 | 260 | 5,000            |
| MFR-50 | MFR1WS    | 73         | 45  | 258 | 1,000            |
| MFR100 | MFR2WS    | 81         | 91  | 260 | 1,000            |
| MFR100 | MFR2WS    | 103        | 78  | 260 | 1,000            |
| MFR200 | MFR3WS    | 81         | 91  | 260 | 1,000            |
| MFR200 | MFR3WS    | 103        | 94  | 260 | 1,000            |

**BULK PACKING**

| Normal | Miniature | Piece/Per Inner Box | Bag/Per Inner Box | Piece Per Bag |
|--------|-----------|---------------------|-------------------|---------------|
| MFR-12 | MFR25S    | 10,000              | 10                | 1,000         |
| MFR-25 | MFR50S    | 10,000              | 10                | 1,000         |
| MFR-50 | MFR1WS    | 5,000               | 5                 | 1,000         |
| MFR100 | MFR2WS    | 2,000               | 4                 | 500           |
| MFR200 | MFR3WS    | 1,000               | 2                 | 500           |

**FORMING**

**M TYPE**

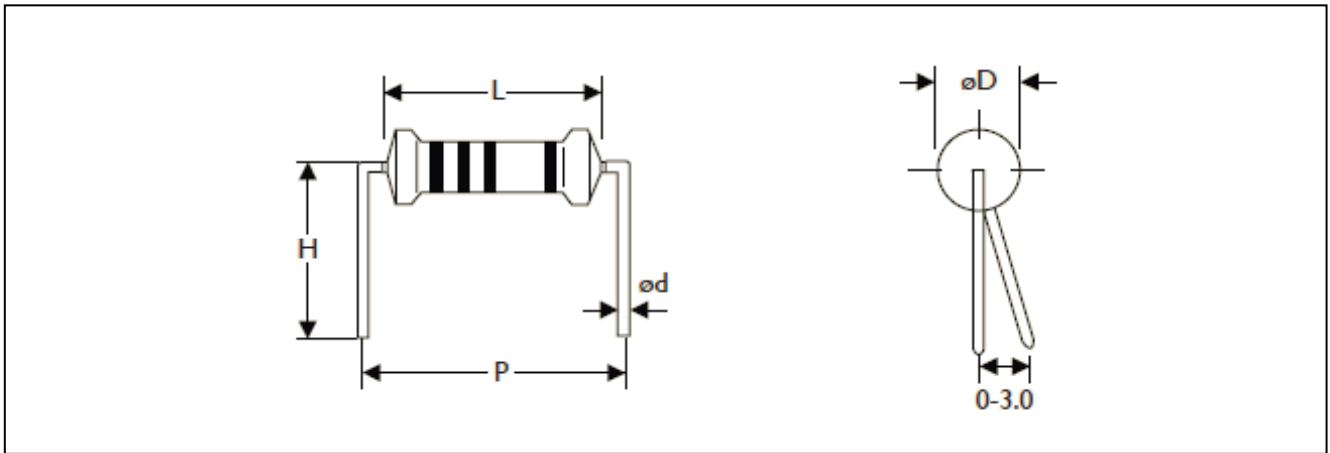

| TYPE   |           | DIMENSIONS |           |             |          |          | Unit: mm |
|--------|-----------|------------|-----------|-------------|----------|----------|----------|
| Normal | Miniature | L          | ψD        | ψd          | P        | H        |          |
| MFR-12 | MFR25S    | 3.4 ± 0.3  | 1.9 ± 0.2 | 0.45 ± 0.05 | 6.0 ± 1  | 10.0 ± 1 |          |
| MFR-25 | MFR50S    | 6.3 ± 0.5  | 2.4 ± 0.2 | 0.55 ± 0.05 | 10.0 ± 1 | 10.0 ± 1 |          |
| MFR-50 | MFR1WS    | 9.0 ± 0.5  | 3.3 ± 0.3 | 0.55 ± 0.05 | 12.5 ± 1 | 10.0 ± 1 |          |
| MFR100 | MFR2WS    | 11.5 ± 1.0 | 4.5 ± 0.5 | 0.8 ± 0.05  | 15.0 ± 1 | 12.5 ± 1 |          |
| MFR200 | MFR3WS    | 15.5 ± 1.0 | 5.0 ± 0.5 | 0.8 ± 0.05  | 20.0 ± 1 | 15.0 ± 1 |          |

**MB TYPE**

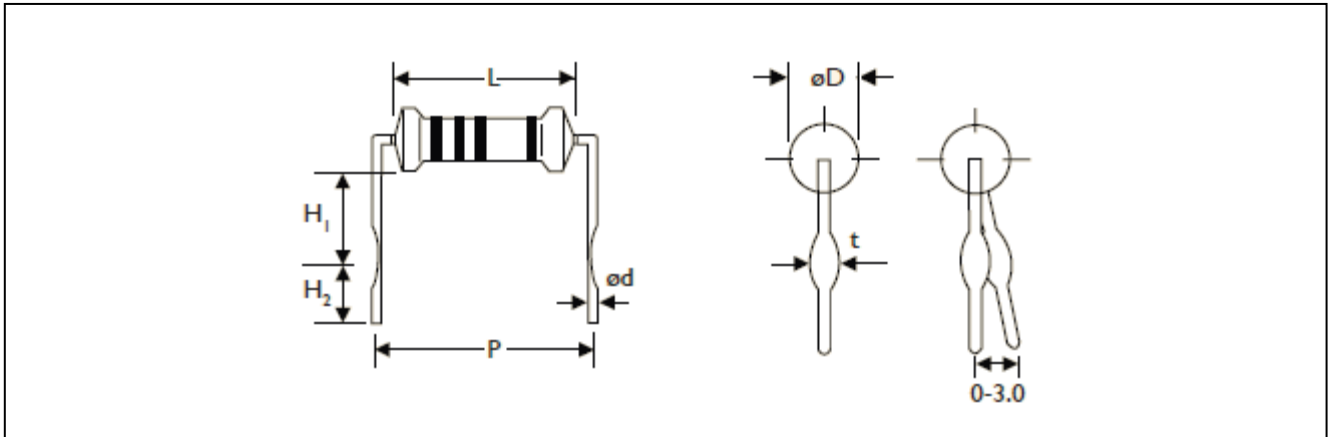

| TYPE   |           | DIMENSIONS     |               |                 |              |              |             |               | Unit: mm |
|--------|-----------|----------------|---------------|-----------------|--------------|--------------|-------------|---------------|----------|
| Normal | Miniature | L              | $\psi D$      | $\psi d$        | P            | H1           | H2          | t             |          |
| MFR-25 | MFR50S    | $6.3 \pm 0.5$  | $2.4 \pm 0.2$ | $0.55 \pm 0.05$ | $10.0 \pm 1$ | $6.0 \pm 1$  | $5.0 \pm 1$ | $1.2 \pm 0.2$ |          |
| MFR-50 | -         | $9.0 \pm 0.5$  | $3.3 \pm 0.3$ | $0.55 \pm 0.05$ | $12.5 \pm 1$ | $6.0 \pm 1$  | $5.0 \pm 1$ | $1.2 \pm 0.2$ |          |
| -      | MFR1WS    | $9.0 \pm 0.5$  | $3.3 \pm 0.3$ | $0.8 \pm 0.05$  | $12.5 \pm 1$ | $6.0 \pm 1$  | $5.0 \pm 1$ | $1.4 \pm 0.2$ |          |
| MFR100 | MFR2WS    | $11.5 \pm 1.0$ | $4.5 \pm 0.5$ | $0.8 \pm 0.05$  | $15.0 \pm 1$ | $6.0 \pm 1$  | $5.0 \pm 1$ | $1.4 \pm 0.2$ |          |
| MFR200 | MFR3WS    | $15.5 \pm 1.0$ | $5.0 \pm 0.5$ | $0.8 \pm 0.05$  | $20.0 \pm 1$ | $10.0 \pm 1$ | $5.0 \pm 1$ | $1.4 \pm 0.2$ |          |

**MHA TYPE**

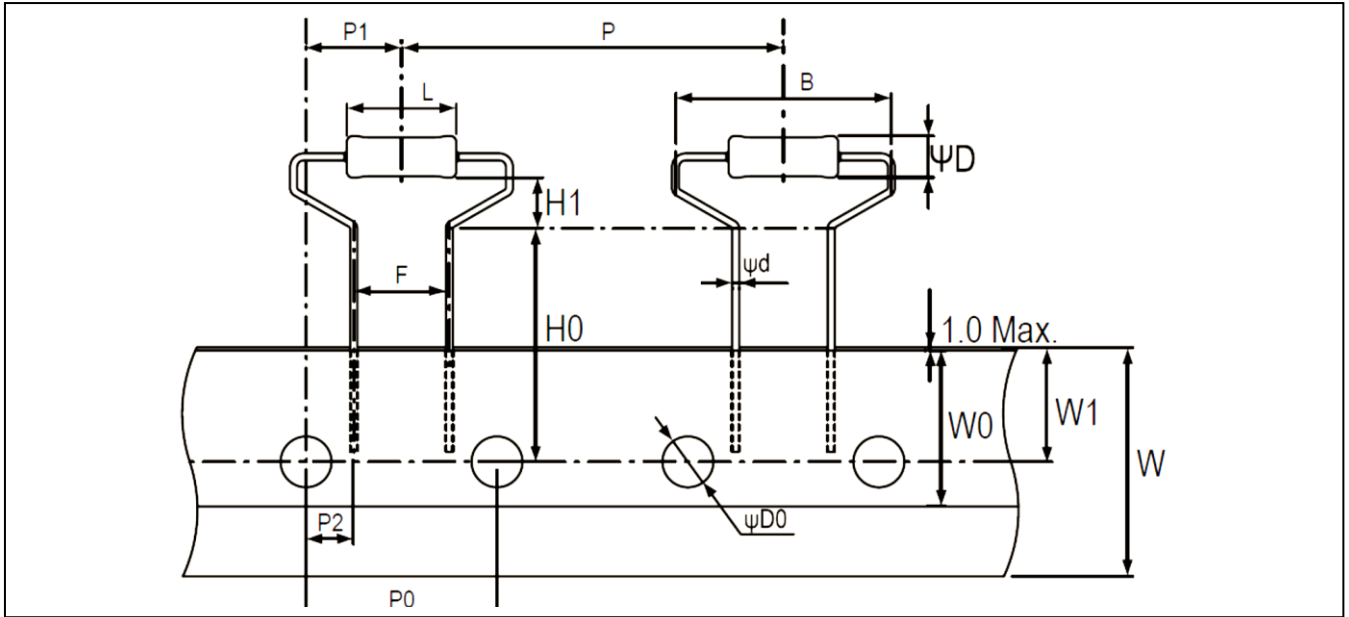

| TYPE          |                  | DIMENSIONS |             |             |          |           |           |              |           | Unit: mm |
|---------------|------------------|------------|-------------|-------------|----------|-----------|-----------|--------------|-----------|----------|
| <b>Normal</b> | <b>Miniature</b> | <b>L</b>   | <b>psiD</b> | <b>psiD</b> | <b>B</b> | <b>H0</b> | <b>H1</b> | <b>P</b>     | <b>P0</b> |          |
|               |                  | 9.0±0.5    | 3.3±0.3     | 0.55±0.05   | 17.5Max  | 19.0±1.0  | 4.0±1.0   | 30.0±1.0     | 15.0±0.3  |          |
| MFR-50        | MFR1WS           | <b>P1</b>  | <b>P2</b>   | <b>F</b>    | <b>W</b> | <b>W0</b> | <b>W1</b> | <b>psiD0</b> |           |          |
|               |                  | 7.5±1.0    | 3.75±0.5    | 7.5±0.5     | 18.0±0.5 | 5.0Min    | 9.0±0.5   | 4.0±0.2      |           |          |

**MHB TYPE**

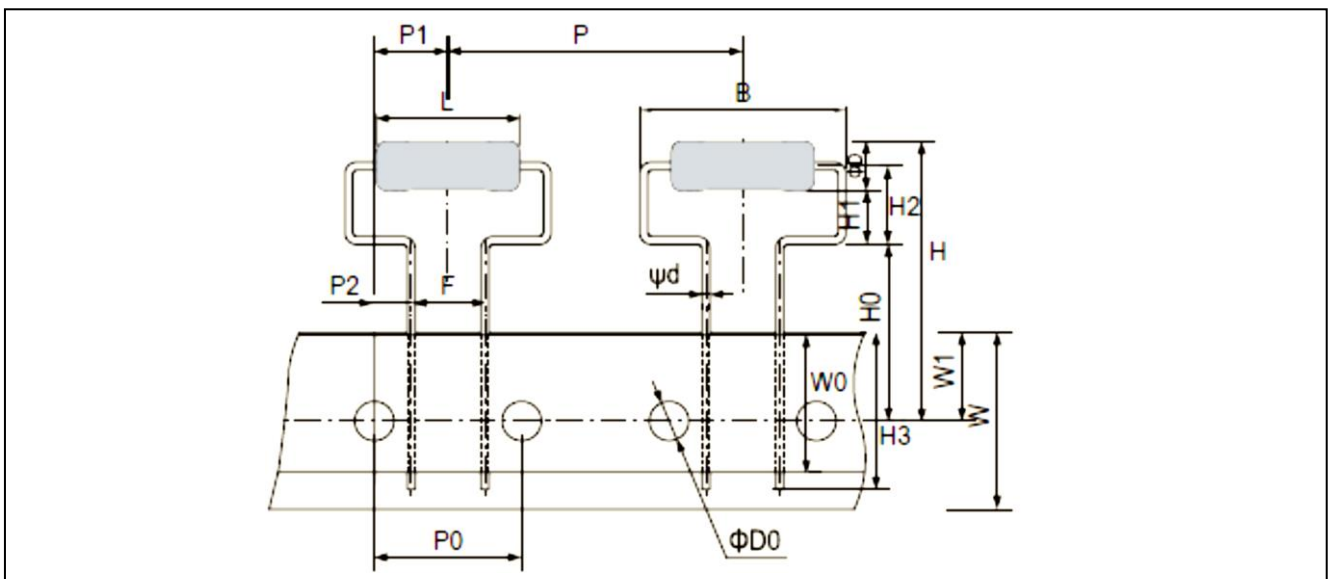

| TYPE          |                  | DIMENSIONS |             |             |           |          |           |           |           |              | Unit: mm |
|---------------|------------------|------------|-------------|-------------|-----------|----------|-----------|-----------|-----------|--------------|----------|
| <b>Normal</b> | <b>Miniature</b> | <b>L</b>   | <b>psiD</b> | <b>psiD</b> | <b>B</b>  | <b>H</b> | <b>H0</b> | <b>H1</b> | <b>H2</b> | <b>H3</b>    |          |
|               |                  | 15.5±1.0   | 5.0±0.5     | 0.8±0.05    | 21.0Max.  | 30Max.   | 18.0±1.0  | 5.5(Ref.) | 8.0±1.5   | 16Max.       |          |
| MFR200        | MFR3WS           | <b>P</b>   | <b>P0</b>   | <b>P1</b>   | <b>P2</b> | <b>F</b> | <b>W</b>  | <b>W0</b> | <b>W1</b> | <b>psiD0</b> |          |
|               |                  | 30.0±1.0   | 15.0±0.3    | 7.5±1.0     | 3.75±0.8  | 7.5±0.5  | 18.0±0.5  | 5.0Min.   | 9.0±0.5   | 4.0±0.3      |          |

**MHC TYPE**

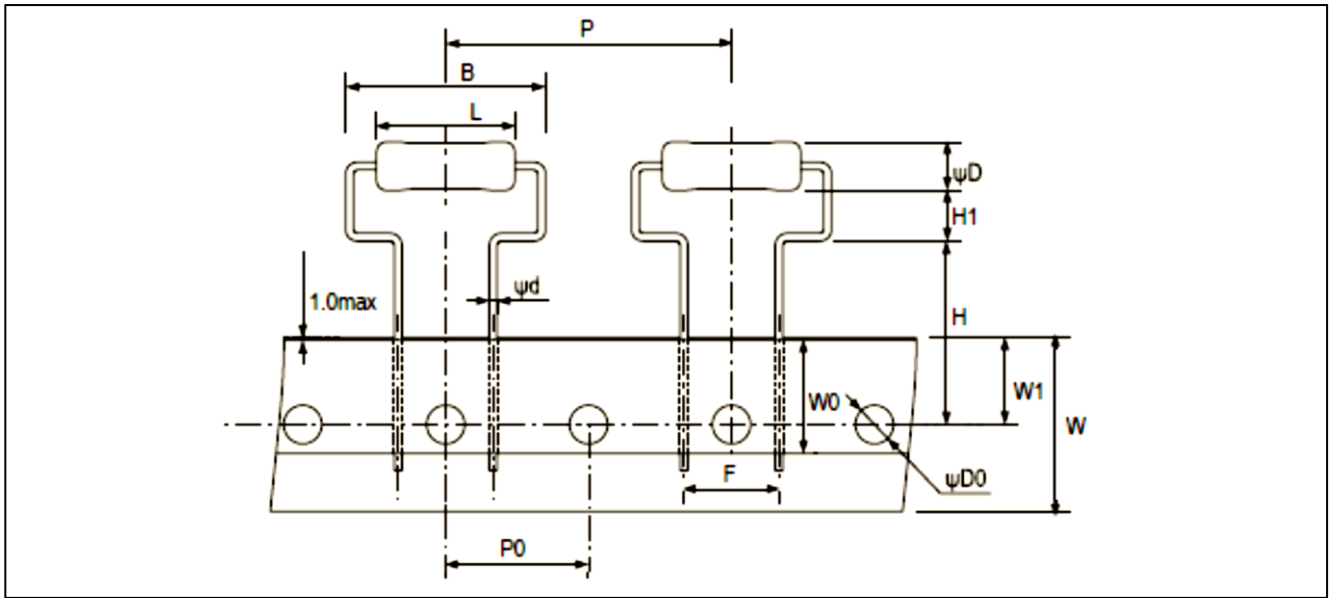

| TYPE          |                  | DIMENSIONS |           |           |           |            |           |          |           | Unit: mm |
|---------------|------------------|------------|-----------|-----------|-----------|------------|-----------|----------|-----------|----------|
| <b>Normal</b> | <b>Miniature</b> | <b>L</b>   | <b>ψD</b> | <b>ψd</b> | <b>B</b>  | <b>H</b>   | <b>HI</b> | <b>P</b> | <b>P0</b> |          |
|               |                  | 15.5±1.0   | 5.0±0.5   | 0.8±0.05  | 21.0Max.  | 19.0±1.0   | 5.25±1.0  | 30.0±1.0 | 15.0±0.3  |          |
| MFR200        | MFR3WS           | <b>F</b>   | <b>W</b>  | <b>W0</b> | <b>W1</b> | <b>ψD0</b> |           |          |           |          |
|               |                  | 10.0±0.5   | 18.0±0.5  | 5.0Min.   | 9.0±0.5   | 4.0±0.2    |           |          |           |          |

**F TYPE**

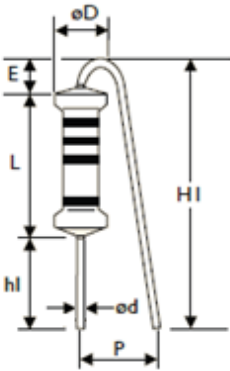

**FK TYPE**

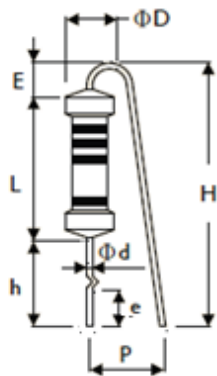

**FFK TYPE**

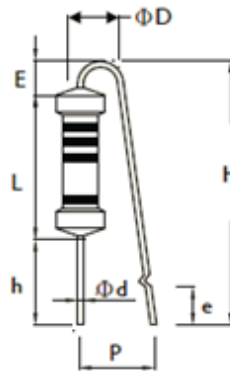

**FKK TYPE**

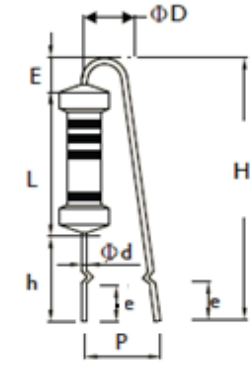

| TYPE          |                  | DIMENSIONS |           |           |          |          |               |           |           |               |          | Unit: mm |
|---------------|------------------|------------|-----------|-----------|----------|----------|---------------|-----------|-----------|---------------|----------|----------|
| <b>Normal</b> | <b>Miniature</b> | <b>L</b>   | <b>ψD</b> | <b>ψd</b> | <b>P</b> | <b>h</b> | <b>H Max.</b> | <b>h1</b> | <b>HI</b> | <b>E Max.</b> | <b>e</b> |          |
| MFR-50        | MFR1WS           | 9.0±0.5    | 3.3±0.3   | 0.55±0.05 | 6±1      | 8±1      | 22            | 5±1       | 18.5 Max. | 3.5           | 3.5±1    |          |
| MFR100        | MFR2WS           | 11.5±1     | 4.5±0.5   | 0.8±0.05  | 6±1      | 8±1      | 24            | 5±1       | 20 Max.   | 3.5           | 3.5±1    |          |
| MFR200        | MFR3WS           | 15.5±1     | 5.0±0.5   | 0.8±0.05  | 8±1      | 8±1      | 28            | 5±1       | 25 Max.   | 3.5           | 3.5±1    |          |

**FB- TYPE (for -25&50S)**

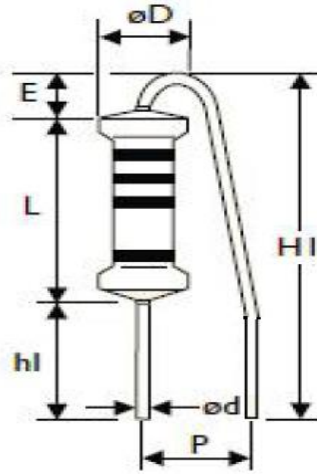

| TYPE   |           | DIMENSIONS    |               |                 |           |               |                | Unit: mm  |  |
|--------|-----------|---------------|---------------|-----------------|-----------|---------------|----------------|-----------|--|
| Normal | Miniature | L             | $\psi D$      | $\psi d$        | P         | hI            | HI             | E<br>Max. |  |
| MFR-25 | MFR50S    | $6.3 \pm 0.5$ | $2.4 \pm 0.2$ | $0.55 \pm 0.05$ | $6 \pm 1$ | $5.5 \pm 0.5$ | $13.5 \pm 0.5$ | 3.5       |  |

**FT TYPE (Taping Pack)**

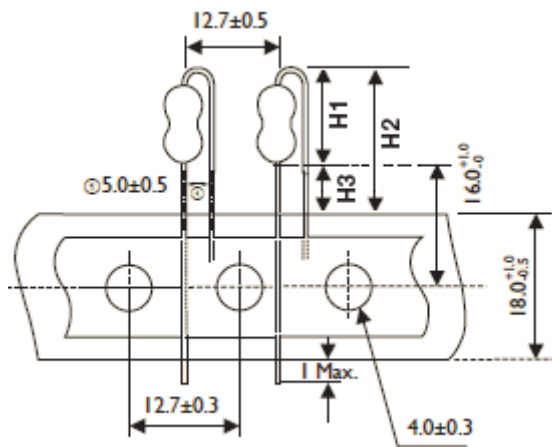

**MT TYPE (Taping Pack)**

Rated Watts : 1/6W,1/4WS

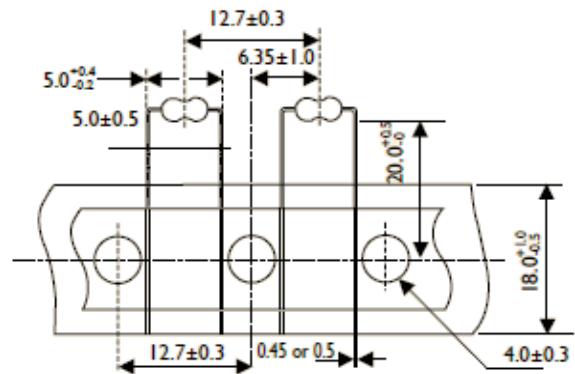

| TYPE   |           | DIMENSIONS |            |            | Unit: mm |
|--------|-----------|------------|------------|------------|----------|
| Normal | Miniature | H1<br>Max. | H2<br>Max. | H3<br>Max. |          |
| MFR-25 | MFR50S    | 10         | 18.5       | 8.5        |          |
| MFR-50 | MFR1WS    | 13         | 21.5       | 8.5        |          |
| MFR100 | MFR2WS    | 16         | 24.5       | 8.5        |          |

**PN TYPE (Taping Pack)**

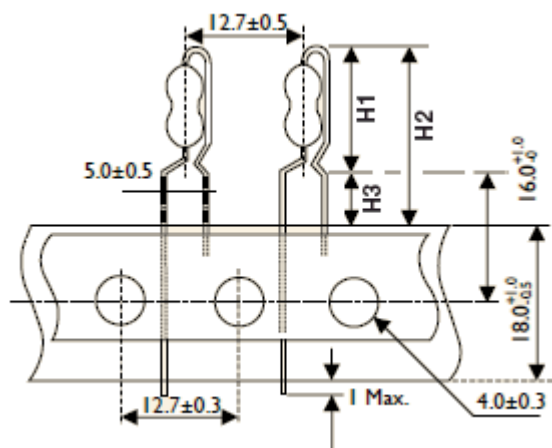

**AV TYPE (Taping Pack)**

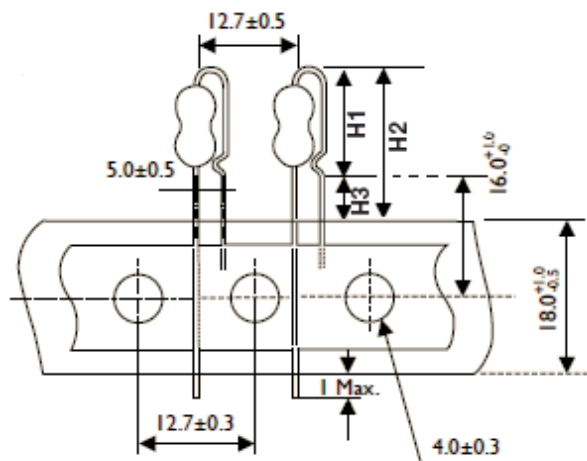

| TYPE   |           | DIMENSIONS |            |            | Unit: mm |
|--------|-----------|------------|------------|------------|----------|
| Normal | Miniature | H1<br>Max. | H2<br>Max. | H3<br>Max. |          |
| MFR-25 | MFR50S    | 13         | 21.5       | 8.5        |          |
| MFR-50 | MFR1WS    | 17         | 25.5       | 8.5        |          |
| MFR100 | MFR2WS    | 19         | 27.5       | 8.5        |          |

| TYPE   |           | DIMENSIONS |            |            | Unit: mm |
|--------|-----------|------------|------------|------------|----------|
| Normal | Miniature | H1<br>Max. | H2<br>Max. | H3<br>Max. |          |
| MFR-25 | MFR50S    | 11.5       | 20         | 8.5        |          |
| MFR-50 | MFR1WS    | 14.5       | 23         | 8.5        |          |
| MFR100 | MFR2WS    | 17.5       | 26         | 8.5        |          |

**MARKING**

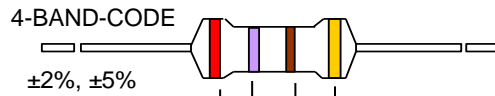

| COLOR  | 1st BAND | 2nd BAND | 3rd BAND | MULTIPLIER | TOLERANCE     |
|--------|----------|----------|----------|------------|---------------|
| BLACK  | 0        | 0        | 0        | 1Ω         |               |
| BROWN  | 1        | 1        | 1        | 10Ω        | ± 1% ( F )    |
| RED    | 2        | 2        | 2        | 100Ω       | ± 2% ( G )    |
| ORANGE | 3        | 3        | 3        | 1KΩ        |               |
| YELLOW | 4        | 4        | 4        | 10KΩ       |               |
| GREEN  | 5        | 5        | 5        | 100K       | ± 0.5 % ( D ) |
| BLUE   | 6        | 6        | 6        | 1MΩ        |               |
| VIOLET | 7        | 7        | 7        | 10MΩ       |               |
| GREY   | 8        | 8        | 8        | 0.001Ω     |               |
| WHITE  | 9        | 9        | 9        | 0.0001Ω    |               |
| GOLD   |          |          |          | 0.1Ω       | ± 5 % ( J )   |
| SILVER |          |          |          | 0.01Ω      |               |

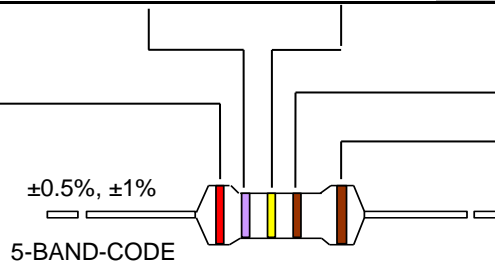

**REVISION HISTORY**

| REVISION  | DATE         | CHANGE NOTIFICATION | DESCRIPTION  |
|-----------|--------------|---------------------|--|
| Version 4 | Apr.2, 2024  | -                   | - Added forming code description for part number   |
| Version 3 | Sep.6, 2023  | -                   | - Updated legal disclaimer and footer versions numbers                                   |
| Version 2 | Aug.31, 2022 | -                   | - Add FB- forming code to -25&50S<br>- Will EOL F forming code to -25&50S on Feb.28,2023 |
| Version 1 | Sep.28, 2021 | -                   | - Add F TYPE for -25&50S power   |
| Version 0 | Aug.2, 2021  | -                   | - First issue of this specification  |

*“ Yageo reserves all the rights for revising the content of this datasheet without further notification, as long as the products itse lf are unchanged. Any product change will be announced by PCN.”*

## LEGAL DISCLAIMER

YAGEO, its distributors and agents (collectively, "YAGEO"), hereby disclaims any and all liabilities for any errors, inaccuracies or incompleteness contained in any product related information, including but not limited to product specifications, datasheets, pictures and/or graphics. YAGEO may make changes, modifications and/or improvements to product related information at any time and without notice.



YAGEO makes no representation, warranty, and/or guarantee about the fitness of its products for any particular purpose or the continuing production of any of its products. To the maximum extent permitted by law, YAGEO disclaims (i) any and all liability arising out of the application or use of any YAGEO product, (ii) any and all liability, including without limitation special, consequential or incidental damages, and (iii) any and all implied warranties, including warranties of fitness for a particular purpose, non-infringement and merchantability.

YAGEO products are designed for general purpose applications under normal operation and usage conditions. Please contact YAGEO for the applications listed below which require especially high reliability for the prevention of defects which might directly cause damage to the third party's life, body or property: Aerospace equipment (artificial satellite, rocket, etc.), Atomic energy-related equipment, Aviation equipment, Disaster prevention equipment, crime prevention equipment, Electric heating apparatus, burning equipment, Highly public information network equipment, data-processing equipment, Medical devices, Military equipment, Power generation control equipment, Safety equipment, Traffic signal equipment, Transportation equipment and Undersea equipment, or for any other application or use in which the failure of YAGEO products could result in personal injury or death, or serious property damage. Particularly **YAGEO Corporation and its affiliates do not recommend the use of commercial or automotive grade products for high reliability applications or manned space flight.**

Information provided here is intended to indicate product specifications only. YAGEO reserves all the rights for revising this content without further notification, as long as products are unchanged. Any product change will be announced by PCN.

## Looking for pricing, stock, or lifecycle information?

Click below to explore more details on WIN SOURCE:

-  [View MFR-25FTE52-10K on WIN SOURCE](#)
-  [Yageo Information](#)

## Optimize Your Supply Chain with WIN SOURCE Solutions

-  Global Sourcing Solution
-  Obsolete Management
-  Cost Control Management
-  Shortage Management
-  Alternative Solution
-  Excess Inventory Management