

DATA SHEET

CURRENT SENSOR - LOW TCR

PE series

5%, 1%

sizes 0603/0805/1206/2010/2512/4527

RoHS compliant & Halogen free



SCOPE

This specification describes PE series current sensor - low TCR with lead-free terminations made by metal foil with ceramic substrate.

APPLICATIONS

- Consumer goods
- Computer
- Telecom / Datacom
- Industrial / Power supply
- Alternative Energy

FEATURES

- Halogen-free Epoxy
- RoHS compliant
- Reduce environmentally hazardous wastes
- High component and equipment reliability
- Non-forbidden materials used in products/production
- Low resistances applied to current sensing

ORDERING INFORMATION - GLOBAL PART NUMBER

Global part numbers are identified by the series, size, tolerance, packing type, temperature coefficient, taping reel and resistance value.

GLOBAL PART NUMBER

PE XXXX X X X XX XXXX Z
 (1) (2) (3) (4) (5) (6) (7)

(1) SIZE

0603 / 0805 / 1206 / 2010 / 2512 / 4527

(2) TOLERANCE

F = ±1%
 J = ±5%

(3) PACKAGING TYPE

R = Paper taping reel
 K = Embossed taping reel

(4) TEMPERATURE COEFFICIENT OF RESISTANCE

E = ±50 ppm/°C
 M = ±75 ppm/°C
 F = ±100 ppm/°C

(5) TAPING REEL

07 / 7W / 7T / 47 / 57 = 7 inch dia. Reel and specific rated power.
 Detailed power rating are shown in the Table 2.

(6) RESISTANCE VALUE

1 mΩ to 910 mΩ
 There are 3~5 digits indicated the resistance value. Letter R is decimal point.
 Detailed coding rules of resistance are shown in the table of "Resistance rule of global part number".

(7) DEFAULT CODE

Letter Z is the system default code for ordering only. (Note)

Resistance rule of global part number	
Resistance code rule	Example
	0R001 = 1 mΩ
0RXXX	0R1 = 100 mΩ
(1 to 910 mΩ)	0R91 = 910 mΩ

ORDERING EXAMPLE

The ordering code of a PE2512 1W chip resistor, value 0.006 Ω with ±1% tolerance, supplied in 7-inch tape reel is:
PE2512FKM070R006Z

NOTE

1. All our Rchip products are RoHS compliant. "LFP" of the internal 2D reel label mentions "Lead-Free Process"

MARKING

PE0603



2 digits

Fig. 1 Value = 10 mΩ

PE0805



3 digits

Fig. 2 Value = 10 mΩ

PE1206 / PE2010 / PE2512 / PE4527



4 digits

Fig. 3 Value = 33 mΩ

The "R" is used as a decimal point; the other 3 digits are significant

CONSTRUCTION

The resistors are constructed using outstanding TCR level material, which makes Yageo PE resistors excellent for current sensing application in battery charger circuit & DC-DC converter.

The composition of the resistive material is adjusted to give the approximate required resistance and is covered with a protective coating. Marking is printed on the top side of the resistor.

Finally, the three external terminations (Cu / Ni / matte Tin) are added, as shown in Fig. 4.

Outlines

For dimensions, please refer to Table I

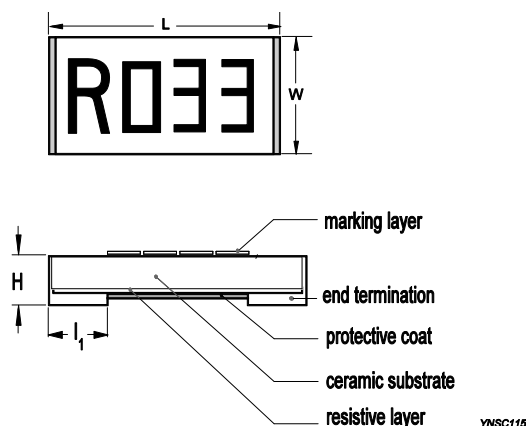

Fig. 4 Chip resistor outlines

DIMENSION
Table 1 For outlines, please refer to Fig. 4

TYPE	RESISTANCE RANGE	L (mm)	W (mm)	H (mm)	l ₁ (mm)
PE0603	5 mΩ ≤ R ≤ 100 mΩ	1.60±0.25	0.80±0.25	0.60±0.25	0.40±0.25
	4 mΩ	2.00±0.25	1.25±0.25	0.60±0.25	0.70±0.25
PE0805	5 mΩ	2.00±0.25	1.25±0.25	0.60±0.25	0.73±0.25
	6 mΩ	2.00±0.25	1.25±0.25	0.60±0.25	0.65±0.25
	7mΩ ≤ R ≤ 100 mΩ	2.00±0.25	1.25±0.25	0.60±0.25	0.50±0.25
PE1206	4 mΩ	3.20±0.25	1.60±0.25	0.60±0.25	1.20±0.25
	5 mΩ ≤ R ≤ 8 mΩ	3.20±0.25	1.60±0.25	0.60±0.25	1.15±0.25
	9 mΩ ≤ R ≤ 100 mΩ	3.20±0.25	1.60±0.25	0.60±0.25	0.58±0.25
PE2010	5 mΩ ≤ R ≤ 9 mΩ	5.00±0.25	2.50±0.25	0.60±0.25	1.50±0.25
	10 mΩ ≤ R ≤ 100 mΩ	5.00±0.25	2.50±0.25	0.60±0.25	0.60±0.25
PE2512	5 mΩ	6.45±0.25	3.25±0.25	0.70±0.25	1.95±0.25
	6 mΩ ≤ R ≤ 8mΩ	6.45±0.25	3.25±0.25	0.70±0.25	1.90±0.25
	9 mΩ ≤ R < 100 mΩ	6.45±0.25	3.25±0.25	0.70±0.25	0.95±0.25
	100mΩ	6.45±0.25	3.25±0.25	0.70±0.25	0.60±0.25
PE4527	5 mΩ	11.50±0.25	7.00±0.25	0.60±0.25	2.90±0.25
	6 mΩ ≤ R <910 mΩ	11.50±0.25	7.00±0.25	0.60±0.25	2.60±0.25

Note:

1. For relevant physical dimensions, please refer to construction outlines.
2. Please contact with sales offices, distributors and representatives in your region before ordering.

ELECTRICAL CHARACTERISTICS

Table 2

SERIES	SIZE	POWER RATING (1)					TOLERANCE	RESISTANCE RANGE	TEMPERATURE COEFFICIENT OF RESISTANCE
		07	7W	7T	47	57			
PE	0603	1/10W	1/5W	1/3W	2/5W	1/2W		5 mΩ ≤ R ≤ 100 mΩ	
	0805	1/8W	1/4W	1/3W	1/2W	---		4 mΩ ≤ R ≤ 100 mΩ	
	1206	1/4W	1/2W	---	1W	---	±1%	4 mΩ ≤ R ≤ 100 mΩ	±50 ppm/°C
	2010	1/2W	1W	---	---	---	±5%	5 mΩ ≤ R ≤ 100 mΩ	±75 ppm/°C
	2512	1W	2W	---	---	---		5 mΩ ≤ R ≤ 100 mΩ	±100 ppm/°C
	4527	2W	3W	---	---	---		5 mΩ ≤ R < 910 mΩ	

- Note: 1. Global part number (code 10 - 11)
 2. Please contact with sales offices, distributors and representatives in your region before ordering.

FUNCTIONAL DESCRIPTION

OPERATING TEMPERATURE RANGE

Range: -55°C to +170°C

POWER RATING

Standard rated power at 70°C:

- PE0603 = 1/10W
- PE0805 = 1/8W
- PE1206 = 1/4W
- PE2010 = 1/2W
- PE2512 = 1W
- PE4527 = 2W

For detail power value, please refer to Table 2.

RATED VOLTAGE

The DC or AC (rms) continuous working voltage corresponding to the rated power is determined by the following formula:

$$V = \sqrt{P \times R}$$

Where

V = Continuous rated DC or AC (rms) working voltage (V)

P = Rated power (W)

R = Resistance value (Ω)

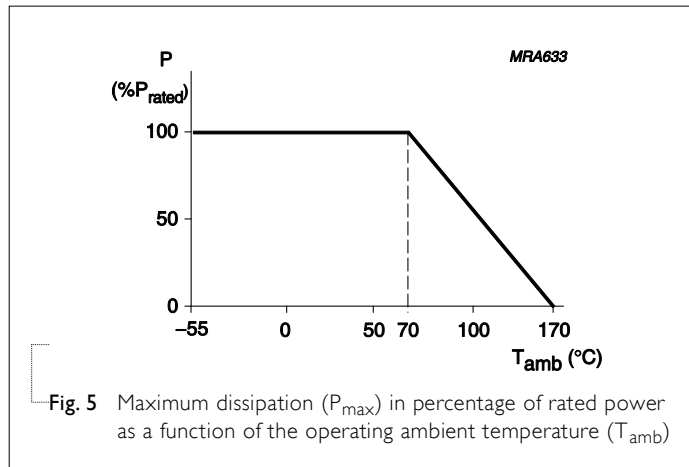

Fig. 5 Maximum dissipation (P_{max}) in percentage of rated power as a function of the operating ambient temperature (T_{amb})

PACKING STYLE AND PACKAGING QUANTITY

Table 3 Packing style and packaging quantity

PACKING STYLE	REEL DIMENSION	PE0603	PE0805	PE1206	PE2010	PE2512	PE4527
Paper taping reel (R)	7" (178 mm)	5,000	5,000	---	---	---	---
Embossed taping reel (K)	7" (178 mm)	---	---	4,000	4,000	4,000	1,000

PAPER TAPE

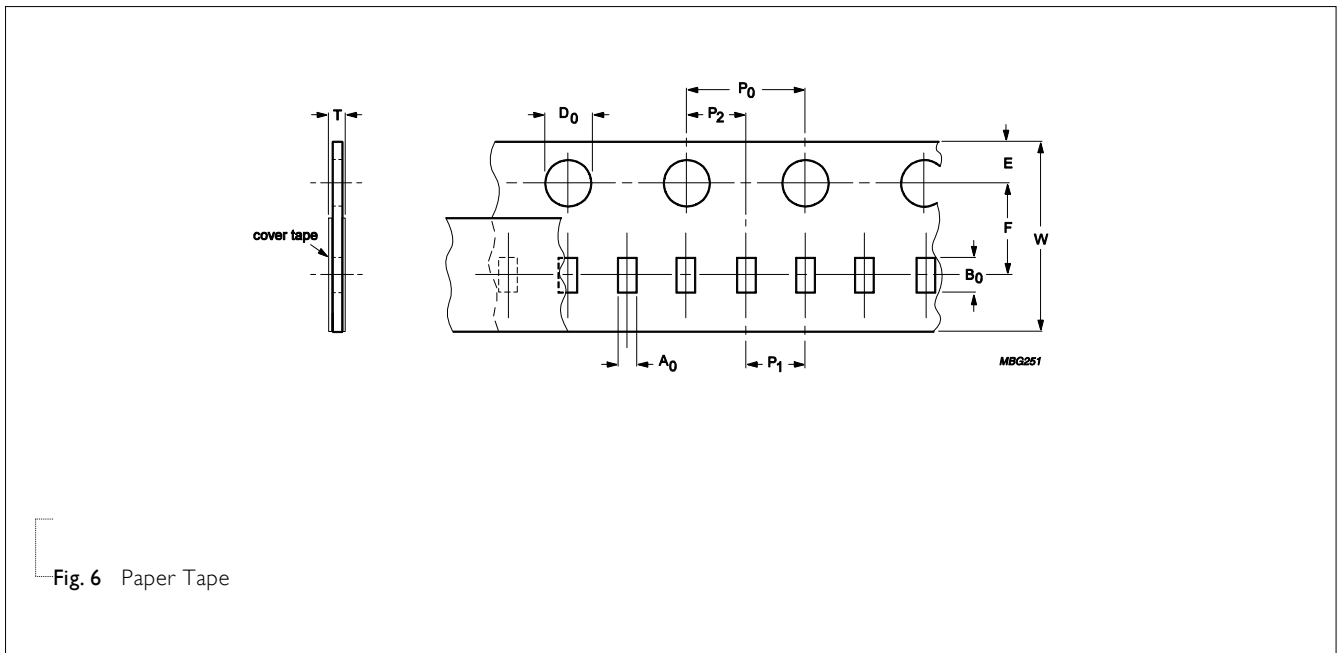

Fig. 6 Paper Tape

Table 4 Dimensions of paper tape for relevant chip resistors size

SIZE	SYMBOL										Unit: mm
	A ₀	B ₀	W	E	F	P ₀	P ₁	P ₂	ØD ₀	T	
PE0603	1.20±0.15	1.90±0.15	8.00±0.30	1.75±0.10	3.50±0.10	4.00±0.10	4.00±0.10	2.00±0.10	1.50±0.10	0.55±0.15	
PE0805	1.60±0.15	2.30±0.15	8.00±0.30	1.75±0.10	3.50±0.10	4.00±0.10	4.00±0.10	2.00±0.10	1.50±0.10	0.85±0.15	

EMBOSSED TAPE

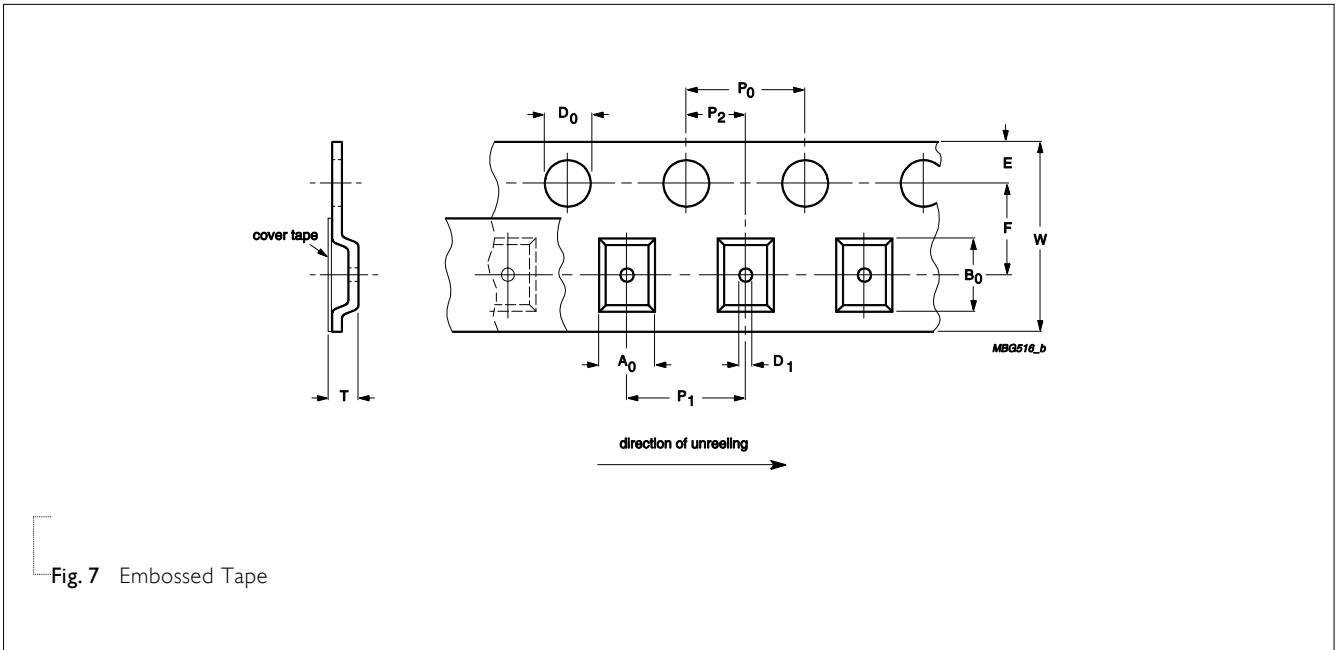

Fig. 7 Embossed Tape

Table 5 Dimensions of embossed tape for relevant chip resistors size

SIZE	SYMBOL										Unit: mm
	A ₀	B ₀	W	E	F	P ₀	P ₁	P ₂	ØD ₀	ØD ₁	
PE1206	1.82±0.15	3.53±0.15	8.00±0.30	1.75±0.10	3.50±0.10	4.00±0.10	4.00±0.10	2.00±0.10	1.50±0.10	1.50±0.10	0.85±0.15
PE2010	3.00±0.15	5.60±0.15	12.10±0.30	1.75±0.10	5.50±0.10	4.00±0.10	4.00±0.10	2.00±0.10	1.50±0.10	1.50±0.10	0.80±0.15
PE2512	3.40±0.15	6.70±0.15	12.10±0.30	1.75±0.10	5.50±0.10	4.00±0.10	4.00±0.10	2.00±0.10	1.50±0.10	1.50±0.10	0.80±0.15
PE4527	7.50±0.15	12.0±0.15	24.00±0.30	1.75±0.10	11.50±0.10	4.00±0.10	8.00±0.10	2.00±0.10	1.50±0.10	1.50±0.10	0.90±0.15

REEL SPECIFICATION

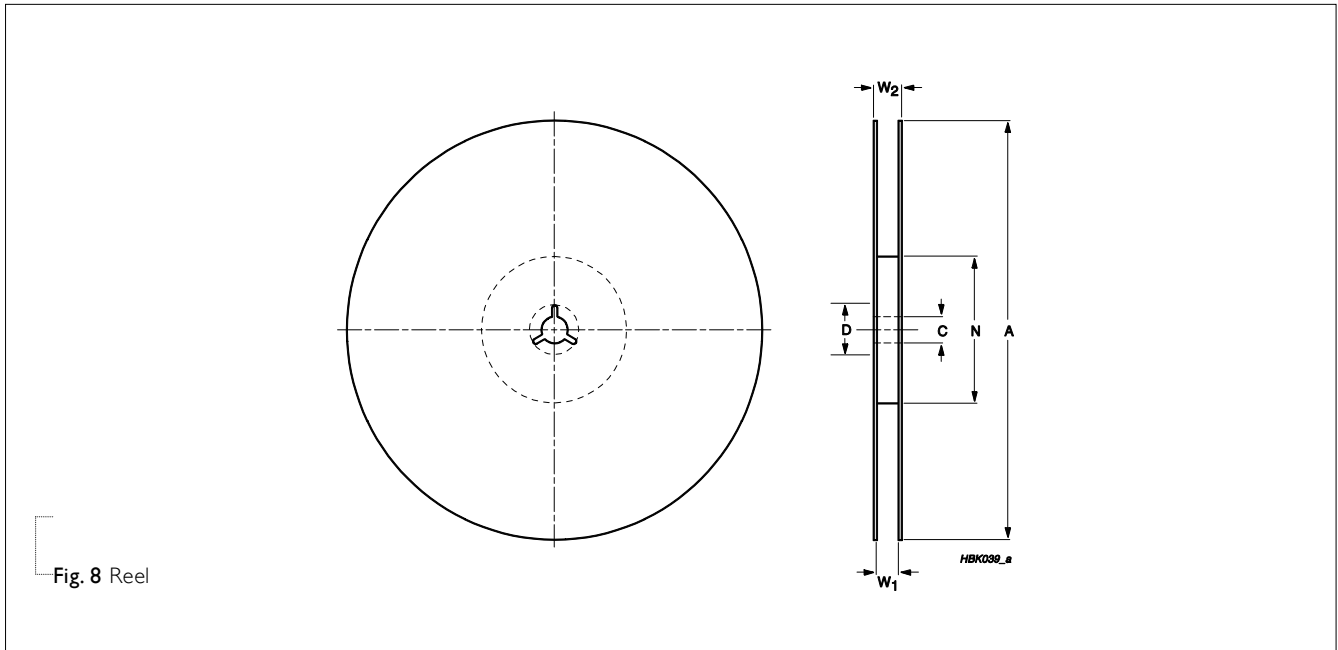

Fig. 8 Reel

Table 6 Dimensions of reel specification for relevant chip resistors size

SIZE	QUANTITY PER REEL	REEL SIZE			SYMBOL		Unit: mm				
		8 mm TAPE WIDE	12 mm TAPE WIDE	24 mm TAPE WIDE	A	N	C	D	W ₁	W ₂ MAX.	
PE0603	5000	7" (Ø178 mm)	--	--	180.0+0/-3	60.0+1/-0	13.0±0.2	21.0±0.8	8.4 +1/-0	12.4	
PE0805	5000	7" (Ø178 mm)	--	--	180.0+0/-3	60.0+1/-0	13.0±0.2	21.0±0.8	8.4 +1/-0	12.4	
PE1206	4000	7" (Ø178 mm)	--	--	180.0+0/-3	60.0+1/-0	13.0±0.2	21.0±0.8	8.4 +1/-0	12.4	
PE2010	4000	-- (Ø178 mm)	7"	--	180.0+0/-3	60.0+1/-0	13.0±0.2	21.0±0.8	12.3 +1/-0	18.4	
PE2512	4000	-- (Ø178 mm)	7"	--	180.0+0/-3	60.0+1/-0	13.0±0.2	21.0±0.8	12.3 +1/-0	18.4	
PE4527	1000	--	--	7" (Ø178 mm)	180.0+0/-3	60.0+1/-0	13.0±0.2	21.0±0.8	24.0 +1/-0	26.5	

LEADER/TRAILER TAPE SPECIFICATION

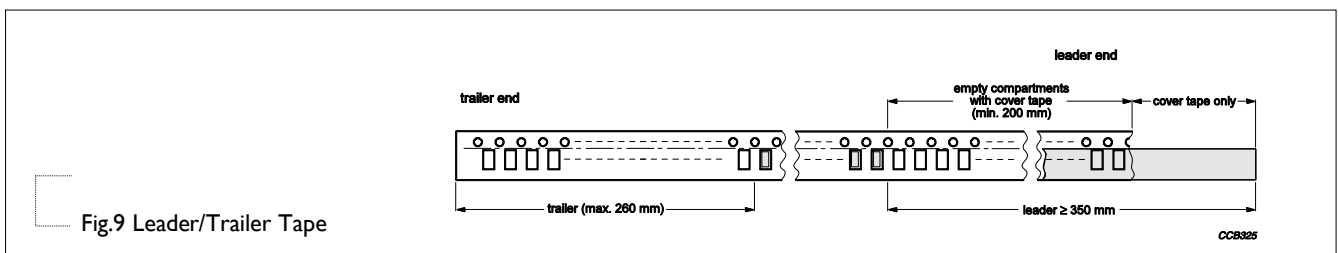

Fig.9 Leader/Trailer Tape

FOOTPRINT AND SOLDERING PROFILES

For recommended soldering profiles, please refer to data sheet “Chip resistors mounting”.

FOOTPRINT

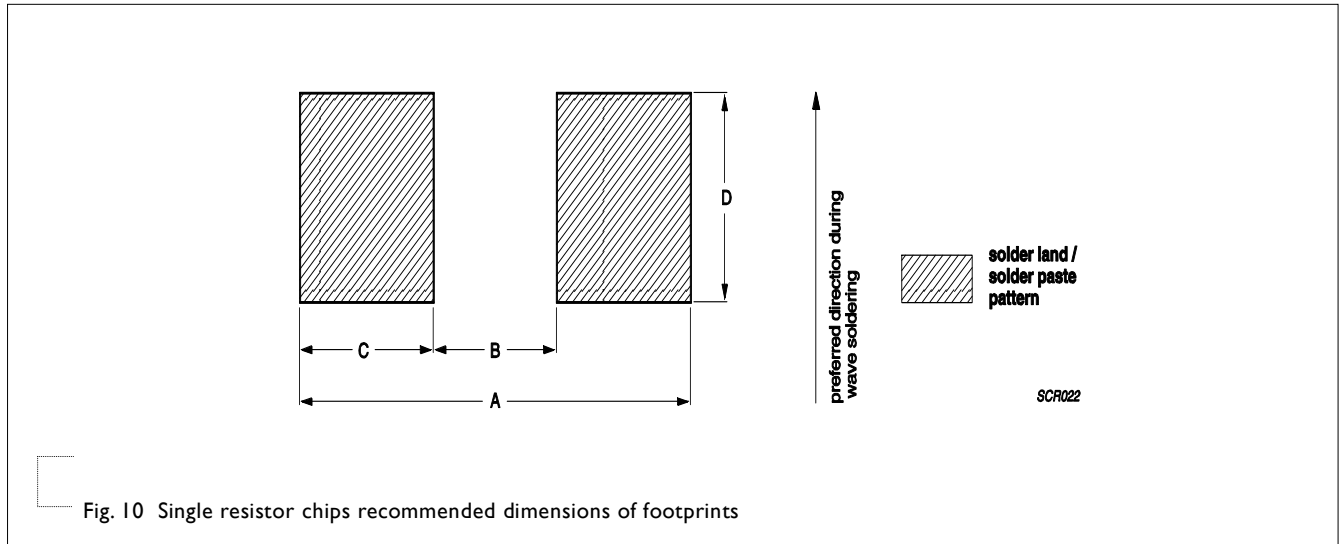

Table 7 Footprint dimensions

SIZE	RESISTANCE RANGE	Unit: mm			
		A	B	C	D
PE0603	5 mΩ ≤ R ≤ 100 mΩ	2.10	0.60	0.75	0.92
	4 mΩ	5.00	0.40	2.30	1.44
PE0805	5 mΩ	5.00	0.50	2.25	1.44
	6 mΩ	4.80	0.60	2.10	1.44
	7 mΩ ≤ R < 100 mΩ	5.00	0.80	2.10	1.44
PE1206	4 mΩ	6.20	0.50	2.85	1.84
	5 mΩ ≤ R ≤ 8 mΩ	6.20	0.60	2.80	1.84
PE2010	9 mΩ ≤ R ≤ 100 mΩ	6.20	1.20	2.50	1.84
	5 mΩ ≤ R ≤ 9 mΩ	8.00	1.40	3.30	2.88
PE2512	10 mΩ ≤ R ≤ 100 mΩ	8.00	2.70	2.65	2.88
	5 mΩ ≤ R ≤ 8 mΩ	9.30	1.60	3.85	3.57
PE4527	9 mΩ ≤ R < 100 mΩ	9.30	3.10	3.10	3.57
	100 mΩ	9.30	3.60	2.85	3.57
PE4527	5 mΩ	14.50	4.00	5.25	8.05
	6 mΩ ≤ R < 910 mΩ	14.50	4.40	5.05	8.05

TESTS AND REQUIREMENTS
Table 8 Test condition, procedure and requirements

TEST	TEST METHOD	PROCEDURE	REQUIREMENTS
Life/ Operational Life/ Endurance	MIL-STD-202G-method 108A	1,000 hours at 70±5 °C applied RCWV	±(1%+0.0005 Ω)
	IEC 60115-1 4.25.1	1.5 hours on, 0.5 hour off, still air required	
	JIS C 5202-7.10		
High Temperature Exposure/ Endurance at Upper Category Temperature	MIL-STD-202G-method 108A	1,000 hours at maximum operating temperature	±(1%+0.0005 Ω)
	IEC 60115-1 4.25.3	depending on specification, unpowered	
	JIS C 5202-7.11	No direct impingement of forced air to the parts Tolerances: 155±3 °C	
Moisture Resistance	MIL-STD-202G-method 106F	Each temperature / humidity cycle is defined at 8 hours (method 106F), 3 cycles / 24 hours for 10d with 25 °C / 65 °C 95% R.H, without steps 7a & 7b, unpowered Parts mounted on test-boards, without condensation on parts Measurement at 24±2 hours after test conclusion	±(0.5%+0.0005 Ω)
	IEC 60115-1 4.24.2		
Thermal Shock	MIL-STD-202G-method 107G	-55/+155 °C Note: Number of cycles required is 300. Maximum transfer time is 20 seconds. Dwell time is 15 minutes. Air – Air	±(0.5%+0.0005 Ω)
Short Time Overload	MIL-R-55342D-para 4.7.5	5 times of rated power for 5 seconds at room temperature	±(0.5%+0.0005 Ω) No visible damage
	IEC60115-1 4.13		
Board Flex/ Bending	IEC60115-1 4.33	Device mounted on PCB test board as described, only 1 board bending required	±(1%+0.0005 Ω) No visible damage
		Bending for 0603/0805: 3 mm	
		1206/2512/4520/4527: 2 mm Holding time: minimum 60 seconds	
Humidity	IEC 60115-1 4.21	Steady state for 1000 hours at 40 °C / 95% R.H. RCWV applied for 1.5 hours on and 0.5 hour off	±(1%+0.0005 Ω)

TEST	TEST METHOD	PROCEDURE	REQUIREMENTS
Solderability - Wetting	IPC/JEDECJ-STD-002B test B	Electrical Test not required	Well tinned ($\geq 95\%$ covered)
	IEC 60068-2-58	Magnification 50X SMD conditions: 1 st step: method B, aging 4 hours at 155 °C dry heat 2 nd step: leadfree solder bath at 245±3 °C Dipping time: 3±0.5 seconds	No visible damage
- Leaching	IPC/JEDECJ-STD-002B test D IEC 60068-2-58	Leadfree solder, 260 °C, 30 seconds immersion time	No visible damage
- Resistance to Soldering Heat	MIL-STD-202G-method 210F	Condition B, no pre-heat of samples	±(0.5%+0.0005 Ω)
	IEC 60068-2-58	Leadfree solder, 260 °C, 10 seconds immersion time Procedure 2 for SMD: devices fluxed and cleaned with isopropanol	No visible damage



REVISION HISTORY

REVISION	DATE	CHANGE NOTIFICATION	DESCRIPTION
Version 2	Aug. 22, 2014	-	- extend resistance value - update dimensions - remove PE4520 - remove 2% and 0.5% tol.
Version 1	Sep. 14, 2013	-	- Update the PE2512 resistance value.
Version 0	May. 28, 2012	-	- New datasheet for current sensor - low TCR PE series sizes of 0603/0805/1206/2010/2512/4520/4527, 0.5%, 1%, 2% and 5% with lead-free terminations







“Yageo reserves all the rights for revising the content of this datasheet without further notification, as long as the products itself are unchanged. Any product change will be announced by PCN.”

Looking for pricing, stock, or lifecycle information?

Click below to explore more details on WIN SOURCE:

-  [View PE2512FKM7W0R05Z on WIN SOURCE](#)
-  [Yageo Information](#)

Optimize Your Supply Chain with WIN SOURCE Solutions

-  Global Sourcing Solution
-  Obsolete Management
-  Cost Control Management
-  Shortage Management
-  Alternative Solution
-  Excess Inventory Management