



**THE DATASHEET OF
CDBHM160L-HF**



CDBHM120L-HF Thru. CDBHM1100L-HF

Reverse Voltage: 20 to 100 Volts

Forward Current: 1.0 Amp

RoHS Device

Halogen Free

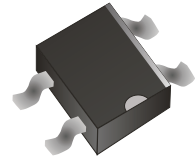

Features

- High surge forward current capability.
- Low Forward voltage drop.
- General purpose 1 phase Bridge rectifier applications
- UL recognized file # E230084

Mechanical data

- Case: molded plastic
- Epoxy: UL 94V-0 rate flame retardant.
- Lead: solder plated
- Polarity: As marked
- Weight: 0.125 gram(approx)

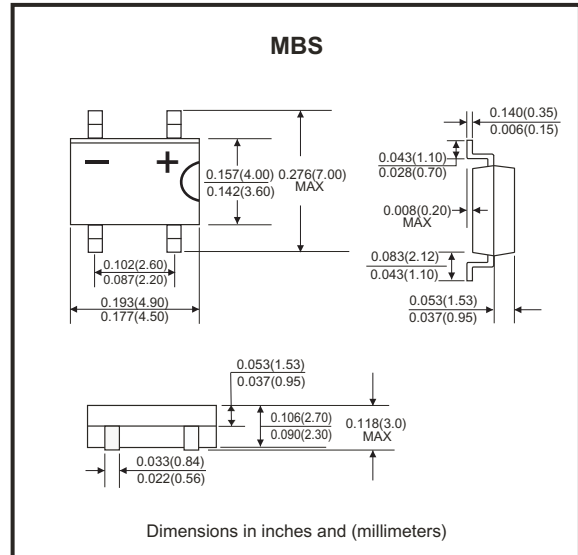

Maximum Ratings and Electrical Characteristics

Rating at 25°C ambient temperature unless otherwise specified.
Single phase, half wave, 60Hz resistive or inductive load.
For capacitive load, derate current by 20%

Parameter	Symbol	Conditions	CDBHM-HF					Units
			120L	140L	160L	180L	1100L	
Max. Repetitive peak reverse voltage	V_{RRM}		20	40	60	80	100	V
Max. DC blocking voltage	V_{DC}		20	40	60	80	100	V
Max. RMS voltage	V_{RMS}		14	28	42	56	70	V
Average rectified output current @60Hz sine wave, R-load, $T_A=25^\circ\text{C}$	I_o	On alumina substrate	1.0					A
		On glass-epoxi substrate	0.8					
Peak forward surge current, 8.3ms single half sine-wave superimposed on rated load (JEDEC method)	I_{FSM}		40					A
Max. Peak forward voltage	V_{FM}	$I_{FM}=0.5A$	0.55	0.65	0.85			V
Max. Peak reverse current	I_{RRM}	$V_{RM}=V_{RRM}$	0.5					mA
Max. Current Squared Time	I^2t	$1ms \leq t < 8.3ms$ $T_A=25^\circ\text{C}$	6.6					A^2S
Max. Thermal resistance	$R_{\theta JA}^{(1)}$	On alumina substrate	76					$^\circ\text{C/W}$
		On glass-epoxi substrate	134					
	$R_{\theta JL}$	Between junction and lead	20					
Operating temperature range	T_J		-55 to +150					$^\circ\text{C}$
Storage temperature range	T_{STG}		-55 to +150					$^\circ\text{C}$

Notes: 1. Between junction and ambient

Company reserves the right to improve product design , functions and reliability without notice.

REV: D

Rating and Characteristics Curves (CDBHM120L-HF Thru. CDBHM1100L-HF)

Fig.1 - Forward Current Derating Curve

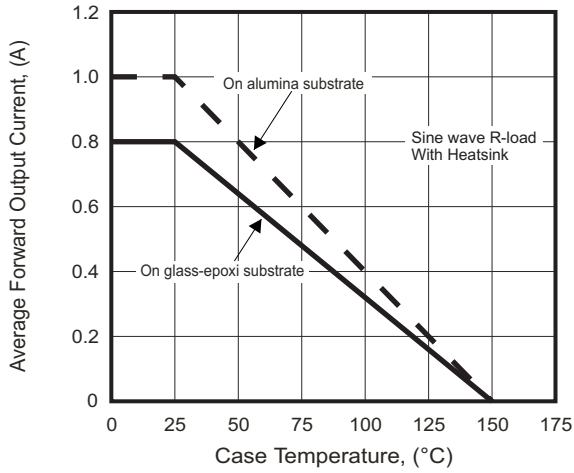

Fig.2 - Typical Forward Characteristics

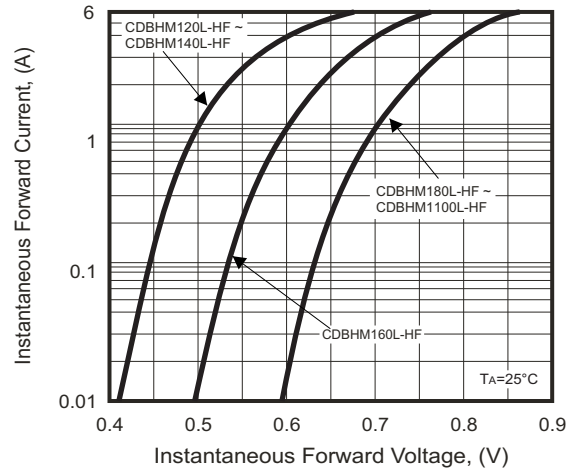

Fig.3 - Maximum Non-Repetitive Surge Current

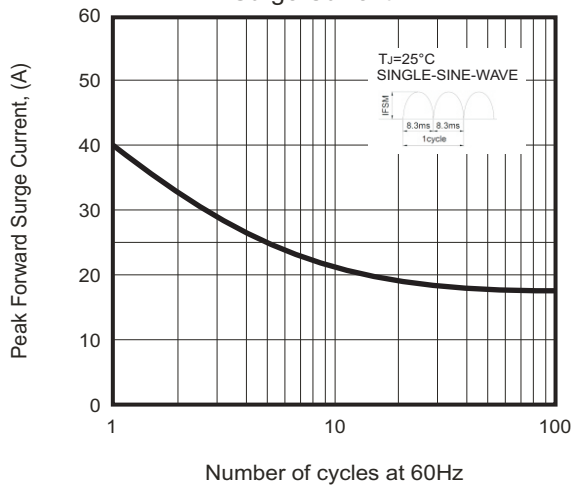
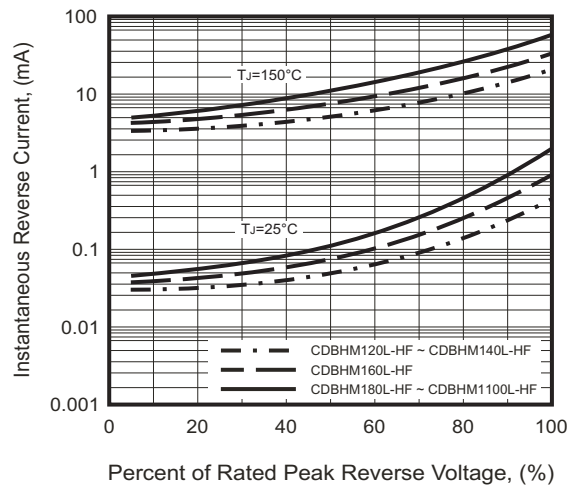
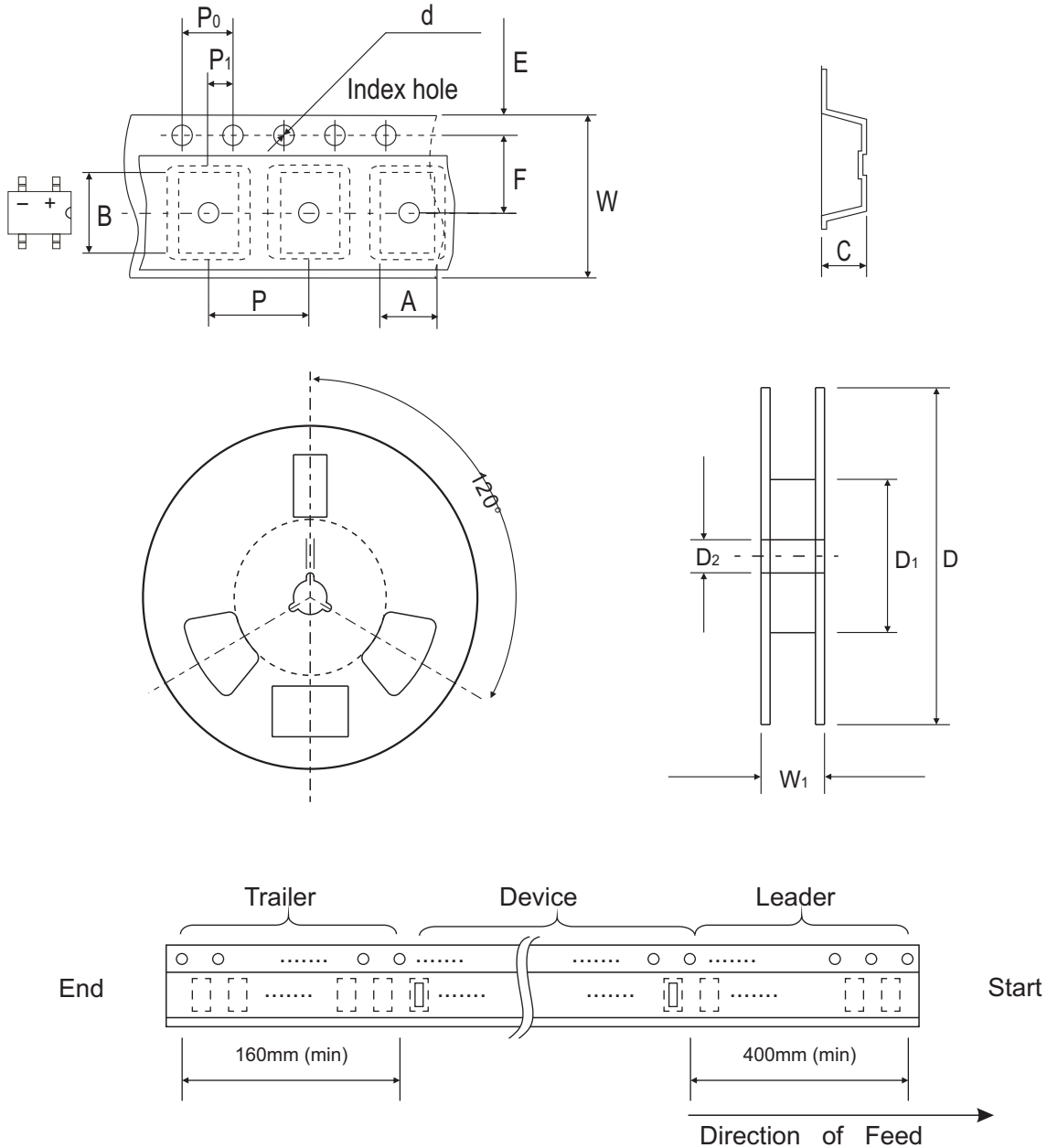

Fig.4 - Typical Reverse Characteristics



Reel Taping Specification



MBS	SYMBOL	A	B	C	d	D	D1	D2
	(mm)	5.00 ± 0.10	7.24 ± 0.10	2.95 ± 0.10	1.55 ± 0.05	330.0 ± 2.00	50.0 Min.	13.0 ± 0.50
	(inch)	0.197 ± 0.004	0.285 ± 0.004	0.116 ± 0.004	0.061 ± 0.002	13.00 ± 0.079	1.969 Min.	0.512 ± 0.020

MBS	SYMBOL	E	F	P	P0	P1	W	W1
	(mm)	1.75 ± 0.10	5.50 ± 0.05	8.00 ± 0.10	4.00 ± 0.10	2.00 ± 0.10	12.00 ± 0.30	18.70 Max.
	(inch)	0.069 ± 0.004	0.217 ± 0.002	0.315 ± 0.004	0.157 ± 0.004	0.079 ± 0.004	0.472 ± 0.012	0.736 Max.

Company reserves the right to improve product design, functions and reliability without notice.

Marking Code

Part Number	Marking Code
CDBHM120L-HF	MBSK12SE
CDBHM140L-HF	MBSK14SE
CDBHM160L-HF	MBSK16SE
CDBHM180L-HF	MBSK18SE
CDBHM1100L-HF	MBSK110SE

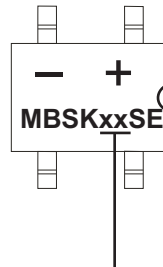

xx/xxx = Product type marking code

Suggested PAD Layout

SIZE	MBS	
	(mm)	(inch)
A	1.20	0.047
B	1.84	0.072
C	2.40	0.094
D	6.00	0.236

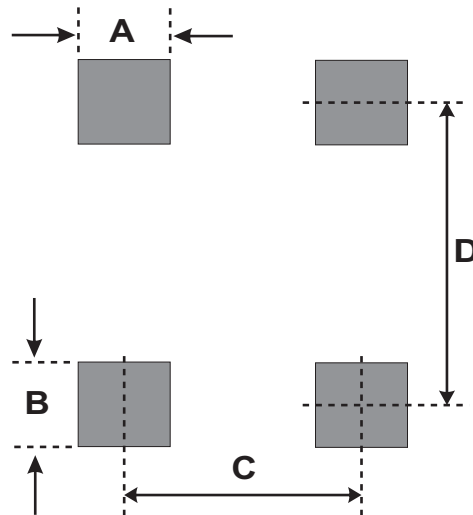

Standard Packaging

Case Type	REEL PACK	
	REEL (pcs)	Reel Size (inch)
MBS	2,500	13

Looking for pricing, stock, or lifecycle information?

Click below to explore more details on WIN SOURCE:

- [View CDBHM160L-HF on WIN SOURCE](#)
- [Comchip Technology Information](#)

Optimize Your Supply Chain with WIN SOURCE Solutions

- ✓ Global Sourcing Solution
- ✓ Obsolete Management
- ✓ Cost Control Management
- ✓ Shortage Management
- ✓ Alternative Solution
- ✓ Excess Inventory Management