



**THE DATASHEET OF
HV733ATTE3003F**





features

- Superior to RK73 series in maximum working voltage
- Products with lead-free terminations meet EU RoHS requirements. EU RoHS regulation is not intended for Pb-glass contained in electrode, resistor element and glass.

dimensions and construction

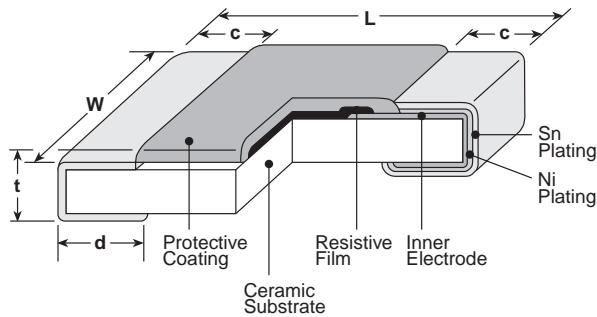

Type (Inch Size Code)	Dimensions inches (mm)				
	L	W	c	d	t
1J (0603)	.063±.008 (1.6±0.2)	.031±.004 (0.8±0.1)	.012±.004 (0.3±0.1)	.012±.004 (0.3±0.1)	.018±.004 (0.45±0.1)
2A (0805)	.079±.008 (2.0±0.2)	.049±.004 (1.25±0.1)	.016±.008 (0.4±0.2)	.012 ^{+0.008} _{-0.004} (0.3 ^{+0.2} _{-0.1})	.02±.004 (0.5±0.1)
2B (1206)	.126±.008 (3.2±0.2)	.063±.008 (1.6±0.2)	.02±.012 (0.5±0.3)	.016 ^{+0.008} _{-0.004} (0.4 ^{+0.2} _{-0.1})	.024±.004 (0.6±0.1)
2H (2010)	.197±.008 (5.0±0.2)	.098±.008 (2.5±0.2)	.02±.012 (0.5±0.3)	.016 ^{+0.008} _{-0.004} (0.4 ^{+0.2} _{-0.1})	.024±.004 (0.6±0.1)
3A (2512)	.248±.008 (6.3±0.2)	.122±.008 (3.1±0.2)	.02±.012 (0.5±0.3)	.016 ^{+0.008} _{-0.004} (0.4 ^{+0.2} _{-0.1})	.024±.004 (0.6±0.1)

Derating Curve

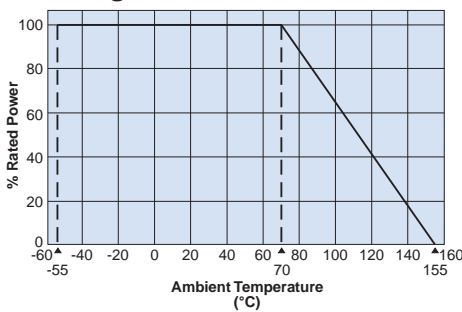

For resistors operated at an ambient temperature of 70°C or above, a power rating shall be derated in accordance with the above derating curve.

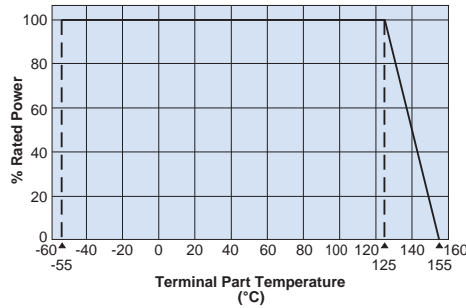

For resistors operated at a terminal part temperature of described for each size or above, a power rating shall be derated in accordance with the above derating curve.

Please refer to "Introduction of the derating curve based on the terminal part temperature" in the beginning of our catalog before use.

ordering information

HV73	2B	T	TD	1004	F
Type	Size	Termination Material	Packaging	Nominal Resistance	Resistance Tolerance
	1J: 0.1W 2A: 0.25W 2B: 0.25W 2H: 0.5W 3A: 1W	T: Sn	TD: 0603, 0805, 1206: 7" 4mm pitch punched paper TE: 2010 & 2512: 7" embossed plastic For further information on packaging, please refer to Appendix A	±0.5%, ±1%: 3 significant figures + 1 multiplier ±2%, ±5%: 2 significant figures + 1 multiplier	D: ±0.5% F: ±1% G: ±2% J: ±5%

applications and ratings

Part Designation	Power Rating @ 70°C	Rated Ambient Temp.	Rated Terminal Part Temp.	T.C.R. (ppm/°C) Max.	Resistance Range (Ω)				Absolute Maximum Working Voltage	Maximum Overload Voltage (D.C.)*	Operating Temp. Range
					E-24/E-96 (D±0.5%)	E-24/E-96 (F±1%)	E-24 (G±2%)	E-24 (J±5%)			
1J	0.1W	70°C	125°C	±100**	—	10k - 10M	10k - 10M	10k - 10M	350V	500V*	-55°C to +155°C
2A	0.25W	70°C	125°C	±100	100k - 1M	100k - 10M	100k - 10M	100k - 10M	400V	800V*	
				±200	—	—	—	11M - 51M			
2B	0.25W	70°C	125°C	±100	100k - 1M	100k - 10M	100k - 10M	100k - 10M	800V	1000V*	
				±200	—	—	—	11M - 51M			
2H	0.5W	70°C	125°C	±100	100k - 1M	100k - 10M	100k - 10M	100k - 10M	2000V (D.C.)	3000V*	
				±200	—	10.2M - 51M	11M - 51M	11M - 51M			
				±300	—	51.1M - 100M	56M - 100M	56M - 100M			
3A	1W	70°C	125°C	±100	43k - 1M	43k - 10M	43k - 10M	43k - 10M	3000V (D.C.)	4000V*	
				±200	—	10.2M - 20M	11M - 20M	11M - 51M			

* Max. overload voltage is specified by D.C. voltage

** Cold T.C.R. (-55°C ~ +25°C) of 1.02MΩ ~ 10MΩ is +200x10⁻⁶/K

If any questions should arise whether to use the "Rated Ambient Temperature" or the "Rated Terminal Part Temperature," please give priority to the "Rated Terminal Part Temperature." Prior to use and for more details refer to "Introduction of the derating curves on the terminal part temperature" in the beginning of the catalog.

Rated voltage = $\sqrt{\text{Power rating} \times \text{resistance value}}$ or max. working voltage, whichever is lower

environmental applications

Temperature Rise

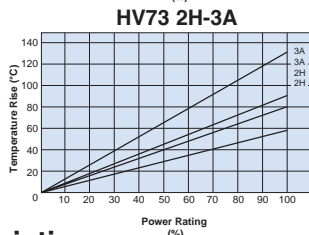
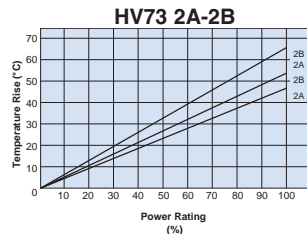

Regarding the temperature rise, the value of the temperature varies per conditions and board for use since the temperature is measured under our measuring conditions.

One-Pulse Limiting Electric Power

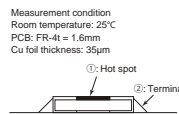
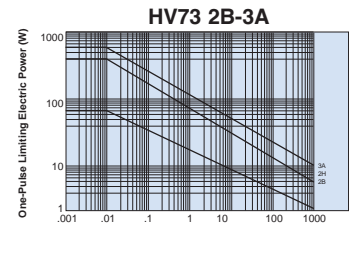
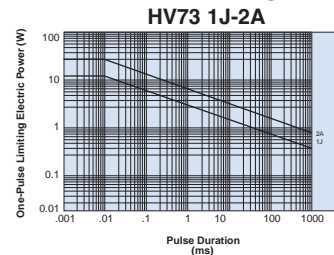

Measurement condition
Room temperature: 25°C
PCB: FR-4t = 1.6mm
Cu foil thickness: 35µm

The maximum applicable voltage is equal to the max. overload voltage. Please ask us about the resistance characteristic of continuous applied pulse. The pulse endurance values are not assured values, so be sure to check the products on actual equipment when you use them.

Performance Characteristics

Parameter	Requirement Δ R ±(%+0.1Ω)		Test Method
	Limit	Typical	
Resistance	Within regulated tolerance	—	25°C
T.C.R.	Within specified T.C.R.	—	+25°C/-55°C and +25°C/+125°C
Overload (Short time)	±2%	±0.5%	Rated Voltage (D.C.) x 2.5 for 5 seconds
Resistance to Solder Heat	±1%	±0.5%	260°C ± 5°C, 10 seconds ± 1 second
Rapid Change of Temperature	±0.5%: (10kΩ ≤ R ≤ 10MΩ) ±1%: (10MΩ ≤ R ≤ 100MΩ)	±0.3%: (10kΩ ≤ R ≤ 10MΩ) ±0.5%: (10MΩ ≤ R ≤ 100MΩ)	-55°C (30 minutes), +125°C (30 minutes), 100 cycles
Moisture Resistance	±2%	±0.75%	40°C ± 2°C, 90%-95% RH, 1000 hours, 1.5 hr ON, 0.5 hr OFF cycle
Endurance at 70°C	±2%	±0.75%	70°C ± 2°C, 1000 hours, 1.5 hr ON, 0.5 hr OFF cycle
High Temperature Exposure	±2%	±0.3%	+155°C, 1000 hours

Additional environmental applications can also be found at www.koaspeer.com

Specifications given herein may be changed at any time without prior notice. Please confirm technical specifications before you order and/or use.

5/17/23

Looking for pricing, stock, or lifecycle information?

Click below to explore more details on WIN SOURCE:

 [View HV733ATTE3003F on WIN SOURCE](#)

 [KOA Speer Information](#)

Optimize Your Supply Chain with WIN SOURCE Solutions

-  Global Sourcing Solution
-  Obsolete Management
-  Cost Control Management
-  Shortage Management
-  Alternative Solution
-  Excess Inventory Management