



THE DATASHEET OF MCR18EZHFLR390



Low Ohmic Thick Film Chip Resistors

MCR Series < Automotive >

●Features

- 1) Very-low ohmic resistance from 47mΩ is in lineup by thick-film resistive element.
- 2) ROHM resistors have obtained ISO9001 / ISO / TS16949 certification.
- 3) "Automotive" product is AEC-Q200 compliant.



Part No.	Size		Type Code		Packing Specification	Quantity / Reel
	(mm)	(inch)	GENERAL PURPOSE	AUTOMOTIVE *Corresponds to AEC-Q200		
MCR006	0603	0201	YRT	YZP	Paper tape (2mm Pitch)	15,000
MCR01	1005	0402	MRT	MZP		10,000
MCR03	1608	0603	ERT	EZP	Paper tape (4mm Pitch)	5,000
MCR10	2012	0805	EZH			
MCR18	3216	1206	EZH			
MCR25	3225	1210	JZH		Embossed tape (4mm Pitch)	4,000
MCR50	5025	2010	JZH			
MCR100	6432	2512	JZH			

*Please contact us for status of AEC-Q200 on "General purpose" products.

●Part Number Description

Part No.	Size (mm [inch])	Type Code	Resistance Tolerance	Special part code	Nominal Resistance
MCR (Micro chip resistors)	006 (0603 [0201]) 01 (1005 [0402]) 03 (1608 [0603]) 10 (2012 [0805]) 18 (3216 [1206]) 25 (3225 [1210]) 50 (5025 [2010]) 100 (6432 [2512])	EZH	F (±1%) J (±5%)	L 0.1 to 9.1Ω (±1%) S 0.047 to 0.091Ω	Resistance code, 3 or 4 digits. Resistance tolerance + Resistance code Special P / N FL, FS, JS : 4 digits JL : 3 digits Ex.) 0.047Ω = R047 (±1%, ±5%) 9.1Ω = 9R10 (±1%) 9R1 (±5%)

●Products List

Part No.	Type Code	Rated Power (70°C) (W)	Limiting Element Voltage (V)	Maximum Overload Voltage (V)	Temperature Coefficient (ppm / °C)	Resistance Tolerance (%)	Resistance Range	Series	Operating Temperature Range (°C)
MCR006	YZP	0.05	0.67	1.34	±600 / -200	F(±1%)	1.0Ω to 9.1Ω	E24	-55 to +125
MCR01	MZP	0.063	0.76	1.52	±400	F(±1%)	1.0Ω to 9.1Ω		-55 to +155
MCR03	EZP	0.1	0.95	1.90	±400	F(±1%)	1.0Ω to 9.1Ω		
MCR10	EZH	0.25	1.51	3.02	500±300 400±200 ±250	J(±5%)	0.047Ω to 0.091Ω 0.1Ω to 0.13Ω 0.15Ω to 0.91Ω		
					500±300 400±200 ±250	F(±1%)	0.047Ω to 0.091Ω 0.1Ω to 0.13Ω 0.15Ω to 9.1Ω		
MCR18	EZH	0.25	1.51	3.02	500±300 400±200 ±250	J(±5%)	0.047Ω to 0.091Ω 0.1Ω to 0.13Ω 0.15Ω to 0.91Ω		
					500±300 400±200 ±250	F(±1%)	0.047Ω to 0.091Ω 0.1Ω to 0.13Ω 0.15Ω to 9.1Ω		
MCR25	JZH	0.5	2.13	4.26	300±300 ±200	J(±5%)	0.047Ω to 0.091Ω 0.1Ω to 0.91Ω		
					300±300 ±200	F(±1%)	0.047Ω to 0.091Ω 0.1Ω to 9.1Ω		
MCR50	JZH	0.5	2.13	4.26	500±300 400±200 ±250	J(±5%)	0.047Ω to 0.091Ω 0.1Ω to 0.13Ω 0.15Ω to 0.91Ω		
					500±300 400±200 ±250	F(±1%)	0.047Ω to 0.091Ω 0.1Ω to 0.13Ω 0.15Ω to 9.1Ω		
MCR100	JZH	1	3.01	6.02	500±300 400±200 ±250	J(±5%)	0.047Ω to 0.091Ω 0.1Ω to 0.13Ω 0.15Ω to 0.91Ω		
					500±300 400±200 ±250	F(±1%)	0.047Ω to 0.091Ω 0.1Ω to 0.13Ω 0.15Ω to 9.1Ω		

*Design and specifications are subject to change without notice. Carefully check the specification sheet supplied with the product before using or ordering it.

●Chip Resistor Dimensions and Markings



<Marking method>

There are three or four digits used for the calculation number according to IEC code and "R" is used for the decimal point.

(Unit : mm)

Part No.	Type Code	(mm)	(inch)	L	W	t	a	b	Marking existence
MCR006	YZP	0603	0201	0.6±0.03	0.3±0.03	0.23±0.03	0.1±0.05	0.15±0.05	No
MCR01	MZP	1005	0402	1.0±0.05	0.5±0.05	0.35±0.05	0.2±0.1	0.25 ^{+0.05} _{-0.1}	No
MCR03	EZP	1608	0603	1.6±0.1	0.8±0.1	0.45±0.1	0.3±0.2	0.3±0.2	3 digits
MCR10	EZH	2012	0805	2.0±0.1	1.25±0.1	0.55±0.1	0.4±0.2	0.4±0.2	Yes
MCR18	EZH	3216	1206	3.2±0.15	1.6±0.15	0.55±0.1	0.5±0.25	0.5±0.25	Yes
MCR25	JZH	3225	1210	3.2±0.15	2.5±0.15	0.55±0.15	0.5±0.25	0.5±0.25	Yes
MCR50	JZH	5025	2010	5.0±0.15	2.5±0.15	0.55±0.15	0.6±0.25	0.6±0.25	Yes
MCR100	JZH	6432	2512	6.3±0.15	3.2±0.15	0.55±0.15	0.6±0.25	0.6±0.25	Yes

●Land pattern Example

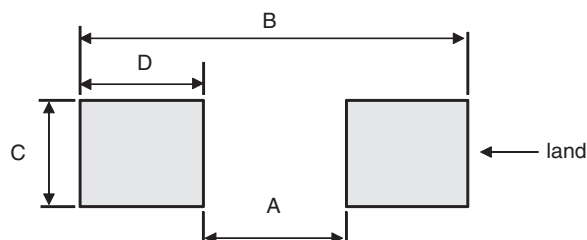

(Unit : mm)

Part No.	Type Code	A	B	C	D
MCR006	YZP	0.3	0.84	0.3	0.27
MCR01	MZP	0.5	1.3	0.5	0.4
MCR03	EZP	1.0	2.0	0.8	0.5
MCR10	EZH	1.2	2.6	1.15	0.7
MCR18	EZH	2.2	4.0	1.5	0.9
MCR25	JZH	2.2	4.0	2.3	0.9
MCR50	JZH	3.8	6.0	2.3	1.1
MCR100	JZH	5.1	8.1	3.0	1.5

●Derating Curve

When the ambient temperature exceeds 70°C, power dissipation must be adjusted according to the derating curves below.

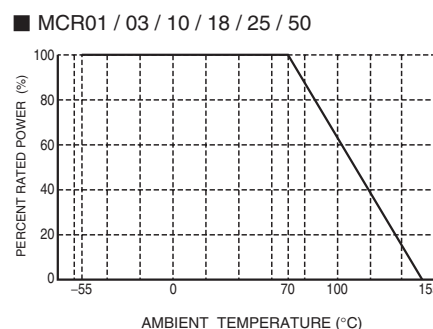
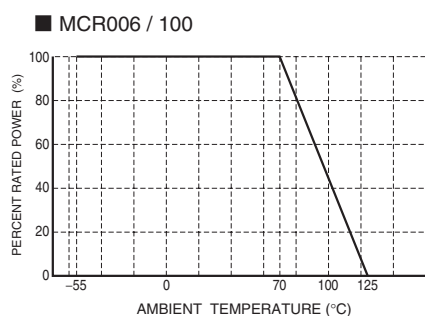

●Characteristics

Test Items	Guaranteed Value	Test Conditions
Resistance	See "Products List"	20°C
Variation of resistance with temperature	See "Products List"	Measurement : +20 / -55 / +20 / +125°C
Overload	± (2.0%+0.005Ω)	Rated voltage (current) ×2.5, 2s. Maximum overload voltage
Solderability	A new uniform coating of minimum of 95% of the surface being immersed and no soldering damage.	Rosin-Ethanol : 25% (weight) Soldering condition : 235±5°C Duration of immersion : 2.0±0.5s
Resistance to soldering heat	± (1.0%+0.05Ω) No remarkable abnormality on the appearance.	Soldering condition : 260±5°C Duration of immersion : 10±1s
Rapid change of temperature	± (1.0%+0.005Ω)	Test temp. -55°C to +125°C 100cycle (MCR006) -55°C to +125°C 5cycle (MCR01 / 03 / 10 / 18 / 25 / 50 / 100)
Damp heat, steady state	± (3.0%+0.005Ω)	40°C, 93%RH (Relative Humidity) Test time : 1,000h to 1,048h
Endurance at 70°C	± (3.0%+0.005Ω)	70°C Rated voltage (current) 1.5h : ON – 0.5h : OFF Test time : 1,000h to 1,048h
Endurance	± (3.0%+0.005Ω)	125°C (MCR006 / 100) 155°C (MCR01 / 03 / 10 / 18 / 25 / 50) Test time : 1,000h to 1,048h
Resistance to solvent	± (1.0%+0.005Ω) ※MCR006 only ± (0.5%+0.005Ω)	23±5°C, Immersion cleaning, 5±0.5min Solvent : 2-propanol
Bend strength of the end face plating	Without Open.	-

Compliance Standard(s) : IEC60115-8
JISC 5201-8

●Technical data

Parameter	Unit	MCR006 YZP	MCR01 MZP	MCR03 EZP	MCR10 EZH	MCR18 EZH	MCR25 JZH	MCR50 JZH	MCR100 JZH
Insulation resistance	MΩ	1000	1000	1000	1000	1000	1000	1000	1000
Weight	mg/pc	0.15	0.565	2.03	5.00	9.78	16.5	25.8	42.0

●Tape Dimensions

■ Paper Tape

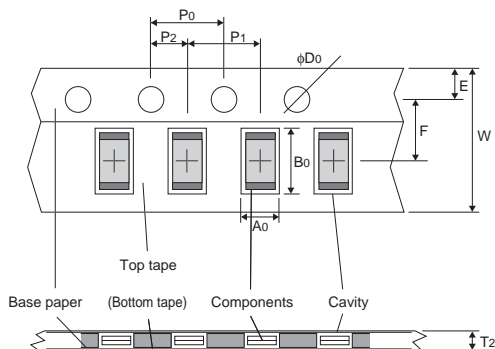

(Unit : mm)

Part No.	Type Code	W	F	E	A0	B0
MCR006	YZP	8.0±0.2	3.5±0.05	1.75±0.1	0.38±0.03	0.68±0.03
MCR01	MZP	8.0±0.3	3.5±0.05	1.75±0.1	0.7±0.1	1.2±0.1
MCR03	EZP	8.0±0.3	3.5±0.05	1.75±0.1	1.1±0.1	1.9±0.1
MCR10	EZH	8.0±0.3	3.5±0.05	1.75±0.1	1.65 ^{+0.2} _{-0.1}	2.4 ^{+0.2} _{-0.1}
MCR18	EZH	8.0±0.3	3.5±0.05	1.75±0.1	1.95 ^{+0.1} _{-0.05}	3.5 ^{+0.15} _{-0.05}

Part No.	Type Code	D0	P0	P1	P2	T2
MCR006	YZP	φ1.5 ^{+0.1} ₀	4.0±0.1	2.0±0.05	2.0±0.05	Max 0.5
MCR01	MZP	φ1.5 ^{+0.1} ₀	4.0±0.1	2.0±0.05	2.0±0.05	Max 1.1
MCR03	EZP	φ1.5 ^{+0.1} ₀	4.0±0.1	4.0±0.1	2.0±0.05	Max 1.1
MCR10	EZH	φ1.5 ^{+0.1} ₀	4.0±0.1	4.0±0.1	2.0±0.05	Max 1.1
MCR18	EZH	φ1.5 ^{+0.1} ₀	4.0±0.1	4.0±0.1	2.0±0.05	Max 1.1

■ Embossed Tape

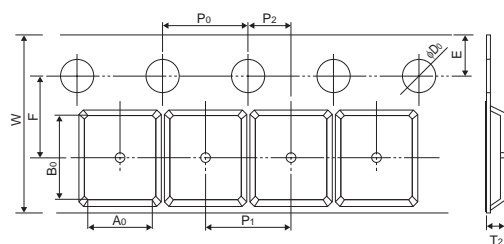

(Unit : mm)

Part No.	Type Code	W	F	E	A0	B0
MCR25	JZH	8.0±0.3	3.5±0.05	1.75±0.1	3.0±0.1	3.5±0.1
MCR50	JZH	12±0.3	5.5±0.05	1.75±0.1	3.4±0.2	5.6±0.2
MCR100	JZH	12±0.3	5.5±0.05	1.75±0.1	3.5±0.2	6.7±0.2

Part No.	Type Code	D0	P0	P1	P2	T2
MCR25	JZH	φ1.5 ^{+0.1} ₀	4.0±0.1	4.0±0.1	2.0±0.05	Max 1.1
MCR50	JZH	φ1.5 ^{+0.1} ₀	4.0±0.1	4.0±0.1	2.0±0.05	Max 1.1
MCR100	JZH	φ1.5 ^{+0.1} ₀	4.0±0.1	4.0±0.1	2.0±0.05	Max 1.1

●Reel Dimensions

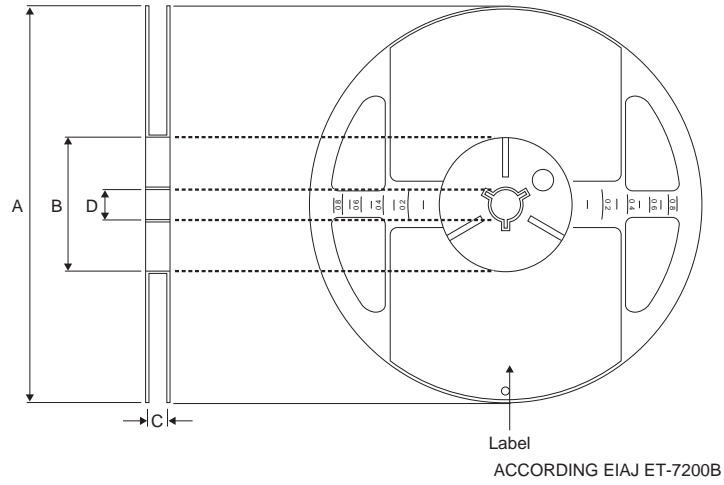

(Unit : mm)

Part No.	Type Code	A	B	C	D
MCR006	YZP	$\phi 180 \begin{matrix} 0 \\ -1.5 \end{matrix}$	$\phi 60 \begin{matrix} +1.0 \\ 0 \end{matrix}$	$9 \begin{matrix} +1.0 \\ 0 \end{matrix}$	$\phi 13 \pm 0.2$
MCR01	MZP				
MCR03	EZP				
MCR10	EZH				
MCR18	EZH			$13 \begin{matrix} +1.0 \\ 0 \end{matrix}$	
MCR25	JZH				
MCR50	JZH				
MCR100	JZH				

Notes

No copying or reproduction of this document, in part or in whole, is permitted without the consent of ROHM Co.,Ltd.

The content specified herein is subject to change for improvement without notice.

The content specified herein is for the purpose of introducing ROHM's products (hereinafter "Products"). If you wish to use any such Product, please be sure to refer to the specifications, which can be obtained from ROHM upon request.

Examples of application circuits, circuit constants and any other information contained herein illustrate the standard usage and operations of the Products. The peripheral conditions must be taken into account when designing circuits for mass production.

Great care was taken in ensuring the accuracy of the information specified in this document. However, should you incur any damage arising from any inaccuracy or misprint of such information, ROHM shall bear no responsibility for such damage.

The technical information specified herein is intended only to show the typical functions of and examples of application circuits for the Products. ROHM does not grant you, explicitly or implicitly, any license to use or exercise intellectual property or other rights held by ROHM and other parties. ROHM shall bear no responsibility whatsoever for any dispute arising from the use of such technical information.

The Products specified in this document are intended to be used with general-use electronic equipment or devices (such as audio visual equipment, office-automation equipment, communication devices, electronic appliances and amusement devices).

The Products specified in this document are not designed to be radiation tolerant.

While ROHM always makes efforts to enhance the quality and reliability of its Products, a Product may fail or malfunction for a variety of reasons.

Please be sure to implement in your equipment using the Products safety measures to guard against the possibility of physical injury, fire or any other damage caused in the event of the failure of any Product, such as derating, redundancy, fire control and fail-safe designs. ROHM shall bear no responsibility whatsoever for your use of any Product outside of the prescribed scope or not in accordance with the instruction manual.

The Products are not designed or manufactured to be used with any equipment, device or system which requires an extremely high level of reliability the failure or malfunction of which may result in a direct threat to human life or create a risk of human injury (such as a medical instrument, transportation equipment, aerospace machinery, nuclear-reactor controller, fuel-controller or other safety device). ROHM shall bear no responsibility in any way for use of any of the Products for the above special purposes. If a Product is intended to be used for any such special purpose, please contact a ROHM sales representative before purchasing.

If you intend to export or ship overseas any Product or technology specified herein that may be controlled under the Foreign Exchange and the Foreign Trade Law, you will be required to obtain a license or permit under the Law.



Thank you for your accessing to ROHM product informations.
More detail product informations and catalogs are available, please contact us.



ROHM Customer Support System

<http://www.rohm.com/contact/>



Looking for pricing, stock, or lifecycle information?

Click below to explore more details on WIN SOURCE:

-  [View MCR18EZHFLR390 on WIN SOURCE](#)
-  [Rohm Semiconductor](#) Information

Optimize Your Supply Chain with WIN SOURCE Solutions

-  Global Sourcing Solution
-  Obsolete Management
-  Cost Control Management
-  Shortage Management
-  Alternative Solution
-  Excess Inventory Management