



**THE DATASHEET OF
1N4148T-72**



Switching diode

1N4531 / 1N4148 / 1N4150 / 1N4448

* This product is available only outside of Japan.

● **Application**

High-speed switching

● **Features**

- 1) Glass sealed envelope. (MSD, GSD)
- 2) High speed.
- 3) High reliability.

● **Construction**

Silicon epitaxial planar

● **External dimensions (Units : mm)**

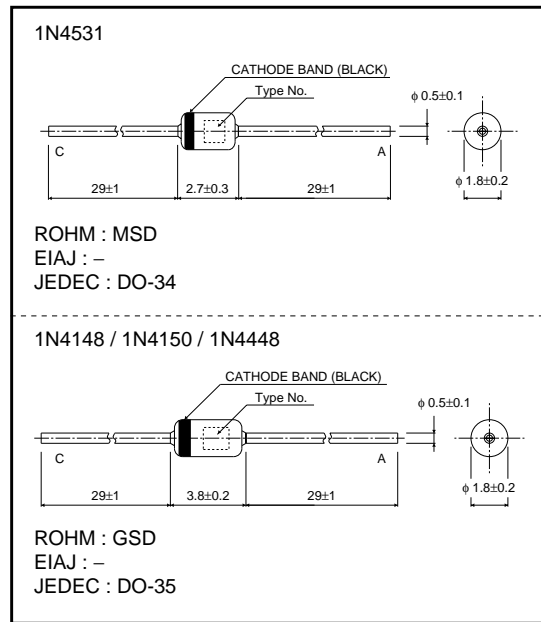

● **Absolute maximum ratings (Ta = 25°C)**

Type	V _{RM} (V)	V _R (V)	I _{FM} (mA)	I _O (mA)	I _F (mA)	I _{FSM} 1μs (A)	P (mW)	T _j (°C)	T _{opr} (°C)	T _{stg} (°C)
1N4531	100	75	450	150	200	2	500	200	-65~+200	-65~+200
1N4148	100	75	450	150	200	2	500	200	-65~+200	-65~+200
1N4150	50	50	600	200	250	4	500	200	-65~+200	-65~+200
1N4448	100	75	450	150	200	2	500	200	-65~+200	-65~+200

● **Electrical characteristics (Ta = 25°C)**

Type	V _F (V)											BV (V) Min.		I _R (μA) Max.		C _r (pF) V _R =0 f=1MHz	t _r (ns) V _R =6V I _F =10mA R _L =100Ω			
	@ 0.1mA	@ 0.25mA	@ 1mA	@ 2mA	@ 5mA	@ 10mA	@ 20mA	@ 30mA	@ 50mA	@ 100mA	@ 200mA	@ 250mA	@ 5μA	@ 100μA	@ 25°C			@ 150°C		
	V _R (V)		V _R (V)		V _R (V)		V _R (V)		V _R (V)		V _R (V)		V _R (V)		V _R (V)					
1N4531	/	/	/	/	/	1.0	/	/	/	/	/	/	75	100	0.025 5.0	20 75	50.0	20	4	4
1N4148	/	/	/	/	/	1.0	/	/	/	/	/	/	75	100	0.025 5.0	20 75	50.0	20	4	4
1N4150	/	/	0.54	/	/	0.66	/	/	0.76	0.82	0.87	/	-	50	0.1	50	100.0	50	2.5	4
1N4448	/	/	0.62	/	0.62	0.74	/	/	0.86	0.92	1.0	/	-	100	0.025 5.0	20 75	50.0	20	4	4

The upper figure is the minimum V_F and the lower figure is the maximum V_F value.

Diodes

●Electrical characteristic curves (Ta = 25°C)

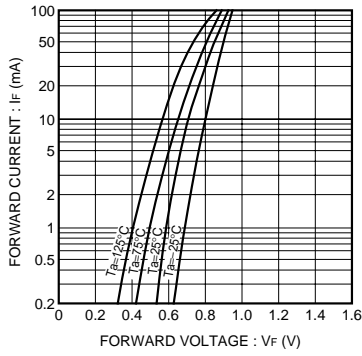

Fig. 1 Forward characteristics

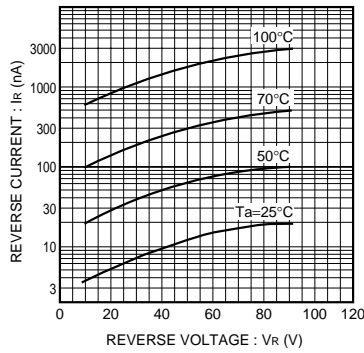

Fig. 2 Reverse characteristics

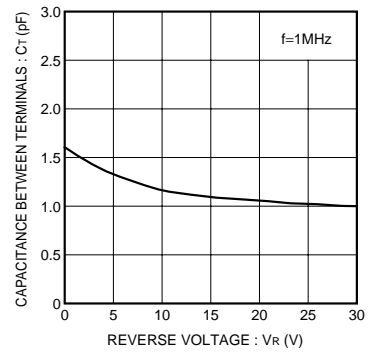

Fig. 3 Capacitance between terminals characteristics

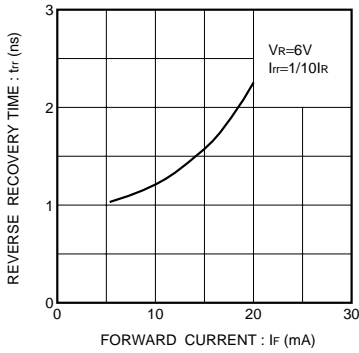

Fig. 4 Reverse recovery time characteristics

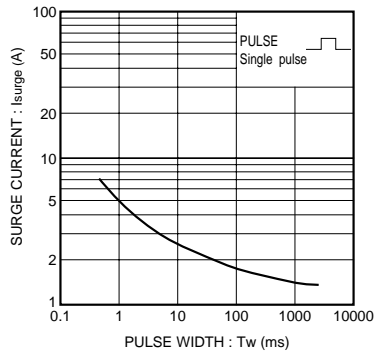

Fig. 5 Surge current characteristics

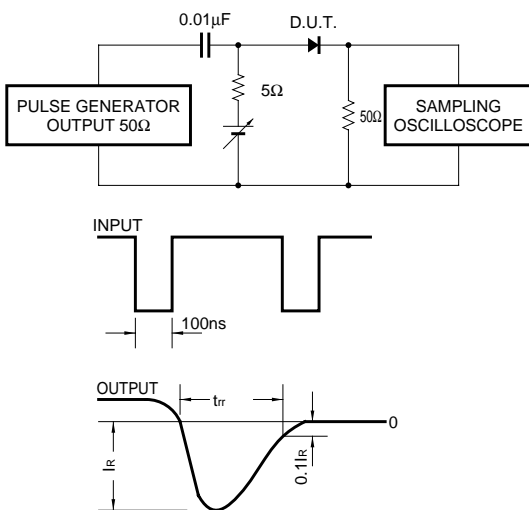

Fig. 6 Reverse recovery time (trr) measurement circuit

Looking for pricing, stock, or lifecycle information?

Click below to explore more details on WIN SOURCE:

- [View 1N4148T-72 on WIN SOURCE](#)
- [Rohm Semiconductor Information](#)

Optimize Your Supply Chain with WIN SOURCE Solutions

- ✓ Global Sourcing Solution
- ✓ Obsolete Management
- ✓ Cost Control Management
- ✓ Shortage Management
- ✓ Alternative Solution
- ✓ Excess Inventory Management