

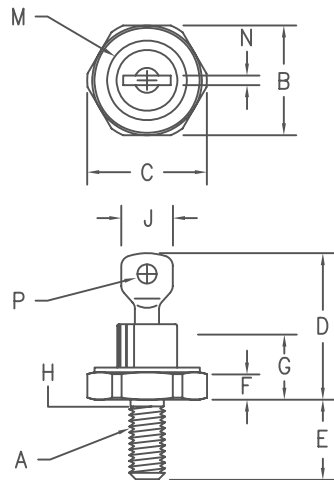

# Silicon Power Rectifier S/R20 Series



### Notes:

- 10-32 UNF3A
- Full threads within 2 1/2 threads
- Standard Polarity: Stud is Cathode  
Reverse Polarity: Stud is Anode

Dim.	Inches		Millimeter		Notes
	Minimum	Maximum	Minimum	Maximum	
A	---	---	---	---	1
B	.424	.437	10.77	11.10	
C	---	.505	---	12.82	
D	.600	.800	15.24	20.32	
E	.422	.453	10.72	11.50	
F	.075	.175	1.91	4.44	
G	---	.405	---	10.29	
H	.163	.189	4.15	4.80	2
J	---	.310	---	7.87	
M	---	.350	---	8.89	Dia
N	.020	.065	.510	1.65	
P	.070	.100	1.78	2.54	Dia

## D0203AA (D04)

Microsemi Catalog Number	JEDEC Numbers	Peak Reverse Voltage
1N1064	1N1341, A,B,C	1N1581 1N1612,A 1N2228,A 1N2491 50V
1N1065	1N1342, A,B,C	1N1582 1N1613,A 1N2492 100V
1N1066	1N1343, A,B,C	1N2493 150V
*S2020	1N1067 1N1344, A,B,C	1N1583 1N1614,A 1N2230,A 1N2493 200V
1N1068	1N1345, A,B,C	1N1584 1N2232,A 1N2494 300V
*S2040	1N1069 1N1346, A,B,C	1N1585 1N1615,A 1N2234,A 1N2495 400V
*S2060	1N1347, A,B,C	1N1586 1N2236,A 1N2496 500V
*S2080	1N1348, A,B,C	1N1587 1N1616,A 1N2238,A 1N2497 600V
*S20100		1N4458 1N2240,A 800V
*S20120		1N4459 1N2242,A 1000V
		1N2244,A 1200V

\*Change S to R in part number for Reverse Polarity  
For 1N types add an R suffix for Reverse Polarity

- Glass Passivated Die
- Low Forward Voltage
- 200A Surge Rating
- Glass to metal seal construction
- $V_{RRM}$  to 1200V
- Low cost Non-RoHS package

### Electrical Characteristics

Average forward current	IF(AV) 16 Amps	$T_C = 153^\circ\text{C}$ , half sine wave, $R_{\theta JC} = 2.5^\circ\text{C/W}$
Maximum surge current	IFSM 200 Amps	8.3ms, half sine, $T_J = 200^\circ\text{C}$
Max $I^2 t$ for fusing	$I^2 t$ 165 A <sup>2</sup> s	
Max peak forward voltage	V <sub>FM</sub> 1.3 Volts	I <sub>FM</sub> = 30A: $T_J = 25^\circ\text{C}$ *
Max peak reverse current	I <sub>RM</sub> 10 $\mu\text{A}$	$V_{RRM}, T_J = 25^\circ\text{C}$
Max peak reverse current	I <sub>RM</sub> 1.0 mA	$V_{RRM}, T_J = 150^\circ\text{C}$
Max Recommended Operating Frequency	10kHz	

\*Pulse test: Pulse width 300  $\mu\text{sec}$ . Duty cycle 2%

### Thermal and Mechanical Characteristics

Storage temperature range	$T_{STG}$	$-65^\circ\text{C}$ to $200^\circ\text{C}$
Operating junction temp range	$T_J$	$-65^\circ\text{C}$ to $200^\circ\text{C}$
Maximum thermal resistance	$R_{\theta JC}$	2.5 $^\circ\text{C/W}$ Junction to Case
Mounting torque		25-30 inch pounds
Weight		.16 ounces (5.0 grams) typical

# S/R20

Figure 1  
Typical Forward Characteristics

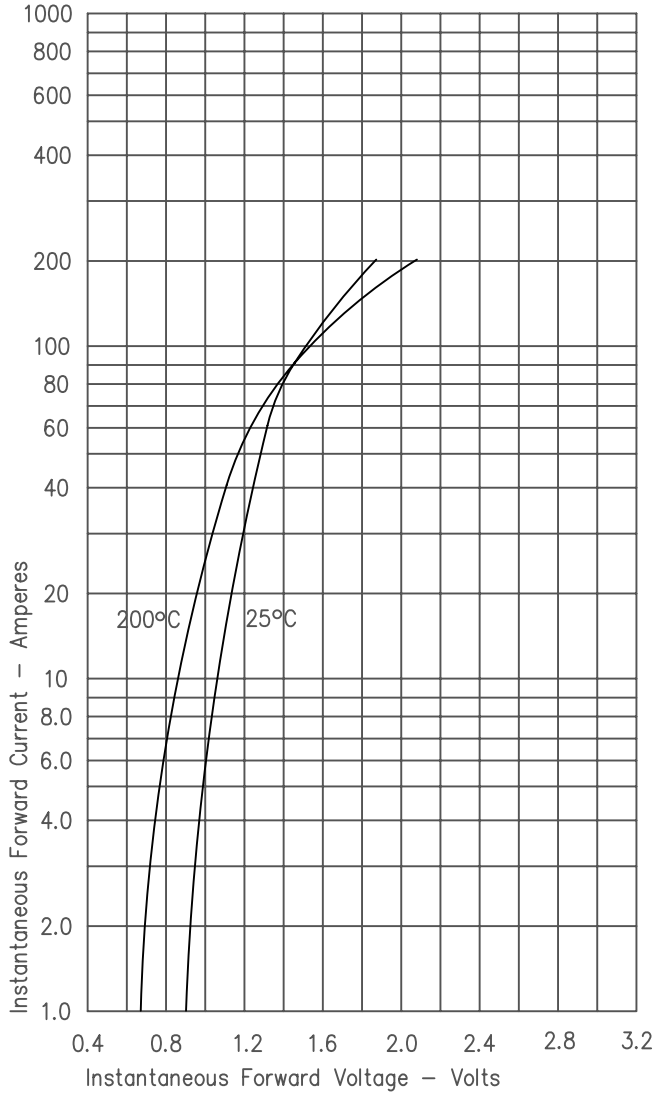

Figure 3  
Forward Current Derating

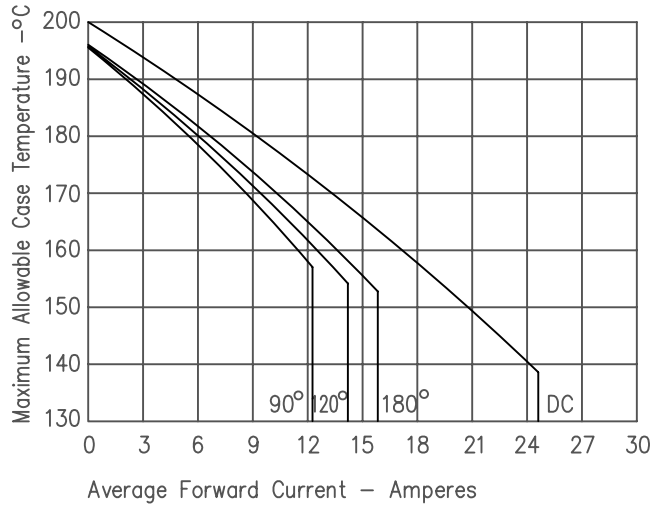

Figure 4  
Maximum Forward Power Dissipation

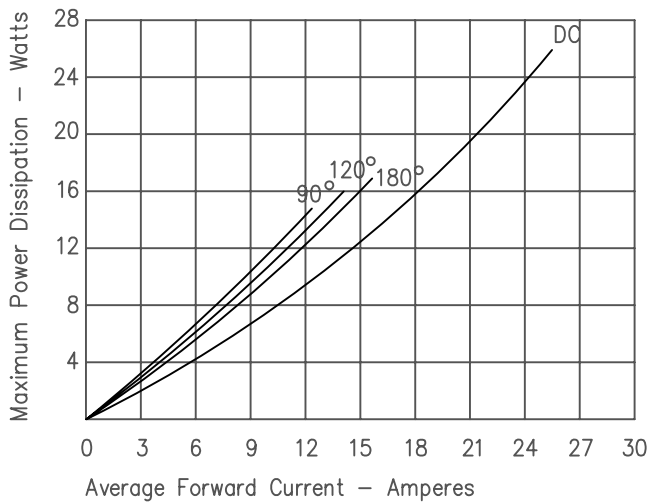

Figure 2  
Typical Reverse Characteristics

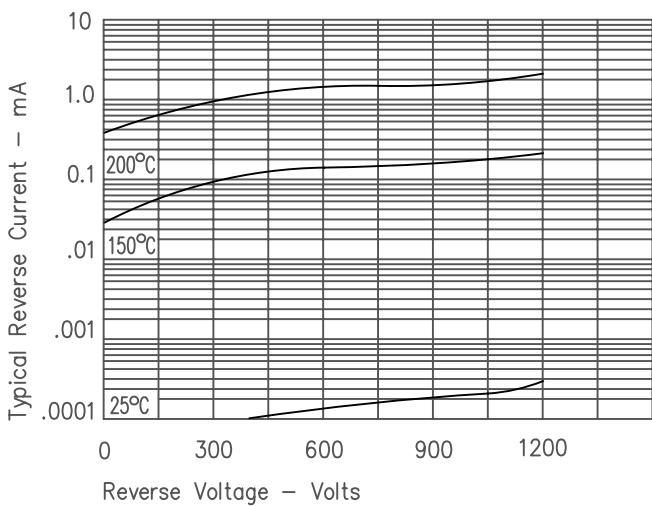
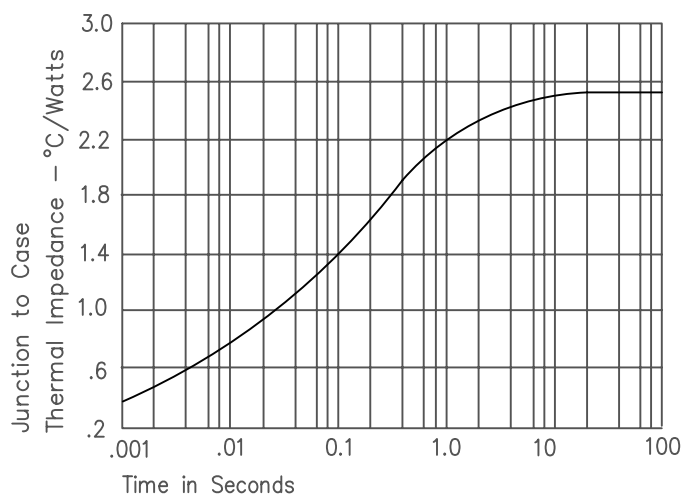



Figure 5  
Transient Thermal Impedance



## Looking for pricing, stock, or lifecycle information?

Click below to explore more details on WIN SOURCE:

-  [View 1N1348 on WIN SOURCE](#)
-  [Microchip Technology](#) Information

## Optimize Your Supply Chain with WIN SOURCE Solutions

-  Global Sourcing Solution
-  Obsolete Management
-  Cost Control Management
-  Shortage Management
-  Alternative Solution
-  Excess Inventory Management