

Power Inductors / Wire Wound type

Series: **V**
 Type: **ELLCTV**

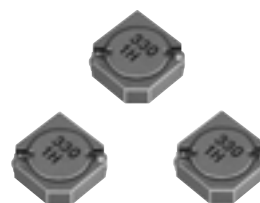

■ Features

- Magnetic shielded structure
- Low DC resistance and large current capability
- Available on tape and reel for automatic insertion
- RoHS compliant

■ Recommended Applications

- DC-DC converter circuitry for computer peripherals and amusement equipment.
- Chopper circuit decoupling chokes for DC-DC converter circuitry.

■ Standard Packing Quantity

- 500 pcs./Reel

■ Soldering Conditions and Safety Precautions

Please see Data Files

■ Explanation of Part Numbers

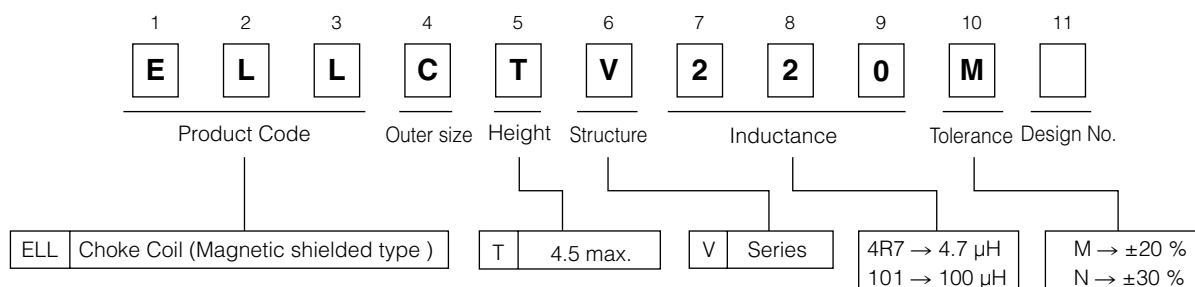

■ Dimensions in mm (not to scale)

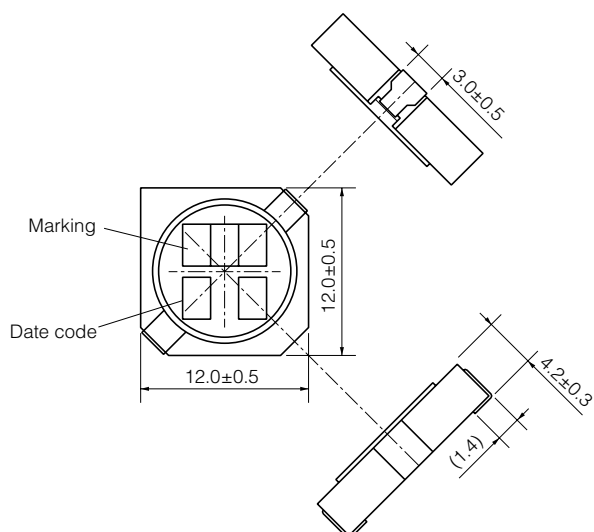

■ Recommended Land Pattern in mm (not to scale)

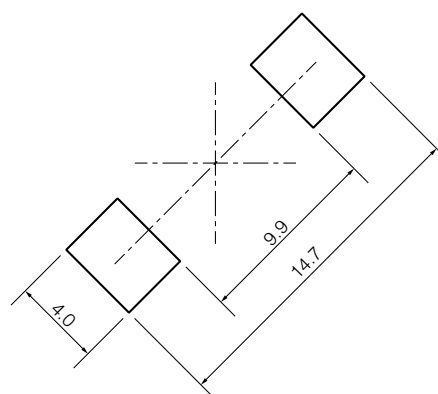

Standard Parts

Part No.	Inductance (100 kHz)		R _{DC} (at 20 °C)		* Rated Current (mA) max.	Marking
	(μH)	Tolerance	(mΩ)	Tolerance		
ELLCTV1R2N	1.2	±30 %	4.6	±20 %	6500	1R2
ELLCTV2R0N	2.0		5.6		6300	2R0
ELLCTV2R7N	2.7		7.0		5700	2R7
ELLCTV3R9N	3.9		8.5		5600	3R9
ELLCTV4R7N	4.7		9.9		5200	4R7
ELLCTV5R6N	5.6		11		4900	5R6
ELLCTV6R8N	6.8		14		4500	6R8
ELLCTV8R2N	8.2		15		4400	8R2
ELLCTV100M	10.0	±20 %	17	3900	100	
ELLCTV120M	12.0		22	3700	120	
ELLCTV150M	15.0		25	3100	150	
ELLCTV180M	18.0		30	3000	180	
ELLCTV220M	22.0		37	2700	220	
ELLCTV270M	27.0		43	2300	270	
ELLCTV330M	33.0		50	2200	330	
ELLCTV390M	39.0		61	2100	390	
ELLCTV470M	47.0		69	1900	470	
ELLCTV560M	56.0		87	1600	560	
ELLCTV680M	68.0		100	1500	680	
ELLCTV820M	82.0		120	1400	820	
ELLCTV101M	100.0		150	1200	101	
ELLCTV121M	120.0		190	1100	121	
ELLCTV151M	150.0		220	1000	151	
ELLCTV181M	180.0		270	930	181	
ELLCTV221M	220.0		310	840	221	
ELLCTV271M	270.0		400	810	271	
ELLCTV331M	330.0	500	660	331		
ELLCTV391M	390.0	560	630	391		
ELLCTV471M	470.0	690	580	471		
ELLCTV561M	560.0	810	540	561		
ELLCTV681M	680.0	1010	470	681		
ELLCTV821M	820.0	1140	440	821		
ELLCTV102M	1000.0	1500	410	102		

* Current: This indicates the value of current when the inductance is 70 % of nominal value or when the case temperature has risen 45 °C (at 20 °C)

Embossed Carrier Tape Dimensions in mm (not to scale)

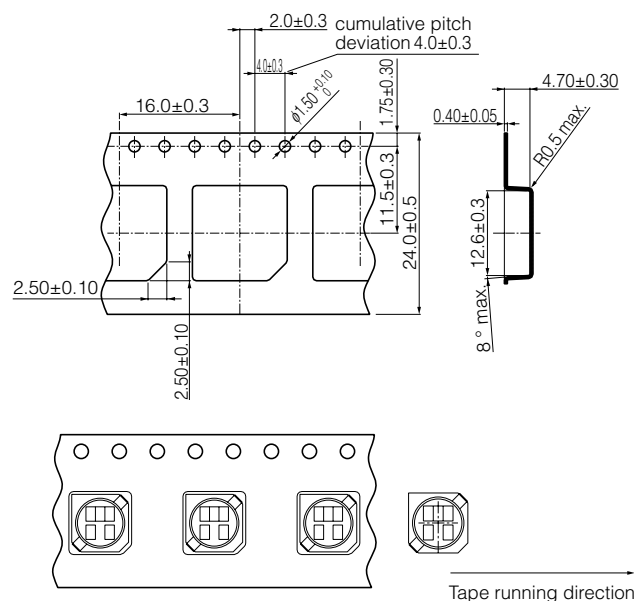

Quantity 500 pcs./reel

Guidelines and precautions regarding the technical information and use of our products described in this online catalog.

- If you want to use our products described in this online catalog for applications requiring special qualities or reliability, or for applications where the failure or malfunction of the products may directly jeopardize human life or potentially cause personal injury (e.g. aircraft and aerospace equipment, traffic and transportation equipment, combustion equipment, medical equipment, accident prevention, anti-crime equipment, and/or safety equipment), it is necessary to verify whether the specifications of our products fit to such applications. Please ensure that you will ask and check with our inquiry desk as to whether the specifications of our products fit to such applications use before you use our products.
- The quality and performance of our products as described in this online catalog only apply to our products when used in isolation. Therefore, please ensure you evaluate and verify our products under the specific circumstances in which our products are assembled in your own products and in which our products will actually be used.
- If you use our products in equipment that requires a high degree of reliability, regardless of the application, it is recommended that you set up protection circuits and redundancy circuits in order to ensure safety of your equipment.
- The products and product specifications described in this online catalog are subject to change for improvement without prior notice. Therefore, please be sure to request and confirm the latest product specifications which explain the specifications of our products in detail, before you finalize the design of your applications, purchase, or use our products.
- The technical information in this online catalog provides examples of our products' typical operations and application circuits. We do not guarantee the non-infringement of third party's intellectual property rights and we do not grant any license, right, or interest in our intellectual property.
- If any of our products, product specifications and/or technical information in this online catalog is to be exported or provided to non-residents, the laws and regulations of the exporting country, especially with regard to security and export control, shall be observed.



<Regarding the Certificate of Compliance with the EU RoHS Directive/REACH Regulations>

- The switchover date for compliance with the RoHS Directive/REACH Regulations varies depending on the part number or series of our products.
- When you use the inventory of our products for which it is unclear whether those products are compliant with the RoHS Directive/REACH Regulation, please select "Sales Inquiry" in the website inquiry form and contact us.

We do not take any responsibility for the use of our products outside the scope of the specifications, descriptions, guidelines and precautions described in this online catalog.

Looking for pricing, stock, or lifecycle information?

Click below to explore more details on WIN SOURCE:

-  [View ELL-CTV681M](#) on WIN SOURCE
-  [Panasonic](#) Information

Optimize Your Supply Chain with WIN SOURCE Solutions

-  Global Sourcing Solution
-  Obsolete Management
-  Cost Control Management
-  Shortage Management
-  Alternative Solution
-  Excess Inventory Management