

Power Inductors / Wire Wound type

Series: **V**
 Type: **ELLATV**

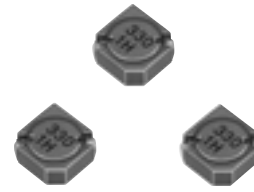

■ Features

- Magnetic shielded structure
- Low DC resistance and large current capability
- Available on tape and reel for automatic insertion
- RoHS compliant

■ Recommended Applications

- DC-DC converter circuitry for computer peripherals and amusement equipment.
- Chopper circuit decoupling chokes for DC-DC converter circuitry.

■ Standard Packing Quantity

- 500 pcs./Reel

■ Soldering Conditions and Safety Precautions

Please see Data Files

■ Explanation of Part Numbers

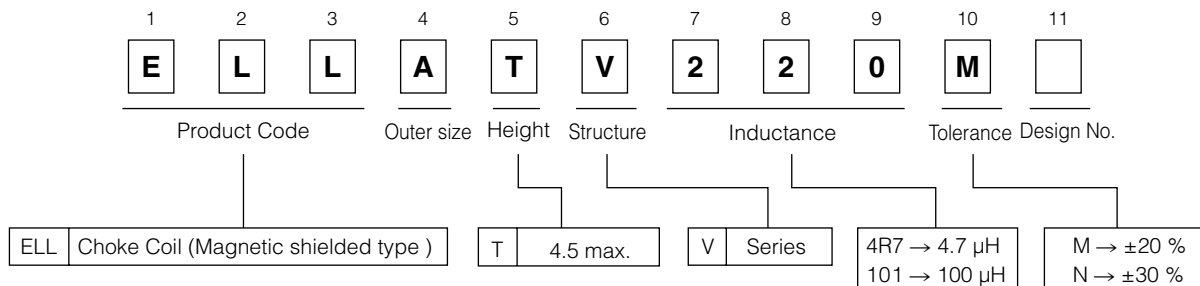

■ Dimensions in mm (not to scale)

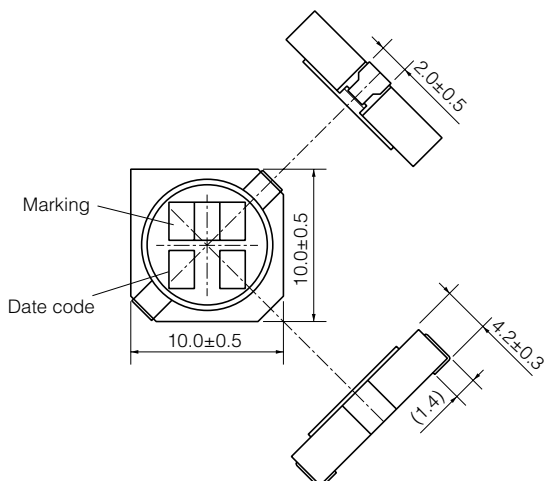

■ Recommended Land Pattern in mm (not to scale)

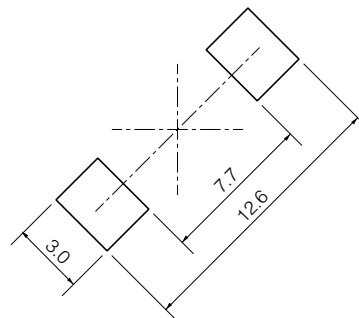

Standard Parts

Part No.	Inductance (100 kHz)		R _{DC} (at 20 °C)		* Rated Current (mA) max.	Marking
	(μH)	Tolerance	(mΩ)	Tolerance		
ELLATV1R5N	1.5	±30 %	5.3	±20 %	6700	1R5
ELLATV2R2N	2.2		6.3		6200	2R2
ELLATV3R3N	3.3		8.8		5350	3R3
ELLATV4R3N	4.3		10		5000	4R3
ELLATV5R1N	5.1		14		4350	5R1
ELLATV6R8N	6.8		16		4000	6R8
ELLATV8R2N	8.2		18		3700	8R2
ELLATV100M	10.0		23		3300	100
ELLATV120M	12.0	25	2900	120		
ELLATV150M	15.0	32	2800	150		
ELLATV180M	18.0	38	2500	180		
ELLATV220M	22.0	45	2200	220		
ELLATV270M	27.0	56	2000	270		
ELLATV330M	33.0	62	1800	330		
ELLATV390M	39.0	74	1600	390		
ELLATV470M	47.0	94	1550	470		
ELLATV560M	56.0	100	1350	560		
ELLATV680M	68.0	130	1200	680		
ELLATV820M	82.0	150	1100	820		
ELLATV101M	100.0	180	1000	101		
ELLATV121M	120.0	190	840	121		
ELLATV151M	150.0	250	780	151		
ELLATV181M	180.0	320	750	181		
ELLATV221M	220.0	360	700	221		
ELLATV271M	270.0	460	600	271		
ELLATV331M	330.0	550	550	331		
ELLATV391M	390.0	690	520	391		
ELLATV471M	470.0	780	470	471		
ELLATV561M	560.0	820	390	561		
ELLATV681M	680.0	1150	370	681		
ELLATV821M	820.0	1270	340	821		
ELLATV102M	1000.0	1750	320	102		

* Current: This indicates the value of current when the inductance is 70 % of nominal value or when the case temperature has risen 45 °C (at 20 °C)

Embossed Carrier Tape Dimensions in mm (not to scale)

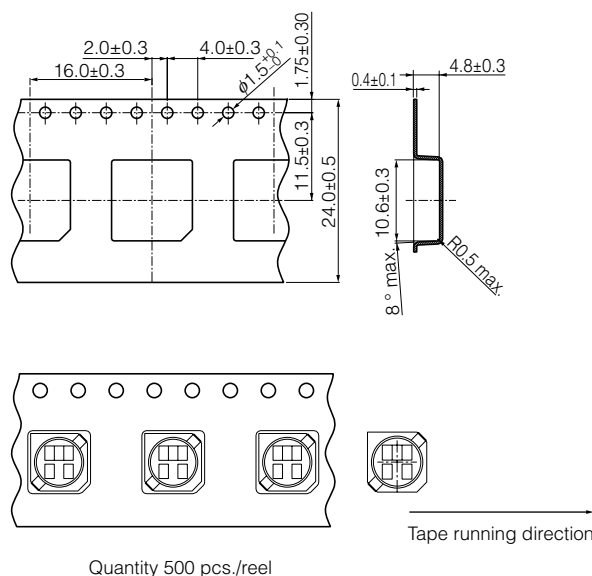

Guidelines and precautions regarding the technical information and use of our products described in this online catalog.

- If you want to use our products described in this online catalog for applications requiring special qualities or reliability, or for applications where the failure or malfunction of the products may directly jeopardize human life or potentially cause personal injury (e.g. aircraft and aerospace equipment, traffic and transportation equipment, combustion equipment, medical equipment, accident prevention, anti-crime equipment, and/or safety equipment), it is necessary to verify whether the specifications of our products fit to such applications. Please ensure that you will ask and check with our inquiry desk as to whether the specifications of our products fit to such applications use before you use our products.
- The quality and performance of our products as described in this online catalog only apply to our products when used in isolation. Therefore, please ensure you evaluate and verify our products under the specific circumstances in which our products are assembled in your own products and in which our products will actually be used.
- If you use our products in equipment that requires a high degree of reliability, regardless of the application, it is recommended that you set up protection circuits and redundancy circuits in order to ensure safety of your equipment.
- The products and product specifications described in this online catalog are subject to change for improvement without prior notice. Therefore, please be sure to request and confirm the latest product specifications which explain the specifications of our products in detail, before you finalize the design of your applications, purchase, or use our products.
- The technical information in this online catalog provides examples of our products' typical operations and application circuits. We do not guarantee the non-infringement of third party's intellectual property rights and we do not grant any license, right, or interest in our intellectual property.
- If any of our products, product specifications and/or technical information in this online catalog is to be exported or provided to non-residents, the laws and regulations of the exporting country, especially with regard to security and export control, shall be observed.



<Regarding the Certificate of Compliance with the EU RoHS Directive/REACH Regulations>

- The switchover date for compliance with the RoHS Directive/REACH Regulations varies depending on the part number or series of our products.
- When you use the inventory of our products for which it is unclear whether those products are compliant with the RoHS Directive/REACH Regulation, please select "Sales Inquiry" in the website inquiry form and contact us.

We do not take any responsibility for the use of our products outside the scope of the specifications, descriptions, guidelines and precautions described in this online catalog.

Looking for pricing, stock, or lifecycle information?

Click below to explore more details on WIN SOURCE:

-  [View ELL-ATV100M on WIN SOURCE](#)
-  [Panasonic Information](#)

Optimize Your Supply Chain with WIN SOURCE Solutions

-  Global Sourcing Solution
-  Obsolete Management
-  Cost Control Management
-  Shortage Management
-  Alternative Solution
-  Excess Inventory Management