



**THE DATASHEET OF
ELL-4LM100M**



SMD Choke Coils

Singapore

Series: **M**

Type: **ELL4□M**



Type ELL4□M

■ Features

- Magnetic shielded structure
- Low DC resistance and large current capability
- Shock resistant
- Available on tape and reel for automatic insertion

■ Recommended Applications

- DC/DC converter circuitry for computer peripherals and cellular hand sets.
- Chopper circuit decoupling chokes in DC/DC converter circuitry

■ Standard Packing Quantity

- 4GM : 2000 pcs./Reel, 4LM : 3000 pcs./Reel

■ Explanation of Part Numbers

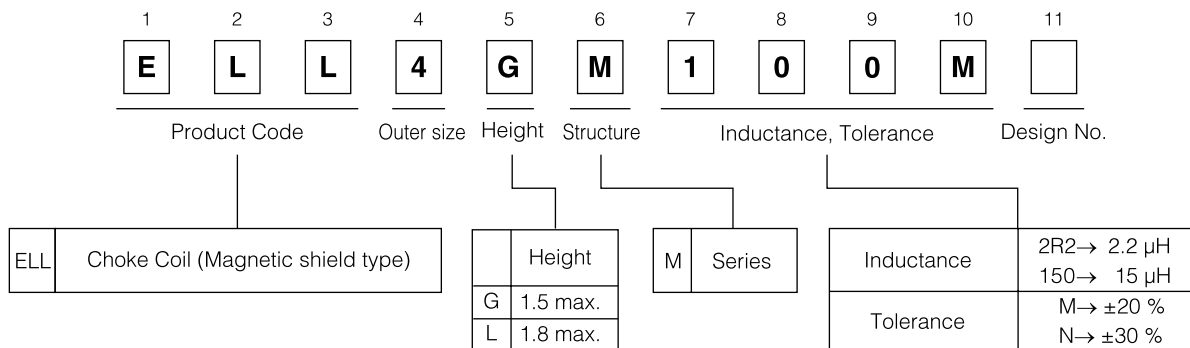

■ Dimensions in mm (not to scale)

■ Recommended land patterns in mm (not to scale)

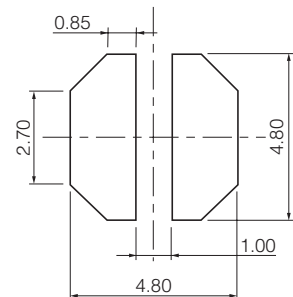
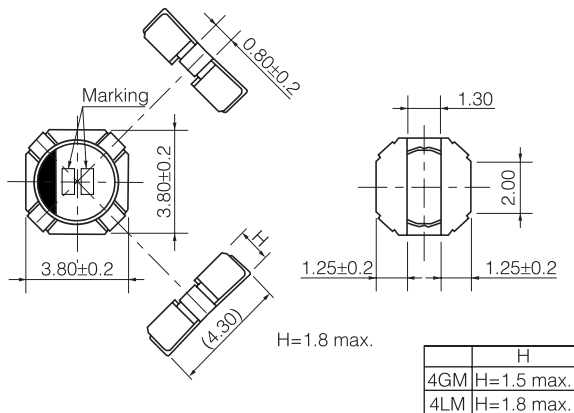

NEW

■ Standard Parts

Part Number	Inductance (100kHz)		R _{DC} (at 20 °C)		* Rated Current (mA max.)	Marking
	(μH)	Tol.	(mΩ)	Tol.		
ELL4GM2R4N	2.4	±30 %	66	±20 %	1150	12
ELL4GM3R6N	3.6		100		950	17
ELL4GM4R7N	4.7		120		800	21
ELL4GM5R6N	5.6		130		750	23
ELL4GM6R8N	6.8		180		640	26
ELL4GM8R2N	8.2		220		580	29
ELL4GM100M	10.0	±20%	260	±20 %	540	31
ELL4GM180M	18.0		490		400	35
ELL4GM220M	22.0		560		350	36
ELL4GM270M	27.0		640		330	37
ELL4GM330M	33.0		700		300	39
ELL4LM1R0N	1.0		±30%		26	±20%
ELL4LM1R5N	1.5	31		1600	06	
ELL4LM2R0N	2.0	43		1350	10	
ELL4LM2R7N	2.7	56		1250	13	
ELL4LM3R3N	3.3	62		1100	16	
ELL4LM4R7N	4.7	90		900	21	
ELL4LM6R2N	6.2	±20%	140	±20%	800	25
ELL4LM7R5N	7.5		150		720	27
ELL4LM100M	10.0		180		690	31
ELL4LM120M	12.0		200		530	32
ELL4LM150M	15.0		300		500	33
ELL4LM180M	18.0		320		460	35
ELL4LM220M	22.0	380	430	36		
ELL4LM270M	27.0	420	370	37		

* Current: This indicates the value of current when the inductance is 70% of nominal value and case temperature has risen 45 °C (at 20°C)

■ Embossed Carrier Tape Dimensions in mm (not to scale)

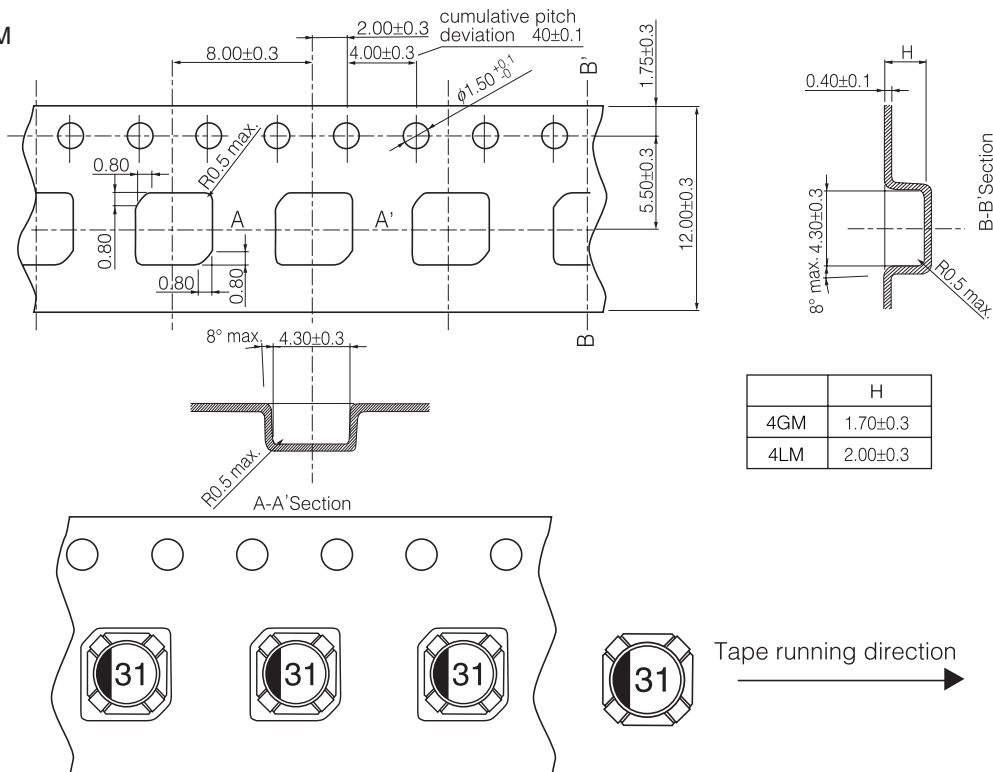

● 4GM, 4LM



Design and specifications are each subject to change without notice. Ask factory for the current technical specifications before purchase and/or use. Should a safety concern arise regarding this product, please be sure to contact us immediately.

Looking for pricing, stock, or lifecycle information?

Click below to explore more details on WIN SOURCE:

-  [View ELL-4LM100M on WIN SOURCE](#)
-  [Panasonic Information](#)

Optimize Your Supply Chain with WIN SOURCE Solutions

-  Global Sourcing Solution
-  Obsolete Management
-  Cost Control Management
-  Shortage Management
-  Alternative Solution
-  Excess Inventory Management