

4. High Power Type PF, PE, PC, PA, PB, LC, LA



■ Features

- Low DCR and large current capability, suitable for power circuitry.
- Wire wound, resin molded chip inductor. (PC, PA, PB, LC, LA type)
- Unique Ceramic Core/Laser-cut technology (PF, PE type)
- Capable of being Re-flow or flow soldered.
- Wide line-up from 1005 to 4532 case sizes.
- Good for mounting.
- RoHS compliant

■ Recommended Applications

- AV equipment, Wireless communication equipment and various types of general electronic equipment.

■ Explanation of Part Numbers



■ Storage Conditions

- Package : Normal temperature (−5 to 35 °C), normal humidity (85 %RH max.), shall not be exposed to direct sunlight and harmful gases and care should be taken so as not to cause dew.
- Operating Temperature : −40 to +85 °C (PF, PE)
−20 to +85 °C (PC, PA, PB, LC, LA)

■ Storage Period

- Solderability may be reduced due to the conditions of high temperature and high humidity which causes the oxidation of tin-plated terminals. Even if storage conditions are within specified limits, solderability may be reduced with the passage of time. Therefore, please control the storage conditions and try to use the product within 6 months of receipt.

■ Packaging Methods, Soldering Conditions and Safety Precautions

Please see Data Files.

■ PF Type 1005 (0402)

● Dimensions in mm (not to scale)



● Recommended Land Pattern in mm (not to scale)



■ Standard Packing Quantity

● 10000 pcs./Reel

■ Standard Parts

Part No.	Inductance			Q		SRF *1 (MHz) min.	R _{DC} *2 (Ω) max.	DC Current (mA) max.
	(nH)	Tolerance (%)	Test Freq. (MHz)	min.	Test Freq. (MHz)			
ELJPF2N2DFB	2.2	D : ±0.3 nH	100	7	100	5300	0.040	1900
ELJPF2N7DFB	2.7					5300	0.050	1800
ELJPF3N3DFB	3.3					5000	0.070	1500
ELJPF3N9DFB	3.9					4800	0.080	1400
ELJPF4N7DFB	4.7					4600	0.100	1300
ELJPF5N6DFB	5.6					4200	0.120	1200
ELJPF6N8JFB	6.8	J : ± 5 %	100	7	100	4000	0.160	1100
ELJPF8N2JFB	8.2					3700	0.210	900
ELJPF10NJFB	10					3200	0.260	750

*1 : Self Resonant Frequency *2 : DC Resistance

■ PE Type 1608 (0603)

● Dimensions in mm (not to scale)



● Recommended Land Pattern in mm (not to scale)

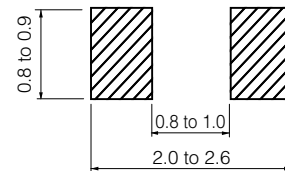

■ Standard Packing Quantity

● 3000 pcs./Reel

■ Standard Parts (E12 Series)

Part No.	Inductance			Q		SRF *1 (MHz) min.	R _{DC} *2 (Ω) max.	DC Current (mA) max.
	(nH)	Tolerance (%)	Test Freq. (MHz)	min.	Test Freq. (MHz)			
ELJPE2N2KFA	2.2	K : ± 10 %	100	8	100	6000	0.030	2100
ELJPE2N7KFA	2.7			8		5500	0.030	2100
ELJPE3N3KFA	3.3			8		5500	0.040	2100
ELJPE3N9KFA	3.9			9		5200	0.040	2100
ELJPE4N7KFA	4.7			9		4800	0.050	2100
ELJPE5N6KFA	5.6			9		4600	0.055	2100
ELJPE6N8KFA	6.8			9		4000	0.055	1900
ELJPE8N2KFA	8.2			9		3500	0.060	1700
ELJPE10NKFA	10			9		2800	0.065	1400
ELJPE12NKFA	12			9		2500	0.080	1300
ELJPE15NKFA	15			9		2200	0.100	900
ELJPE18NKFA	18			9		2000	0.120	800
ELJPE22NKFA	22			9		1800	0.150	700

*1 : Self Resonant Frequency *2 : DC Resistance

■ PC Type 2520 (1008)/PC□3 Type 2520 (1008)

● Dimensions in mm (not to scale)

● Recommended Land Pattern in mm (not to scale)

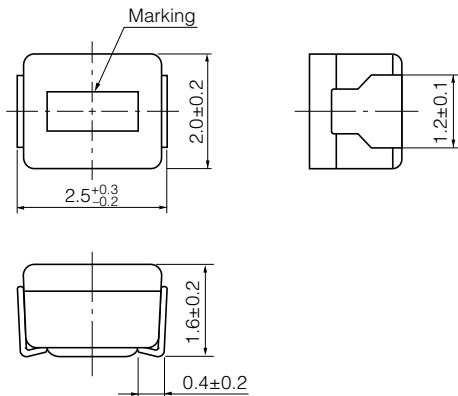

■ Standard Packing Quantity

● 2000 pcs./Reel

■ Standard Parts

Part No.	Inductance			Q		SRF *1 (MHz) min.	R _{bc} *2 (Ω) max.	DC Current (mA) max.	
	(μH)	Tolerance (%)	Test Freq. (MHz)	min.	Test Freq. (MHz)				
ELJPC1R0MF	1.0	M : ±20 %	7.96	10	7.96	95	0.45	475	
ELJPC1R5MF	1.5					85	0.55	435	
ELJPC2R2MF	2.2			65		0.65	390		
ELJPC3R3MF	3.3			55		0.85	340		
ELJPC4R7MF	4.7			43		1.2	285		
ELJPC6R8KF	6.8	K : ±10 %	2.52	8.5	2.52	44	1.3	170	
ELJPC100KF	10			20		2.52	32	2.2	210
ELJPC120KF	12						25	2.7	195
ELJPC150KF	15						21	3.2	175
ELJPC220KF	22						18	4.0	160
ELJPC330KF	33						16	6.5	120

*1 : Self Resonant Frequency *2 : DC Resistance

■ Standard Parts(PC□3 Type)

Part No.	Inductance			Self Resonant Frequency (MHz) min.	DC Resistance (Ω)	Rated Current *1 (mA) max.	Saturation Rated Current *2 (mA) max.
	(μH)	Tolerance (%)	Test Freq. (MHz)				
ELJPC1R0MF3	1.0	±20 %	1	180	0.12 ±30 %	890	400
ELJPC2R2MF3	2.2			95	0.19 ±30 %	700	330
ELJPC3R3MF3	3.3			75	0.22 ±30 %	650	260
ELJPC4R7MF3	4.7			65	0.25 ±30 %	610	220
ELJPC100MF3	10			43	0.58 ±30 %	400	140
ELJPC220MF3	22			21	1.22 ±30 %	275	100

*1 Rated current is defined by maximum temperature rise of 40 Celsius.

*2 Saturation Rated Current is defined by 30% change of inductance. -dL/L<-30%

■ PA Type 3225 (1210)/PA□2 Type 3225 (1210)

● Dimensions in mm (not to scale)

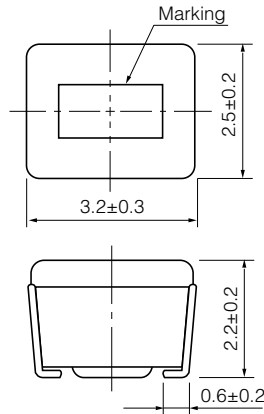

● Recommended Land Pattern in mm (not to scale)

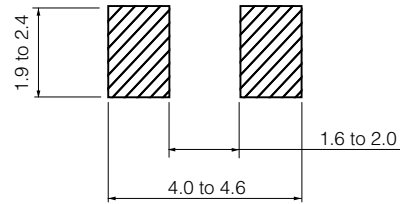

■ Standard Packing Quantity

● 2000 pcs./Reel

■ Standard Parts(PA Type)

Part No.	Inductance			Q		SRF *1 (MHz) min.	R _{DC} *2 (Ω) max.	DC Current (mA) max.			
	(μH)	Tolerance (%)	Test Freq. (MHz)	min.	Test Freq. (MHz)						
ELJPA1R0MF	1.0	M : ±20 %	7.96	7	7.96	150	0.15	600			
ELJPA1R5MF	1.5					110	0.18	550			
ELJPA2R2MF	2.2					80	0.23	500			
ELJPA3R3MF	3.3					58	0.28	400			
ELJPA4R7MF	4.7					46	0.34	350			
ELJPA6R8MF	6.8					38	0.42	300			
ELJPA100KF	10	K : ±10 %	2.52	15	2.52	23	0.50	240			
ELJPA120KF	12					21	0.60	230			
ELJPA150KF	15					18	0.74	220			
ELJPA180KF	18					17	0.90	205			
ELJPA220KF	22					15	1.15	185			
ELJPA270KF	27					13	1.45	165			
ELJPA330KF	33					12	1.65	155			
ELJPA390KF	39					11	1.90	145			
ELJPA470KF	47					9.5	2.25	135			
ELJPA560KF	56					8.5	3.30	110			
ELJPA680KF	68					7.5	3.70	105			
ELJPA820KF	82					7.0	4.20	100			
ELJPA101KF	100					0.796	20	0.796	6.5	5.00	90
ELJPA121KF	120								6.0	7.00	75
ELJPA151KF	150	5.5	8.00	70							
ELJPA181KF	180	5.0	9.50	65							
ELJPA221KF	220	4.0	11.0	60							
ELJPA271KF	270	3.5	14.5	55							
ELJPA331KF	330	3.0	16.0	50							

*1 : Self Resonant Frequency *2 : DC Resistance

■ Standard Parts(PA□2 Type)

Part No.	Inductance			Self Resonant Frequency (MHz) min.	DC Resistance (Ω)	Rated Current *1 (mA) max.	Saturation Rated Current *2 (mA) max.
	(μH)	Tolerance (%)	Test Freq. (MHz)				
ELJPA1R0MF2	1.0	M : ±20 %	1	130	0.085 ±30 %	1150	1200
ELJPA2R2MF2	2.2			70	0.17 ±30 %	800	800
ELJPA3R3MF2	3.3			42	0.19 ±30 %	750	690
ELJPA4R7MF2	4.7			35	0.23 ±30 %	700	580
ELJPA6R8MF2	6.8			28	0.28 ±30 %	620	530
ELJPA100KF2	10			K : ±10 %	1	23	0.35 ±20 %
ELJPA220KF2	22	15	0.66 ±20 %			420	290
ELJPA330KF2	33	12	1.05 ±20 %			330	240
ELJPA470KF2	47	9.5	1.75 ±20 %			260	200
ELJPA680KF2	68	7.5	3.20 ±20 %			190	160
ELJPA101KF2	100	6.5	3.90 ±20 %			175	130
ELJPA221KF2	220	4.0	8.70 ±20 %			115	85

*1 Rated current is defined by maximum temperature rise of 40 Celsius.

*2 Saturation Rated Current is defined by 30% change of inductance. -dL/L<-30%

Design and specifications are each subject to change without notice. Ask factory for the current technical specifications before purchase and/or use. Should a safety concern arise regarding this product, please be sure to contact us immediately.

■ PB Type 4532 (1812)

● Dimensions in mm (not to scale)



● Recommended Land Pattern in mm (not to scale)

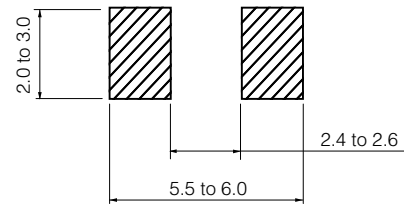

■ Standard Packing Quantity

● 500 pcs./Reel

■ Standard Parts

Part No.	Inductance			Q		SRF *1 (MHz) min.	R _{DC} *2 (Ω) max.	DC Current (mA) max.			
	(μH)	Tolerance (%)	Test Freq. (MHz)	min.	Test Freq. (MHz)						
ELJPB100KF	10	K : ±10 %	2.52	10	2.52	19	0.65	360			
ELJPB120KF	12					17	0.70	340			
ELJPB150KF	15					15	0.80	320			
ELJPB180KF	18					14	0.90	310			
ELJPB220KF	22					13	1.0	300			
ELJPB270KF	27					11	1.2	270			
ELJPB330KF	33					10	1.4	250			
ELJPB390KF	39					9.5	1.6	230			
ELJPB470KF	47					8.5	1.9	210			
ELJPB560KF	56					8	2.2	190			
ELJPB680KF	68					7	2.6	170			
ELJPB820KF	82					6.5	3.5	160			
ELJPB101KF	100					0.796	20	0.796	6	4.0	150
ELJPB121KF	120								5.5	4.5	130
ELJPB151KF	150								5	6.5	120
ELJPB181KF	180	4.5	7.5	110							
ELJPB221KF	220	4	9.0	90							

*1 : Self Resonant Frequency *2 : DC Resistance

■ LC Type 2520 (1008)

● Dimensions in mm (not to scale)

● Recommended Land Pattern in mm (not to scale)



■ Standard Packing Quantity

● 2000 pcs./Reel

■ Standard Parts

Part No.	Inductance			DC Resistance (Ω)	Rated Current *1 (mA) max.	Saturation Rated Current *2 (mA) max.
	(μH)	Tolerance (%)	Test Freq. (MHz)			
ELJLC2R2MF	2.2	M : ±20 %	1	0.33 ±30 %	520	1050
ELJLC3R3MF	3.3			0.57 ±30 %	400	820
ELJLC4R7MF	4.7			0.75 ±30 %	350	700
ELJLC100KF	10	K : ±10 %		1.60 ±30 %	240	470

*1 Rated current is defined by maximum temperature rise of 40 Celsius.

*2 Saturation Rated Current is defined by 30% change of inductance. $-dL/L < -30\%$

■ Performance Characteristics (Reference)

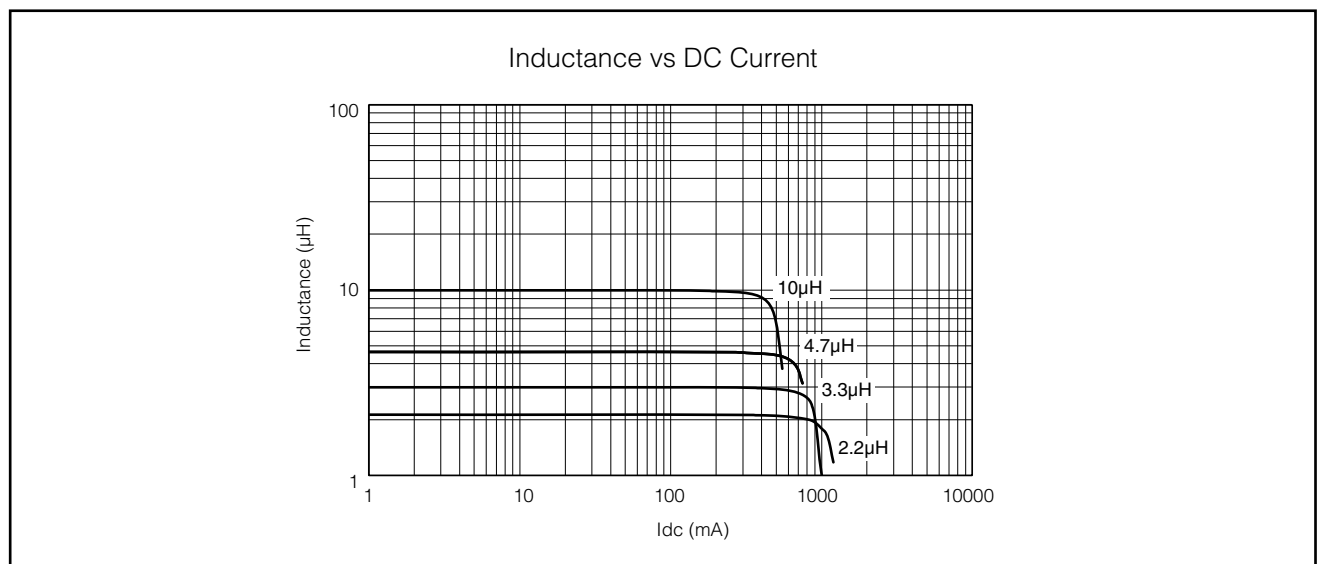

■ LA Type 3225 (1210)

● Dimensions in mm (not to scale)



● Recommended Land Pattern in mm (not to scale)



■ Standard Packing Quantity

● 2000 pcs./Reel

■ Standard Parts

Part No.	Inductance			DC Resistance (Ω)	Rated Current *1 (mA) max.	Saturation Rated Current *2 (mA) max.
	(μH)	Tolerance (%)	Test Freq. (MHz)			
ELJLA2R2KF	2.2	±10 %	1	0.20 ±30 %	740	1400
ELJLA3R3KF	3.3			0.24 ±30 %	670	1200
ELJLA4R7KF	4.7			0.35 ±30 %	560	900
ELJLA6R8KF	6.8			0.55 ±30 %	460	800
ELJLA100KF	10			0.71 ±20 %	410	600
ELJLA220KF	22			1.90 ±20 %	250	420
ELJLA470KF	47			4.30 ±20 %	165	300
ELJLA680KF	68			5.50 ±20 %	145	260
ELJLA101KF	100			9.50 ±20 %	110	200

*1 Rated current is defined by maximum temperature rise of 40 Celsius.

*2 Saturation Rated Current is defined by 30% change of inductance. $-dL/L < -30\%$

■ Performance Characteristics (Reference)

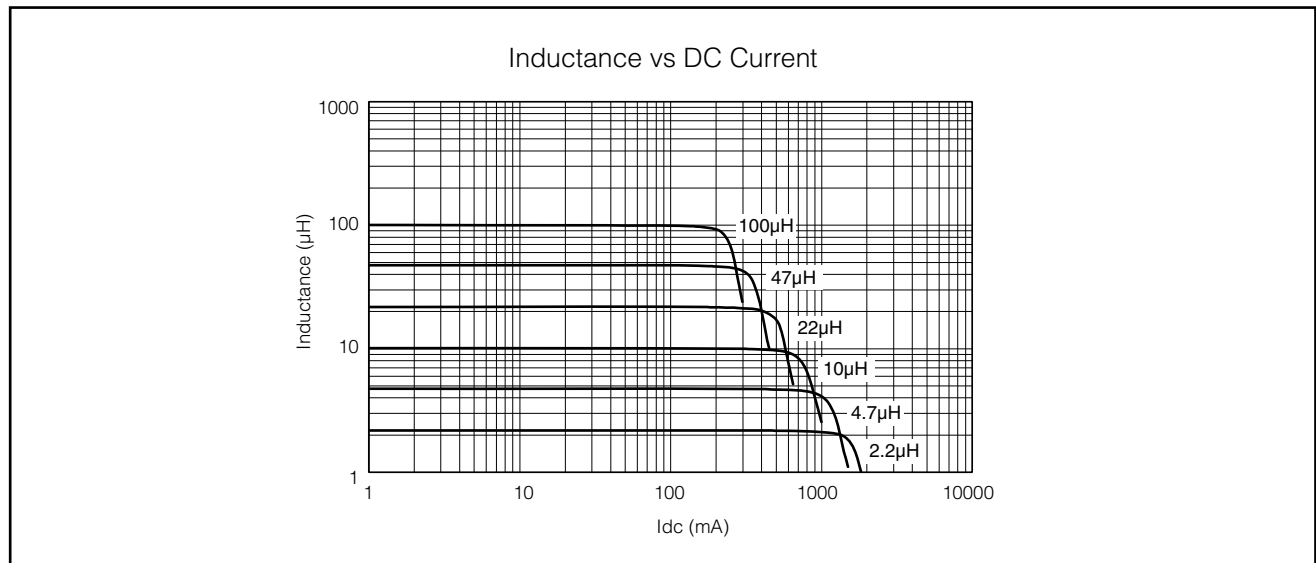

■ Packaging Methods (Taping)

● Punched Carrier Tape Dimensions in mm (not to scale)



● Embossed Carrier Tape Dimensions in mm (not to scale)

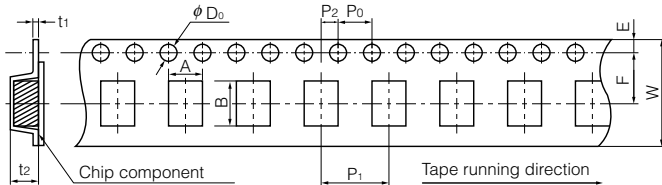

● Taping Reel Dimensions in mm (not to scale)



■ Standard Packing Quantity/Reel

Types	Quantity	Quantity
RF, QF, PF		10000 pcs.
RE, QE, PE, ND		3000 pcs.
NC, FC, PC, LC, SC		2000 pcs.
NA, FA, PA, LA, SA, EA, DA		2000 pcs.
FB, PB		500 pcs.

● Type □F

	A	B	W	E	F	P ₁
RF, QF, PF	0.71	1.21	8.0	1.75	3.5	2.0
	P ₂	P ₀	φD ₀	t ₁	t ₂	
RF, QF, PF	2.0	4.0	φ1.5	0.7 max.	1.0 max.	

● Type □E, Type ND, Type □C

	A	B	W	E	F	P ₁
RE, QE, PE	1.0	1.8	8.0	1.75	3.5	4.0
ND	1.45	2.25	8.0	1.75	3.5	4.0
NC, FC, PC, LC, SC	2.40	2.90	8.0	1.75	3.5	4.0
	P ₂	P ₀	φD ₀	φD ₁	t ₁	t ₂
RE, QE, PE	2.0	4.0	φ1.5	φ0.6	(0.27)	1.2
ND	2.0	4.0	φ1.5	φ1.0	(0.25)	1.55
NC, FC, PC, LC, SC	2.0	4.0	φ1.5	φ1.1	(0.25)	1.85

● Type □A

	A	B	W	E	F	P ₁
NA, FA, PA, LA, SA, EA, DA	2.80	3.60	8.0	1.75	3.5	4.0
	P ₂	P ₀	φD ₀	t ₁	t ₂	
NA, FA, PA, LA, SA, EA, DA	2.0	4.0	φ1.5	(0.25)	2.40	

● Type □B

	A	B	W	E	F	P ₁
FB, PB	3.60	4.90	12.0	1.75	5.5	8.0
	P ₂	P ₀	φD ₀	t ₁	t ₂	
FB, PB	2.0	4.0	φ1.5	(0.30)	3.50	

Types	Parts					
	A	B	C	D	E	W
RF, QF, PF, RE, QE, PE, ND, NC, FC, PC, LC, SC, NA, FA, PA, LA, SA, EA, DA	180	60	13	21	2	9
FB, PB	180	60	13	21	2	13

* Under conditions of high temperature and humidity deterioration of the taping and packaging may be accelerated.

Please carefully control storage conditions and use the product within 6 months of receipt.

Soldering Conditions

■ Reflow soldering conditions

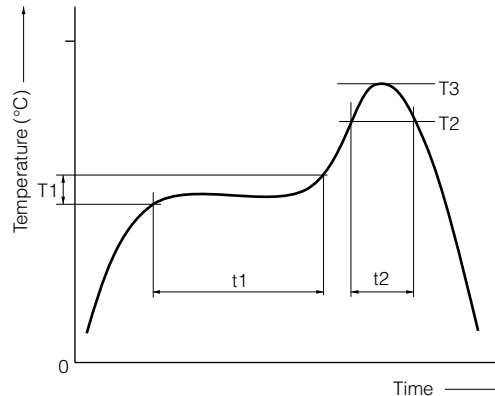

● Pb free solder recommended temperature profile

Type	Preheat		Soldering		Peak Temperature		Time of Reflow
	T1 [°C]	t1 [s]	T2 [°C]	t2 [s]	T3	T3 Limit	
□F	150 to 180	60 to 120	230 °C	40 max.	250 °C, 10 s	260 °C, 10 s	2 times max.
□E	150 to 180	60 to 120	230 °C	40 max.	250 °C, 10 s	260 °C, 10 s	2 times max.
□D	150 to 180	60 to 120	230 °C	40 max.	245 °C, 10 s	250 °C, 10 s	2 times max.
□C	150 to 180	60 to 120	230 °C	40 max.	245 °C, 10 s	250 °C, 10 s	2 times max.
□A	150 to 180	60 to 120	230 °C	40 max.	245 °C, 10 s	250 °C, 10 s	2 times max.
□B	150 to 180	60 to 120	230 °C	40 max.	245 °C, 10 s	250 °C, 10 s	2 times max.

■ Flow soldering conditions

Preheat: 130 to 150 °C, 60 to 180 s, Soldering: 260 °C, 5 s max.

■ Notes

- Solderability may be reduced due to the conditions of high temperature and high humidity which causes the oxidation of tin-plated terminals. Even if storage conditions are within specified limits, solderability may be reduced with the passage of time. Therefore, please control the storage conditions and try to use the product within 6 months of receipt.
- In case the product has been stored for a period longer than 6 months, use the product only after confirmation of its solderability.

⚠ Safety Precautions (Common precautions for Chip Inductors)

- When using our products, no matter what sort of equipment they might be used for, be sure to make a written agreement on the specifications with us in advance. The design and specifications in this catalog are subject to change without prior notice.
- Do not use the products beyond the specifications described in this catalog.
- This catalog explains the quality and performance of the products as individual components. Before use, check and evaluate their operations when installed in your products.
- Install the following systems for a failsafe design to ensure safety if these products are to be used in equipment where a defect in these products may cause the loss of human life or other significant damage, such as damage to vehicles (automobile, train, vessel), traffic lights, medical equipment, aerospace equipment, electric heating appliances, combustion/gas equipment, rotating equipment, and disaster/crime prevention equipment.
- * Systems equipped with a protection circuit and a protection device
- * Systems equipped with a redundant circuit or other system to prevent an unsafe status in the event of a single fault

⚠ Precautions for use

1. Operation range and environments

- ① These products are designed and manufactured for general and standard use in general electronic equipment (e.g. AV equipment, home electric appliances, office equipment, information and communication equipment)
- ② These products are not intended for use in the following special conditions. Before using the products, carefully check the effects on their quality and performance, and determine whether or not they can be used.
 - In liquid, such as water, oil, chemicals, or organic solvent
 - In direct sunlight, outdoors, or in dust
 - In salty air or air with a high concentration of corrosive gas, such as Cl₂, H₂S, NH₃, SO₂, or NO₂
 - In an environment where these products cause dew condensation

2. Handling

- ① Do not bring magnets or magnetized materials close to the product. The influence of their magnetic field can change the inductance value.
- ② Do not apply strong mechanical shocks by either dropping or collision with other parts.
Excessive shock can damage the part.

3. Land pattern design

- ① Please refer to the recommended land pattern for each type shown on the datasheet.
- ② Avoid placing the chip inductor on any metal pattern except the recommended land pattern because a drop of Q and mutual conductance may occur.
- ③ In case of flow soldering, venting of soldering flux gases should be made for high density assemblies to get a good solder connection.
- ④ In case of reflow soldering, consider the layout because taller components close to chip inductor tend to block thermal conduction.

4. Mounting

- ① In general, magnetic and electric characteristics of ferrite cores can be changed by applying excessively strong force. Placement force should not exceed 20 N.
- ② Do not bend or twist the PWB after mounting the part.

5. Cleaning

- ① Do not use acid or alkali agents. Some cleaning solvents may damage the part.
Confirm by testing the reliability in advance of mass production.
- ② If Ultrasonic cleaning is used, please confirm the reliability in advance.
It is possible that combined resonance of component and PWB and cavitation can cause an abnormal vibration mode to exist causing damage.

6. Caution about applying excessive current

The rated current is defined as the smaller value of either the current value when the inductance drops 10 % down from the initial point or the current value when the average temperature of coil inside rises 20 °C up from the initial point. Do not operate product over the specific max. current.

<Package markings>

Package markings include the product number, quantity, and country of origin.
In principle, the country of origin should be indicated in English.

Chip Inductors

Type: F, E, D, C, A, B





















Ceramic Core/Laser-Cut and wire wound type chip inductors for automatic and high-density mounting
Wide variation product line-up correspond to various needs

■ Recommended Applications

- Cellular phones, wireless communication equipment (W-LAN, Bluetooth), various modules, HIC, TV, VTR, PC & peripherals, DVD, DSC, STB.

■ Inductors · Selection Guide



Size : mm (inch)

Technology Case Usage	Non wound		Wire wound			
	Size 1005 (0402)	Size 1608 (0603)	Size 2012 (0805)	Size 2520 (1008)	Size 3225 (1210)	Size 4532 (1812)
High Freq. Use	ELJRF  1.0–100 nH	ELJRE  1.0–220 nH	ELJND  10–1000 nH	ELJNC  10–820 nH	ELJNA  47–8200 nH	
High Freq. High-Q	ELJQF  1.0–39 nH	ELJQE  2.2–56 nH				
General Use				ELJFC  0.22–100 μH	ELJFA  0.22–220 μH	ELJFB  0.22–1000 μH
High Power	ELJPF  2.2–10 nH	ELJPE  2.2–22 nH		ELJPC/PC□3 ELJLC  1.0–33 μH	ELJPA/PA□2 ELJLA  1.0–330 μH	ELJPB  10–220 μH
Magnetically Shielded				ELJSC  27–100 μH	ELJSA  10–270 μH	
Low DC Resistance					ELJEA  1.0–330 μH	
Signal Processing Use (Low Distortion Type)					ELJDA/ELJFA  39–100 μH	

Design and specifications are each subject to change without notice. Ask factory for the current technical specifications before purchase and/or use.
Should a safety concern arise regarding this product, please be sure to contact us immediately.

Looking for pricing, stock, or lifecycle information?

Click below to explore more details on WIN SOURCE:

-  [View ELJ-PC120KF on WIN SOURCE](#)
-  [Panasonic Information](#)

Optimize Your Supply Chain with WIN SOURCE Solutions

-  Global Sourcing Solution
-  Obsolete Management
-  Cost Control Management
-  Shortage Management
-  Alternative Solution
-  Excess Inventory Management