



**THE DATASHEET OF
ELJ-NJ8N2EF2**



■ Type 1608(0603)NJ

● Dimensions in mm (not to scale)

● Recommended Land Pattern in mm (not to scale)

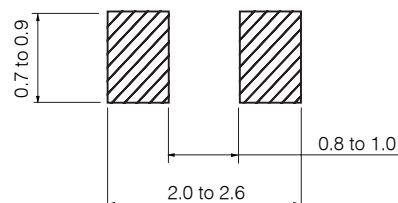
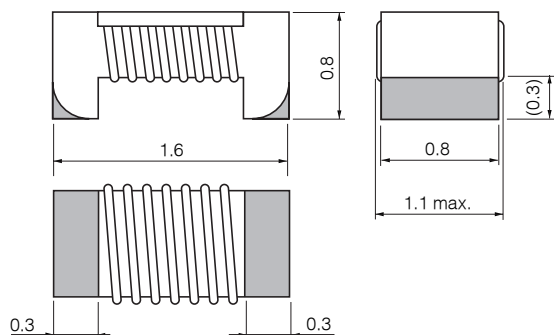

■ Examples

Part No.	Inductance		Q min.	L, Q Test Freq. (MHz)	SRF *1 (MHz)min.	DCR *2 (Ω)max.	DC Current (mA)max.
	(nH)	Tolerance					
ELJNJ6N8Z/EF2	6.8	±0.2 nH	35	250	6000	0.08	750
ELJNJ8N2Z/EF2	8.2	±0.5 nH			6000	0.10	650
ELJNJ10NG/JF2	10.0	±2 % ±5 %			6000	0.10	650
ELJNJ12NG/JF2	12.0		6000		0.13	600	
ELJNJ15NG/JF2	15.0		5000		0.13	600	
ELJNJ18NG/JF2	18.0		5000		0.15	550	
ELJNJ22NG/JF2	22.0		4600		0.17	500	
ELJNJ27NG/JF2	27.0		3800		0.20	440	
ELJNJ33NG/JF2	33.0		3500		0.23	420	
ELJNJ39NG/JF2	39.0	3200	0.25		400		
ELJNJ47NG/JF2	47.0	38	200	3000	0.28	380	
ELJNJ56NG/JF2	56.0			2700	0.30	360	
ELJNJ68NG/JF2	68.0	34	150	2300	0.35	340	
ELJNJ82NG/JF2	82.0			2200	0.48	290	
ELJNJR10G/JF2	100.0	32		150	2000	0.62	250
ELJNJR12G/JF2	120.0		1700		0.90	210	
ELJNJR15G/JF2	150.0	25	100	1400	1.30	160	
ELJNJR18G/JF2	180.0			1300	2.00	140	
ELJNJR22G/JF2	220.0			1200	2.20	120	

*1 : Self Resonant Frequency *2 : DC Resistance

Looking for pricing, stock, or lifecycle information?

Click below to explore more details on WIN SOURCE:

- ⊖ [View ELJ-NJ8N2EF2 on WIN SOURCE](#)
- ⊖ [Panasonic Information](#)

Optimize Your Supply Chain with WIN SOURCE Solutions

- ✓ Global Sourcing Solution
- ✓ Obsolete Management
- ✓ Cost Control Management
- ✓ Shortage Management
- ✓ Alternative Solution
- ✓ Excess Inventory Management