

### 6. Low DC Resistance Type EA



#### ■ Features

- Low DCR, suitable for power circuitry.
- Magnetic shield effect using ferrite mixed outer molding.
- Capable of being Re-flow or flow soldered.
- Good for mounting.
- RoHS compliant

#### ■ Recommended Applications

- AV equipment, Wireless communication equipment and various types of general electronic equipment.

#### ■ Explanation of Part Numbers

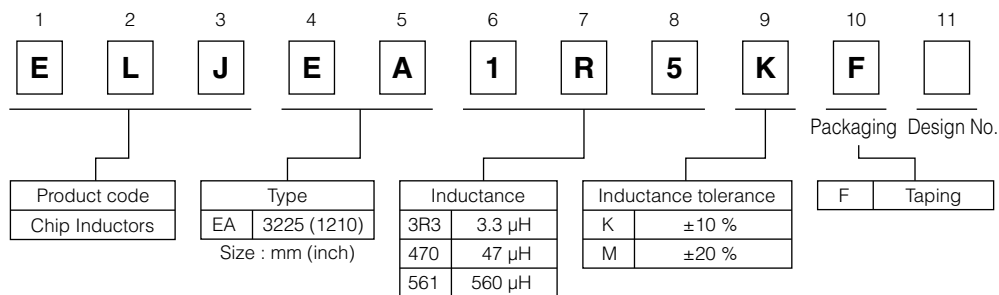

#### ■ Storage Conditions

- Package : Normal temperature (−5 to 35 °C), normal humidity (85 %RH max.), shall not be exposed to direct sunlight and harmful gases and care should be taken so as not to cause dew.
- Operating Temperature : −20 to +85 °C

#### ■ Storage Period

- Solderability may be reduced due to the conditions of high temperature and high humidity which causes the oxidation of tin-plated terminals. Even if storage conditions are within specified limits, solderability may be reduced with the passage of time. Therefore, please control the storage conditions and try to use the product within 6 months of receipt.

#### ■ Packaging Methods, Soldering Conditions and Safety Precautions

Please see Data Files.

### ■ EA Type 3225 (1210)

#### ● Dimensions in mm (not to scale)

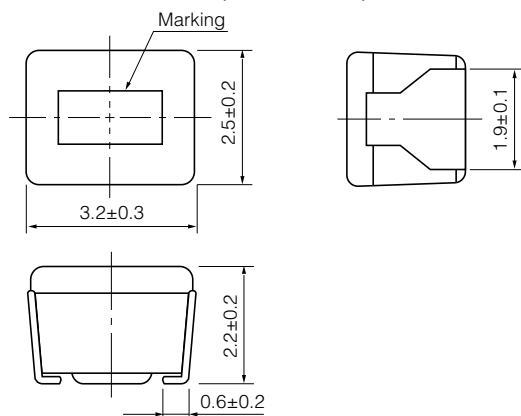

#### ● Recommended Land Pattern in mm (not to scale)

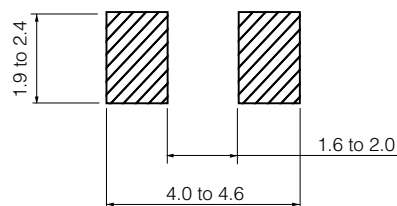

### ■ Standard Packing Quantity

- 2000 pcs./Reel

### ■ Standard Parts

Part No.	Inductance			Q		SRF *1 (MHz) min.	R <sub>DC</sub> *2 (Ω) ±30%	DC Current (mA) max.			
	(μH)	Tolerance (%)	Test Freq. (MHz)	min.	Test Freq. (MHz)						
ELJ EA1R0MF	1.0	M : ±20 %	7.96	7	7.96	100	0.07	500			
ELJ EA1R5MF	1.5					80	0.08	390			
ELJ EA2R2MF	2.2					65	0.10	350			
ELJ EA3R3MF	3.3					50	0.12	270			
ELJ EA4R7MF	4.7					46	0.14	240			
ELJ EA6R8MF	6.8					36	0.19	200			
ELJ EA100KF	10	K : ±10 %	2.52	10	2.52	29	0.26	160			
ELJ EA150KF	15					25	0.32	145			
ELJ EA220KF	22					18	0.50	115			
ELJ EA330KF	33					16	0.70	95			
ELJ EA470KF	47					13	1.0	80			
ELJ EA680KF	68					10	1.5	60			
ELJ EA101KF	100					0.796	20	0.796	8.0	2.4	50
ELJ EA151KF	150								7.0	3.1	45
ELJ EA221KF	220								5.0	5.5	35
ELJ EA331KF	330								4.0	7.1	30

\*1 : Self Resonant Frequency \*2 : DC Resistance

### ■ Packaging Methods (Taping)

#### ● Punched Carrier Tape Dimensions in mm (not to scale)

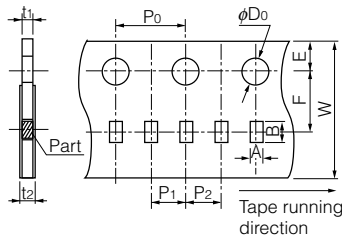

#### ● Embossed Carrier Tape Dimensions in mm (not to scale)

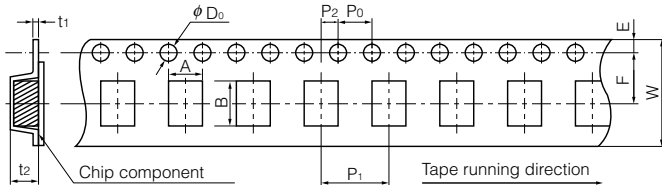
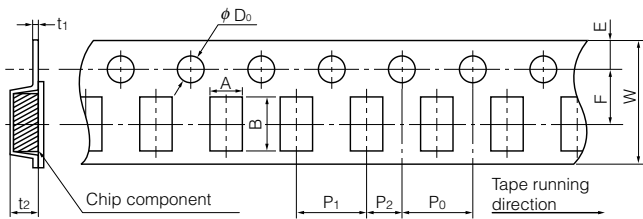
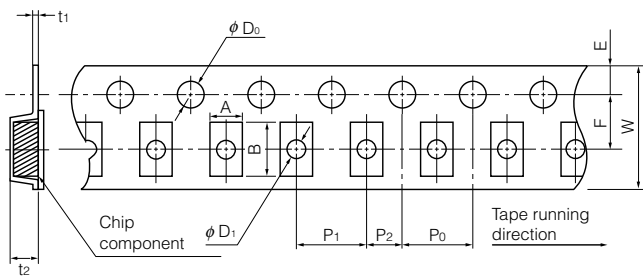

#### ● Taping Reel Dimensions in mm (not to scale)

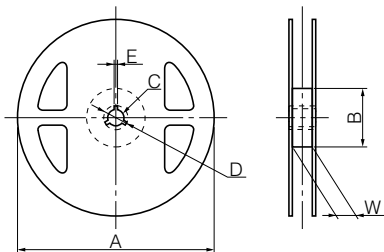

### ■ Standard Packing Quantity/Reel

Types	Quantity	Quantity
RF, QF, PF		10000 pcs.
RE, QE, PE, ND		3000 pcs.
NC, FC, PC, LC, SC		2000 pcs.
NA, FA, PA, LA, SA, EA, DA		2000 pcs.
FB, PB		500 pcs.

#### ● Type □F

	A	B	W	E	F	P <sub>1</sub>
RF, QF, PF	0.71	1.21	8.0	1.75	3.5	2.0
	P <sub>2</sub>	P <sub>0</sub>	φD <sub>0</sub>	t <sub>1</sub>	t <sub>2</sub>	
RF, QF, PF	2.0	4.0	φ1.5	0.7 max.	1.0 max.	

#### ● Type □E, Type ND, Type □C

	A	B	W	E	F	P <sub>1</sub>
RE, QE, PE	1.0	1.8	8.0	1.75	3.5	4.0
ND	1.45	2.25	8.0	1.75	3.5	4.0
NC, FC, PC, LC, SC	2.40	2.90	8.0	1.75	3.5	4.0
	P <sub>2</sub>	P <sub>0</sub>	φD <sub>0</sub>	φD <sub>1</sub>	t <sub>1</sub>	t <sub>2</sub>
RE, QE, PE	2.0	4.0	φ1.5	φ0.6	(0.27)	1.2
ND	2.0	4.0	φ1.5	φ1.0	(0.25)	1.55
NC, FC, PC, LC, SC	2.0	4.0	φ1.5	φ1.1	(0.25)	1.85

#### ● Type □A

	A	B	W	E	F	P <sub>1</sub>
NA, FA, PA, LA, SA, EA, DA	2.80	3.60	8.0	1.75	3.5	4.0
	P <sub>2</sub>	P <sub>0</sub>	φD <sub>0</sub>	t <sub>1</sub>	t <sub>2</sub>	
NA, FA, PA, LA, SA, EA, DA	2.0	4.0	φ1.5	(0.25)	2.40	

#### ● Type □B

	A	B	W	E	F	P <sub>1</sub>
FB, PB	3.60	4.90	12.0	1.75	5.5	8.0
	P <sub>2</sub>	P <sub>0</sub>	φD <sub>0</sub>	t <sub>1</sub>	t <sub>2</sub>	
FB, PB	2.0	4.0	φ1.5	(0.30)	3.50	

Types	Parts					
	A	B	C	D	E	W
RF, QF, PF, RE, QE, PE, ND, NC, FC, PC, LC, SC, NA, FA, PA, LA, SA, EA, DA	180	60	13	21	2	9
FB, PB	180	60	13	21	2	13

\* Under conditions of high temperature and humidity deterioration of the taping and packaging may be accelerated.

Please carefully control storage conditions and use the product within 6 months of receipt.

## Soldering Conditions

### ■ Reflow soldering conditions

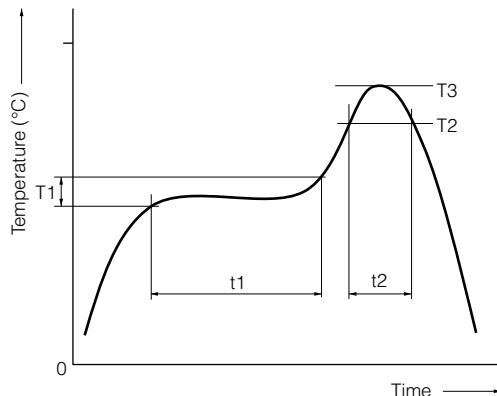

### ● Pb free solder recommended temperature profile

Type	Preheat		Soldering		Peak Temperature		Time of Reflow
	T1 [°C]	t1 [s]	T2 [°C]	t2 [s]	T3	T3 Limit	
□F	150 to 180	60 to 120	230 °C	40 max.	250 °C, 10 s	260 °C, 10 s	2 times max.
□E	150 to 180	60 to 120	230 °C	40 max.	250 °C, 10 s	260 °C, 10 s	2 times max.
□D	150 to 180	60 to 120	230 °C	40 max.	245 °C, 10 s	250 °C, 10 s	2 times max.
□C	150 to 180	60 to 120	230 °C	40 max.	245 °C, 10 s	250 °C, 10 s	2 times max.
□A	150 to 180	60 to 120	230 °C	40 max.	245 °C, 10 s	250 °C, 10 s	2 times max.
□B	150 to 180	60 to 120	230 °C	40 max.	245 °C, 10 s	250 °C, 10 s	2 times max.

### ■ Flow soldering conditions

Preheat: 130 to 150 °C, 60 to 180 s, Soldering: 260 °C, 5 s max.

### ■ Notes

- Solderability may be reduced due to the conditions of high temperature and high humidity which causes the oxidation of tin-plated terminals. Even if storage conditions are within specified limits, solderability may be reduced with the passage of time. Therefore, please control the storage conditions and try to use the product within 6 months of receipt.
- In case the product has been stored for a period longer than 6 months, use the product only after confirmation of its solderability.

## ⚠ Safety Precautions (Common precautions for Chip Inductors)

- When using our products, no matter what sort of equipment they might be used for, be sure to make a written agreement on the specifications with us in advance. The design and specifications in this catalog are subject to change without prior notice.
- Do not use the products beyond the specifications described in this catalog.
- This catalog explains the quality and performance of the products as individual components. Before use, check and evaluate their operations when installed in your products.
- Install the following systems for a failsafe design to ensure safety if these products are to be used in equipment where a defect in these products may cause the loss of human life or other significant damage, such as damage to vehicles (automobile, train, vessel), traffic lights, medical equipment, aerospace equipment, electric heating appliances, combustion/gas equipment, rotating equipment, and disaster/crime prevention equipment.
- \* Systems equipped with a protection circuit and a protection device
- \* Systems equipped with a redundant circuit or other system to prevent an unsafe status in the event of a single fault

## ⚠ Precautions for use

### 1. Operation range and environments

- ① These products are designed and manufactured for general and standard use in general electronic equipment (e.g. AV equipment, home electric appliances, office equipment, information and communication equipment)
- ② These products are not intended for use in the following special conditions. Before using the products, carefully check the effects on their quality and performance, and determine whether or not they can be used.
  - In liquid, such as water, oil, chemicals, or organic solvent
  - In direct sunlight, outdoors, or in dust
  - In salty air or air with a high concentration of corrosive gas, such as Cl<sub>2</sub>, H<sub>2</sub>S, NH<sub>3</sub>, SO<sub>2</sub>, or NO<sub>2</sub>
  - In an environment where these products cause dew condensation

### 2. Handling

- ① Do not bring magnets or magnetized materials close to the product. The influence of their magnetic field can change the inductance value.
- ② Do not apply strong mechanical shocks by either dropping or collision with other parts.  
Excessive shock can damage the part.

### 3. Land pattern design

- ① Please refer to the recommended land pattern for each type shown on the datasheet.
- ② Avoid placing the chip inductor on any metal pattern except the recommended land pattern because a drop of Q and mutual conductance may occur.
- ③ In case of flow soldering, venting of soldering flux gases should be made for high density assemblies to get a good solder connection.
- ④ In case of reflow soldering, consider the layout because taller components close to chip inductor tend to block thermal conduction.

### 4. Mounting

- ① In general, magnetic and electric characteristics of ferrite cores can be changed by applying excessively strong force. Placement force should not exceed 20 N.
- ② Do not bend or twist the PWB after mounting the part.

### 5. Cleaning

- ① Do not use acid or alkali agents. Some cleaning solvents may damage the part.  
Confirm by testing the reliability in advance of mass production.
- ② If Ultrasonic cleaning is used, please confirm the reliability in advance.  
It is possible that combined resonance of component and PWB and cavitation can cause an abnormal vibration mode to exist causing damage.

### 6. Caution about applying excessive current

The rated current is defined as the smaller value of either the current value when the inductance drops 10 % down from the initial point or the current value when the average temperature of coil inside rises 20 °C up from the initial point. Do not operate product over the specific max. current.

### <Package markings>

Package markings include the product number, quantity, and country of origin.  
In principle, the country of origin should be indicated in English.

### Chip Inductors

Type: F, E, D, C, A, B

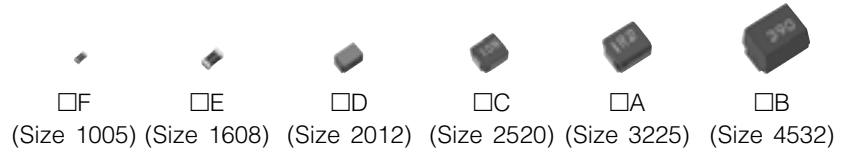



















Ceramic Core/Laser-Cut and wire wound type chip inductors for automatic and high-density mounting  
 Wide variation product line-up correspond to various needs

#### ■ Recommended Applications

- Cellular phones, wireless communication equipment (W-LAN, Bluetooth), various modules, HIC, TV, VTR, PC & peripherals, DVD, DSC, STB.

#### ■ Inductors · Selection Guide



Size : mm (inch)

Technology Case Usage	Non wound		Wire wound			
	Size 1005 (0402)	Size 1608 (0603)	Size 2012 (0805)	Size 2520 (1008)	Size 3225 (1210)	Size 4532 (1812)
High Freq. Use	ELJRF  1.0–100 nH	ELJRE  1.0–220 nH	ELJND  10–1000 nH	ELJNC  10–820 nH	ELJNA  47–8200 nH	
High Freq. High-Q	ELJQF  1.0–39 nH	ELJQE  2.2–56 nH				
General Use				ELJFC  0.22–100 μH	ELJFA  0.22–220 μH	ELJFB  0.22–1000 μH
High Power	ELJPF  2.2–10 nH	ELJPE  2.2–22 nH		ELJPC/PC□3 ELJLC  1.0–33 μH	ELJPA/PA□2 ELJLA  1.0–330 μH	ELJPB  10–220 μH
Magnetically Shielded				ELJSC  27–100 μH	ELJSA  10–270 μH	
Low DC Resistance					ELJEA  1.0–330 μH	
Signal Processing Use (Low Distortion Type)					ELJDA/ELJFA  39–100 μH	

Design and specifications are each subject to change without notice. Ask factory for the current technical specifications before purchase and/or use.  
 Should a safety concern arise regarding this product, please be sure to contact us immediately.

## Looking for pricing, stock, or lifecycle information?

Click below to explore more details on WIN SOURCE:

-  [View ELJ-EA100KF](#) on WIN SOURCE
-  [Panasonic](#) Information

## Optimize Your Supply Chain with WIN SOURCE Solutions

-  Global Sourcing Solution
-  Obsolete Management
-  Cost Control Management
-  Shortage Management
-  Alternative Solution
-  Excess Inventory Management