



THE DATASHEET OF ELC-3FN680M



SMD Choke Coils

Series: **N**
 Type: **ELC3FN**
ELC3GN

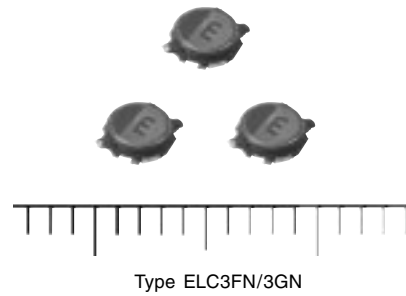

■ Features

- Low DC resistance and large current capability
- Shock resistant

■ Recommended Applications

- DC-DC converter circuitry for computer peripherals and cellular phones.
- Chopper circuit decoupling chokes for DC-DC converter circuitry

■ Standard Packing Quantity

- 2000 pcs./Reel

■ Explanation of Part Numbers

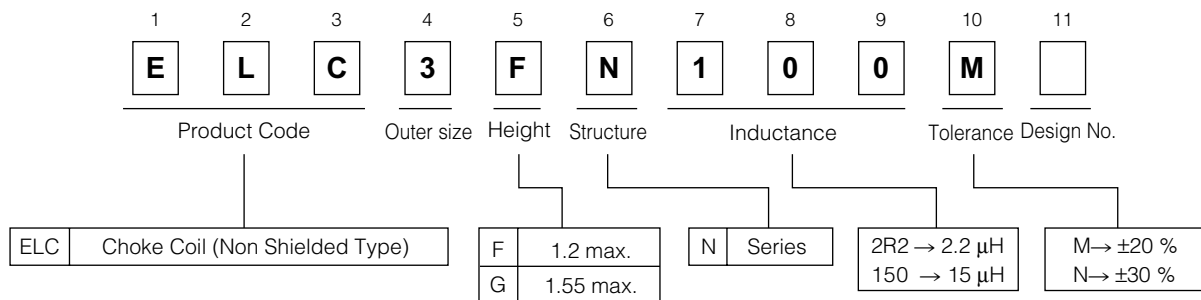

■ Dimensions in mm (not to scale)

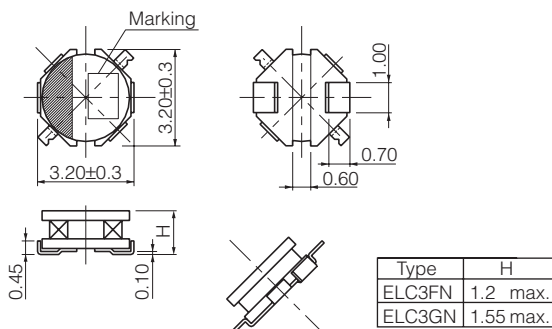

■ Recommended land patterns in mm (not to scale)

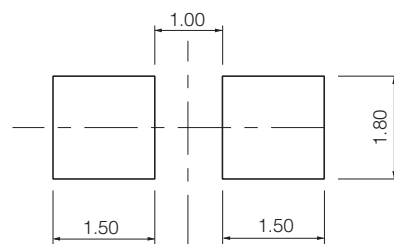

Standard Parts

Series	Part Number	Inductance (100 kHz)		R _{DC} (at 20 °C)		*Rated Current (mA max.)	Marking
		(μH)	Tol.	(mΩ)	Tol.		
3FN Series	ELC3FN1R0N	1.0	±30 %	80	±20 %	1400	A
	ELC3FN1R8N	1.8		110		1100	C
	ELC3FN2R2N	2.2		120		1000	D
	ELC3FN2R7N	2.7		150		950	E
	ELC3FN3R9N	3.9		240		770	F
	ELC3FN4R7N	4.7		280		750	H
	ELC3FN5R6N	5.6		310		680	I
	ELC3FN6R8N	6.8	360	620		K	
	ELC3FN7R5N	7.5	390	600		L	
	ELC3FN100M	10.0	430	530		M	
	ELC3FN150M	15.0	1000	370		O	
	ELC3FN220M	22.0	1180	330		R	
	ELC3FN330M	33.0	1900	260		T	
	ELC3FN470M	47.0	2450	230		V	
ELC3FN680M	68.0	4200	170	X			
3GN Series	ELC3GN1R0N	1.0	±30 %	64	±20 %	1300	A
	ELC3GN1R6N	1.6		83		1200	C
	ELC3GN2R2N	2.2		100		1000	D
	ELC3GN3R3N	3.3		130		970	E
	ELC3GN4R7N	4.7		200		760	H
	ELC3GN6R8N	6.8		250		680	K
	ELC3GN8R2N	8.2	410	540		L	
	ELC3GN100M	10.0	430	530		M	
	ELC3GN150M	15.0	600	430		O	
	ELC3GN220M	22.0	950	330		R	
	ELC3GN330M	33.0	1400	280		T	
	ELC3GN470M	47.0	1950	240		V	
	ELC3GN680M	68.0	3000	190		X	

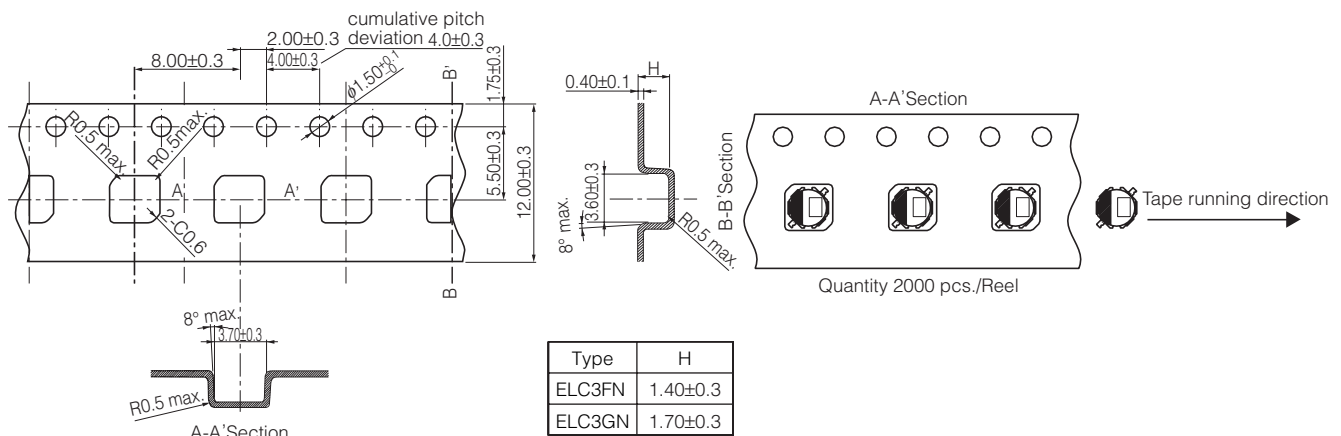

* Current: This indicates the value of current when the inductance is 70% of nominal value and case temperature has risen 45 °C (at 20 °C)

Embossed Carrier Tape Dimensions in mm (not to scale)



Looking for pricing, stock, or lifecycle information?

Click below to explore more details on WIN SOURCE:

-  [View ELC-3FN680M on WIN SOURCE](#)
-  [Panasonic Information](#)

Optimize Your Supply Chain with WIN SOURCE Solutions

-  Global Sourcing Solution
-  Obsolete Management
-  Cost Control Management
-  Shortage Management
-  Alternative Solution
-  Excess Inventory Management