

Surface Mount Type

Series : **HB** Type : **V**

Long life

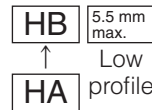

Features

- Endurance: 105 °C 2000 h
- 5.8 mm height (≤ φ6.3), 5.5 mm height max.
- Vibration-proof product is available upon request. (φ8 mm and larger)
- RoHS compliant

Specifications

Category temperature range	-40 °C to +105 °C								
Rated voltage range	4 V.DC to 50 V.DC								
Capacitance range	1 μF to 470 μF								
Capacitance tolerance	±20 % (120 Hz/+20 °C)								
Leakage current	I ≤ 0.01 CV or 3 (μA) After 2 minutes (Bi-polar I ≤ 0.02 CV or 6 (μA) after 2 minutes) (Whichever is greater)								
Dissipation factor (tan δ)	Please see the attached characteristics list								
Characteristics at low temperature	V.DC	4	6.3	10	16	25	35	50	(Impedance ratio at 120 Hz)
	Z(-25 °C)/Z(+20 °C)	7	4	3	2	2	2	2	
	Z(-40 °C)/Z(+20 °C)	15	8	6	4	4	3	3	
Endurance	After applying rated working voltage for 2000 hours (Bi-polar : 1000 hours for each polarity) at +105 °C±2 °C and then being stabilized at +20 °C, Capacitors shall meet the following limits.								
	Capacitance change	Within ±20 % of the initial value (4 V.DC : ±35 % 6.3 V.DC : ±25 % φ4 to φ6.3), 5.5 mm max. : ±25 %							
	tan δ	≤ 200 % of the initial limit							
Shelf life	After storage for 1000 hours at +105 °C±2 °C with no voltage applied and then being stabilized at +20 °C, capacitors shall meet the limits specified in Endurance. (With voltage treatment)								
	DC leakage current Within the initial limit								
Resistance to soldering heat	After reflow soldering and then being stabilized at +20 °C, capacitors shall meet the following limits.								
	Capacitance change	Within ±10 % of the initial value							
	tan δ	Within the initial limit							
AEC-Q200	DC leakage current Within the initial limit								
	AEC-Q200 compliant								

Frequency correction factor for ripple current

Frequency (Hz)	50, 60	120	1 k	10 k to
Correction factor	0.70	1.00	1.30	1.70

Marking

Example : 4 V.DC 47 μF
Marking color : BLACK

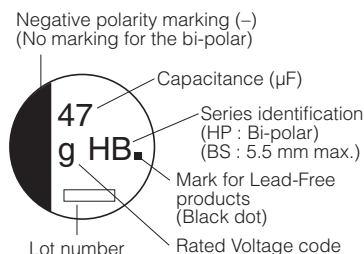

R. Voltage (V.DC)	4	6.3	10	16	25	35	50
Code	g	j	A	C	E	V	H

Dimensions

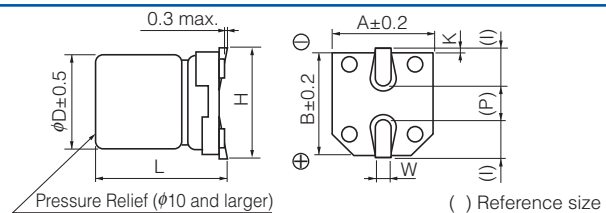

Size code	φD	L	A, B	H	I	W	P	K
B	4.0	5.8±0.3	4.3	5.5 max.	1.8	0.65±0.1	1.0	0.35 ^{+0.15} _{-0.20}
C	5.0	5.8±0.3	5.3	6.5 max.	2.2	0.65±0.1	1.5	0.35 ^{+0.15} _{-0.20}
D	6.3	5.8±0.3	6.6	7.8 max.	2.6	0.65±0.1	1.8	0.35 ^{+0.15} _{-0.20}
E	8.0	6.2±0.3	8.3	9.5 max.	3.4	0.65±0.1	2.2	0.35 ^{+0.15} _{-0.20}
F	8.0	10.2±0.3	8.3	10.0 max.	3.4	0.90±0.2	3.1	0.70±0.20
G	10.0	10.2±0.3	10.3	12.0 max.	3.5	0.90±0.2	4.6	0.70±0.20

● 5.5 mm height max.

Size code	φD	L	A, B	H	I	W	P	K
B	4.0	5.4 ^{+0.1} _{-0.2}	4.3	5.5 max.	1.8	0.65±0.1	1.0	0.35 ^{+0.15} _{-0.20}
C	5.0	5.4 ^{+0.1} _{-0.2}	5.3	6.5 max.	2.2	0.65±0.1	1.5	0.35 ^{+0.15} _{-0.20}
D	6.3	5.4 ^{+0.1} _{-0.2}	6.6	7.8 max.	2.6	0.65±0.1	1.8	0.35 ^{+0.15} _{-0.20}

Dimensions (Vibration-proof products)

* The size and shape are different from standard products. Please inquire details of our company.

< Size code : D, D8 >

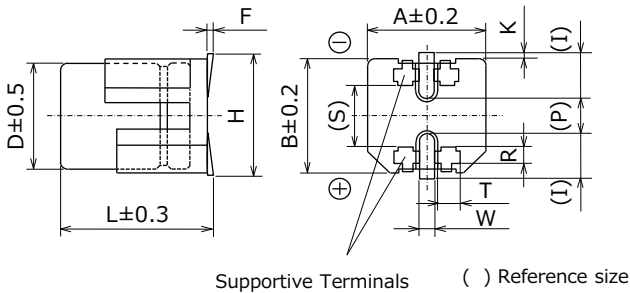

< Size code : E, F, G, H13, J16, K16, K21 >

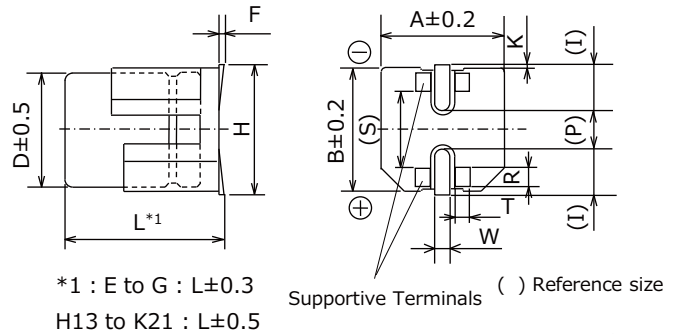

*1 : E to G : L±0.3
H13 to K21 : L±0.5

Unit : mm

Size code	φD	L	A, B	H max.	F	I	W	P	K	R	S	T
D	6.3	6.1	6.6	7.8	0 to +0.15	2.4	0.65±0.1	2.2	0.35 ^{+0.15} _{-0.20}	1.1±0.2	3.3±0.2	1.05±0.2
D8	6.3	8.0	6.6	7.8	0 to +0.15	2.4	0.65±0.1	2.2	0.35 ^{+0.15} _{-0.20}	1.1±0.2	3.3±0.2	1.05±0.2
E	8.0	6.5	8.3	9.5	0 to +0.15	3.4	0.7±0.1	2.2	0.35 ^{+0.15} _{-0.20}	0.70±0.2	5.3±0.2	1.7±0.2
F	8.0	10.5	8.3	10.0	0 to +0.15	3.4	1.2±0.2	3.1	0.70±0.2	0.70±0.2	5.3±0.2	1.3±0.2
G	10.0	10.5	10.3	12.0	0 to +0.15	3.5	1.2±0.2	4.6	0.70±0.2	0.70±0.2	6.9±0.2	1.3±0.2
H13	12.5	13.8	13.5	15.0	-0.1 to +0.15	4.7	1.2±0.2	4.4	0.70±0.3	2.2±0.2	7.1±0.2	2.4±0.2
J16	16.0	16.8	17.0	19.0	-0.1 to +0.15	5.5	1.4±0.2	6.7	0.70±0.3	3.0±0.2	9.0±0.2	1.9±0.2
K16	18.0	16.8	19.0	21.0	-0.1 to +0.15	6.7	1.4±0.2	6.7	0.70±0.3	3.0±0.2	11.0±0.2	1.9±0.2
K21	18.0	21.8	19.0	21.0	-0.1 to +0.15	6.7	1.4±0.2	6.7	0.70±0.3	3.0±0.2	11.0±0.2	1.9±0.2

Land / Pad pattern

The circuit board land/pad pattern size for chip capacitors is specified in the following table. The land pitch influences installation strength and consider it.

● Standard products

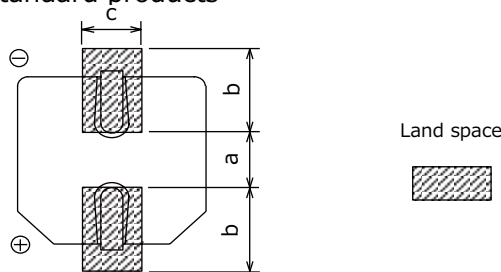

(Table of board land size vs. capacitor size)

Size code	a	b	c
B (φ4)	1.0	2.5	1.6
C (φ5)	1.5	2.8	1.6
D (φ6.3)	1.8	3.2	1.6
D8 (φ6.3x7.7L)	1.8	3.2	1.6
E (φ8x6.2L)	2.2	4.0	1.6
F (φ8x10.2L)	3.1	4.0	2.0
G (φ10x10.2L)	4.6	4.1	2.0
H (φ12.5)	4.0	5.7	2.0
J (φ16)	6.0	6.5	2.5
K (φ18)	6.0	7.5	2.5

Unit : mm

When size "a" is wide, back fillet can be made, decreasing fitting strength.

● Vibration-proof products

< Size code : D, D8 >

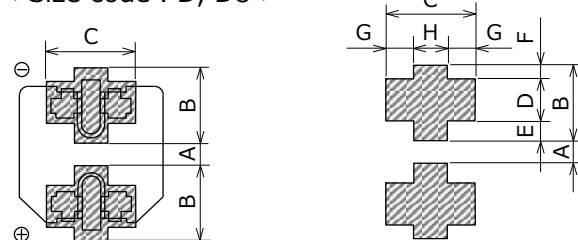

(Table of board land size vs. capacitor size)

Size code	A	B	C	D	E	F	G	H
D (φ6.3xL6.1)	1.2	3.6	3.2	2.0	0.95	0.65	1.0	1.2
D8 (φ6.3xL8.0)	1.2	3.6	3.2	2.0	0.95	0.65	1.0	1.2
E (φ8x6.5L)	1.8	4.2	5.0	1.3	1.5	1.4	1.5	2.0
F (φ8x10.5L)	2.7	4.0	4.7	1.3	1.0	1.7	1.1	2.5
G (φ10)	3.9	4.4	4.7	1.3	1.2	1.9	1.1	2.5
H (φ12.5)	3.9	6.0	6.9	2.8	1.3	1.9	2.2	2.5
J (φ16)	5.8	6.8	6.2	3.6	1.3	1.9	1.7	2.8
K (φ18)	5.8	7.3	6.2	3.6	1.8	1.9	1.7	2.8

Unit : mm

When size "A" is wide, back fillet can be made, decreasing fitting strength.

< Size code : E, F, G, H, J, K >

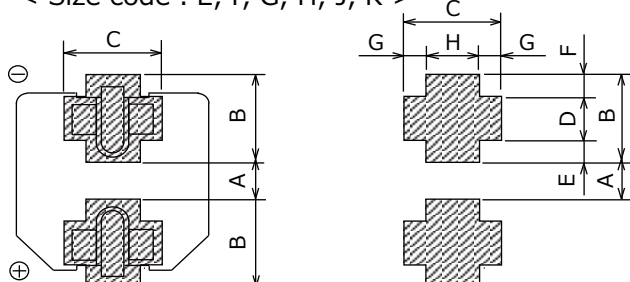

* Take mounting conditions, solderability and fitting strength into consideration when selecting parts for your company's design.

* The vibration-proof capacitors of size φ6.3 has support terminals extending from the bottom side to the lead edge. Then, make sure to find appropriate soldering conditions to form fillet on the support terminals if required for appearance inspection.

Characteristics list

Endurance : 105 °C 2000 h

Rated voltage (V.DC)	Cap. (±20 %) (μF)	Case size (mm)		Size code	Specification		Part No.	Reflow	Min. Packaging Q'ty
		φD	L		Ripple current (120 Hz) (+105 °C) (mA r.m.s.)	tan δ (120 Hz) (+20 °C)			Taping (pcs)
4	47	4	5.8	B	34	0.50	EEEHB0G470R	(1)	2000
	100	5	5.8	C	61	0.50	EEEHB0G101R	(1)	1000
	150	6.3	5.8	D	82	0.50	EEEHB0G151P	(1)	1000
	220	6.3	5.8	D	82	0.50	EEEHB0G221P	(1)	1000
6.3	22	4	5.8	B	26	0.30	EEEHB0J220R	(1)	2000
	33	4	5.8	B	29	0.30	EEEHB0J330R	(1)	2000
	47	5	5.8	C	46	0.30	EEEHB0J470R	(1)	1000
	100	6.3	5.8	D	71	0.30	EEEHB0J101P	(1)	1000
	220	8	10.2	F	150	0.35	EEEHB0J221P	(2)	500
	330	8	10.2	F	230	0.35	EEEHB0J331P	(2)	500
10	33	5	5.8	C	43	0.22	EEEHB1A330R	(1)	1000
	100	8	6.2	E	110	0.26	EEEHB1A101P	(2)	1000
	220	8	10.2	F	160	0.26	EEEHB1A221P	(2)	500
	470	10	10.2	G	270	0.26	EEEHB1A471P	(2)	500
16	10	4	5.8	B	28	0.16	EEEHB1C100R	(1)	2000
	22	5	5.8	C	39	0.16	EEEHB1C220R	(1)	1000
	47	6.3	5.8	D	70	0.16	EEEHB1C470P	(1)	1000
	100	8	10.2	F	120	0.20	EEEHB1C101P	(2)	500
	220	10	10.2	G	210	0.20	EEEHB1C221P	(2)	500
	330	10	10.2	G	230	0.20	EEEHB1C331P	(2)	500
25	4.7	4	5.8	B	22	0.14	EEEHB1E4R7R	(1)	2000
	6.8	4	5.8	B	25	0.14	EEEHB1E6R8R	(1)	2000
	33	6.3	5.8	D	65	0.14	EEEHB1E330P	(1)	1000
	47	8	6.2	E	91	0.16	EEEHB1E470P	(2)	1000
	100	8	10.2	F	130	0.16	EEEHB1E101P	(2)	500
	220	10	10.2	G	190	0.16	EEEHB1E221P	(2)	500
35	10	5	5.8	C	28	0.12	EEEHB1V100R	(1)	1000
	22	6.3	5.8	D	55	0.12	EEEHB1V220P	(1)	1000
	33	8	6.2	E	84	0.14	EEEHB1V330P	(2)	1000
	47	8	10.2	F	98	0.14	EEEHB1V470P	(2)	500
	100	10	10.2	G	160	0.14	EEEHB1V101P	(2)	500
50	1	4	5.8	B	10	0.12	EEEHB1H1R0R	(1)	2000
	2.2	4	5.8	B	16	0.12	EEEHB1H2R2R	(1)	2000
	3.3	4	5.8	B	16	0.12	EEEHB1H3R3R	(1)	2000
	4.7	5	5.8	C	23	0.12	EEEHB1H4R7R	(1)	1000
	6.8	5	5.8	C	23	0.12	EEEHB1H6R8R	(1)	1000
	10	6.3	5.8	D	35	0.12	EEEHB1H100P	(1)	1000
	22	8	6.2	E	70	0.12	EEEHB1H220P	(2)	1000
	33	8	10.2	F	91	0.12	EEEHB1H330P	(2)	500
47	10	10.2	G	100	0.12	EEEHB1H470P	(2)	500	

· Please refer to the page of "Reflow Profile" and "The Taping Dimensions".

· When requesting vibration-proof product, please put the last "V" instead to "P"

Characteristics list (Bi-polar)

Endurance : 105 °C 2000 h

Rated voltage (V.DC)	Cap. (±20 %) (μF)	Case size (mm)		Size code	Specification		Part No.	Reflow	Min. Packaging Q'ty
		φD	L		Ripple current (120 Hz) (+105 °C) (mA r.m.s.)	tan δ (120 Hz) (+20 °C)			Taping (pcs)
6.3	47	6.3	5.8	D	35	0.60	EEEHP0J470P	(1)	1000
10	10	4	5.8	B	20	0.44	EEEHP1A100R	(1)	2000
	33	6.3	5.8	D	26	0.44	EEEHP1A330P	(1)	1000
16	10	5	5.8	C	25	0.32	EEEHP1C100R	(1)	1000
25	3.3	4	5.8	B	12	0.28	EEEHP1E3R3R	(1)	2000
	4.7	4	5.8	B	12	0.28	EEEHP1E4R7R	(1)	2000
	10	6.3	5.8	D	28	0.28	EEEHP1E100P	(1)	1000
	22	6.3	5.8	D	55	0.28	EEEHP1E220P	(1)	1000
35	2.2	4	5.8	B	10	0.24	EEEHP1V2R2R	(1)	2000
50	1	4	5.8	B	10	0.24	EEEHP1H1R0R	(1)	2000
	3.3	6.3	5.8	D	16	0.24	EEEHP1H3R3P	(1)	1000
	4.7	6.3	5.8	D	23	0.24	EEEHP1H4R7P	(1)	1000

Characteristics list (5.5 mm max.)

Endurance : 105 °C 2000 h

Rated voltage (V.DC)	Cap. (±20 %) (μF)	Case size (mm)		Size code	Specification		Part No.	Reflow	Min. Packaging Q'ty
		φD	L		Ripple current (120 Hz) (+105 °C) (mA r.m.s.)	tan δ (120 Hz) (+20 °C)			Taping (pcs)
6.3	22	4	5.4	B	26	0.30	EEEHB0J220SR	(1)	2000
	47	5	5.4	C	46	0.30	EEEHB0J470SR	(1)	1000
	100	6.3	5.4	D	71	0.30	EEEHB0J101SP	(1)	1000
10	33	5	5.4	C	43	0.22	EEEHB1A330SR	(1)	1000
16	10	4	5.4	B	28	0.16	EEEHB1C100SR	(1)	2000
	22	5	5.4	C	39	0.16	EEEHB1C220SR	(1)	1000
	47	6.3	5.4	D	70	0.16	EEEHB1C470SP	(1)	1000
25	4.7	4	5.4	B	22	0.14	EEEHB1E4R7SR	(1)	2000
	6.8	4	5.4	B	25	0.14	EEEHB1E6R8SR	(1)	2000
	33	6.3	5.4	D	65	0.14	EEEHB1E330SP	(1)	1000
35	10	5	5.4	C	28	0.12	EEEHB1V100SR	(1)	1000
	22	6.3	5.4	D	55	0.12	EEEHB1V220SP	(1)	1000
50	1	4	5.4	B	10	0.12	EEEHB1H1R0SR	(1)	2000
	2.2	4	5.4	B	16	0.12	EEEHB1H2R2SR	(1)	2000
	3.3	4	5.4	B	16	0.12	EEEHB1H3R3SR	(1)	2000
	4.7	5	5.4	C	23	0.12	EEEHB1H4R7SR	(1)	1000
	6.8	5	5.4	C	23	0.12	EEEHB1H6R8SR	(1)	1000
	10	6.3	5.4	D	35	0.12	EEEHB1H100SP	(1)	1000

· Please refer to the page of "Reflow Profile" and "The Taping Dimensions".

· When requesting vibration-proof product, please put the last "V" instead to "P"

Guidelines and precautions regarding the technical information and use of our products described in this online catalog.

- If you want to use our products described in this online catalog for applications requiring special qualities or reliability, or for applications where the failure or malfunction of the products may directly jeopardize human life or potentially cause personal injury (e.g. aircraft and aerospace equipment, traffic and transportation equipment, combustion equipment, medical equipment, accident prevention, anti-crime equipment, and/or safety equipment), it is necessary to verify whether the specifications of our products fit to such applications. Please ensure that you will ask and check with our inquiry desk as to whether the specifications of our products fit to such applications use before you use our products.
- The quality and performance of our products as described in this online catalog only apply to our products when used in isolation. Therefore, please ensure you evaluate and verify our products under the specific circumstances in which our products are assembled in your own products and in which our products will actually be used.
- If you use our products in equipment that requires a high degree of reliability, regardless of the application, it is recommended that you set up protection circuits and redundancy circuits in order to ensure safety of your equipment.
- The products and product specifications described in this online catalog are subject to change for improvement without prior notice. Therefore, please be sure to request and confirm the latest product specifications which explain the specifications of our products in detail, before you finalize the design of your applications, purchase, or use our products.
- The technical information in this online catalog provides examples of our products' typical operations and application circuits. We do not guarantee the non-infringement of third party's intellectual property rights and we do not grant any license, right, or interest in our intellectual property.
- If any of our products, product specifications and/or technical information in this online catalog is to be exported or provided to non-residents, the laws and regulations of the exporting country, especially with regard to security and export control, shall be observed.



<Regarding the Certificate of Compliance with the EU RoHS Directive/REACH Regulations>

- The switchover date for compliance with the RoHS Directive/REACH Regulations varies depending on the part number or series of our products.
- When you use the inventory of our products for which it is unclear whether those products are compliant with the RoHS Directive/REACH Regulation, please select "Sales Inquiry" in the website inquiry form and contact us.

We do not take any responsibility for the use of our products outside the scope of the specifications, descriptions, guidelines and precautions described in this online catalog.

Looking for pricing, stock, or lifecycle information?

Click below to explore more details on WIN SOURCE:

-  [View **EEE-HB1H100P** on WIN SOURCE](#)
-  [Panasonic Information](#)

Optimize Your Supply Chain with WIN SOURCE Solutions

-  Global Sourcing Solution
-  Obsolete Management
-  Cost Control Management
-  Shortage Management
-  Alternative Solution
-  Excess Inventory Management