

Stacked Metallized PEN Film Chip Capacitor

Series : **ECWU(C)**

Stacked metallized PEN film as dielectric with simple mold-less construction

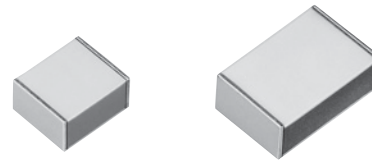

Features

- Small in size
- For reflow soldering
- RoHS directive compliant

Recommended applications

- General purpose (Coupling, By-pass)

Explanation of part number

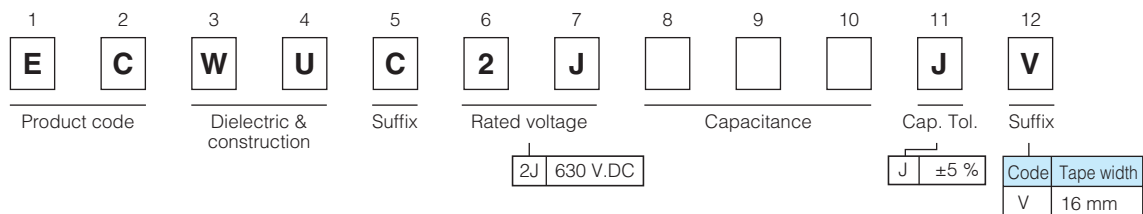
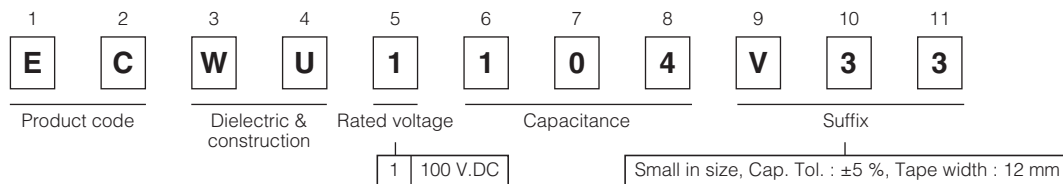
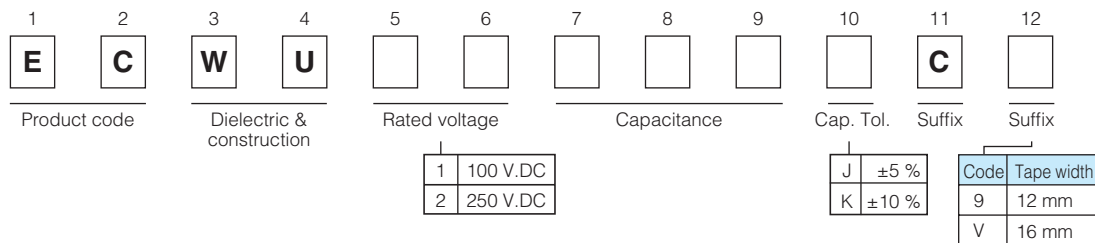

Specifications

Category temp. range (Including temperature-rise on unit surface)	- 55 °C to +125 °C	
Rated voltage	100 V.DC, 250 V.DC, 630 V.DC (Derating of rated voltage by 1.25 %/°C more than 85 °C)	
Capacitance range	100 V.DC	0.012 μF to 1.0 μF (E12)
	250 V.DC	0.0010 μF to 0.12 μF (E12)
	630 V.DC	0.022 μF, 0.027 μF, 0.033 μF
Capacitance tolerance	100 V.DC	±5 %(J), ±10 %(K) (C ≥ 0.18 μF : ±10 %(K) Only)
	250 V.DC	±5 %(J), ±10 %(K)
	630 V.DC	±5 %(J)
Dissipation factor (tan δ)	tan δ ≤ 1.0 % (20 °C, 1 kHz)	
Withstand voltage	Between terminals : Rated volt. (V.DC) × 150 %, 60 s	
Insulation resistance (IR)	C ≤ 0.33 μF	100 V.DC, 250 V.DC, 630 V.DC : IR ≥ 3000 MΩ (20 °C, 100 V.DC, 60 s)
	C > 0.33 μF	100 V.DC : IR ≥ 1000 MΩ·μF (20 °C, 100 V.DC, 60 s)
Soldering conditions	100 V.DC	Reflow soldering : 250 °C max. and 60 s max. at more than 220 °C
	250 V.DC	(Temp. at capacitor surface)
	630 V.DC	Reflow soldering : 250 °C max. and 60 s to 150 s. at more than 217 °C (Temp. at cap. surface)

* In case of applying voltage in alternating current (50 Hz or 60 Hz sine wave) to a capacitor with DC rated voltage, please refer to the page of "Permissible voltage (R.M.S) in alternating current corresponding to DC rated voltage".

* Please consult us for capacitance range between 0.15 μF and 1.0 μF. (250 V.DC)

Construction

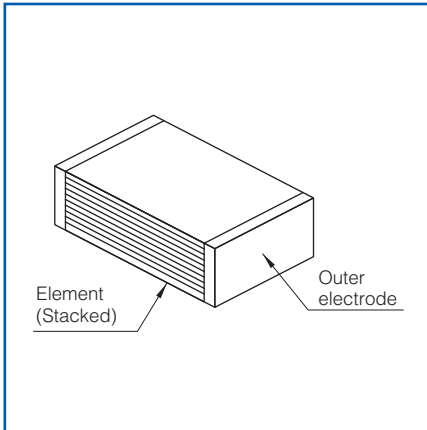

Dimensions

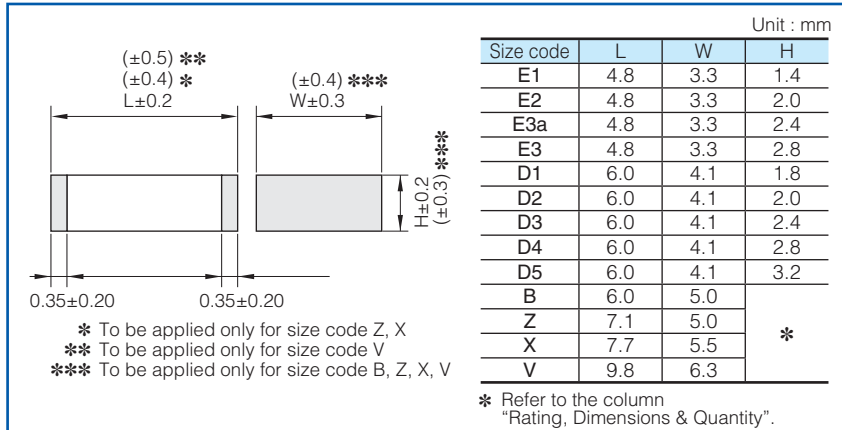

Taping specification for automatic mounting

Refer to the page of taping specifications

Rating · Dimensions · Quantity

● Capacitance tolerance : $\pm 5\%$ (J), $\pm 10\%$ (K)

Capacitance (μF)	Rated voltage 100 V.DC						Rated voltage 250 V.DC					
	Part No.	Dimensions (mm)			Size code	Q'ty	Part No.	Dimensions (mm)			Size code	Q'ty
		L	W	H				L	W	H		
0.0010						ECWU2102□C9	4.8	3.3	1.4	E1	3000	
0.0012						ECWU2122□C9	4.8	3.3	1.4	E1		
0.0015						ECWU2152□C9	4.8	3.3	1.4	E1		
0.0018						ECWU2182□C9	4.8	3.3	1.4	E1		
0.0022						ECWU2222□C9	4.8	3.3	1.4	E1		
0.0027						ECWU2272□C9	4.8	3.3	1.4	E1		
0.0033						ECWU2332□C9	4.8	3.3	1.4	E1		
0.0039						ECWU2392□C9	4.8	3.3	1.4	E1		
0.0047						ECWU2472□C9	4.8	3.3	1.4	E1		
0.0056						ECWU2562□C9	4.8	3.3	1.4	E1		
0.0068						ECWU2682□C9	4.8	3.3	1.4	E1		
0.0082						ECWU2822□C9	4.8	3.3	1.4	E1		
0.010						ECWU2103□C9	4.8	3.3	1.4	E1		
0.012	ECWU1123□C9	4.8	3.3	1.4	E1	ECWU2123□C9	4.8	3.3	1.4	E1		2000
0.015	ECWU1153□C9	4.8	3.3	1.4	E1	ECWU2153□C9	4.8	3.3	1.4	E1		
0.018	ECWU1183□C9	4.8	3.3	1.4	E1	ECWU2183□C9	4.8	3.3	2.0	E2		
0.022	ECWU1223□C9	4.8	3.3	1.4	E1	ECWU2223□C9	4.8	3.3	2.0	E2		
0.027	ECWU1273□C9	4.8	3.3	1.4	E1	ECWU2273□C9	4.8	3.3	2.4	E3a		
0.033	ECWU1333□C9	4.8	3.3	1.4	E1	ECWU2333□C9	4.8	3.3	2.8	E3		
0.039	ECWU1393□C9	4.8	3.3	1.4	E1	ECWU2393□C9	6.0	4.1	2.0	D2		
0.047	ECWU1473□C9	4.8	3.3	2.0	E2	ECWU2473□C9	6.0	4.1	2.4	D3		
0.056	ECWU1563□C9	4.8	3.3	2.0	E2	ECWU2563□C9	6.0	4.1	2.8	D4		
0.068	ECWU1683□C9	4.8	3.3	2.4	E3a	ECWU2683□C9	6.0	4.1	3.2	D5		
0.082	ECWU1823□C9	4.8	3.3	2.8	E3	ECWU2823□C9	6.0	5.0	3.2	B		
0.10	ECWU1104□C9	6.0	4.1	1.8	D1	ECWU2104□C9	6.0	5.0	3.8	B	1500	
	ECWU1104V33	4.8	3.3	2.8	E3							
0.12	ECWU1124□C9	6.0	4.1	2.4	D3	ECWU2124□C9	6.0	5.0	4.5	B		
0.15	ECWU1154□C9	6.0	4.1	2.8	D4							
0.18	ECWU1184KC9	7.1	5.0	2.0	Z							
0.22	ECWU1224KC9	7.1	5.0	2.4	Z							
0.27	ECWU1274KC9	7.1	5.0	2.9	Z							
0.33	ECWU1334KC9	7.1	5.0	3.5	Z							
0.39	ECWU1394KCV	7.7	5.5	3.4	x							
0.47	ECWU1474KCV	7.7	5.5	4.0	x							
0.56	ECWU1564KCV	9.8	6.3	3.0	V							
0.68	ECWU1684KCV	9.8	6.3	3.6	V							
0.82	ECWU1824KCV	9.8	6.3	4.3	V							
1.0	ECWU1105KCV	9.8	6.3	5.1	V							

* □ : Capacitance tolerance

Rating · Dimensions · Quantity

- Capacitance tolerance : $\pm 5\%$ (J)

Capacitance (μF)	Rated voltage 630 V.DC					Size code	Q'ty
	Part No.	Dimensions (mm)					
		L	W	H			
0.022	ECWUC2J223JV	7.1	6.3	3.6	Y	1000	
0.027	ECWUC2J273JV	7.1	6.3	4.1	Y		
0.033	ECWUC2J333JV	7.1	6.3	5.1	Y		

Recommended for land dimensions

Unit : mm

Size code	Land dimensions		
	Reflow soldering		
	A	B	C
E1, E2, E3a, E3	2.6	6.6	3.0
D1, D2, D3, D4, D5	3.8	7.8	3.8
B	3.8	7.8	4.6
Z	4.5	9.0	4.6
Y	4.5	9.0	5.7
X	5.1	9.7	5.0
V	7.2	11.9	5.7

* It is not warrantable that you can mount the capacitor without trouble under all the mounting condition when "Recommender for Land dimensions" is adopted.

Guidelines and precautions regarding the technical information and use of our products described in this online catalog.

- If you want to use our products described in this online catalog for applications requiring special qualities or reliability, or for applications where the failure or malfunction of the products may directly jeopardize human life or potentially cause personal injury (e.g. aircraft and aerospace equipment, traffic and transportation equipment, combustion equipment, medical equipment, accident prevention, anti-crime equipment, and/or safety equipment), it is necessary to verify whether the specifications of our products fit to such applications. Please ensure that you will ask and check with our inquiry desk as to whether the specifications of our products fit to such applications use before you use our products.
- The quality and performance of our products as described in this online catalog only apply to our products when used in isolation. Therefore, please ensure you evaluate and verify our products under the specific circumstances in which our products are assembled in your own products and in which our products will actually be used.
- If you use our products in equipment that requires a high degree of reliability, regardless of the application, it is recommended that you set up protection circuits and redundancy circuits in order to ensure safety of your equipment.
- The products and product specifications described in this online catalog are subject to change for improvement without prior notice. Therefore, please be sure to request and confirm the latest product specifications which explain the specifications of our products in detail, before you finalize the design of your applications, purchase, or use our products.
- The technical information in this online catalog provides examples of our products' typical operations and application circuits. We do not guarantee the non-infringement of third party's intellectual property rights and we do not grant any license, right, or interest in our intellectual property.
- If any of our products, product specifications and/or technical information in this online catalog is to be exported or provided to non-residents, the laws and regulations of the exporting country, especially with regard to security and export control, shall be observed.



<Regarding the Certificate of Compliance with the EU RoHS Directive/REACH Regulations>

- The switchover date for compliance with the RoHS Directive/REACH Regulations varies depending on the part number or series of our products.
- When you use the inventory of our products for which it is unclear whether those products are compliant with the RoHS Directive/REACH Regulation, please select "Sales Inquiry" in the website inquiry form and contact us.

We do not take any responsibility for the use of our products outside the scope of the specifications, descriptions, guidelines and precautions described in this online catalog.

Looking for pricing, stock, or lifecycle information?

Click below to explore more details on WIN SOURCE:

-  [View ECW-U2224KCV](#) on WIN SOURCE
-  [Panasonic](#) Information

Optimize Your Supply Chain with WIN SOURCE Solutions

-  Global Sourcing Solution
-  Obsolete Management
-  Cost Control Management
-  Shortage Management
-  Alternative Solution
-  Excess Inventory Management