



**THE DATASHEET OF
ECS-40-20-5G3XDS-TR**



The CSM-7X-3L is a low profile SMD Crystal with 3rd lead, and is ideal for applications that require a case ground

CSM-7X-3L SMD CRYSTAL

Request a Sample



- Cost Effective
- Case Ground
- Extended Temp. Range Option
- Pb Free/RoHS Compliant

OPERATING CONDITIONS / ELECTRICAL CHARACTERISTICS

PARAMETERS	CONDITIONS	CSM-7X-3L			UNITS
		MIN	TYP	MAX	
Frequency		3.57		70.000	MHz
Frequency Tolerance*	@ +25°C			± 30	ppm
Frequency Stability*	-10 ~ +70°C			± 50	ppm
Shunt Capacitance	Co			7	pF
Load Capacitance	Specify in P/N	10	20	Series	pF
Drive Level	DL			500	μW
Operating Temperature*	Topr	-10		+70	°C
Storage Temperature	Tstg	-55		+125	°C
Aging (First Year)	@ +25°C ±3°C			±5	ppm

DIMENSIONS (mm)

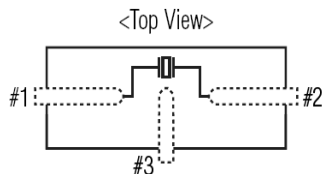
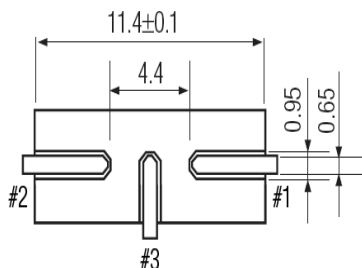
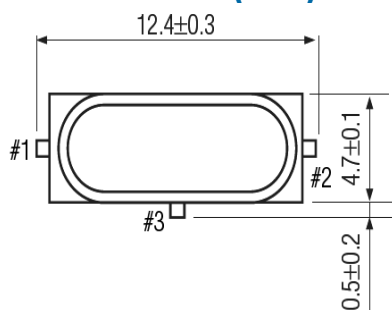

Frequency (MHz)	ESR Ω Max.	Mode of Osc.
3.57 ~ 4.999	150	Fundamental
5.000 ~ 5.999	80	Fundamental
6.000 ~ 6.999	70	Fundamental
7.000 ~ 8.999	60	Fundamental
9.000 ~ 12.999	50	Fundamental
13.000 ~ 19.999	40	Fundamental
20.000 ~ 30.000	30	Fundamental
30.100 ~ 39.999	100	3 rd Overtone
40.000 ~ 70.000	80	3 rd Overtone

Pad Connections	
1	In/Out
2	Out/In
3	Gnd

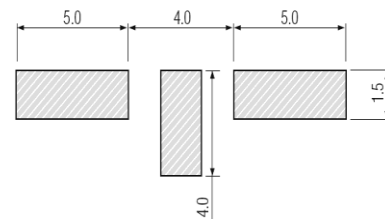

Figure 1) Top, Side, and Bottom

Crystal is symmetrical, pin 1 & 2 are interchangeable.

Figure 2) Suggested land

PART NUMBERING GUIDE: Example ECS-200-20-5G3XDS-TR

ECS - FREQUENCY ABBREVIATION	LOAD CAPACITANCE	PACKAGE	AVAILABLE OPTIONS			PACKAGING	
			Tolerance	Stability	Temp Range		
ECS	200 = 20.000 MHz See P/N Guide	20 = 20 pF S = Series	5G3X = CSM-7X-3L	Blank = Std A = ± 25 ppm J = ± 20 ppm R = ± 15 ppm C = ± 10 ppm	Blank = Std D = ± 100 ppm E = ± 50 ppm G = ± 30 ppm H = ± 25 ppm T = ± 20 ppm † W = ± 15 ppm † K = ± 10 ppm †	Blank = Std L = -10 ~ +70°C M = -20 ~ +70°C Y = -30 ~ +85°C N = -40 ~ +85°C P = -40 ~ +105°C S = -40 ~ +125°C U = -55 ~ +125°C	TR = Tape & Reel 1K/Reel

* Specify available options in P/N.

† Contact ECS for availability over extended temp range.

Rev.2017

POCKET TAPE DIMENSIONS (mm)

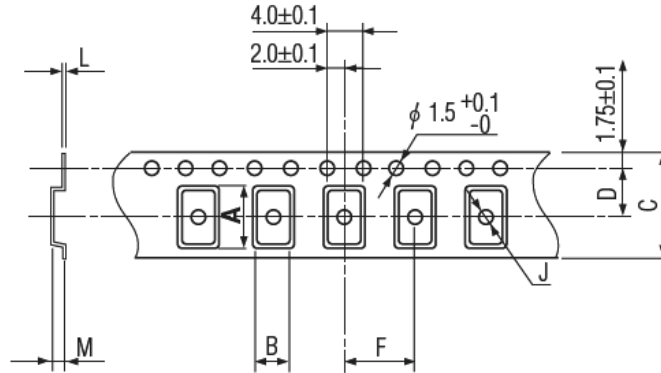

A	B	C	D	F	J	L	M	Reel Dia.	Qty/Reel
14.0	5.0	24.0	11.5	8.0	1.5	0.4	4.4	330	1000pcs

SOLDER PROFILE

Peak solder Temp +260°C Max 10 sec Max.

2 Cycles Max.

MSL 1, Lead Finish Sn/Cu Matte

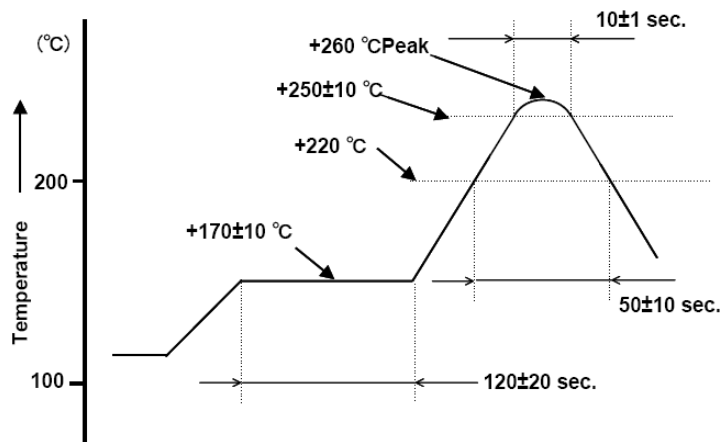



Figure 1) Suggested Reflow Profile

Looking for pricing, stock, or lifecycle information?

Click below to explore more details on WIN SOURCE:

-  [View ECS-40-20-5G3XDS-TR on WIN SOURCE](#)
-  [ECS Inc. Information](#)

Optimize Your Supply Chain with WIN SOURCE Solutions

-  Global Sourcing Solution
-  Obsolete Management
-  Cost Control Management
-  Shortage Management
-  Alternative Solution
-  Excess Inventory Management