



**THE DATASHEET OF
ECC-T3F330JG2**



High Voltage Ceramic Capacitors For Surface Mounting 1 to 5 kVDC



■ Features

- Resin molded SMD type for reflow solderings
- High reliability through use of disc capacitor element
- Wide rated voltage ranges from 1 kV to 5 kV, through a disc element which withstand high voltage and outcurve terminals
- Wide rated voltage range 1 to 5 kV

■ Recommended Application

- Ballast circuit of LCD backlighting inverter (For 3 to 5 kVDC Char.SL/GP)
- Snubber circuit of switching power supply (For 1 to 2 kVDC Char.B/Y5P)

■ Explanation of Part Numbers

1		2		3		4		5		6		7		8		9		10		11		12					
E		C		C		T		3		F		4		7		0		J		G							
Product Code				Packaging Style				Rated Voltage				Nominal Capacitance				Cap. Tolerance				Temp. Char.				Suffix			
Code		Class		Code		Style		Code		Rated Voltage		Ex.		Capacitance		Code		Tol.		Code		Temp. Char.		Code		Style code	
ECC		Class1		T		Taped type		3A		1 kVDC		100		10 pF		D		±0.5 pF		G		SL/GP		Nil		1	
ECK		Class2						3D		2 kVDC		470		47 pF		J		±5 %		B		B/Y5P		M		2	
								3F		3 kVDC		101		100 pF		K		±10 %						2		3	
								3G		4 kVDC		221		220 pF		M		±20 %						Y		4	
								3H		5 kVDC																	

■ Construction

- Inside Terminal



■ Dimensions in mm (not to scale)

- style 1, 3

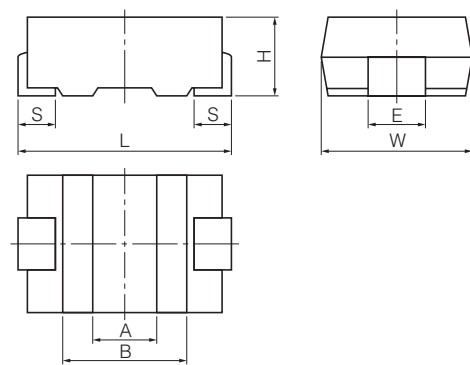

- Outside Terminal

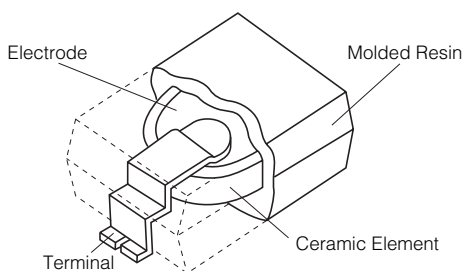

- style 2, 4

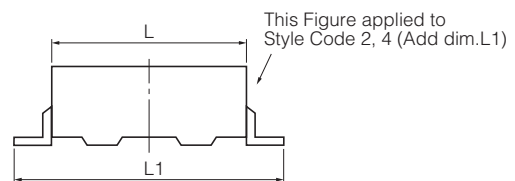

Symbol	L1	L	W	H	S	E	A	B
Style 1	—	7.1±0.5	6.3±0.3	2.5±0.3	1.45±0.30	2.5±0.2	(2.0)	(3.7)
Style 2	10.8±0.5	6.8±0.5	6.3±0.3	2.5±0.3	—	2.5±0.2	(2.0)	(3.7)
Style 3	—	5.7±0.5	4.5±0.3	2.3max.	0.85±0.30	2.5±0.2	(1.7)	(3.1)
Style 4	9.4±0.3	5.5±0.5	4.5±0.3	2.3±0.2	—	2.5±0.2	(1.7)	(3.1)

Specifications

Characteristics	Char. SL/GP			Char. B/Y5P
Operating Temperature Range	-25 to 105 °C			
Rated Voltage	2 to 3 kVDC	4 to 5 kVDC	5 kVDC	1 to 2 kVDC
Dielectric Withstanding Voltage	200 % of Rated Voltage for 1 to 5 seconds	150 % of Rated Voltage for 1 to 5 seconds	120 % of Rated Voltage for 1 to 5 seconds	200 % of Rated Voltage for 1 to 5 seconds
Capacitance	Within the specified tolerance, when measured at 1 MHz±20 %, 1 to 5 Vrms. and 20 °C			Within the specified tolerance, when measured at 1 kHz±20 %, 1 to 5 Vrms. and 20 °C
Q or Dissipation Factor (tan δ)	30 pF or under Q ≥ 400+20 C (C:Cap.pF) over 30 pF Q ≥ 1000 at 1 MHz±20 %, 1 to 5 Vrms. and 20 °C			tan δ ≤ 0.025 at 1 kHz±20 %, 1 to 5 Vrms. and 20 °C
Insulation Resistance	10000 M Ω min. at 500 VDC and 1 minute electrification			
Temperature Characteristics	Temperature Coefficient: +350 to -1000 ppm/ °C (Temperature Range : 20 to 85 °C)			Max. Cap. Change:±10 % (Temperature Range : -25 to 85 °C)

Packaging Methods (Taping)

Minimum Quantity/Packing Unit

Type	Packaging Style	Part Number		Minimum Packing Quantity	Packing Quantity in Carton	Carton Dimensions in mm LxWxH
1 to 5 kVDC (style 1)	Embossed Carrier Taping	EC□T3□□□□□□□□	5 to 470 pF	2000 pcs./reel	6000 pcs.	350×350×62
5 kVDC (style 2)	Embossed Carrier Taping	ECCT3H□□□□□□M	5 to 27 pF	2000 pcs./reel	4000 pcs.	350×350×62
4 kVDC (style 3)	Embossed Carrier Taping	ECCT3G□□□□JG2	10 to 27 pF	3000 pcs./reel	9000 pcs.	350×350×62
5 kVDC (style 4)	Embossed Carrier Taping	ECCT3H□□□□□□Y	5 to 15 pF	3000 pcs./reel	6000 pcs.	350×350×62

Reel

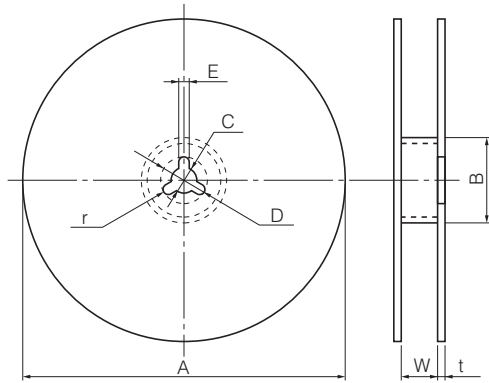

Unit:(mm)

Symbol	A	B	C	D	E	W	t	r	
Dim. (mm)	style 1, 3	330±5	60 min.	13.0±0.5	21.0±1.0	2.0±0.5	13.5±1.5	R1.0	
	style 2								25.5±1.5
	style 4								17.5±1.5

Embossed Carrier Taping

style 1, 3, 4

(W=12 mm)

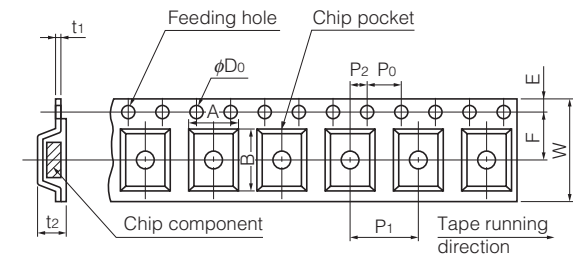

style 2

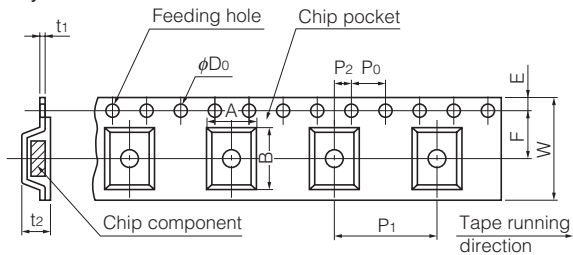

Unit:(mm)

Symbol	A	B	W	F	E	P ₁	P ₂	P ₀	φD ₀	t ₁	t ₂	
Dim. (mm)	style1	6.5±0.2	7.5±0.2	12.0±0.3	5.5±0.1	1.75±0.10	8.0±0.1	2.0±0.1	4.0±0.1	1.5 ^{+0.1} ₋₀	0.3±0.1	3.2±0.3
	style2	6.65±0.20	11.2±0.2	24.0±0.3	11.5±0.1	1.75±0.10	12.0±0.1	2.0±0.1	4.0±0.1	1.5 ^{+0.1} ₋₀	0.3±0.1	3.2±0.3
	style3	4.8±0.2	6.0±0.2	12.0±0.3	5.5±0.1	1.75±0.10	8.0±0.1	2.0±0.1	4.0±0.1	1.5 ^{+0.1} ₋₀	0.3±0.1	2.8±0.3
	style4	4.7±0.2	10.0±0.5	16.0±0.3	7.5±0.1	1.75±0.10	8.0±0.1	2.0±0.1	4.0±0.1	1.5 ^{+0.1} ₋₀	0.3±0.1	2.85±0.30

● Leader Part and Taped End



■ Ratings and Characteristics

● Rated Voltage 1 to 5 kVDC

Rated Voltage	Part Number	Capacitance (pF)	Cap. Tolerance (%)	Temp. Char	Style
5 kVDC	ECCT3H050DGM	5	±0.5 pF	SL/GP	Style 2
	ECCT3H100JGM	10	±5	SL/GP	
	ECCT3H120JGM	12	±5	SL/GP	
	ECCT3H150JGM	15	±5	SL/GP	
	ECCT3H180JGM	18	±5	SL/GP	
	ECCT3H220JGM	22	±5	SL/GP	
	ECCT3H270JGM	27	±5	SL/GP	Style 4
	ECCT3H050DGY	5	±0.5 pF	SL/GP	
	ECCT3H080DGY	8	±0.5 pF	SL/GP	
	ECCT3H100JGY	10	±5	SL/GP	
	ECCT3H120JGY	12	±5	SL/GP	
	ECCT3H150JGY	15	±5	SL/GP	
4 kVDC	ECCT3G100DG2	10	±0.5 pF	SL/GP	Style 3
	ECCT3G120JG2	12	±5	SL/GP	
	ECCT3G150JG2	15	±5	SL/GP	
	ECCT3G180JG2	18	±5	SL/GP	
	ECCT3G220JG2	22	±5	SL/GP	
	ECCT3G270JG2	27	±5	SL/GP	
	ECCT3G330JG	33	±5	SL/GP	Style 1
	ECCT3G390JG	39	±5	SL/GP	
	ECCT3G470JG	47	±5	SL/GP	
3 kVDC	ECCT3F100DG2	10	±0.5 pF	SL/GP	Style 3
	ECCT3F120JG2	12	±5	SL/GP	
	ECCT3F150JG2	15	±5	SL/GP	
	ECCT3F180JG2	18	±5	SL/GP	
	ECCT3F220JG2	22	±5	SL/GP	
	ECCT3F270JG2	27	±5	SL/GP	
	ECCT3F330JG2	33	±5	SL/GP	
	ECCT3F390JG	39	±5	SL/GP	
	ECCT3F470JG	47	±5	SL/GP	
2 kVDC	ECCT3D680JG	68	±5	SL/GP	Style 1
	ECKT3D101KB	100	±10	B/Y5P	
	ECKT3D121KB	120	±10	B/Y5P	
	ECKT3D151KB	150	±10	B/Y5P	
	ECKT3D181KB	180	±10	B/Y5P	
	ECKT3D221KB	220	±10	B/Y5P	
	ECKT3D271KB	270	±10	B/Y5P	
	ECKT3D331KB	330	±10	B/Y5P	
1 kVDC	ECKT3A391KB	390	±10	B/Y5P	Style 1
	ECKT3A471KB	470	±10	B/Y5P	

Notes * This part number indicates taped type.
* Capacitance 9 pF or under is available by special order.

Design and specifications are each subject to change without notice. Ask factory for the current technical specifications before purchase and/or use. Should a safety concern arise regarding this product, please be sure to contact us immediately.

■ Typical Characteristics

● Temperature Characteristics

Char. SL/GP
(Temp.Coeff.: +350 to -1000 ppm/°C)



Char. B/Y5P
(Temp.Range: -25 to 85 °C)
(max.Cap.Change: ±10 %)

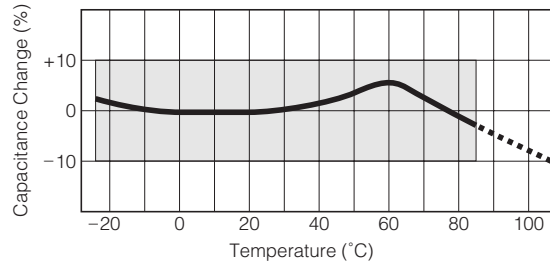

● Characteristics of Voltage-Frequency

Rated Voltage 3 kVDC

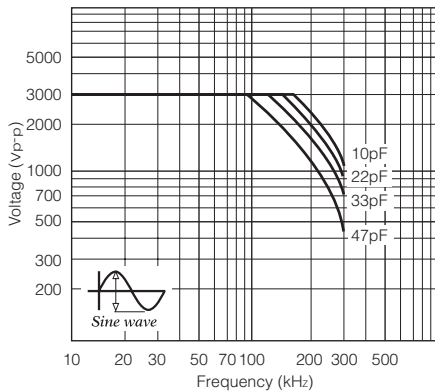

Rated Voltage 4 kVDC

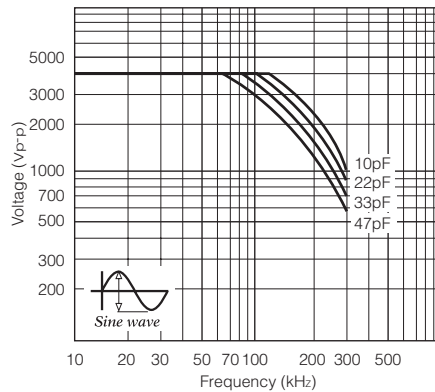

Rated Voltage 5 kVDC

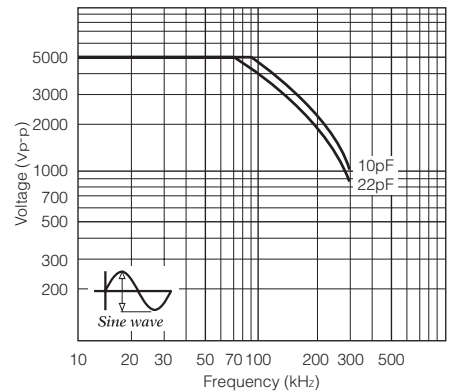

The graphs above show the maximum permissible voltage when using a capacitor with an AC sine wave voltage.

When measuring this voltage in room temperature (25 °C), the capacitor self-heat generation will rise a maximum of 20 °C.

When using a pulse voltage or an AC voltage other than a sine wave, confirm that the capacitor self-heat generation is less than 20 °C in an ambient room temperature of 25 °C.

The self-heat generation temperature is the difference between the surface temperature and the ambient room temperature.

As for the situation when the self-heat generation temperature is more than 25 °C, refer to the figure on the right.

Permission self generation of heat temperature vs. ambient temperature

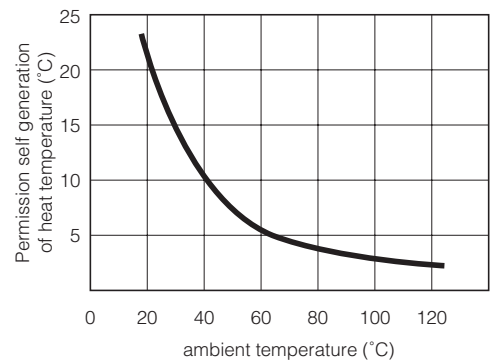

■ Application Examples

● LCD Backlighting Inverter



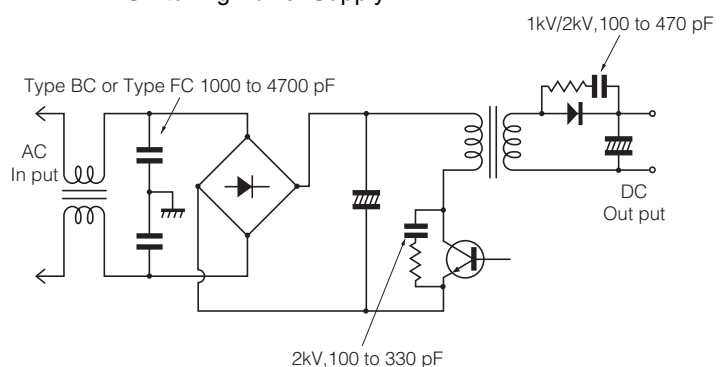

● Primary circuit and Snubber circuit of Switching Power Supply



Looking for pricing, stock, or lifecycle information?

Click below to explore more details on WIN SOURCE:

-  [View ECC-T3F330JG2](#) on WIN SOURCE
-  [Panasonic](#) Information

Optimize Your Supply Chain with WIN SOURCE Solutions

-  Global Sourcing Solution
-  Obsolete Management
-  Cost Control Management
-  Shortage Management
-  Alternative Solution
-  Excess Inventory Management