



**THE DATASHEET OF
DU1352-4R7M**



Series Number
DU6629
DU1330
DU1352
DU1311
DU1971



3003 9th Avenue SW
 PO Box 50
 Watertown, SD 57201
 Toll free: 888-978-2638
 Ph: 605-886-3326
 Fax: 605-886-8995



SMD Unshielded Power Inductor Series; Part Numbering Sequence: (Series Number) - (Suffix Code)(Tolerance), example DU1330-220M
 Bulk Packaging add (-B) to end of Part Numbering Sequence. example DU1330-220M-B

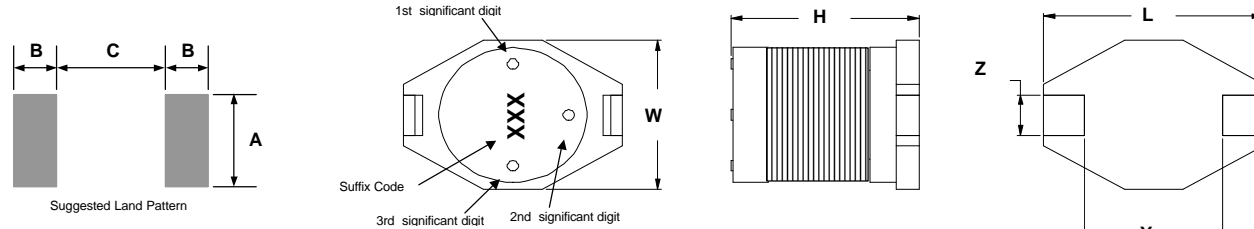

Parts will be marked with Significant Digit Dots OR Suffix code

Series Number	Units	Maximum Dimensions			Nominal Dimensions						
		L	W	H	Y	Z	A	B	C		
DU6629	inches	0.260"	0.177"	0.115"	0.190"	0.050"	0.140"	0.055"	0.160"		
	[mm]	[6.60]	[4.50]	[2.92]	[4.83]	[1.27]	[3.56]	[1.40]	[4.06]		
DU1330	inches	0.510"	0.370"	0.130"	0.300"	0.100"	0.110"	0.115"	0.290"		
	[mm]	[12.95]	[9.40]	[3.30]	[7.62]	[2.54]	[2.79]	[2.92]	[7.37]		
DU1352	inches	0.510"	0.370"	0.205"	0.300"	0.100"	0.110"	0.115"	0.290"		
	[mm]	[12.95]	[9.40]	[5.21]	[7.62]	[2.54]	[2.79]	[2.92]	[7.37]		
DU1311	inches	0.510"	0.370"	0.450"	0.300"	0.100"	0.110"	0.115"	0.290"		
	[mm]	[12.95]	[9.40]	[11.43]	[7.62]	[2.54]	[2.79]	[2.92]	[7.37]		
DU1971	inches	0.730"	0.600"	0.291"	0.500"	0.100"	0.110"	0.115"	0.490"		
	[mm]	[18.54]	[15.24]	[7.40]	[12.70]	[2.54]	[2.79]	[2.92]	[12.45]		

Features:

- High energy storage and low resistance
- Ideal for DC-DC step-up or step-down conversion
- Reliable surface mounting, flat top for pick and place
- Robust temperature deflection to prevent damage during solder reflow
- Drop in replacements for industry prevalent competitor series
- Operating temperature -40°C to +85°C

L ¹ µH	Suffix Codes	DU6629				DU1330				DU1352				DU1311				DU1971				Significant Digit		
		DCR ²	I _{SAT} ³	I _{RMS} ⁵	Tolerance	DCR ²	I _{SAT} ³	I _{RMS} ⁵	Tolerance	DCR ²	I _{SAT} ³	I _{RMS} ⁶	Tolerance	DCR ²	I _{SAT} ³	I _{RMS} ⁷	Tolerance	DCR ²	I _{SAT} ³	I _{RMS} ⁷	Tolerance	Dot Code		
		W	A	A	Suffix ⁴	W	A	A	Suffix ⁴	W	A	A	Suffix ⁴	W	A	A	Suffix ⁴	W	A	A	Suffix ⁴	1st	2nd	3rd
1.0	1R0	0.050	2.90	2.90	M					0.0092	9.00	6.80	M					0.009	20.00	8.60	M	BRN	BLK	RED
1.5	1R5	0.050	2.60	2.80	M					0.0104	8.00	6.40	M											
2.2	2R2	0.070	2.30	2.40	M					0.0120	7.00	6.10	M					0.014	16.00	7.10	M	RED	RED	RED
3.3	3R3	0.080	2.00	2.00	M					0.0150	6.40	5.40	M					0.018	14.00	6.20	M	ORG	GRN	RED
4.7	4R7	0.090	1.50	1.50	M					0.0184	5.40	4.80	M											
5.6	5R6																							
6.8	6R8	0.130	1.20	1.40	M					0.0270	4.60	4.40	M	0.015	10.00	5.00	M	0.020	12.00	5.30	M	GRN	BLU	RED
8.0	8R0													0.022	9.50	4.00	M							
10	100	0.160	1.10	1.30	M	0.110	2.40	2.00	M	0.0380	3.80	3.90	M	0.040	8.00	3.50	M	0.031	10.00	4.30	M	BRN	BLK	ORG
15	150	0.230	0.90	1.20	M	0.150	2.00	1.50	M	0.0460	3.00	3.10	M	0.050	7.00	3.00	M	0.036	8.00	4.00	M	BRN	GRN	ORG
22	220	0.370	0.70	0.80	M	0.230	1.60	1.30	M	0.0850	2.60	2.70	M	0.070	5.50	2.50	M	0.047	7.00	3.50	M	RED	RED	ORG
33	330	0.510	0.58	0.60	M	0.300	1.40	1.10	M	0.1012	2.00	2.10	M	0.080	4.00	2.00	M	0.066	5.50	3.00	M	ORG	ORG	ORG
47	470	0.640	0.50	0.50	M	0.390	1.00	0.80	M	0.1400	1.60	1.80	M	0.110	3.80	1.60	M	0.086	4.50	2.60	M	YEL	VIO	ORG
68	680	0.860	0.40	0.40	M	0.660	0.90	0.70	M	0.2000	1.40	1.50	M	0.170	3.00	1.20	M	0.130	3.50	2.30	M	BLU	GRY	ORG
100	101	1.270	0.31	0.30	M	0.840	0.70	0.60	M	0.2800	1.20	1.30	M	0.220	2.50	1.20	M	0.190	3.00	1.80	M	BRN	BLK	YEL
150	151	2.000	0.27	0.25	M	1.200	0.60	0.50	M	0.4000	1.00	1.00	M	0.340	2.00	0.90	M	0.250	2.60	1.50	M	BRN	GRN	YEL
220	221	3.110	0.22	0.20	M	1.900	0.50	0.40	M	0.6100	0.80	0.80	M	0.440	1.60	0.70	M	0.380	2.40	1.20	M	RED	RED	YEL
330	331	4.800	0.18	0.16	M	2.700	0.40	0.30	M	1.0200	0.60	0.60	M	0.700	1.20	0.60	M	0.560	1.90	1.00	M	ORG	ORG	YEL
470	471	6.800	0.16	0.15	M	4.000	0.30	0.20	M	1.2700	0.50	0.50	M	0.950	1.00	0.30	M	0.850	1.40	0.82	M	YEL	VIO	YEL
680	681	9.200	0.10	0.12	M	5.300	0.20	0.10	M	2.0200	0.40	0.40	M	1.200	1.00	0.20	M	1.100	1.20	0.72	M	BLU	GRY	YEL
1000	102	13.800	0.10	0.07	M	8.400	0.10	0.05	M	3.0000	0.30	0.30	M	2.000	0.80	0.10	M	1.800	1.00	0.56	M	BRN	BLK	GRN

1) Tested at 100kHz, 100mVrms @20°C
 2) DCRs (DC resistances) are maximums @20°C.
 3) DC (Direct Current) current applied to produce a typical 10% drop in inductance.
 4) Suffix of M=20%
 5) Current applied to produce a typical 30°C temperature rise from nominal inductance.
 6) Current applied to produce a typical 15°C temperature rise from nominal inductance.
 7) Current applied to produce a typical 40°C temperature rise from nominal inductance.

Specifications subject to change without notice.

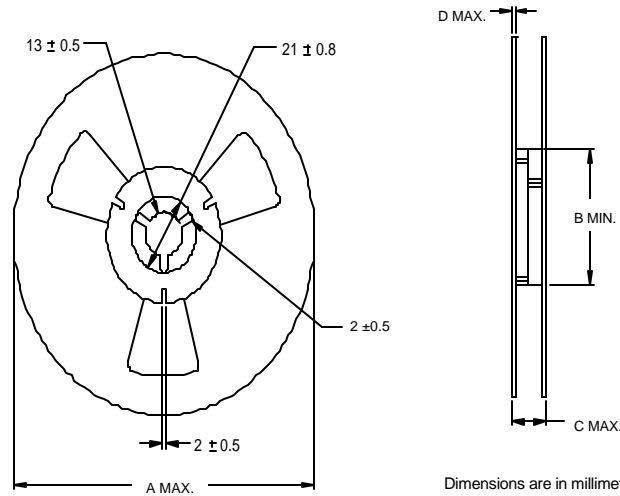

Dimensions are in millimeters unless specified.

Series Number	Reel dimensions					Reel Qty	Packaging Specification
	Units	A	B	C	D		
DU6629	in.	12.99"	3.94"	0.88"	0.094"	2500	90-0057
	[mm]	[360]	[100.0]	[22.4]	[2.40]		
DU1330	in.	14.17"	3.94"	0.88"	0.094"	1000	90-0058
	[mm]	[360]	[100.0]	[22.4]	[2.40]		
DU1352	in.	14.17"	3.94"	0.88"	0.094"	700	90-0059
	[mm]	[360]	[100.0]	[22.4]	[2.40]		
DU1311	in.	14.17"	3.94"	0.88"	0.094"	250	90-0060
	[mm]	[360]	[100.0]	[22.4]	[2.40]		
DU1971	in.	14.17"	3.94"	0.88"	0.094"	250	90-0065
	[mm]	[360]	[100.0]	[22.4]	[2.40]		

PACKAGING NOTE: Only pressure sensitive cover tape is to be used.

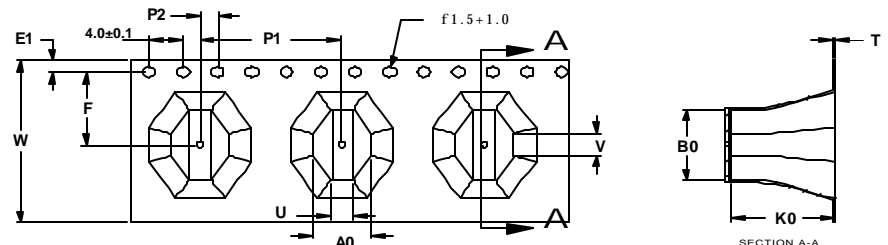

Series	A0 ± 0.1	U ± 0.1	V ± 0.1	P1 ± 0.1	P2 ± 0.1	W ± 0.3	F ± 0.1	E1 MIN.	B0 ± 0.1	K0 ± 0.05	T ± 0.05
DU6629	4.55	1.45	2.70	8.00	2.00	16.00	5.5 ± 0.05	1.75	6.70	3.45	0.35
DU1330	9.50	3.90	4.00	12.00	2.00	24.00	11.50	1.75	13.10	3.10	0.35
DU1352	9.50	3.90	4.00	12.00	2.00	24.00	11.50	1.75	13.10	5.30	0.35
DU1311	10.20	3.90	4.00	12.00	2.00	24.00	11.50	1.75	13.10	11.60	0.35
DU1971	15.40	5.80	6.00	20.00	2.00	32.00	14.20	1.75	18.84	7.20	0.35

Customer Packaging Specifications
For Print Distribution to Customers



Series	Revision
DU SERIES	C
Sheet 2 of 3	

Item	Specification	Test Method/Condition
Environmental		
Static Humidity	After exposure part remains within specified electrical parameters for L, Q and DCR.	Expose parts to an environment of +50°C with 90 to 95% R.H. for 100 hours. After exposure, allow parts to dry for 2 hours before measurements are taken.
Storage Life	After exposure part remains within specified electrical parameters for L, Q and DCR.	Subject parts to an environment of +50°C 90 to 100% R.H. for 46 to 50 hours. After exposure, allow parts to dry for 2 hours before measurements are taken.
Moisture Resistance	After exposure, part shall not have a shorted or open winding.	Per MIL-STD 202 Method 106, ten 24 hour cycles at +25°C to +65°C at 80 to 95% R.H. During any of the first 9 cycles, inductors are revolved from the chamber and exposed to -10°C for 3 hours. Allow parts to dry for 2 hours before measurements are taken.
Temperature Cycle	After exposure part remains within specified electrical parameters for L, Q and DCR.	10 cycles (Air to Air) 1 cycle shall consist of: 30 minutes exposure to +85°C 30 minutes exposure to -40°C Allow 20 minutes transition between extremes.
Temperature Shock	After exposure part remains within specified electrical parameters for L, Q and DCR.	10 cycles (Air to Air) 1 cycle shall consist of: 30 minutes exposure to -45°C 30 minutes exposure to +125°C 15 seconds maximum transition between temperatures
General		
Storage Temperature Range	-40°C to +85°C	
Operating Temperature Range	-40°C to +85°C	
Flammability	IEC 695-2-2	Withstands needle-flame test
Other		
Vibration	After exposure part remains within specified electrical parameters for L, Q and DCR.	Inductors shall be randomly vibrated per NAVMAT P9492 profile. Samples shall be subjected to 0.04G/Hz for a minimum of 15 minutes per axis, for each of the three axes.
Mechanical Shock	After exposure part remains within specified electrical parameters for L, Q and DCR.	Test per MIL-STD 202 method 213 test condition A, test mounted samples 3 axes, 6 times, totaling 18 shocks. (50Gs, 11ms, half-sine).
Solderability	Wetting shall cover 90% minimum of each termination	Dip pads in RMA flux, 63/37 solder (Sn/Pb) at 232°C for 5 seconds ±2 seconds.
Component Adhesion (Push Test)	4 pounds	Apply and measure force with a digital force gauge set.
Resistance to Solvent	No sign of degradation in appearance or marking detail.	Withstands 6 minutes of alcohol. Withstands 3 minutes forced spray Freon TMS
Load Life	After exposure, part shall not have a shorted or open winding.	Parts to be stored at 110°C for 1000 hours with rated current applied. Parts to be tested at: start, 500 and 1000 hours. Allow 2 hours at room temperature before testing.







For Print Distribution to Customers	Series	Revision
	DU SERIES	C
	Sheet 3 of 3	

Looking for pricing, stock, or lifecycle information?

Click below to explore more details on WIN SOURCE:

-  [View DU1352-4R7M on WIN SOURCE](#)
-  [TE Connectivity Information](#)

Optimize Your Supply Chain with WIN SOURCE Solutions

-  Global Sourcing Solution
-  Obsolete Management
-  Cost Control Management
-  Shortage Management
-  Alternative Solution
-  Excess Inventory Management