



**THE DATASHEET OF
ASTX-H11-20.000MHZ-T**



HCMOS OUTPUT SMD TCXO



3.2 x 2.5 x 1.0mm

ASTX-H11



ESD Sensitive



RoHS/RoHS II compliant

Moisture Sensitivity Level (MSL)-1

FEATURES:

- HCMOS Output
- Compact and low in height
- Low current consumption; IR reflow possible
- Suitable for high-density SMT

APPLICATIONS:

- Cellular and cordless phones
- Standard OSC for exact equipment
- Mobile communication equipment
- Portable radio equipment and music player

STANDARD SPECIFICATIONS:

Parameters	Minimum	Typical	Maximum	Units	Notes
Frequency Range	2.500		55.000	MHz	
Standard Frequencies	5, 10, 12, 16, 20, 24, 32, 40, 44			MHz	
Operating Temperature	-30		+75	°C	
Storage Temperature:	-40		+125	°C	
Frequency Stability $\Delta f/f_0$ vs Tolerance (@+25°C)	-2.0		+2.0	ppm	1 hr after reflow
vs Temperature (ref. to +25°C)	-2.5		+2.5		See option (Table 1)
vs Supply Voltage Change (Vdd±5%)	-0.2		+0.2		
vs Load Change (ZL±10%)	-0.2		+0.2		
vs Aging (first year @+25°C)	-1.0		+1.0		
Supply Voltage (Vdd)	+2.97	+3.3	+3.63	V	See option
Supply Current (Icc)			4.0	mA	4~10MHz
			4.8		~20MHz
			5.5		~30MHz
			6.0		~40MHz
			7.0		~54MHz
Rise and Fall Time (Tr/Tf)			5	ns	10%-90%Vdd
Symmetry	45		55	%	@1/2 Vdd
Output Voltage	V _{OH}	90%Vdd		V	
	V _{OL}		10%Vdd		
Load			15	pF	
Waveform	HCMOS				
Phase Noise (Frequency dependant)		-130		dBc	@1kHz offset
		-158			@100kHz offset
Tri-state Function (Stand-by) :	"1" (VIH≥0.7 5*Vdd) or Open: Oscillation "0" (VIL<0.25*Vdd) : Hi Z			V	



3.2 x 2.5 x 1.0mm

ASTX-H11



RoHS/RoHS II compliant

OPTIONS & PART IDENTIFICATION:

(Left blank if standard)

ASTX-H11- [] - [] MHz - [] - []

Vdd (V)
Blank: 3.3V±10%
A: 2.8V±10%
B: 2.5V±10%

Frequency in MHz
Please specify the frequency in MHz. e.g. 19.200MHz

Packaging
Blank: Bulk
T: 1000pcs/reel

	±2.5ppm	±3.0ppm	±4ppm	±5ppm
0°C ~ +50°C	D25	D30	D40	D50
-10°C ~ +60°C	E25	E30	E40	E50
-0°C ~ +70°C	F25	F30	F40	F50
-20°C ~ +75°C	G25	G30	G40	G50
-30°C ~ +75°C	Blank(STD)	H30	H40	H50
-40°C ~ +85°C	I25	I30	I40	I50

Table 1

OUTLINE DIMENSIONS:

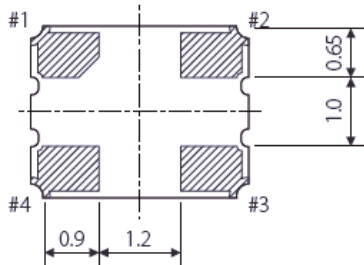
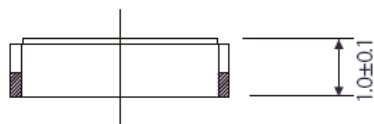
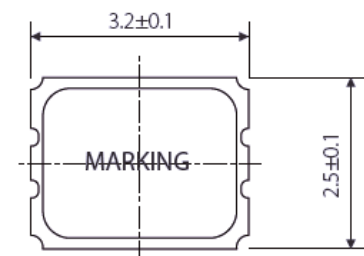

Recommended Land Pattern

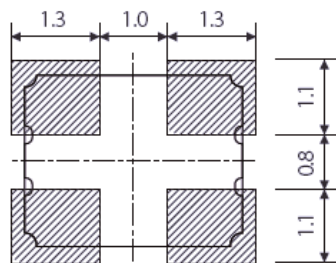

Tri-state pin	Output
High or floating	Active
Low	Hi-impedance

Note: Recommend using an approximately 0.01µF bypass capacitor between Pin 2 and 4.

PIN	FUNCTION
1	Tri-state
2	GND
3	Output
4	Vdd

Dimensions: mm



ASTX-H11

3.2 x 2.5 x 1.0mm

ASTX-H11



RoHS/RoHS II compliant

REFLOW PROFILE:

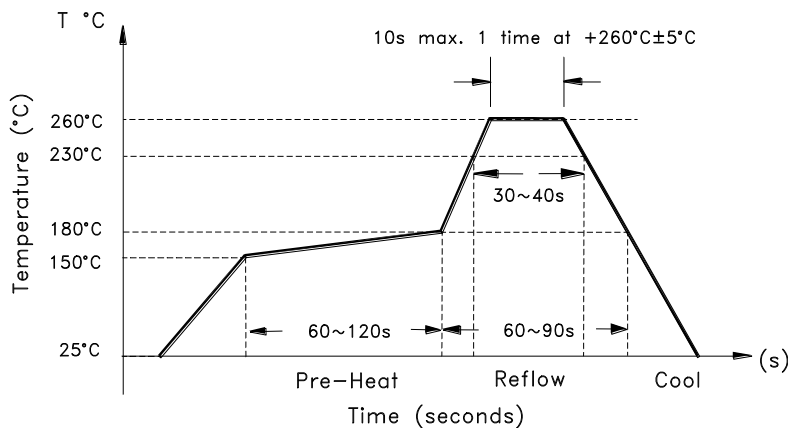

TAPE & REEL:

T: 1,000pcs/reel

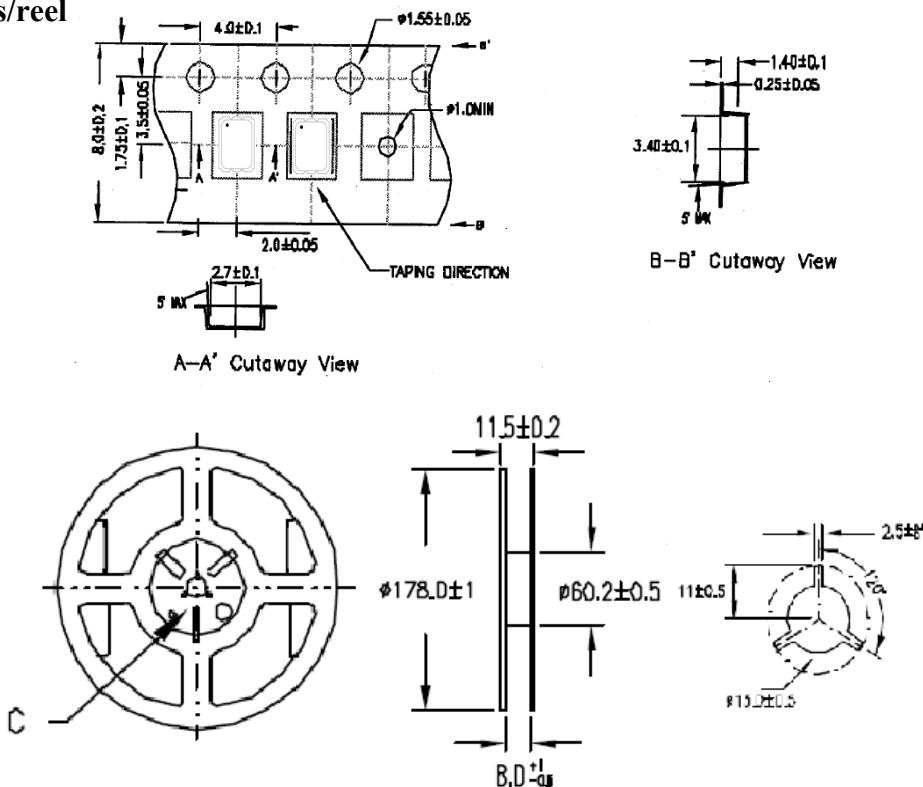

Dimensions: mm

ATTENTION: Abracon Corporation's products are COTS – Commercial-Off-The-Shelf products; suitable for Commercial, Industrial and, where designated, Automotive Applications. Abracon's products are not specifically designed for Military, Aviation, Aerospace, Life-dependant Medical applications or any application requiring high reliability where component failure could result in loss of life and/or property. For applications requiring high reliability and/or presenting an extreme operating environment, written consent and authorization from Abracon Corporation is required. Please contact Abracon Corporation for more information.



ABRACON IS
ISO 9001 : 2008
CERTIFIED



2 Faraday, Suite# B | Irvine | CA 92618 Revised: 05.13.15
Ph. 949.546.8000 | Fax. 949.546.8001
Visit www.abracon.com for Terms and Conditions of Sale

Looking for pricing, stock, or lifecycle information?

Click below to explore more details on WIN SOURCE:

-  [View ASTX-H11-20.000MHZ-T on WIN SOURCE](#)
-  [Abracon LLC Information](#)

Optimize Your Supply Chain with WIN SOURCE Solutions

-  Global Sourcing Solution
-  Obsolete Management
-  Cost Control Management
-  Shortage Management
-  Alternative Solution
-  Excess Inventory Management