



**THE DATASHEET OF
ECS-98.3-18-9**





Crystal Part Numbering Guide

Example: P/N ECS-160-20-5PX (Std P/N)
 P/N ECS-160-20-5PX-ADN (Custom P/N)

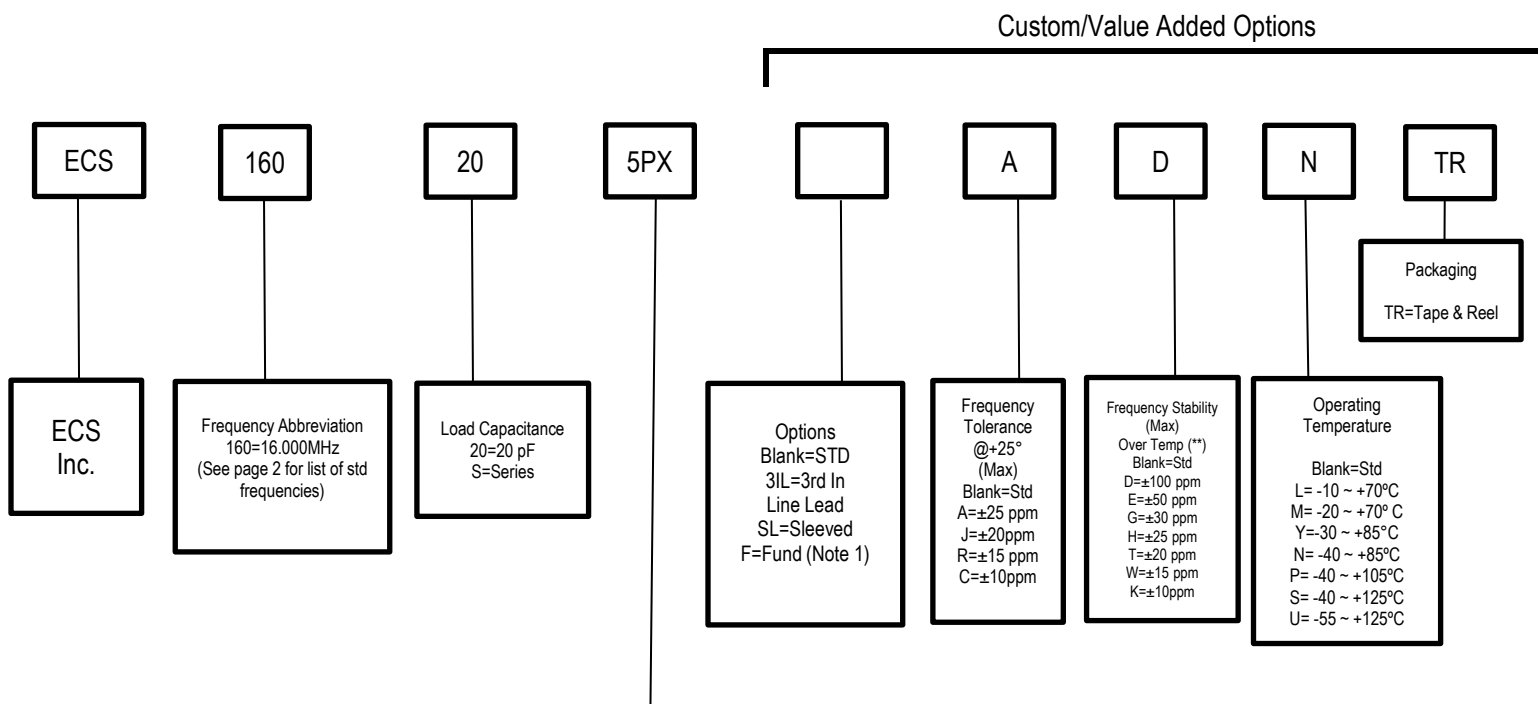

(Package Code) Model Types						
(1X) HC-49UX	(8X) ECS-3x8X	(17X) ECX-306X	(23G) ECS-23G	(33QZ) ECX-33BQZ	(36Q) ECX-2236Q	(49) ECX-49
(3X) CSM-3X	(9X) ECS-3x9X	(18) CSM-12	(24) ECX-3TA*	(33Q) ECX-33Q	(37) ECX-1637	
(4X) HC-49USX3.5H	(10X) ECS-3x10X	(19A) ECX-19A	(25) UM-4	(34B) ECX-31B	(37Q) ECX-1637Q	
(4LX) HC-49USX2.5H	(11) ECX-205*	(20A) CSM-8	(28AX) CSM-4A	(34G) ECX-34G	(38) ECX-71	
(4VX) HC-49USSX	(12) ECX-12	(20BM) CSM-8M	(28ALX) CSM-4ALX	(34R) ECX-34R	(39) ECX-39	
(5PX) CSM-7X4.3H	(12R) ECX-12R	(20BQ) CSM-8Q	(30) ECX-53	(34RR) ECX-34RR	(42) ECX-42	
(5PLX) CSM-7X3.2H	(12L) ECX-12L	(21) UM-5	(30B) ECX-53B	(34S) ECX-34S	(46X) HC-46X	
(5PVX) CSM-7SSX2.6H	(13X) ECS-2x6X	(22) UM-1	(30BQ) ECX-53BQ	(34Q) ECX-34Q	(47) ECX-1247	
(5G3X) CSM-7X-3L	(13FLX) ECS-2X6-FLX	(22SMJ) ECX-UM-1	(30BQZ) ECX-53BQZ	(35) CSM-9	(47Q) ECX-1247Q	
(6) ECX-206*	(14X) ECS-1x5X	(23A) ECX-64A	(33) ECX-32	(35BQZ) ECX-35BQZ	(48) ECX-1048	
(7SX) ECX-3SX	(16) ECX-16	(23B) ECX-64	(33B) ECS-33B	(36) ECX-2236	(48B) ECX-1048B	

* Discontinued

** Please consult ECS for available Temp Range options of tight stability crystals

Note 1: Crystals over 24,000 MHz will be 3rd overtone (if available on data sheet) unless fundamental mode is requested. An "F" suffix after the package type indicates a fundamental mode i.e. ECS-300-S-1-F would be a 30,000 MHz Fundamental mode crystal



Crystal Part Numbering Guide



Standard Frequency Abbreviations

Code	Frequency MHz
10	1.000
18	1.8432
20	2.000
20.48	2.048
24	2.4576
25	2.500
25.6	2.560
29	2.94912
30	3.000
30.72	3.072
32	3.2768
35	3.579545
36	3.6864
36.4	3.640
37	3.700
39	3.93216
40	4.000
40.3	4.032
41	4.096
42	4.194304
44	4.433618
45	4.500
49	4.9152
50	5.000
51	5.068
52	5.185
60	6.000
61	6.144
67.458	6.7458
73	7.3728
76.8	7.68
80	8.000
81.92	8.192
85	8.500
90	9.000
92.1	9.216

Code	Frequency MHz
95.4	9.545
96	9.600
98.3	9.8304
100	10.000
107.3	10.738635
110	11.000
110.4	11.046
110.5	11.0592
112.2	11.228
112.896	11.2896
115.2	11.520
119.8	11.98135
120	12.000
120.003	12.000393
121	12.096
122.8	12.288
125	12.500
128	12.800
129.6	12.960
130	13.000
132.250	13.225
132.256	13.225625
135	13.5168
135.212	13.52127
135.485	13.54856
135.6	13.560
140	14.000
143	14.31818
146	14.69
147.4	14.7456
150	15.000
153.6	15.360
160	16.000
160.003	16.000312
162.5	16.257
163.84	16.384

Code	Frequency MHz
166.666	16.66667
169.344	16.9344
177.3	17.734475
180	18.000
184	18.432
192	19.200
196.6	19.6608
200	20.000
214.7	21.47727
221	22.1184
225.792	22.5792
240	24.000
240.001	24.00014
245.7	24.576
250	25.000
260	26.000
270	27.000
271.2	27.120
282.24	28.224
286.3	28.63636
294.912	29.4912
300	30.000
320	32.000
327	32.768
330	33.000
333.33	33.333
338	33.8688
352.5	35.2512
360	36.000
380.005	38.00053
384	38.400
390	39.000
400	40.000
403.2	40.320
480	48.000
500	50.000
600	60.000
800	80.000







Looking for pricing, stock, or lifecycle information?

Click below to explore more details on WIN SOURCE:

 [View ECS-98.3-18-9 on WIN SOURCE](#)

 [ECS Inc. Information](#)

Optimize Your Supply Chain with WIN SOURCE Solutions

-  Global Sourcing Solution
-  Obsolete Management
-  Cost Control Management
-  Shortage Management
-  Alternative Solution
-  Excess Inventory Management