



THE DATASHEET OF
784771010



Q+products



Ferrite Beads
Axial EMI Suppression Ferrites
SMD Power Inductors

Q+products

Benefits

Q+products have given rise to plenty of discussions since their launch.

The most frequently asked questions: What advantage do these products give us?

To whom may I sell them? And for which applications are they suitable?

1

Optimized construction

Internal structures of the products in the Q+products portfolio are very different from conventional ones. For example, the wire connection between coil wire and component is not made with a conventional solder joint, but by means of a welding process. Another example is ferrite sleeves; compared with the conventional industry article, the surface form is optimized and this considerably simplifies the routing of lines.

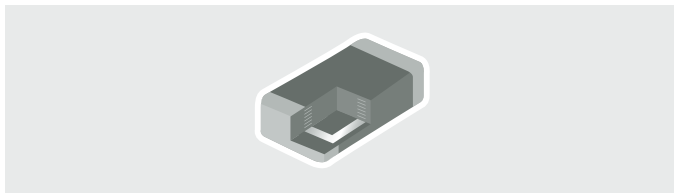

2

AEC-Q 200 qualification

All Q+products are qualified in accordance with the AEC-Q 200. The Automotive Electronics Council Qualification (AECQ) does not reflect the qualification standard of the automotive industry in all cases, but describes product quality very precisely only by means of a variety of reliability checks.



3

Higher level of automation

Automation vs. partial automation / manual process

Increasing the degree of automation in the manufacturing process changes the variance of process parameters positively by eliminating the influence of the operator. This also ensures even more effective process controlling.

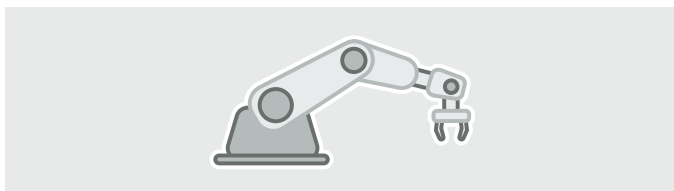

4

High process capability level

Process capability is determined by means of familiar statistics and describes the stability of a manufacturing process. A statistical evaluation by itself will not make a manufacturing process more stable, however. This also depends on the added values of other Q+products.



Q+products Benefits



5 Additional quality controls

Additional quality controls are geared specifically to the familiar, critical quality features of the individual Q+products. These features are directly monitored, documented and qualified according to their requirements in the appropriate manufacturing step.



6 Production on strictly defined production lines

Additional quality controls can be carried out efficiently only if they are used for previously evaluated production lines. Even two identical manufacturing processes can have different results. So process-based influences are difficult to generalize, which is why we specially select and monitor the production lines.

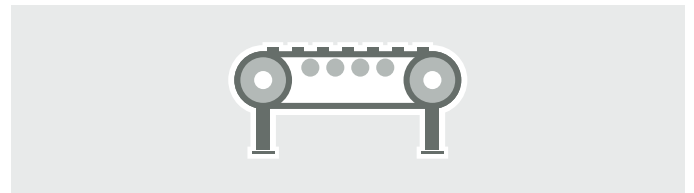

7 Extended temperature range

The market requires tough products. So we have already extended the temperature range of Q+products ferrite sleeves to -55°C / $+150^{\circ}\text{C}$. We also aim to extend such increases in temperature range to include all Q+products.

Temperature range up to $+150^{\circ}\text{C}$



Q+products

Qualification Standard

The qualification standard refers to the AEC-Q 200 and is performed for all products which are shown in this catalogue. For your reference, you can find in the following table a short summary of the performed tests for inductors/transformers.

High Temperature Exposure

Storage for 1000 hours to at rated operating temperature (according to the datasheet)

Temperature Cycling

1000 cycles at operating temperature (according to the datasheet, e.g. -40 °C / +125 °C). with an maximum dwell time of one minute.

Biased Humidity

1000 hours at 85 °C and 85 % RH without electrical stress

Operational Life

1000 hours at operating temperature minus self-heating temperature under electrical stress (rated current)

External Visual

Inspection of the device looking/construction, workmanship and marking.

Physical Dimension

The mechanical dimension have to be in between the specification

Terminal Strength (SMD)

The parts will be stressed with a pull of force of 17.7 Newton for 60 seconds. The focus is on the soldering joint.

Resistance to Solvents

Three different kinds of solvent do not have any impact to the device construction, marking and looking.

Mechanical Shock

Mechanical shocks shall not have any impact to the device construction or function. These shocks will be simulated 18 times, by a amplitude of 100 g's for 6 milliseconds.

Vibration

Vibrations of 10 g's in a frequency range from 15 up to 2000 Hz for 20 minutes shall not have any impact to the construction of the device. This process will be done in 12 cycles for each of the Axis.

Resistance to Soldering Heat

A Reflow Oven Test for five times shall not have any impact to the device

ESD

An Electrostatic discharge of 6 kV with direct contact, 12 kV, 16 kV and 25 kV with air contact shall not have any impact to the device.

Solderability

Three different Soldering procedures will be gone through. In each case an impact to the device and construction isn't allowed.

Electrical Characterization

Parametrically test which shows in a summary the min, max, man and standard deviation at room temperature as well as at min and max operating temperature.

Board Flex

At surface mounted devices, an impact due to bending, flexing and pulling forces shall be not be given.



Q+products Standards by Comparison



Although it might seem much better at the first sight, it doesn't mean, that the industrial parts are less qualified than the Q+ Products. The difference in here is the higher reliable requirements which we going to prove accordance to the AEC-Q 200. To show the difference, the following table contrasts some main parts out of the industrial qualification standard of Würth Elektronik eiSos with the main necessary qualification standards out of the AEC-Q 200.

| Test description | Industrial Standard | Q+products Standard |
|------------------------------|---------------------|----------------------|
| High Temperature Exposure | 500 hours | 1000 hours |
| Temperature Cycling | 500 cycles | 1000 cycles |
| Biased Humidity | - | 1000 hours |
| Moisture Resistance | 500 hours | - |
| Operational Life | 1000 hours | 1000 hours |
| External Visual | ✓ | ✓ |
| Physical Dimension | - | ✓ |
| Terminal strength | ✓ | ✓ |
| Resistance to solvent | - | 3 different Solvents |
| Mechanical Shock | - | ✓ |
| Vibration | ✓ | ✓ |
| Resistance to Soldering Heat | 5 time Reflow | 5 time Reflow |
| ESD | - | ✓ |
| Solderability | ✓ | ✓ |
| Electrical Characterization | - | ✓ |
| Board Flex | ✓ | ✓ |
| Low Temperature Exposure | ✓ | - |

Legend to the table:

- ✓ both of the tests are the same
- not tested



Waldenburg (Germany)



Shenyang (China)

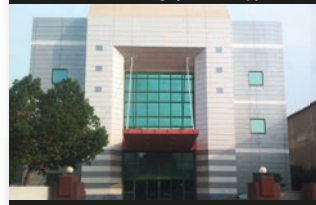

Taichung (Taiwan)



Longgang (China)

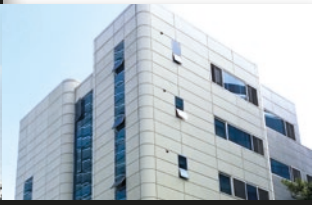

Seoul (Korea)

Production Site
Quality & Design Center

WE-CBA

SMD EMI Suppression Ferrite Bead

Size 0402



Characteristics

- Reliable Ni-Sn electrodes
- High rated current up to 5A
- Recommended soldering: Reflow
- Operating temperature: -55 °C to +125 °C

Applications

- Perfect as data lined filter and for uncoupling of distribution voltage

Type definition of SMD ferrites WE-CBA

The special SMD chip bead ferrites can be put directly on the printed circuit board. They offer excellent anti-EMI properties and low DC-resistance. Placed very close next to the interference source even with smallest size 0402, maximal impedance at 1000 Ω can be reached.

High Speed:

"High Speed" SMD ferrites WE-CBA have lower impedance in the lower frequency ranges thus they have only a low attenuation for fast signals.

Application e.g. USB 2.0, IEEE 1394, LVDS

Wide Band:

"Wide Band" SMD ferrites WE-CBA already show high impedance in low frequency range. Therefore they are wide band through the whole spectrum.

Application e.g. control signals, RS232, RS422, DC/DC converter

High Current:

"High Current" SMD ferrites WE-CBA are designed for high current (over 1 A). The rated current refers to 40 K self-heating.

High current SMD ferrites are available in all three types (High Speed, Wide Band and High Frequency).

Application e.g. power supply, DC/DC converter

Advice: Pay attention for the use of SMD ferrites for high rated current >1 A and ambient temperature over +85 °C that the rated current has to be reduced when temperature is above +85 °C (Derating).

The characteristic line in the right figure shows, that e.g. at +100 °C ambient temperature the maximal rated current has to add up to only 60 % of the data sheet value, without an overload of the component.

Derating +85 °C



Derating +105 °C

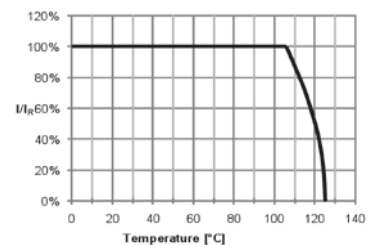

Electrical properties

| Order Code | Z @ 100 MHz (Ω) | Z _{max} (Ω) | Testcondition Z _{max} (MHz) | I _R (mA) | R _{DC} (Ω) | Type of Application |
|-------------|-----------------|----------------------|--------------------------------------|---------------------|---------------------|---------------------|
| 782 422 101 | 100 | 180 | 500 | 500 | 0.30 | Wide Band |
| 782 422 221 | 220 | 330 | 400 | 400 | 0.30 | Wide Band |
| 782 422 331 | 330 | 640 | 300 | 300 | 0.50 | Wide Band |
| 782 422 511 | 510 | 730 | 300 | 200 | 0.80 | Wide Band |
| 782 422 601 | 600 | 800 | 300 | 200 | 0.80 | Wide Band |
| 782 422 102 | 1000 | 1200 | 170 | 200 | 1.00 | Wide Band |
| 782 423 100 | 10 | 17 | 700 | 1500 | 0.03 | High Current |
| 782 423 700 | 70 | 140 | 600 | 1000 | 0.09 | High Current |

Land pattern (in mm)

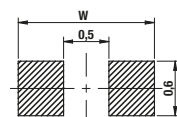

WIDE BAND: W = 1,5
HIGH CURRENT: W = 2,2

Dimensions (in mm)



WE-CBA

SMD EMI Suppression Ferrite Bead

Size 0402



Typical impedance characteristics Wide Band

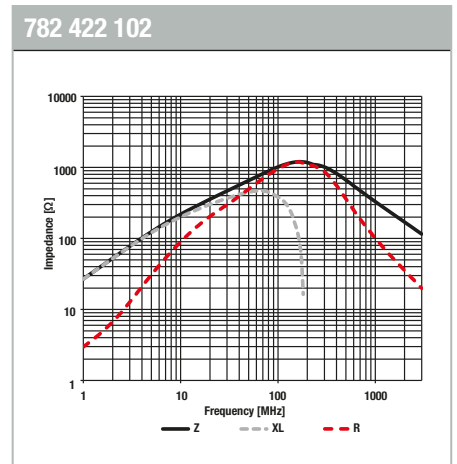
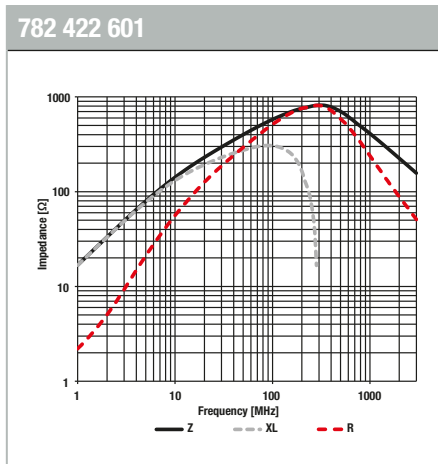
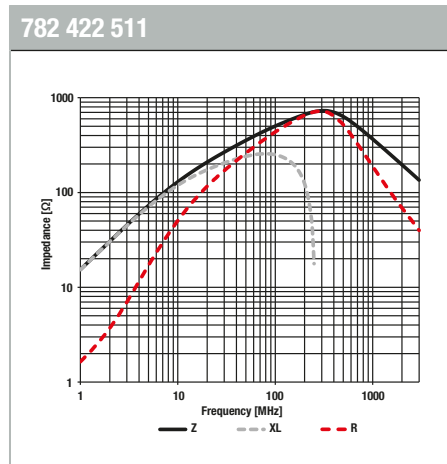
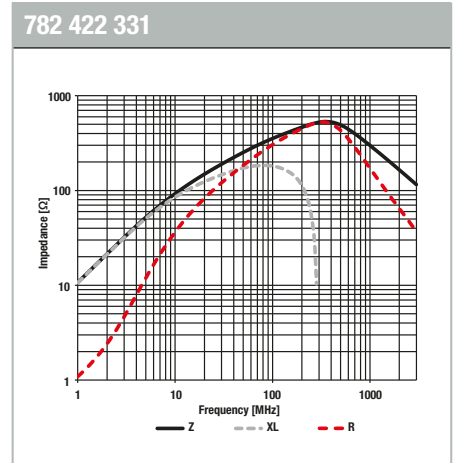
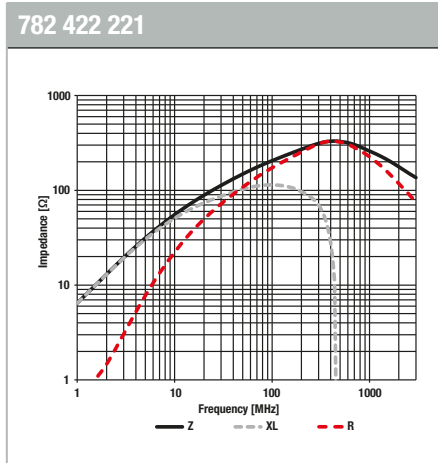
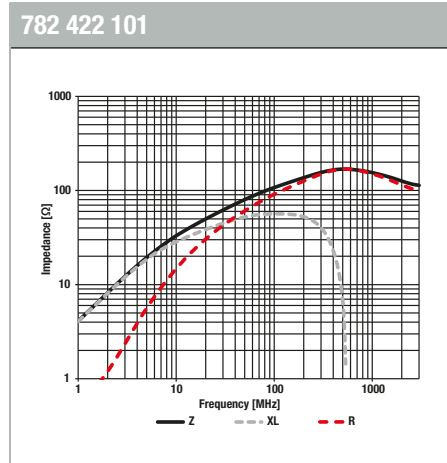

High Current

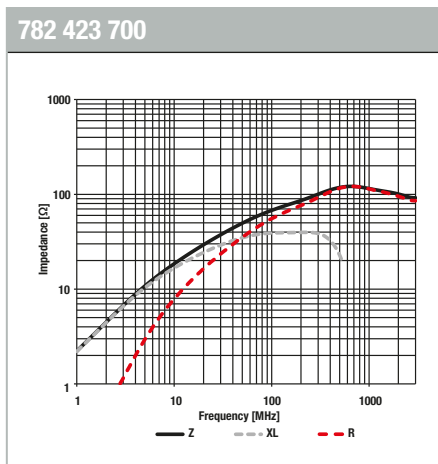
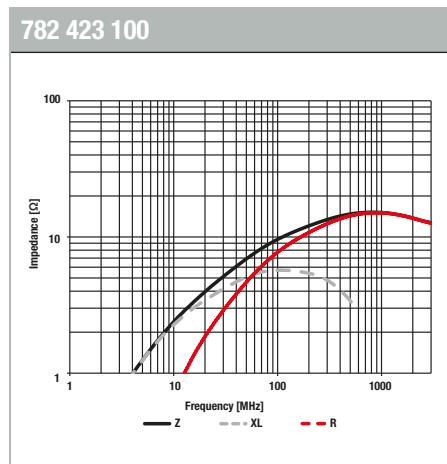

WE-CBA

SMD EMI Suppression Ferrite Bead

Size 0603

Electrical properties

| Order Code | Z @ 100 MHz (Ω) | Z _{max} (Ω) | Testcondition Z _{max} (MHz) | I _R (mA) | R _{DC} (Ω) | Type of Application |
|-------------|-----------------|----------------------|--------------------------------------|---------------------|---------------------|---------------------|
| 782 631 101 | 100 | 610 | 400 | 500 | 0.20 | High Speed |
| 782 631 331 | 330 | 690 | 280 | 400 | 0.25 | High Speed |
| 782 631 182 | 1800 | 2300 | 130 | 100 | 0.75 | High Speed |
| 782 632 620 | 62 | 95 | 500 | 500 | 0.15 | Wide Band |
| 782 632 121 | 120 | 190 | 450 | 500 | 0.20 | Wide Band |
| 782 632 181 | 180 | 280 | 380 | 500 | 0.20 | Wide Band |
| 782 632 511 | 510 | 610 | 200 | 300 | 0.35 | Wide Band |
| 782 632 102 | 1000 | 1100 | 150 | 200 | 0.50 | Wide Band |
| 782 633 620 | 62 | 98 | 600 | 2500 | 0.04 | High Current |
| 782 633 601 | 600 | 660 | 190 | 1000 | 0.20 | High Current |

Dimensions (in mm)



Land pattern (in mm)



WIDE BAND / HIGH SPEED: W = 2,2
HIGH CURRENT: W = 2,6

Typical impedance characteristics High Speed

782 631 101



782 631 331



782 631 182



WE-CBA

SMD EMI Suppression Ferrite Bead

Size 0603



Typical impedance characteristics Wide Band

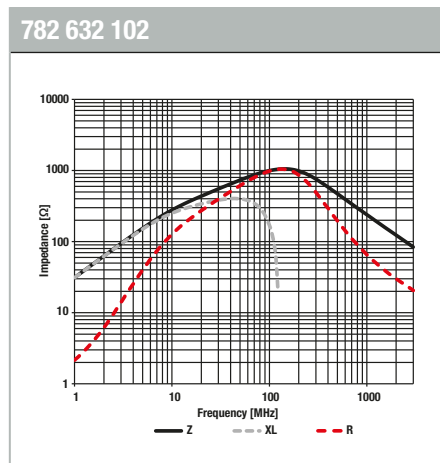
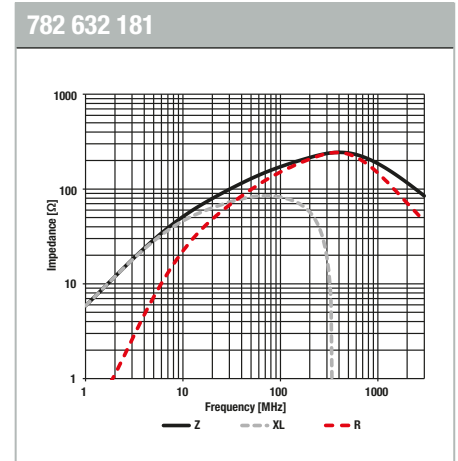
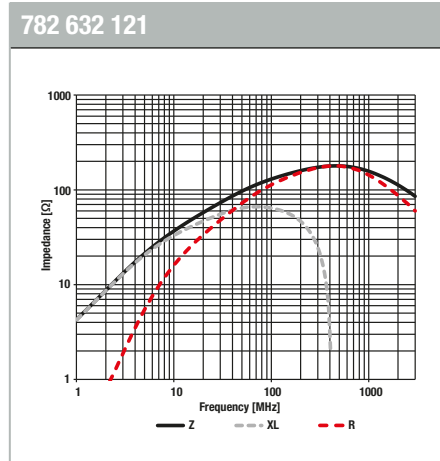

High Current

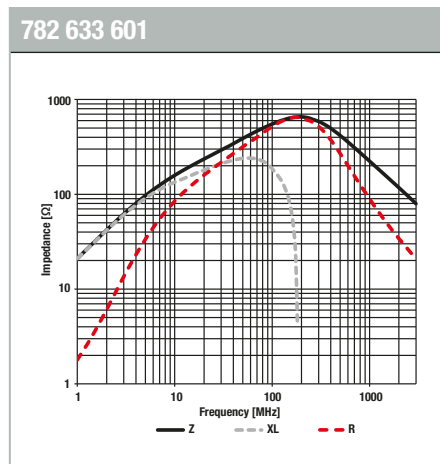
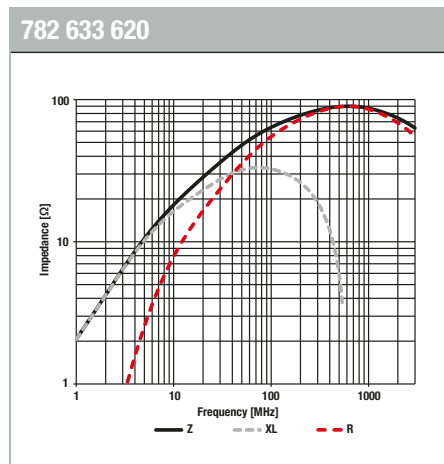

WE-CBA

SMD EMI Suppression Ferrite Bead

Size 0805

Electrical properties

| Order Code | Z @ 100 MHz (Ω) | Z _{max} (Ω) | Testcondition Z _{max} (MHz) | I _R (mA) | R _{DC} (Ω) | Type of Application |
|-------------|-----------------|----------------------|--------------------------------------|---------------------|---------------------|---------------------|
| 782 851 102 | 1000 | 1100 | 150 | 300 | 0.350 | High Speed |
| 782 851 202 | 2200 | 2200 | 100 | 200 | 0.450 | High Speed |
| 782 853 200 | 20 | 35 | 700 | 5000 | 0.008 | High Current |
| 782 853 270 | 27 | 45 | 700 | 4000 | 0.015 | High Current |
| 782 853 680 | 68 | 110 | 500 | 3000 | 0.025 | High Current |
| 782 853 910 | 91 | 105 | 400 | 2000 | 0.060 | High Current |
| 782 853 121 | 120 | 180 | 300 | 2500 | 0.035 | High Current |
| 782 853 221 | 220 | 290 | 200 | 2000 | 0.050 | High Current |
| 782 853 561 | 560 | 600 | 160 | 1500 | 0.100 | High Current |
| 782 853 112 | 1100 | 1400 | 70 | 800 | 0.300 | High Current |
| 782 853 152 | 1500 | 1800 | 70 | 700 | 0.350 | High Current |

Dimensions (in mm)

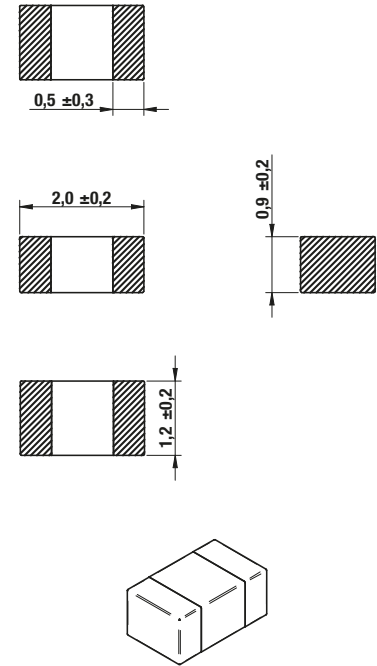

Land pattern (in mm)

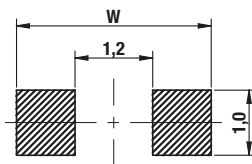

HIGH SPEED: W = 3,0
 HIGH CURRENT: W = 4,0

Typical impedance characteristics High Speed

782 851 102



782 851 202



WE-CBA

SMD EMI Suppression Ferrite Bead

Size 0805



Typical impedance characteristics High Current



WE-CBA

SMD EMI Suppression Ferrite Bead

Size 1206

Electrical properties

| Order Code | Z @ 100 MHz (Ω) | Z _{max} (Ω) | Testcondition Z _{max} (MHz) | I _R (mA) | R _{DC} (Ω) | Type of Application |
|-------------|-----------------|----------------------|--------------------------------------|---------------------|---------------------|---------------------|
| 782 762 301 | 300 | 360 | 160 | 500 | 0.100 | Wide Band |
| 782 763 820 | 82 | 130 | 500 | 3000 | 0.025 | High Current |
| 782 763 621 | 620 | 620 | 100 | 1500 | 0.100 | High Current |
| 782 763 102 | 1000 | 1200 | 80 | 1000 | 0.300 | High Current |

Land pattern (in mm)



WIDE BAND: W = 4,2
HIGH CURRENT: W = 5,2

Dimensions (in mm)



Typical impedance characteristics Wide Band

782 762 301

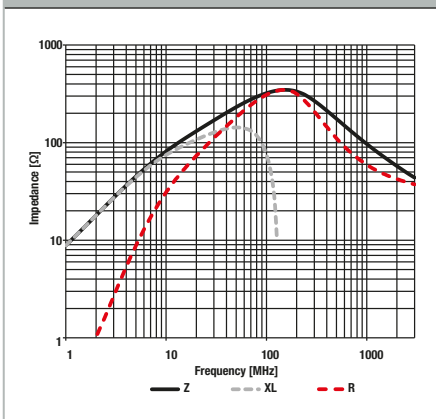

High Current

782 763 820

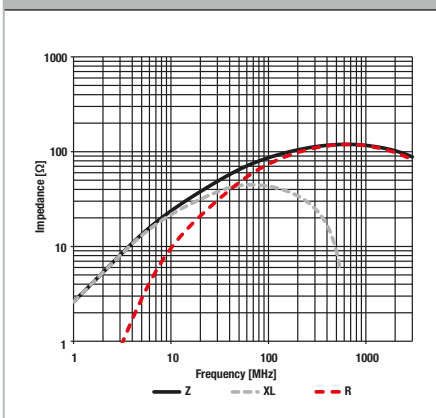

782 763 621

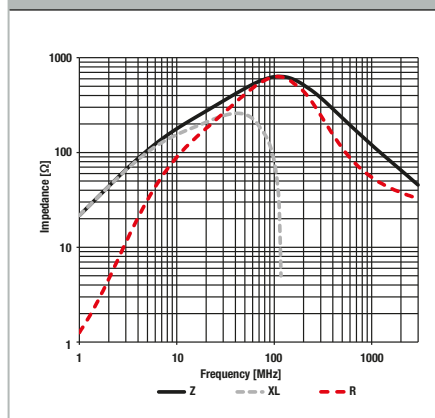

782 763 102

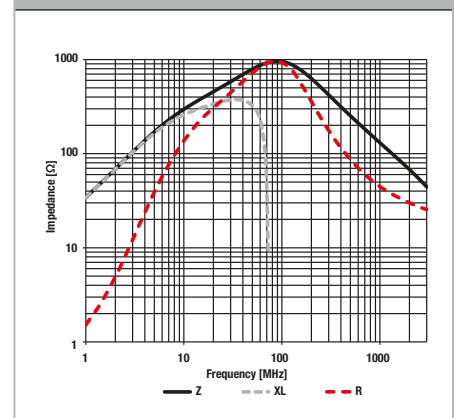

WE-CBA

SMD EMI Suppression Ferrite Bead

Size 1806



| Electrical properties | | | | | | |
|-----------------------|-----------------|----------------------|--------------------------------------|---------------------|---------------------|---------------------|
| Order Code | Z @ 100 MHz (Ω) | Z _{max} (Ω) | Testcondition Z _{max} (MHz) | I _R (mA) | R _{DC} (Ω) | Type of Application |
| 782 963 560 | 56 | 90 | 1000 | 5000 | 0.008 | High Current |
| 782 963 820 | 82 | 110 | 1000 | 3500 | 0.020 | High Current |



Typical impedance characteristics High Current



WE-AEFA

Axial EMI Suppression Ferrite



Temperature range
up to +150 °C



Characteristics

- Ferrite core made of NiZn, a material which works in a wide frequency range
- Many different types for the best possible interference suppression
- Operating temperature: -55 °C up to +150 °C

Applications

- In general for: wires, coaxial cables, wire-wrapping cables, multiconductor wires
- Data and signal lines
- On board power supply line
- Multimedia cable interfaces
- Various, other cable interfaces

Electrical properties

| Order Code | OD (mm) | ID (mm) | H (mm) | Cable Diameter (mm) | Z @ 25 MHz 1 turn (Ω) | Z @ 100 MHz 1 turn (Ω) |
|-----------------|---------|---------|--------|---------------------|-----------------------|------------------------|
| 782 013 033 150 | 12.0 | 3.55 | 15.0 | ≤ 3.3 | 150 | 205 |
| 782 013 044 095 | 9.5 | 4.75 | 9.5 | ≤ 4.4 | 60 | 84 |
| 782 013 046 185 | 11.5 | 5.0 | 18.5 | ≤ 4.6 | 135 | 186 |
| 782 013 046 250 | 11.5 | 5.0 | 25.0 | ≤ 4.6 | 185 | 255 |
| 782 013 057 450 | 12.0 | 6.1 | 45.0 | ≤ 5.7 | 255 | 370 |
| 782 013 059 285 | 14.0 | 6.3 | 28.5 | ≤ 5.9 | 195 | 270 |
| 782 013 068 250 | 14.0 | 7.2 | 25.0 | ≤ 6.8 | 150 | 210 |
| 782 013 069 155 | 12.0 | 7.3 | 15.5 | ≤ 6.9 | 70 | 100 |
| 782 013 069 285 | 15.5 | 7.3 | 28.5 | ≤ 6.9 | 190 | 270 |
| 782 013 076 285 | 16.0 | 8.0 | 28.5 | ≤ 7.6 | 170 | 240 |
| 782 013 076 508 | 16.0 | 8.0 | 50.8 | ≤ 7.6 | 325 | 460 |
| 782 013 079 285 | 14.0 | 8.2 | 28.5 | ≤ 7.9 | 140 | 200 |
| 782 013 086 280 | 16.0 | 9.0 | 28.0 | ≤ 8.6 | 140 | 205 |
| 782 013 091 285 | 17.5 | 9.5 | 28.5 | ≤ 9.1 | 150 | 220 |
| 782 013 100 280 | 15.5 | 10.5 | 28.0 | ≤ 10.0 | 100 | 150 |
| 782 013 110 508 | 19.0 | 11.5 | 50.8 | ≤ 11.0 | 235 | 345 |
| 782 013 125 280 | 19.0 | 13.0 | 28.0 | ≤ 12.5 | 95 | 150 |
| 782 013 125 285 | 26.0 | 13.0 | 28.5 | ≤ 12.5 | 170 | 240 |
| 782 013 150 285 | 26.0 | 15.5 | 28.5 | ≤ 15.0 | 130 | 190 |

Dimensions (in mm)



WE-AEFA

Axial EMI Suppression Ferrite



Typical impedance characteristics



Typical impedance characteristics



WE-PDA SMD Shielded Power Inductor

Size 7332



Characteristics

- Wire connection: welding technology
- Operating Temperature -40°C up to +125°C
- Highest possible current loading for SMD Inductors
- Magnetically shielded version which results in a low leakage field
- High storage capacity
- Low self-losses
- Core Material: NiZn

Applications

- Multimedia applications
- Switching regulators with low operating voltages (Computer, Notebook, smart phones)
- Integrated DC/DC-converter
- Perfect suitable for switching regulators with extremely high efficiency (> 86%)

Electrical properties

| Order Code | L (µH) | Tolerance (%) | R _{DC} (mΩ) max. | I _R (A) | I _{Sat} (A) |
|-------------|--------|---------------|---------------------------|--------------------|----------------------|
| 784 778 010 | 1.0 | 20% | 36 | 5.37 | 6.40 |
| 784 778 022 | 2.2 | 20% | 50 | 4.00 | 4.80 |
| 784 778 033 | 3.3 | 20% | 65 | 3.42 | 4.20 |
| 784 778 047 | 4.7 | 20% | 79 | 2.90 | 3.90 |
| 784 778 068 | 6.8 | 20% | 95 | 2.50 | 2.75 |
| 784 778 082 | 8.2 | 20% | 103 | 2.2 | 2.4 |
| 784 778 100 | 10 | 20% | 126 | 1.83 | 2.20 |
| 784 778 220 | 22 | 20% | 190 | 1.40 | 1.40 |
| 784 778 470 | 47 | 20% | 350 | 1.10 | 1.00 |
| 784 778 101 | 100 | 20% | 720 | 0.75 | 0.67 |
| 784 778 221 | 220 | 20% | 1620 | 0.54 | 0.42 |
| 784 778 471 | 470 | 20% | 3300 | 0.32 | 0.31 |
| 784 778 102 | 1000 | 20% | 7200 | 0.20 | 0.18 |

Dimensions (in mm)



Land pattern (in mm)



Inductance vs. Current

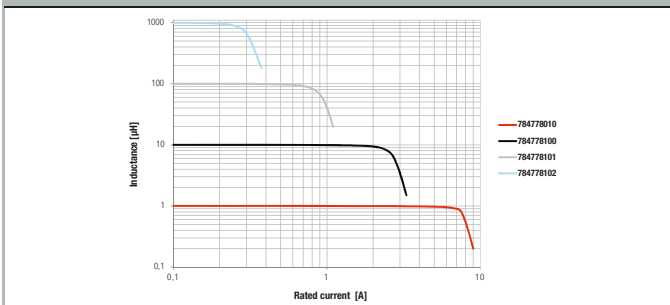

WE-PDA

SMD Shielded Power Inductor

Size 7345

Electrical properties

| Order Code | L (µH) | Tolerance (%) | R _{DC} (mΩ) max. | I _R (A) | I _{Sat} (A) |
|-------------|--------|---------------|---------------------------|--------------------|----------------------|
| 784 777 010 | 1.0 | 20% | 38 | 3.7 | 8 |
| 784 777 022 | 2.2 | 20% | 60 | 2.7 | 5.25 |
| 784 777 033 | 3.3 | 20% | 69 | 2.5 | 4.7 |
| 784 777 047 | 4.7 | 20% | 84 | 2.35 | 3.7 |
| 784 777 068 | 6.8 | 20% | 99 | 2.2 | 3.2 |
| 784 777 082 | 8.2 | 20% | 115 | 2 | 2.8 |
| 784 777 100 | 10 | 20% | 126 | 1.9 | 2.6 |
| 784 777 220 | 22 | 20% | 215 | 1.4 | 1.8 |
| 784 777 470 | 47 | 20% | 300 | 1.15 | 1.25 |
| 784 777 101 | 100 | 20% | 470 | 0.72 | 0.80 |
| 784 777 221 | 220 | 20% | 1135 | 0.56 | 0.53 |
| 784 777 471 | 470 | 20% | 2720 | 0.35 | 0.38 |
| 784 777 102 | 1000 | 20% | 5760 | 0.25 | 0.28 |

Dimensions (in mm)

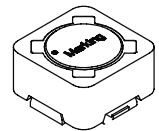
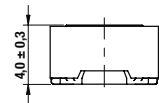

Land pattern (in mm)



Inductance vs. Current



WE-PDA SMD Shielded Power Inductor

Size 1260



| Electrical properties | | | | | |
|-----------------------|--------|---------------|---------------------------|--------------------|----------------------|
| Order Code | L (µH) | Tolerance (%) | R _{DC} (mΩ) max. | I _R (A) | I _{Sat} (A) |
| 784 771 010 | 1.0 | 20% | 8.50 | 9.00 | 16.50 |
| 784 771 022 | 2.2 | 20% | 12.50 | 7.20 | 10.50 |
| 784 771 033 | 3.3 | 20% | 14.70 | 6.50 | 9.00 |
| 784 771 047 | 4.7 | 20% | 17.50 | 6.20 | 8.00 |
| 784 771 068 | 6.8 | 20% | 21.50 | 5.50 | 6.00 |
| 784 771 082 | 8.2 | 20% | 24.00 | 5.05 | 5.50 |
| 784 771 100 | 10 | 20% | 26.50 | 5.00 | 5.25 |
| 784 771 220 | 22 | 20% | 41.00 | 3.20 | 3.50 |
| 784 771 470 | 47 | 20% | 77.00 | 2.30 | 2.50 |
| 784 771 101 | 100 | 20% | 174 | 1.50 | 1.70 |
| 784 771 221 | 220 | 20% | 348 | 0.99 | 1.10 |
| 784 771 471 | 470 | 20% | 706 | 0.65 | 0.75 |
| 784 771 102 | 1000 | 20% | 1704 | 0.48 | 0.53 |

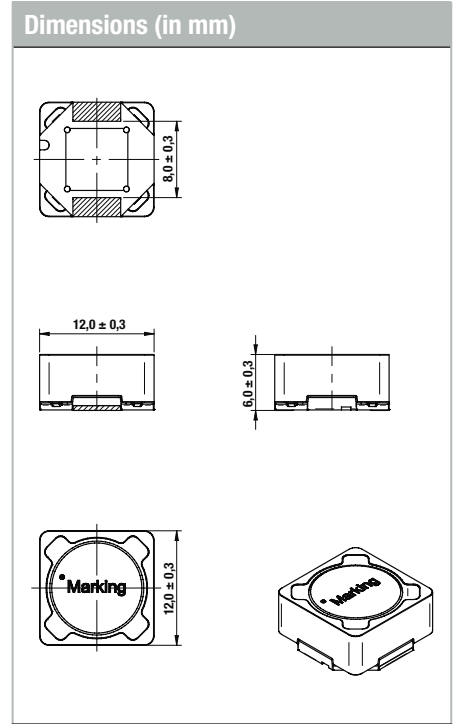

WE-PDA

SMD Shielded Power Inductor

Size 1280

Electrical properties

| Order Code | L (µH) | Tolerance (%) | R _{DC} (mΩ) max. | I _R (A) | I _{Sat} (A) |
|-------------|--------|---------------|---------------------------|--------------------|----------------------|
| 784 770 10 | 1.0 | 20% | 9.8 | 8.3 | 22.0 |
| 784 770 22 | 2.2 | 20% | 14.5 | 7.0 | 15.0 |
| 784 770 33 | 3.3 | 20% | 21.4 | 6.6 | 12.0 |
| 784 770 47 | 4.7 | 20% | 19.8 | 6.0 | 11.0 |
| 784 770 68 | 6.8 | 20% | 25 | 5.2 | 8.5 |
| 784 770 100 | 10 | 20% | 31 | 5.0 | 6.8 |
| 784 770 220 | 22 | 20% | 45 | 4.0 | 4.7 |
| 784 770 470 | 47 | 20% | 70 | 3.1 | 3.4 |
| 784 770 101 | 100 | 20% | 145 | 2.1 | 2.3 |
| 784 770 221 | 220 | 20% | 300 | 1.2 | 1.4 |
| 784 770 471 | 470 | 20% | 570 | 0.8 | 1.0 |
| 784 770 102 | 1000 | 20% | 1199 | 0.72 | 0.8 |

Dimensions (in mm)

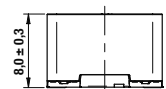

Land pattern (in mm)



Inductance vs. Current



WE-PDA SMD Shielded Power Inductor

Size 1210



| Electrical properties | | | | | |
|-----------------------|--------|---------------|---------------------------|--------------------|----------------------|
| Order Code | L (µH) | Tolerance (%) | R _{DC} (mΩ) max. | I _R (A) | I _{Sat} (A) |
| 784 770 9010 | 1.0 | 20% | 9.60 | 9.2 | 23 |
| 784 770 9022 | 2.2 | 20% | 14.5 | 7.5 | 16 |
| 784 770 9033 | 3.3 | 20% | 17.00 | 7.0 | 13.5 |
| 784 770 9047 | 4.7 | 20% | 19.50 | 6.0 | 11.0 |
| 784 770 9068 | 6.8 | 20% | 24.50 | 5.5 | 9.0 |
| 784 770 9100 | 10 | 20% | 29.50 | 5.0 | 7.5 |
| 784 770 9220 | 22 | 20% | 45.00 | 4.3 | 5.0 |
| 784 770 9470 | 47 | 20% | 67.00 | 3.2 | 3.5 |
| 784 770 9101 | 100 | 20% | 123.00 | 2.2 | 2.4 |
| 784 770 9221 | 220 | 20% | 247.00 | 1.45 | 1.6 |
| 784 770 9471 | 470 | 20% | 495.00 | 0.9 | 1.1 |
| 784 770 9102 | 1000 | 20% | 1060.00 | 0.63 | 0.7 |

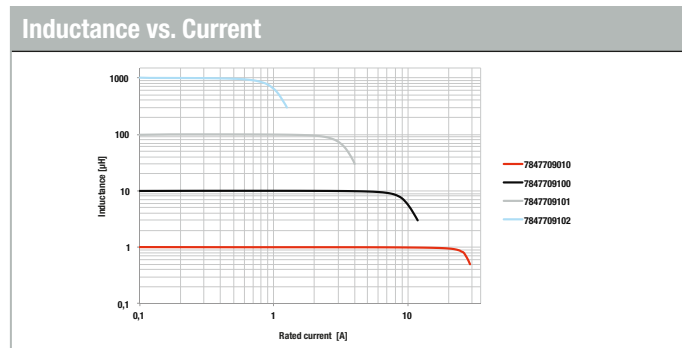
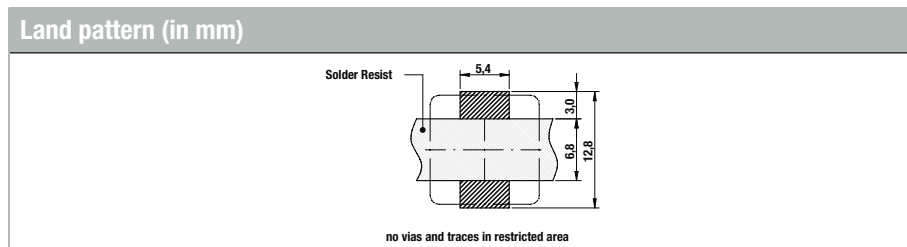
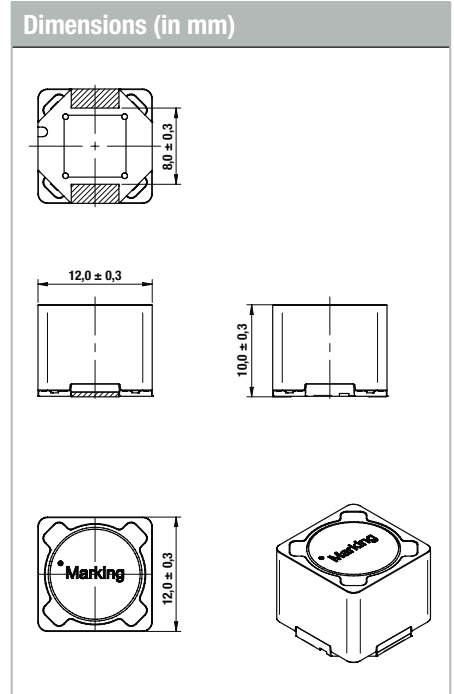

WE-PD2A

SMD Power Inductor

Size 4532



Characteristics

- Open size
- Current capability up to 14 A
- Operating temperature: -40 °C to +125 °C
- Recommended solder profile: Reflow

Applications

- Switching regulators with low operating voltage (navigation system, air conditioning, entertainment, park assistance control)
- Integrated DC/DC-converter
- Perfectly suitable for switching regulators with extremely high efficiency

Note

The ambient temperature when operating the WE-PD series of storage chokes at full current rating load should generally range from -40 °C to +85 °C. The self-heating of the component must be taken into account at higher ambient temperatures in order that the permissible solder joint temperature is not exceeded or the wire insulation damaged. The wire used can withstand a temperature of up to +150 °C. The ferrite core itself may be used over a far greater temperature range (approx. -50 °C to +250 °C [Curie temperature]). However, in this case, the tolerance limits of the inductor may be exceeded due to the temperature dependence of permeability.

Current derating at ambient temperature of > 85 °C

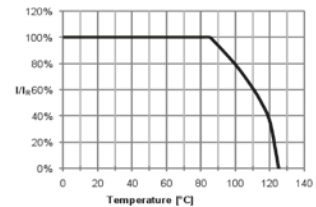

Inductance vs. DC bias current

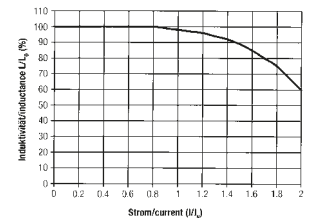

Electrical properties: Size 4532

| Order Code | L (µH) | Tolerance (%) | R _{DC} typ. (Ω) | R _{DC} max. (Ω) | I _R (A) | I _{sat} (A) |
|-------------|--------|---------------|--------------------------|--------------------------|--------------------|----------------------|
| 784 773 0 | 1.0 | ±20 | 0.014 | 0.049 | 4.00 | 5.72 |
| 784 773 018 | 1.8 | | 0.028 | 0.064 | 2.70 | 3.60 |
| 784 773 022 | 2.2 | | 0.034 | 0.071 | 2.50 | 3.38 |
| 784 773 033 | 3.3 | | 0.041 | 0.086 | 2.00 | 2.88 |
| 784 773 039 | 3.9 | | 0.054 | 0.094 | 1.88 | 2.57 |
| 784 773 047 | 4.7 | | 0.059 | 0.110 | 1.82 | 2.46 |
| 784 773 056 | 5.6 | | 0.069 | 0.126 | 1.58 | 2.43 |
| 784 773 068 | 6.8 | | 0.076 | 0.131 | 1.54 | 2.10 |
| 784 773 082 | 8.2 | | 0.116 | 0.146 | 1.50 | 1.80 |
| 784 773 10 | 10 | | 0.118 | 0.182 | 1.45 | 1.74 |
| 784 773 112 | 12 | | 0.156 | 0.210 | 1.28 | 1.62 |
| 784 773 115 | 15 | | 0.204 | 0.235 | 1.20 | 1.46 |
| 784 773 118 | 18 | 0.225 | 0.338 | 1.10 | 1.29 | |
| 784 773 122 | 22 | 0.261 | 0.370 | 1.00 | 1.22 | |
| 784 773 127 | 27 | ±10 | 0.328 | 0.522 | 0.94 | 1.00 |
| 784 773 133 | 33 | | 0.370 | 0.540 | 0.86 | 0.90 |
| 784 773 139 | 39 | | 0.418 | 0.587 | 0.77 | 0.87 |
| 784 773 147 | 47 | | 0.523 | 0.844 | 0.68 | 0.77 |
| 784 773 156 | 56 | | 0.714 | 0.937 | 0.64 | 0.75 |
| 784 773 168 | 68 | | 0.754 | 1.117 | 0.56 | 0.68 |

Dimensions (in mm): Size 4532



WE-PD2A SMD Power Inductor

Size 4532 / Size 5848



Inductance vs. rated current: Size 4532



Land pattern (in mm): Size 4532



Electrical properties: Size 5848

| Order Code | L (µH) | Tolerance (%) | R _{DC} typ. (Ω) | R _{DC} max. (Ω) | I _R (A) | I _{sat} (A) |
|-------------|--------|---------------|--------------------------|--------------------------|--------------------|----------------------|
| 784 774 003 | 0.33 | ±20 | 0.006 | 0.008 | 10.8 | 15.30 |
| 784 774 006 | 0.6 | -40/+20 | 0.009 | 0.018 | 8.20 | 13.50 |
| 784 774 022 | 2.2 | ±20 | 0.026 | 0.041 | 4.60 | 8.20 |
| 784 774 027 | 2.7 | | 0.032 | 0.045 | 4.00 | 8.00 |
| 784 774 033 | 3.3 | | 0.042 | 0.060 | 3.70 | 7.50 |
| 784 774 047 | 4.7 | | 0.056 | 0.071 | 3.00 | 5.50 |
| 784 774 068 | 6.8 | | 0.071 | 0.082 | 2.40 | 4.50 |
| 784 774 10 | 10 | | 0.078 | 0.100 | 2.20 | 2.50 |
| 784 774 112 | 12 | | 0.082 | 0.110 | 2.00 | 1.94 |
| 784 774 115 | 15 | | 0.089 | 0.140 | 1.53 | 1.90 |
| 784 774 118 | 18 | | 0.104 | 0.150 | 1.45 | 1.69 |
| 784 774 122 | 22 | | 0.109 | 0.180 | 1.28 | 1.53 |
| 784 774 127 | 27 | 0.133 | 0.200 | 1.19 | 1.40 | |
| 784 774 133 | 33 | ±15 | 0.150 | 0.230 | 1.09 | 1.17 |
| 784 774 139 | 39 | | 0.215 | 0.320 | 0.94 | 1.10 |
| 784 774 147 | 47 | | 0.260 | 0.370 | 0.86 | 1.00 |
| 784 774 156 | 56 | ±10 | 0.298 | 0.420 | 0.77 | 0.90 |
| 784 774 168 | 68 | | 0.313 | 0.460 | 0.64 | 0.86 |
| 784 774 182 | 82 | | 0.475 | 0.600 | 0.60 | 0.72 |
| 784 774 20 | 100 | | 0.510 | 0.650 | 0.57 | 0.68 |
| 784 774 212 | 120 | | 0.660 | 0.930 | 0.49 | 0.63 |
| 784 774 215 | 150 | | 0.720 | 1.100 | 0.46 | 0.54 |
| 784 774 218 | 180 | | 0.850 | 1.380 | 0.42 | 0.50 |
| 784 774 222 | 220 | | 0.945 | 1.570 | 0.41 | 0.47 |

Dimensions (in mm): Size 5848



Inductance vs. rated current: Size 5848



Land pattern (in mm): Size 5848



WE-PD2A

SMD Power Inductor

Size 7850

Electrical properties

| Order Code | L (µH) | Tolerance (%) | R _{DC} typ. (Ω) | R _{DC} max. (Ω) | I _R (A) | I _{sat} (A) | |
|-------------|--------|---------------|--------------------------|--------------------------|--------------------|----------------------|------|
| 784 775 012 | 1.2 | ±20 | 0.005 | 0.006 | 6.18 | 8.00 | |
| 784 775 022 | 2.2 | | 0.008 | 0.010 | 6.00 | 6.00 | |
| 784 775 033 | 3.3 | | 0.012 | 0.014 | 4.90 | 4.90 | |
| 784 775 047 | 4.7 | | 0.016 | 0.019 | 4.50 | 4.50 | |
| 784 775 056 | 5.6 | | 0.018 | 0.022 | 4.00 | 4.00 | |
| 784 775 068 | 6.8 | | 0.022 | 0.026 | 3.70 | 3.80 | |
| 784 775 082 | 8.2 | | 0.024 | 0.029 | 3.20 | 3.20 | |
| 784 775 110 | 10 | | ±10 | 0.040 | 0.070 | 2.30 | 2.95 |
| 784 775 112 | 12 | | | 0.042 | 0.080 | 2.18 | 2.23 |
| 784 775 115 | 15 | | | 0.044 | 0.090 | 1.93 | 2.20 |
| 784 775 118 | 18 | 0.053 | | 0.100 | 1.89 | 2.14 | |
| 784 775 122 | 22 | 0.065 | | 0.110 | 1.76 | 1.81 | |
| 784 775 127 | 27 | 0.074 | | 0.120 | 1.48 | 1.62 | |
| 784 775 133 | 33 | 0.089 | | 0.130 | 1.35 | 1.47 | |
| 784 775 139 | 39 | 0.116 | | 0.160 | 1.25 | 1.33 | |
| 784 775 147 | 47 | 0.134 | | 0.180 | 1.17 | 1.24 | |
| 784 775 168 | 68 | 0.218 | | 0.280 | 0.99 | 1.05 | |
| 784 775 182 | 82 | 0.248 | 0.370 | 0.90 | 0.95 | | |
| 784 775 20 | 100 | 0.281 | 0.430 | 0.77 | 0.86 | | |
| 784 775 212 | 120 | 0.340 | 0.470 | 0.67 | 0.81 | | |
| 784 775 215 | 150 | 0.467 | 0.640 | 0.60 | 0.71 | | |
| 784 775 218 | 180 | 0.574 | 0.710 | 0.55 | 0.57 | | |
| 784 775 222 | 220 | 0.614 | 0.960 | 0.51 | 0.56 | | |
| 784 775 227 | 270 | 0.699 | 1.110 | 0.47 | 0.51 | | |
| 784 775 233 | 330 | 0.980 | 1.260 | 0.43 | 0.48 | | |
| 784 775 239 | 390 | 1.151 | 1.770 | 0.38 | 0.43 | | |
| 784 775 247 | 470 | 1.370 | 1.960 | 0.360 | 0.38 | | |

Dimensions (in mm)

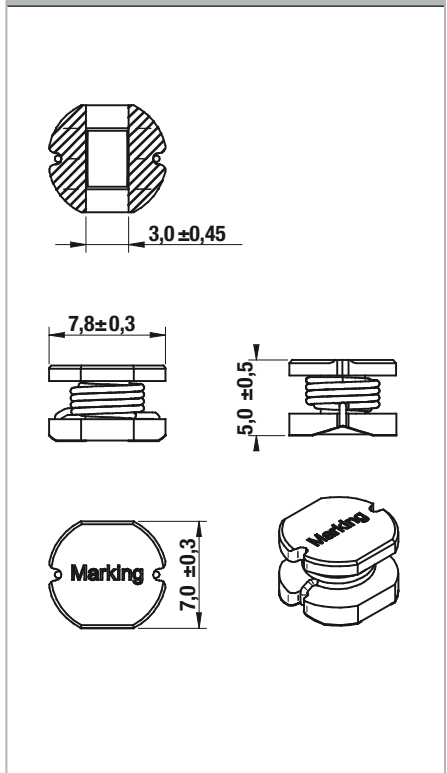

Inductance vs. rated current

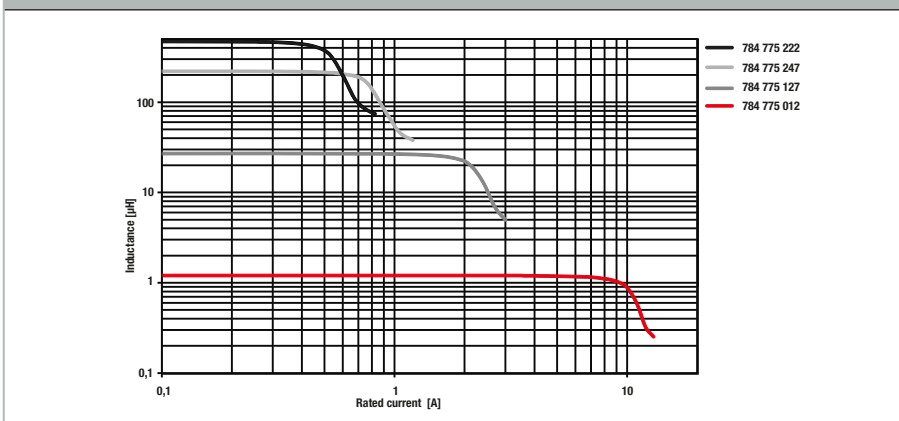

Land pattern (in mm)

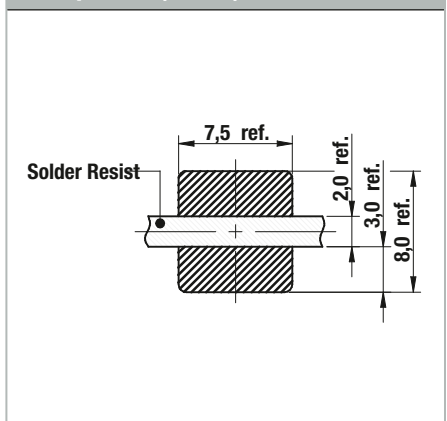

WE-PD2A SMD Power Inductor

Size 1054



| Electrical properties | | | | | | |
|-----------------------|--------|---------------|--------------------------|--------------------------|--------------------|----------------------|
| Order Code | L (µH) | Tolerance (%) | R _{DC} typ. (Ω) | R _{DC} max. (Ω) | I _R (A) | I _{sat} (A) |
| 784 776 012 | 1.2 | ±20 | 0.004 | 0.0048 | 7.40 | 11.00 |
| 784 776 022 | 2.2 | | 0.007 | 0.0078 | 7.00 | 8.00 |
| 784 776 033 | 3.3 | | 0.009 | 0.0102 | 6.00 | 7.00 |
| 784 776 047 | 4.7 | | 0.012 | 0.014 | 5.00 | 6.00 |
| 784 776 056 | 5.6 | | 0.015 | 0.018 | 4.80 | 5.50 |
| 784 776 068 | 6.8 | | 0.016 | 0.019 | 4.40 | 5.00 |
| 784 776 082 | 8.2 | | 0.020 | 0.024 | 4.20 | 4.25 |
| 784 776 10 | 10 | | 0.028 | 0.060 | 2.98 | 3.24 |
| 784 776 112 | 12 | | 0.033 | 0.070 | 2.72 | 3.15 |
| 784 776 115 | 15 | | 0.034 | 0.080 | 2.47 | 2.88 |
| 784 776 118 | 18 | | 0.043 | 0.090 | 2.36 | 2.43 |
| 784 776 122 | 22 | | 0.051 | 0.100 | 2.04 | 2.07 |
| 784 776 127 | 27 | | 0.063 | 0.110 | 1.95 | 1.98 |
| 784 776 133 | 33 | | 0.083 | 0.120 | 1.78 | 1.89 |
| 784 776 139 | 39 | | 0.088 | 0.140 | 1.62 | 1.80 |
| 784 776 147 | 47 | 0.095 | 0.170 | 1.45 | 1.62 | |
| 784 776 156 | 56 | 0.112 | 0.190 | 1.36 | 1.53 | |
| 784 776 168 | 68 | 0.138 | 0.220 | 1.19 | 1.49 | |
| 784 776 182 | 82 | 0.150 | 0.250 | 1.11 | 1.17 | |
| 784 776 20 | 100 | ±10 | 0.200 | 0.350 | 1.02 | 1.10 |
| 784 776 212 | 120 | | 0.243 | 0.400 | 0.94 | 0.99 |
| 784 776 215 | 150 | | 0.300 | 0.470 | 0.81 | 0.90 |
| 784 776 218 | 180 | | 0.320 | 0.630 | 0.76 | 0.78 |
| 784 776 222 | 220 | | 0.451 | 0.730 | 0.67 | 0.77 |
| 784 776 227 | 270 | | 0.500 | 0.970 | 0.62 | 0.68 |
| 784 776 233 | 330 | | 0.750 | 1.150 | 0.52 | 0.59 |
| 784 776 239 | 390 | | 0.794 | 1.300 | 0.49 | 0.54 |
| 784 776 247 | 470 | | 0.969 | 1.480 | 0.44 | 0.50 |



WE-MAIA

SMD Metal Alloy Power Inductor

Size 2506 / Size 2508



Characteristics

- Magnetic iron alloy allows high rated currents
- Compact design
- Magnetically shielded
- High current capability and handles high transient current spikes
- Low acoustic noise and low leakage flux noise
- Operating temperature: -40 °C to 125 °C

NEW!



**4-times higher saturation current
Best efficiency Minimized package**

Applications

- DC/DC-converter for high current power supplies
- DC/DC-converter for Field Programmable Gate Array (FPGA)
- POL-converters
- Portable power like PDA, digital camera
- Mainboards/graphic cards
- Battery powered devices
- Wireless communication devices
- Power supplies for smartphones, tablet PCs and other mobile devices

Electrical properties: Size 2506

| Order Code | L (μH) | Tolerance (%) | I _R (A) | I _{sat} (A) | R _{DC typ.} (mΩ) | R _{DC max.} (mΩ) |
|-----------------|--------|---------------|--------------------|----------------------|---------------------------|---------------------------|
| 784 383 210 047 | 0.47 | ±30 | 2.2 | 3.7 | 76.0 | 95.0 |
| 784 383 210 10 | 1.0 | | 1.25 | 2.5 | 163.0 | 196.0 |

I_R referring to 40 K heating above ambient temperature
I_{sat} referring to inductance loss of 20% typical

Dimensions (in mm)

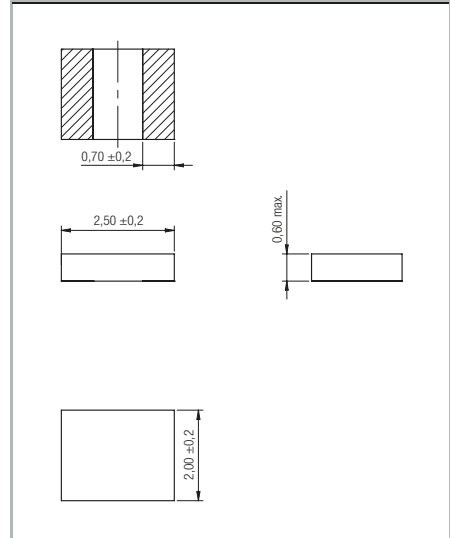

Soldering Pad (in mm)

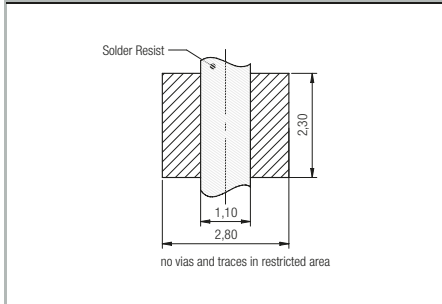

Electrical properties: Size 2508

| Order Code | L (μH) | Tolerance (%) | I _R (A) | I _{sat} (A) | R _{DC typ.} (mΩ) | R _{DC max.} (mΩ) |
|-----------------|--------|---------------|--------------------|----------------------|---------------------------|---------------------------|
| 784 383 220 047 | 0.47 | ±30 | 2.25 | 4.4 | 70.0 | 87.0 |
| 784 383 220 10 | 1.0 | | 1.75 | 3.35 | 107.0 | 133.0 |
| 784 383 220 22 | 2.2 | | 1.34 | 2.2 | 252.0 | 302.0 |

I_R referring to 40 K heating above ambient temperature
I_{sat} referring to inductance loss of 20% typical

Dimensions (in mm)

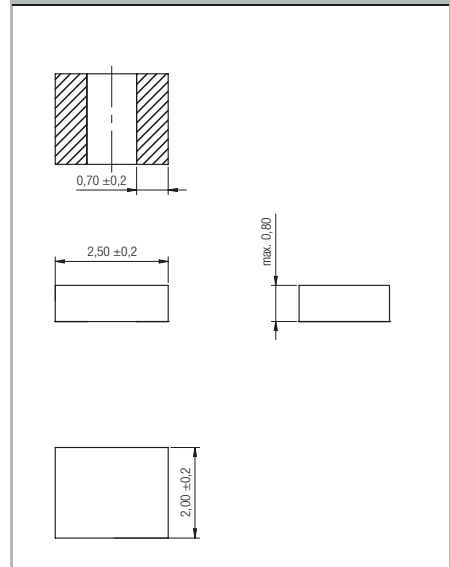

Soldering Pad (in mm)

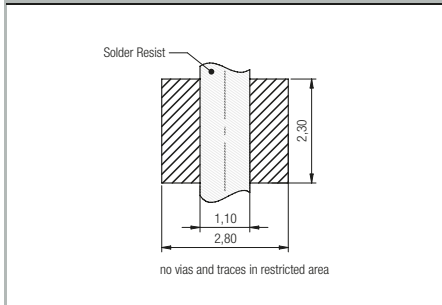

WE-MAIA

SMD Metal Alloy Power Inductor

Size 2510 / Size 3010



| Electrical properties: Size 2510 | | | | | | |
|----------------------------------|--------|---------------|--------------------|----------------------|---------------------------|---------------------------|
| Order Code | L (μH) | Tolerance (%) | I _R (A) | I _{sat} (A) | R _{DC typ.} (mΩ) | R _{DC max.} (mΩ) |
| 784 383 230 033 | 0.33 | ±30 | 3.4 | 6.2 | 29.0 | 38.0 |
| 784 383 230 047 | 0.47 | ±30 | 3.2 | 5.5 | 37.0 | 48.0 |
| 784 383 230 068 | 0.68 | ±30 | 3.1 | 4.7 | 46.0 | 60.0 |
| 784 383 230 082 | 0.82 | ±30 | 2.6 | 4.25 | 53.0 | 69.0 |
| 784 383 230 10 | 1.0 | ±20 | 2.5 | 4.0 | 63.0 | 75.0 |
| 784 383 230 12 | 1.2 | ±20 | 1.9 | 3.8 | 82.0 | 106 |
| 784 383 230 15 | 1.5 | ±20 | 1.8 | 3.5 | 92.0 | 110 |
| 784 383 230 22 | 2.2 | ±20 | 1.3 | 2.5 | 147 | 176 |
| 784 383 230 33 | 3.3 | ±20 | 1.25 | 2.1 | 220 | 264 |
| 784 383 230 47 | 4.7 | ±20 | 0.94 | 1.75 | 338 | 388 |
| 784 383 230 68 | 6.8 | ±20 | 0.85 | 1.55 | 563 | 648 |
| 784 383 230 82 | 8.2 | ±20 | 0.7 | 1.45 | 646 | 743 |
| 784 383 231 00 | 10.0 | ±20 | 0.6 | 1.35 | 733 | 843 |

I_R referring to 40 K heating above ambient temperature
I_{sat} referring to inductance loss of 20% typical



| Electrical properties: Size 3010 | | | | | | |
|----------------------------------|--------|---------------|--------------------|----------------------|---------------------------|---------------------------|
| Order Code | L (μH) | Tolerance (%) | I _R (A) | I _{sat} (A) | R _{DC typ.} (mΩ) | R _{DC max.} (mΩ) |
| 784 383 330 22 | 2.2 | ±20 | 1.4 | 3.9 | 150 | 172 |
| 784 383 330 33 | 3.3 | | 1.1 | 2.95 | 232 | 266 |
| 784 383 330 47 | 4.7 | | 0.9 | 2.4 | 305 | 350 |

I_R referring to 40 K heating above ambient temperature
I_{sat} referring to inductance loss of 20% typical



WE-MAIA

SMD Metal Alloy Power Inductor

Size 3012

Electrical properties: Size 3012

| Order Code | L (μH) | Tolerance (%) | I_R (A) | I_{sat} (A) | $R_{\text{DC typ.}}$ ($\text{m}\Omega$) | $R_{\text{DC max.}}$ ($\text{m}\Omega$) |
|-----------------|------------------------|------------------|--------------|-------------------------|--|--|
| 784 383 340 033 | 0.33 | ± 30 | 4.8 | 11.1 | 13.2 | 15.8 |
| 784 383 340 047 | 0.47 | ± 30 | 4.0 | 9.4 | 16.6 | 19.9 |
| 784 383 340 056 | 0.56 | ± 30 | 3.6 | 8.5 | 27.0 | 32.4 |
| 784 383 340 068 | 0.68 | ± 20 | 3.5 | 7.7 | 28.7 | 34.4 |
| 784 383 340 10 | 1.0 | ± 20 | 2.75 | 6.6 | 41.2 | 50.5 |
| 784 383 340 12 | 1.2 | ± 20 | 2.65 | 6.0 | 46.8 | 56.1 |
| 784 383 340 15 | 1.5 | ± 20 | 2.0 | 5.7 | 75.3 | 90.3 |
| 784 383 340 22 | 2.2 | ± 20 | 1.80 | 5.0 | 100 | 115.0 |
| 784 383 340 33 | 3.3 | ± 20 | 1.4 | 4.0 | 136.8 | 164.2 |
| 784 383 340 47 | 4.7 | ± 20 | 1.1 | 3.8 | 222.6 | 256 |
| 784 383 340 56 | 5.6 | ± 20 | 1.0 | 3.0 | 338.3 | 389 |
| 784 383 340 68 | 6.8 | ± 20 | 0.88 | 2.7 | 368.2 | 423.4 |

I_R referring to 40 K heating above ambient temperature
 I_{sat} referring to inductance loss of 20% typical

Dimensions (in mm)

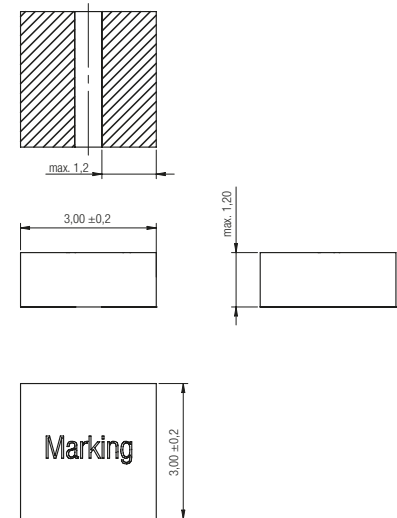

Soldering Pad (in mm)

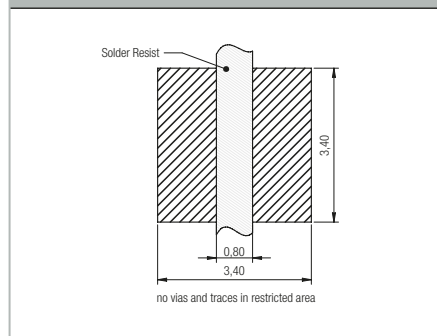

WE-MAIA

SMD Metal Alloy Power Inductor

Size 3015



| Electrical properties: Size 3015 | | | | | | |
|----------------------------------|------------------------|------------------|--------------|-------------------------|--|--|
| Order Code | L (μH) | Tolerance (%) | I_R (A) | I_{sat} (A) | $R_{\text{DC typ.}}$ ($\text{m}\Omega$) | $R_{\text{DC max.}}$ ($\text{m}\Omega$) |
| 784 383 350 047 | 0.47 | $\pm 30\%$ | 4.6 | 5.8 | 20.0 | 23.0 |
| 784 383 350 068 | 0.68 | $\pm 30\%$ | 4.1 | 8.1 | 25.0 | 30.0 |
| 784 383 350 082 | 0.82 | $\pm 30\%$ | 3.5 | 7.0 | 30 | 35.0 |
| 784 383 350 10 | 1.0 | $\pm 20\%$ | 2.7 | 4.5 | 39.0 | 47.0 |
| 784 383 350 22 | 2.2 | $\pm 20\%$ | 1.8 | 3.5 | 94.0 | 108 |
| 784 383 350 33 | 3.3 | $\pm 20\%$ | 1.7 | 3.2 | 114 | 131 |
| 784 383 350 47 | 4.7 | $\pm 20\%$ | 1.5 | 2.8 | 141 | 162 |
| 784 383 350 68 | 6.8 | $\pm 20\%$ | 1.1 | 2.4 | 250 | 287 |
| 784 383 351 00 | 10.0 | $\pm 20\%$ | 0.85 | 2.0 | 446 | 513 |
| 784 383 351 50 | 15.0 | $\pm 20\%$ | 0.65 | 1.71 | 720 | 830 |
| 784 383 352 20 | 22.0 | $\pm 20\%$ | 0.60 | 1.60 | 940 | 1040 |
| 784 383 353 30 | 33.0 | $\pm 20\%$ | 0.50 | 1.30 | 1210 | 1330 |
| 784 383 354 70 | 47.0 | $\pm 20\%$ | 0.39 | 1.18 | 2090 | 2300 |

I_R referring to 40 K heating above ambient temperature
 I_{sat} referring to inductance loss of 20% typical



Design Kit WE-CBA

SMD EMI Suppression Ferrite Bead

Order Code 782 792, Version 1.1



Characteristics

- Reliable Ni-Sn electrodes
- High rated current up to 5 A
- Recommended soldering: Reflow
- Operating temperature: -55 °C to +125 °C

Applications

- Perfect as data lined filter and for uncoupling of distribution voltage

Electrical properties

| Order Code | Size | Z @ 100 MHz (Ω) | I _R (mA) | R _{DC} (Ω) | Type of Application | |
|-------------|------|-----------------|---------------------|---------------------|---------------------|--------------|
| 782 422 101 | 0402 | 100 | 500 | 0.300 | Wide Band | |
| 782 422 221 | | 220 | 400 | 0.300 | Wide Band | |
| 782 422 331 | | 330 | 300 | 0.500 | Wide Band | |
| 782 422 511 | | 510 | 200 | 0.800 | Wide Band | |
| 782 422 601 | | 600 | 200 | 0.800 | Wide Band | |
| 782 422 102 | | 1000 | 200 | 1.000 | Wide Band | |
| 782 423 100 | | 10 | 1500 | 0.030 | High Current | |
| 782 423 700 | 70 | 1000 | 0.090 | High Current | | |
| 782 631 101 | 0603 | 100 | 500 | 0.200 | High Speed | |
| 782 631 331 | | 330 | 400 | 0.250 | High Speed | |
| 782 631 182 | | 1800 | 100 | 0.750 | High Speed | |
| 782 632 620 | | 62 | 500 | 0.150 | Wide Band | |
| 782 632 121 | | 120 | 500 | 0.200 | Wide Band | |
| 782 632 181 | | 180 | 500 | 0.200 | Wide Band | |
| 782 632 511 | | 510 | 300 | 0.350 | Wide Band | |
| 782 632 102 | | 1000 | 200 | 0.500 | Wide Band | |
| 782 633 620 | | 62 | 2500 | 0.040 | High Current | |
| 782 633 601 | | 600 | 1000 | 0.200 | High Current | |
| 782 851 102 | 0805 | 1000 | 300 | 0.350 | High Speed | |
| 782 851 202 | | 2200 | 200 | 0.450 | High Speed | |
| 782 853 200 | | 20 | 5000 | 0.008 | High Current | |
| 782 853 270 | | 27 | 4000 | 0.015 | High Current | |
| 782 853 680 | | 68 | 3000 | 0.025 | High Current | |
| 782 853 910 | | 91 | 2000 | 0.060 | High Current | |
| 782 853 121 | | 120 | 2500 | 0.035 | High Current | |
| 782 583 221 | | 220 | 2000 | 0.050 | High Current | |
| 782 853 561 | | 560 | 1500 | 0.100 | High Current | |
| 782 853 112 | | 1100 | 800 | 0.300 | High Current | |
| 752 853 152 | | 1500 | 700 | 0.350 | High Current | |
| 782 762 301 | | 1206 | 300 | 500 | 0.100 | Wide Band |
| 782 763 820 | | | 82 | 3000 | 0.025 | High Current |
| 782 763 621 | 620 | | 1500 | 0.100 | High Current | |
| 782 763 102 | 1000 | | 1000 | 0.300 | High Current | |
| 782 963 560 | 1806 | 56 | 5000 | 0.008 | High Current | |
| 782 963 820 | | 82 | 3500 | 0.020 | High Current | |

Design Kit WE-AEFA

Axial EMI Suppression Ferrite

Order Code 782 013, Version 1.1



Characteristics

- Ferrite core made of NiZn, a material which works in a wide frequency range
- Many different types for the best possible interference suppression
- Operating temperature: -55 °C up to +150 °C

Applications

- In general for: wires, coaxial cables, wire-wrapping cables, multiconductor wires
- Data and signal lines
- On board power supply line
- Multimedia cable interfaces
- Various, other cable interfaces

Electrical properties

| Order Code | OD (mm) | ID (mm) | H (mm) | Cable Diameter (mm) | Z @ 25 MHz 1 turn (Ω) | Z @ 100 MHz 1 turn (Ω) |
|-----------------|---------|---------|--------|---------------------|--------------------------|---------------------------|
| 782 013 033 150 | 12.0 | 3.55 | 15.0 | ≤ 3.3 | 150 | 205 |
| 782 013 044 095 | 9.5 | 4.75 | 9.5 | ≤ 4.4 | 60 | 84 |
| 782 013 046 185 | 11.5 | 5.0 | 18.5 | ≤ 4.6 | 135 | 186 |
| 782 013 046 250 | 11.5 | 5.0 | 25.0 | ≤ 4.6 | 185 | 255 |
| 782 013 057 450 | 12.0 | 6.1 | 45.0 | ≤ 5.7 | 255 | 370 |
| 782 013 059 285 | 14.0 | 6.3 | 28.5 | ≤ 5.9 | 195 | 270 |
| 782 013 068 250 | 14.0 | 7.2 | 25.0 | ≤ 6.8 | 150 | 210 |
| 782 013 069 155 | 12.0 | 7.3 | 15.5 | ≤ 6.9 | 70 | 100 |
| 782 013 069 285 | 15.5 | 7.3 | 28.5 | ≤ 6.9 | 190 | 270 |
| 782 013 076 285 | 16.0 | 8.0 | 28.5 | ≤ 7.6 | 170 | 240 |
| 782 013 076 508 | 16.0 | 8.0 | 50.8 | ≤ 7.6 | 325 | 460 |
| 782 013 079 285 | 14.0 | 8.2 | 28.5 | ≤ 7.9 | 140 | 200 |
| 782 013 086 280 | 16.0 | 9.0 | 28.0 | ≤ 8.6 | 140 | 205 |
| 782 013 091 285 | 17.5 | 9.5 | 28.5 | ≤ 9.1 | 150 | 220 |
| 782 013 100 280 | 15.5 | 10.5 | 28.0 | ≤ 10.0 | 100 | 150 |
| 782 013 110 508 | 19.0 | 11.5 | 50.8 | ≤ 11.0 | 235 | 345 |
| 782 013 125 280 | 19.0 | 13.0 | 28.0 | ≤ 12.5 | 95 | 150 |
| 782 013 125 285 | 26.0 | 13.0 | 28.5 | ≤ 12.5 | 170 | 240 |
| 782 013 150 285 | 26.0 | 15.5 | 28.5 | ≤ 15.0 | 130 | 190 |

Design Kit WE-PDA

SMD Power Inductor

Order Code 784 770 & 784 778, Version 1.1



Characteristics

- Wire connection: welding technology
- Operating Temperature -40 °C up to +125 °C
- Highest possible current loading for SMD Inductors
- Magnetically shielded version which results in a low leakage field
- High storage capacity
- Low self-losses
- Core Material: NiZn

Applications

- Multimedia applications
- Switching regulators with low operating voltages (Computer, Notebook, smart phones)
- Integrated DC/DC-converter
- Perfect suitable for switching regulators with extremely high efficiency (> 86%)

Electrical properties: Order Code 784 770

| Order Code | Size | L (µH) | R _{DC} (Ω) | I _R (A) | I _{sat} (A) |
|---------------|------|--------|---------------------|--------------------|----------------------|
| 784 771 010 | 1260 | 1 | 8.50 | 9.00 | 16.50 |
| 784 771 022 | | 2.2 | 12.50 | 7.20 | 10.50 |
| 784 771 033 | | 3.3 | 14.50 | 6.50 | 9.00 |
| 784 771 047 | | 4.7 | 17.50 | 6.20 | 8.00 |
| 784 771 068 | | 6.8 | 21.50 | 5.50 | 6.00 |
| 784 771 082 | | 8.2 | 24.00 | 5.05 | 5.50 |
| 784 771 100 | | 10 | 26.50 | 5.00 | 5.25 |
| 784 771 220 | | 22 | 40.00 | 3.20 | 3.50 |
| 784 771 470 | | 47 | 77.00 | 2.30 | 2.50 |
| 784 771 101 | | 100 | 174 | 1.50 | 1.70 |
| 784 771 221 | | 220 | 348 | 0.99 | 1.10 |
| 784 771 102 | | 1000 | 1705 | 0.48 | 0.53 |
| 784 770 10 | 1280 | 1 | 9.00 | 8.30 | 22.00 |
| 784 770 22 | | 2.2 | 14.50 | 7.00 | 15.00 |
| 784 770 33 | | 3.3 | 17.00 | 6.60 | 12.00 |
| 784 770 47 | | 4.7 | 20.00 | 6.00 | 11.00 |
| 784 770 68 | | 6.8 | 25.00 | 5.20 | 8.50 |
| 784 770 100 | | 10 | 31.00 | 5.00 | 6.80 |
| 784 770 220 | | 22 | 44.50 | 4.00 | 4.70 |
| 784 770 470 | | 47 | 71.00 | 3.10 | 3.40 |
| 784 770 101 | | 100 | 144.00 | 2.10 | 2.30 |
| 784 770 471 | | 470 | 570.00 | 0.80 | 1.00 |
| 784 770 102 | | 1000 | 1200.00 | 0.72 | 0.80 |
| 784 770 901 0 | | 1210 | 1 | 8.50 | 9.20 |
| 784 770 902 2 | 2.2 | | 14.50 | 7.50 | 16.00 |
| 784 770 903 3 | 3.3 | | 17.00 | 7.00 | 13.50 |
| 784 770 904 7 | 4.7 | | 19.00 | 6.00 | 11.00 |
| 784 770 906 8 | 6.8 | | 24.00 | 5.50 | 9.00 |
| 784 770 910 0 | 10 | | 30.00 | 5.00 | 7.50 |
| 784 770 922 0 | 22 | | 44.00 | 4.30 | 5.00 |
| 784 770 947 0 | 47 | | 67.00 | 3.20 | 3.50 |
| 784 770 910 1 | 100 | | 120.00 | 2.20 | 2.40 |
| 784 770 922 1 | 220 | | 245.00 | 1.45 | 1.60 |
| 784 770 947 1 | 470 | | 490.00 | 0.90 | 1.10 |
| 784 770 910 2 | 1000 | | 1060 | 0.63 | 0.70 |

Electrical properties: Order Code 784 778

| Order Code | Size | L (µH) | R _{DC} (Ω) | I _R (A) | I _{sat} (A) |
|-------------|------|--------|---------------------|--------------------|----------------------|
| 784 777 010 | 7332 | 1 | 39 | 3.70 | 8.00 |
| 784 777 022 | | 2.2 | 61 | 2.70 | 5.25 |
| 784 777 033 | | 3.3 | 70 | 2.50 | 4.70 |
| 784 777 047 | | 4.7 | 84 | 2.35 | 3.70 |
| 784 777 068 | | 6.8 | 98 | 2.20 | 3.20 |
| 784 777 082 | | 8.2 | 117 | 2.00 | 2.80 |
| 784 777 100 | | 10 | 126 | 1.90 | 2.60 |
| 784 777 220 | | 22 | 215 | 1.40 | 1.80 |
| 784 777 470 | | 47 | 300 | 1.15 | 1.25 |
| 784 777 101 | | 100 | 470 | 0.72 | 0.80 |
| 784 777 221 | | 220 | 2720 | 0.50 | 0.55 |
| 784 777 471 | | 470 | 5750 | 0.35 | 0.38 |
| 784 777 102 | 1000 | 5760 | 0.25 | 0.28 | |
| 784 778 010 | 7345 | 1 | 36 | 3.50 | 7.00 |
| 784 778 022 | | 2.2 | 50 | 3.10 | 5.00 |
| 784 778 033 | | 3.3 | 65 | 2.65 | 3.70 |
| 784 778 047 | | 4.7 | 79 | 2.40 | 3.10 |
| 784 778 068 | | 6.8 | 107 | 2.30 | 2.50 |
| 784 778 082 | | 8.2 | 103 | 2.20 | 2.40 |
| 784 778 100 | | 10 | 126 | 1.85 | 2.20 |
| 784 778 220 | | 22 | 187 | 1.55 | 1.60 |
| 784 778 470 | | 47 | 348 | 1.10 | 1.05 |
| 784 778 101 | | 100 | 720 | 0.72 | 0.75 |
| 784 778 221 | | 220 | 1620 | 0.48 | 0.50 |
| 784 778 471 | | 470 | 3300 | 0.30 | 0.35 |
| 784 778 102 | 1000 | 7200 | 0.23 | 0.25 | |



Design Kit WE-PD2A

SMD Power Inductor

Order Code 784 773 & 784 775, Version 1.1



Characteristics

- Open size
- Current capability up to 14 A
- Operating temperature: -40 °C to +125 °C
- Recommended solder profile: Reflow

Applications

- Switching regulators with low operating voltage (navigation system, air conditioning, entertainment, park assistance control)
- Integrated DC/DC-converter
- Perfectly suitable for switching regulators with extremely high efficiency

Electrical properties: Order Code 784 773

| Order Code | Size | L (µH) | R _{DC} (Ω) | I _R (A) | I _{sat} (A) | |
|-------------|------|--------|---------------------|--------------------|----------------------|------|
| 784 773 0 | 4532 | 1.00 | 0.014 | 4.0 | 5.72 | |
| 784 773 018 | | 1.8 | 0.028 | 2.70 | 3.60 | |
| 784 773 022 | | 2.2 | 0.034 | 2.50 | 3.38 | |
| 784 773 033 | | 3.3 | 0.041 | 2.00 | 2.88 | |
| 784 773 039 | | 3.9 | 0.054 | 1.88 | 2.57 | |
| 784 773 047 | | 4.7 | 0.059 | 1.82 | 2.46 | |
| 784 773 068 | | 6.8 | 0.076 | 1.54 | 2.10 | |
| 784 773 10 | | 10 | 0.118 | 1.45 | 1.74 | |
| 784 773 112 | | 12 | 0.156 | 1.28 | 1.62 | |
| 784 773 115 | | 15 | 0.204 | 1.20 | 1.46 | |
| 784 773 118 | | 18 | 0.225 | 1.10 | 1.29 | |
| 784 773 122 | | 22 | 0.261 | 1.00 | 1.22 | |
| 784 773 127 | | 27 | 0.328 | 0.94 | 1.00 | |
| 784 773 133 | | 33 | 0.370 | 0.86 | 0.90 | |
| 784 773 147 | | 47 | 0.523 | 0.68 | 0.77 | |
| 784 773 168 | | 68 | 0.754 | 0.56 | 0.68 | |
| 784 774 022 | | 5848 | 2.2 | 0.026 | 4.60 | 8.20 |
| 784 774 027 | | | 2.7 | 0.032 | 4.00 | 8.00 |
| 784 774 033 | 3.3 | | 0.042 | 3.70 | 7.50 | |
| 784 774 047 | 4.7 | | 0.056 | 3.00 | 5.50 | |
| 784 774 068 | 6.8 | | 0.071 | 2.40 | 5.00 | |
| 784 774 10 | 10 | | 0.078 | 2.20 | 2.5 | |
| 784 774 112 | 12 | | 0.082 | 2.00 | 1.94 | |
| 784 774 115 | 15 | | 0.089 | 1.53 | 1.90 | |
| 784 774 118 | 18 | | 0.104 | 1.45 | 1.69 | |
| 784 774 122 | 22 | | 0.109 | 1.28 | 1.53 | |
| 784 774 127 | 27 | | 0.133 | 1.19 | 1.40 | |
| 784 774 133 | 33 | | 0.150 | 1.09 | 1.17 | |
| 784 774 147 | 47 | | 0.260 | 0.86 | 1.00 | |
| 784 774 156 | 56 | | 0.298 | 0.77 | 0.90 | |
| 784 774 168 | 68 | | 0.313 | 0.64 | 0.86 | |
| 784 774 182 | 82 | | 0.475 | 0.60 | 0.72 | |
| 784 774 20 | 100 | | 0.510 | 0.57 | 0.68 | |
| 784 774 215 | 150 | | 0.720 | 0.46 | 0.54 | |
| 784 774 222 | 220 | | 0.945 | 0.41 | 0.47 | |

Electrical properties: Order Code 784 775

| Order Code | Size | L (µH) | R _{DC} (Ω) | I _R (A) | I _{sat} (A) |
|-------------|------|--------|---------------------|--------------------|----------------------|
| 784 775 10 | 7850 | 10 | 0.040 | 2.30 | 2.95 |
| 784 775 112 | | 12 | 0.042 | 2.18 | 2.23 |
| 784 775 115 | | 15 | 0.044 | 1.93 | 2.20 |
| 784 775 118 | | 18 | 0.053 | 1.89 | 2.14 |
| 784 775 122 | | 22 | 0.065 | 1.76 | 1.81 |
| 784 775 127 | | 27 | 0.074 | 1.48 | 1.62 |
| 784 775 133 | | 33 | 0.130 | 1.35 | 1.47 |
| 784 775 139 | | 39 | 0.116 | 1.25 | 1.33 |
| 784 775 147 | | 47 | 0.134 | 1.17 | 1.24 |
| 784 775 168 | | 68 | 0.218 | 0.99 | 1.05 |
| 784 775 182 | | 82 | 0.248 | 0.90 | 0.95 |
| 784 775 20 | | 100 | 0.281 | 0.77 | 0.86 |
| 784 775 215 | | 150 | 0.467 | 0.60 | 0.71 |
| 784 775 218 | | 180 | 0.574 | 0.55 | 0.57 |
| 784 775 222 | | 220 | 0.614 | 0.51 | 0.56 |
| 784 775 227 | | 270 | 0.699 | 0.47 | 0.51 |
| 784 775 239 | | 396 | 1.151 | 0.38 | 0.43 |
| 784 775 247 | | 470 | 1.370 | 0.36 | 0.38 |
| 784 776 10 | 1054 | 10 | 0.028 | 2.98 | 3.24 |
| 784 776 118 | | 18 | 0.043 | 2.36 | 2.43 |
| 784 776 122 | | 22 | 0.051 | 2.04 | 2.07 |
| 784 776 127 | | 27 | 0.063 | 1.95 | 1.98 |
| 784 776 133 | | 33 | 0.083 | 1.78 | 1.89 |
| 784 776 139 | | 39 | 0.088 | 1.62 | 1.80 |
| 784 776 147 | | 47 | 0.095 | 1.45 | 1.62 |
| 784 776 156 | | 56 | 0.112 | 1.36 | 1.53 |
| 784 776 168 | | 68 | 0.138 | 1.19 | 1.49 |
| 784 776 182 | | 82 | 0.150 | 1.11 | 1.17 |
| 784 776 20 | | 100 | 0.200 | 1.02 | 1.10 |
| 784 776 212 | | 120 | 0.243 | 0.94 | 0.99 |
| 784 776 215 | | 150 | 0.300 | 0.81 | 0.90 |
| 784 776 218 | | 180 | 0.320 | 0.76 | 0.78 |
| 784 776 222 | 220 | 0.451 | 0.67 | 0.77 | |
| 784 776 233 | 330 | 0.750 | 0.52 | 0.59 | |
| 784 776 247 | 470 | 0.969 | 0.44 | 0.50 | |

Design Kit WE-MAIA

SMD Metal Alloy Power Inductor

Order Code 784 3833 & 784 3832, Version 1.0



Characteristics

- Magnetic iron alloy allows high rated currents
- Compact design
- Magnetically shielded
- High current capability and handles high transient current spikes
- Low acoustic noise and low leakage flux noise
- Operating temperature: $-40\text{ }^{\circ}\text{C}$ to $125\text{ }^{\circ}\text{C}$

Applications

- DC/DC-converter for high current power supplies
- DC/DC-converter for Field Programmable Gate Array (FPGA)
- POL-converters
- Portable power like PDA, digital camera
- Mainboards/graphic cards
- Battery powered devices
- Wireless communication devices
- Power supplies for smartphones, tablet PCs and other mobile devices

Electrical properties: Order Code 784 3833

| Order Code | Size | L (μH) | I_R (A) | I_{sat} (A) | R_{DC} (Ω) | |
|-----------------|------|---------------------|-----------|----------------------|------------------------------|------|
| 784 383 330 22 | 3010 | 2.2 | 1.4 | 3.9 | 150 | |
| 784 383 330 33 | | 3.3 | 1.1 | 2.95 | 232 | |
| 784 383 330 47 | | 4.7 | 0.9 | 2.4 | 356 | |
| 784 383 340 033 | 3012 | 0.33 | 4.8 | 11.1 | 19.0 | |
| 784 383 340 047 | | 0.47 | 4.0 | 9.4 | 22.0 | |
| 784 383 340 056 | | 0.56 | 3.6 | 8.5 | 29.0 | |
| 784 383 340 068 | | 0.68 | 3.5 | 7.7 | 36.0 | |
| 784 383 340 10 | | 1.0 | 2.75 | 6.6 | 42.1 | |
| 784 383 340 12 | | 1.2 | 2.65 | 6.0 | 55.0 | |
| 784 383 340 15 | | 1.5 | 2.0 | 5.7 | 80.0 | |
| 784 383 340 22 | | 2.2 | 1.80 | 5.0 | 100 | |
| 784 383 340 33 | | 3.3 | 1.4 | 4.0 | 156.3 | |
| 784 383 340 47 | | 4.7 | 1.1 | 3.80 | 267.7 | |
| 784 383 340 56 | | 5.6 | 1.0 | 3.0 | 338.3 | |
| 784 383 340 68 | | 6.8 | 0.88 | 2.7 | 368.2 | |
| 784 383 350 10 | | 3015 | 1.0 | 2.7 | 4.5 | 39.0 |
| 784 383 350 22 | | | 2.2 | 1.8 | 3.5 | 94.0 |
| 784 383 350 33 | | | 3.3 | 1.7 | 3.2 | 114 |
| 784 383 350 47 | 4.7 | | 1.5 | 2.8 | 141 | |
| 784 383 350 68 | 6.8 | | 1.1 | 2.4 | 250 | |
| 784 383 351 00 | 10.0 | | 0.85 | 2.0 | 446 | |
| 784 383 351 50 | 15.0 | | 0.65 | 1.71 | 720 | |
| 784 383 352 20 | 22.0 | | 0.60 | 1.60 | 940 | |
| 784 383 353 30 | 33.0 | | 0.50 | 1.30 | 1210 | |
| 784 383 354 70 | 47.0 | | 0.39 | 1.18 | 2090 | |

Electrical properties: Order Code 784 3832

| Order Code | Size | L (μH) | I_R (A) | I_{sat} (A) | R_{DC} (Ω) |
|-----------------|------|---------------------|-----------|----------------------|------------------------------|
| 784 383 210 047 | 2506 | 0.47 | 2.2 | 3.7 | 76.0 |
| 784 383 210 10 | | 1.0 | 1.25 | 2.5 | 163.0 |
| 784 383 220 047 | 2508 | 0.47 | 2.25 | 4.4 | 70.0 |
| 784 383 220 10 | | 1.0 | 1.75 | 3.35 | 107.0 |
| 784 383 220 22 | | 2.2 | 1.34 | 2.2 | 252.0 |
| 784 383 230 033 | 2510 | 0.33 | 3.4 | 6.2 | 29.0 |
| 784 383 230 047 | | 0.47 | 3.2 | 5.5 | 37.0 |
| 784 383 230 068 | | 0.68 | 3.1 | 4.7 | 46.0 |
| 784 383 230 082 | | 0.82 | 2.6 | 4.25 | 53.0 |
| 784 383 230 10 | | 1.0 | 2.5 | 4.0 | 63.0 |
| 784 383 230 12 | | 1.2 | 1.9 | 3.8 | 82.0 |
| 784 383 230 15 | | 1.5 | 1.8 | 3.5 | 92.0 |
| 784 383 230 22 | | 2.2 | 1.3 | 2.5 | 147 |
| 784 383 230 33 | | 3.3 | 1.25 | 2.1 | 220 |
| 784 383 230 47 | | 4.7 | 0.94 | 1.75 | 338 |
| 784 383 230 68 | | 6.8 | 0.85 | 1.55 | 563 |
| 784 383 230 82 | | 8.2 | 0.7 | 1.45 | 646 |
| 784 383 231 00 | | 10.0 | 0.6 | 1.35 | 733 |

Total Quality Management



Analysis laboratory:

- XRF
- IFR
- Computer Tomography
- Hi Pot Tester up to 10kV
- Network Analyzer
- Oscilloscopes
- Precision LCR
- Source Meter
- Efficiency Measurement
- Twister Thermal Characterisation
- Moisture Balance
- Vision Measuring
- Profile Projector
- DSC
- Precision Magnetics Analyzer
- Hi Pot Tester 6,0kV
- Multiohmmeter
- Stereomicroscope 45x with camera
- Impedance Analyzer
- Reflow Oven
- Stereomicroscope 5000X

- Wetting Balance Machine
- Push and Pull Tester
- Wave Soldering
- DC Bias Measurement System
- Epoxy chamber
- PCB sample boards
- LED Measurement Equipment
- Grinding Machine
- Force Meter
- Mechanical tools
- Vibration up to 50g
- Mechanical Shock up to 100g

Reliability laboratory:

- Glow Wire Tester
- Salt Spray Chamber
- Flammability Tester
- Steamaging Machine
- Temperature Cycling Oven
- Thermal Shock Oven
- Thermal Oven



Cautions and Warnings

General:

All recommendations according to the general technical specifications of the datasheet have to be complied with.

The disposal and operation of the product within ambient conditions which probably alloy or harm the component surface has to be avoided.

If the product is potted in customer applications, the potting material might shrink during and after hardening. Accordingly to this the product is exposed to the pressure of the potting material with the effect that the ferrite body and termination is possibly damaged by this pressure and so the electrical as well as the mechanical characteristics are endanger to be affected. After the potting material is cured, the ferrite body and termination of the product have to be checked if any reduced electrical or mechanical functions or destructions have occurred.

The responsibility for the applicability of customer specific products and use in a particular customer design is always within the authority of the customer. All technical specifications for standard products do also apply for customer specific products.

Washing varnish agent that is used during the production to clean the application might damage or change the characteristics of the plating. The washing varnish agent could have a negative effect on the long term function of the product.

Direct mechanical impact to the product shall be prevented as the ferrite material of the ferrite body could flake or in the worst case it could break.

Product specific:

Follow all instructions mentioned in the datasheet, especially:

- The solder profile has to be complied with according to the technical reflow soldering specification, otherwise no warranty will be sustained.
- Wave soldering is only allowed after evaluation and approval.
- All products are supposed to be used before the end of the period of 12 months based on the product date-code, if not a 100% solderability can't be warranted.
- Violation of the technical product specifications such as exceeding the nominal rated current will result in the loss of warranty.





Information in this catalogue is subject to change. The process of continually improving our product range leads to changes in content. For new designs please refer to our latest data sheets on www.we-online.com or contact our field staff.







Looking for pricing, stock, or lifecycle information?

Click below to explore more details on WIN SOURCE:

-  [View 784771010 on WIN SOURCE](#)
-  [Wurth Electronics Inc Information](#)

Optimize Your Supply Chain with WIN SOURCE Solutions

-  Global Sourcing Solution
-  Obsolete Management
-  Cost Control Management
-  Shortage Management
-  Alternative Solution
-  Excess Inventory Management