

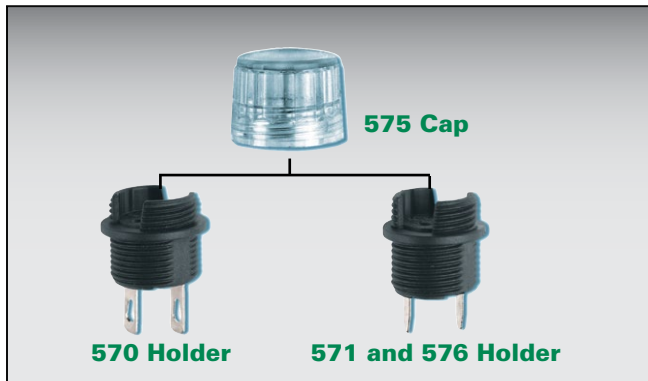

THE DATASHEET OF
57100000001



570/571/576 Series Fuse Holders with Cap for TE5/TR5 Type Fuses



Agency Approvals

Agency	Agency File Number		
	570 Series	571 Series	576 Series
	E14721		
	N/A	N/A	40024733

Dimensions units in mm (inch)

575 Cap

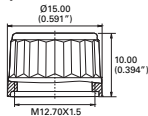

570 Holder (Panel Mounted)

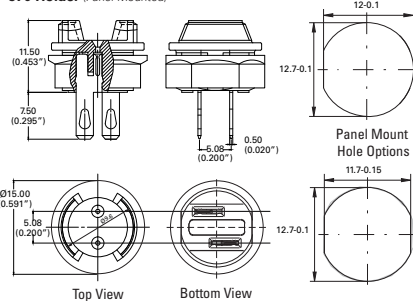

571 and 576 Holder (Circuit Board Mounted)

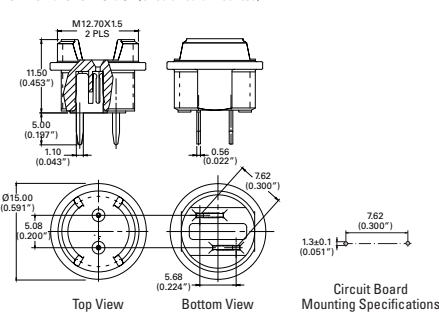

Product Characteristics

	570 Series	571 Series	576 Series
Compatible Fuses	TR5/TE5		
Materials	Holder: Black Thermoplastic, UL 94 V-0 Cap: Transparent Thermoplastic Polycarbonat PC, UL94 V-0 Metal Parts: Copper alloy Solderable tinned		
Rated Voltage	250V		
Max. Current/Power:	6.3 A/2.5W	6.3 A/2.5W	6.3 A/1.6W
Mounting	Panel Mounted: 12.7mm diameter D-hole or double D-hole. Admissible torque on plastic hex nut is 1.2Nm	Printed Circuit Board (PCB) Mounted: 7.62mm hole spacing for wave soldering	
Terminals	Solderable or 2.8mm quick connect – fits 0.5mm tab	Solderable pin terminals – fits 1.3mm hole	
Minimum Cross Section	Conductor - 2.5mm ²		Conducting path - 0.2mm ²
Unit Weight	2.2g (Holder) 0.94g (Cap)	1.6g (Holder) 0.94g (Cap)	1.6g (Holder) 0.94g (Cap)

Note: Refer to [Fuseology](#) for information on proper fuseholder re-rating.

Ordering Information

Catalog Number	Description	Packaging
5700000001	Holder: Panel Mount w/ Quick Connect Terminals	Bulk Pack 100
5710000001	Holder: PCB Mount w/ Solderable Pin Terminals - 2.5W Max	Bulk Pack 100
5760000001	Holder: PCB Mount w/ Solderable Pin Terminals - 1.6W Max	Bulk Pack 100
5750000001	Cap: Fits all holders 570, 571 and 576 series	Bulk Pack 100

Additional Information



Datasheet 570 Series



Datasheet 571 Series



Datasheet 576 Series



Resources 570 Series



Resources 571 Series



Resources 576 Series



Samples 570 Series



Samples 571 Series



Samples 576 Series

Disclaimer Notice - Information furnished is believed to be accurate and reliable. However, users should independently evaluate the suitability of and test each product selected for their own applications. Littelfuse products are not designed for, and may not be used in, all applications. Read complete Disclaimer Notice at: www.littelfuse.com/disclaimer-electronics.

Looking for pricing, stock, or lifecycle information?

Click below to explore more details on WIN SOURCE:

 [View 5710000001 on WIN SOURCE](#)

 [Littelfuse Inc. Information](#)

Optimize Your Supply Chain with WIN SOURCE Solutions

-  Global Sourcing Solution
-  Obsolete Management
-  Cost Control Management
-  Shortage Management
-  Alternative Solution
-  Excess Inventory Management