



**THE DATASHEET OF
WP26DK-P034VA3-R15000**



WP26DK-P034VA3-R15000

Product Details

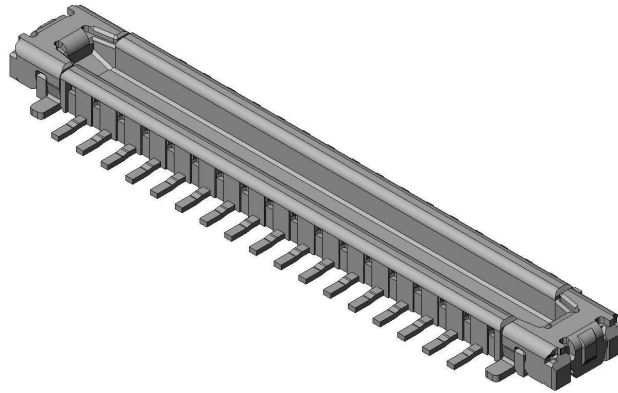

Features

Board-to-Board (FPC) Connector, 34 pos., 0.35mm pitch, 0.6mm stacking height, SMT, with power terminals, Plug

Part Number	WP26DK-P034VA3-R15000
Status	Active
Number of Positions	34 pos. (Signal terminal, +2 Power terminals)
Contact Pitch	0.35 mm
Rated Current (AC, DC per pos.)	Signal: 0.3 A, Power Supply: 3.0 A
Rated Voltage (AC, DC)	50 V
Applications	Mobile phones, smartphones, wearable devices, tablet PCs, notebook PCs, digital cameras, VR/AR headsets and other small portable devices
Connector Type	Plug
Connector Style	Straight
Number of Rows	2 rows
PCB Mounting Method	Soldering (SMT)

Material of Contact	Copper alloy
Finish of Contact in Connecting Area	Gold plating
Finish of Contact in PCB Mounting Area	Gold plating
Material of Insulator	Heat-resistant plastic
PCB Mounted Height	0.49 mm
PCB Boardlock Feature	Hold-down (double as power contact)
Body Length	7.75 mm
Body Breadth	1.81 mm
Total Insertion Force	57 N max.
Total Extraction Force	5.1 N min.
Operating Temperature Range	-40 Deg. C to +85 Deg. C
Mating Cycles	30 times
Packaging Type	Embossed tape packaging
Quantity in The Standard Packaging	15,000 pieces/reel
RoHS compliant	10 substances (2011/65/EU, (EU)2015/863)
REACH compliant	233 substances (17/01/2023)
Combination	WP26DK-S034VA3-R15000
Remarks	

Notice

1. The values specified in this web site are only for reference. The products and their specifications are subject to change without notice. Contact our sales staff for further information before considering or

ordering any of our products.

For purchase, a product specification must be agreed upon.

2. Users are requested to provide protection circuits and redundancy circuits to ensure safety of the equipment, and sufficiently review the suitability of JAE's products to the equipment.
3. The products presented in this web site are designed for the uses recommended below.

We strongly suggest you contact our sales staff when considering use of any of the products in any other way than the recommended applications or for a specific use that requires an extremely high reliability.

(1) Applications that require consultation:

*Please contact us if you are considering use involving a quality assurance program that you specify or that is peculiar to the industry, such as:

Automotive electrical components, train control, telecommunications devices (mainline), traffic light control, electric power, combustion control, fire prevention or security systems, disaster evention equipment, etc.

*We may separately give you our support with a quality assurance program that

you specify, when you think of a use such as :

Aviation or space equipment, submarine repeaters, nuclear power control systems, medical equipment for life support, etc.

(2) Recommended applications include:

*Computers, office appliances, telecommunications devices (terminals, mobile units), measuring equipment, audiovisual equipment, home electric appliances, factory automation equipment, etc

Mouser Electronics

Authorized Distributor

Click to View Pricing, Inventory, Delivery & Lifecycle Information:

[JAE Electronics:](#)

[WP26DK-P034VA3-R15000](#)

Looking for pricing, stock, or lifecycle information?

Click below to explore more details on WIN SOURCE:

- ⊖ [View WP26DK-P034VA3-R15000 on WIN SOURCE](#)
- ⊖ [JAE Electronics Information](#)

Optimize Your Supply Chain with WIN SOURCE Solutions

- ✓ Global Sourcing Solution
- ✓ Obsolete Management
- ✓ Cost Control Management
- ✓ Shortage Management
- ✓ Alternative Solution
- ✓ Excess Inventory Management