



**THE DATASHEET OF  
ABM8AIG-24.000MHZ-12-2Z-T3**





ABM8AIG



3.2 x 2.5 x 0.8 mm  
**RoHS/RoHS II Compliant**  
 MSL = N/A: Not Applicable

## Features

- AEC-Q200 Qualified
- Automotive Grade 1: -40°C to +125°C
- Automotive Grade 0: -40°C to +150°C (Available Upon Request)
- TS16949 Production Line Certified
- PPAP Available Upon Request
- Hermetically Seam-sealed Ceramic Package
- RoHS/RoHS II Compliant and Pb free

## Applications

- Infotainment Systems
- Keyless Entry & Startup
- GPS & Navigation
- Comfort control
- ADAS (Advanced Driver Assistance Systems)
- Vehicle to Vehicle Communication
- LiDAR (Light Detection and Ranging)
- In-vehicle Networking
- Powertrain & Drive Control
- Power Control & Conversion
- Industrial Control & Automation

## Electrical Specifications

Parameters	Min.	Typ.	Max.	Units	Notes
Frequency Range	8.000		54.000	MHz	
Operation Mode	Fundamental				
Operating Temperature <sup>[Note 1]</sup>	-40		+125	°C	Option "blank"; See options
	-40		+150		Option "V"; See options
Storage Temperature <sup>[Note 1]</sup>	-40		+125	°C	Option "blank, J, D, N"
	-40		+150		Option "V"
Frequency Tolerance @ +25°C	-50		+50	ppm	Option "blank"; See options
Frequency Stability over the Operating Temperature ( ref. to +25°C)	-100		+100	ppm	Option "blank"; See options
	-150		+150		Option "R"; See options
Equivalent series resistance (R1)			500	Ω	8.000 – 9.999 MHz
			100		10.000 – 15.999 MHz
			70		16.000 – 19.999 MHz
			50		20.000 – 25.999 MHz
			40		26.000 – 39.999 MHz
			35		40.000 – 54.000 MHz
Shunt capacitance (C0)			2.0	pF	
Load capacitance (CL)	18			pF	Option "blank"; See options
Drive Level		10	100	μW	
Aging	-2		+2	ppm	@25°C± 3°C First year
Insulation Resistance	500			MΩ	@100 Vdc ± 15V

Note 1: Operating temperature range option -40°C to +150°C only available in select frequencies and electrical performance options. Please contact Abracon for availability.



ABM8AIG



3.2 x 2.5 x 0.8 mm  
**RoHS/RoHS II Compliant**  
 MSL = N/A: Not Applicable

## Options and Part Identification (left blank if standard)

ABM8AIG-  MHz -  -  -    -

**Frequency in MHz**  
 Please specify the frequency in MHz. (e.g. 14.31818MHz)

**Load Capacitance (pF)**  
 Blank: 18pF  
 If not standard, please specify CL in pF or S for series

**Custom ESR if other than standard**  
 R □: Specify a value in Ω (e.g.: R80)

**Packaging**  
 Blank: Bulk  
 T: 1k pcs / reel  
 T3: 3k pcs / reel

**Operating Temp.**  
 Blank: -40°C to +125°C  
 N: -30°C to +85°C  
 D: -40°C to +85°C  
 J: -40°C to +105°C  
 V: -40°C to +150°C (\*)

(\*) Contact Abracon for Availability

**Freq. Tolerance**  
 Blank: ± 50 ppm  
 4: ± 30 ppm  
 3: ± 25 ppm  
 2: ± 20 ppm  
 7: ± 15 ppm  
 1: ± 10 ppm

**Freq. Stability**  
 Blank: ± 100 ppm  
 R: ± 150 ppm  
 Z: ± 50 ppm  
 P: ± 45 ppm (\*)  
 F: ± 40 ppm (\*)  
 H: ± 35 ppm (\*)  
 Y: ± 30 ppm (\*)  
 W: ± 25 ppm (\*)  
 X: ± 20 ppm (\*)  
 G: ± 15 ppm (\*)

(\*) Contact Abracon for Availability



ABM8AIG



3.2 x 2.5 x 0.8 mm  
 RoHS/RoHS II Compliant  
 MSL = N/A: Not Applicable

## Mechanical Dimensions

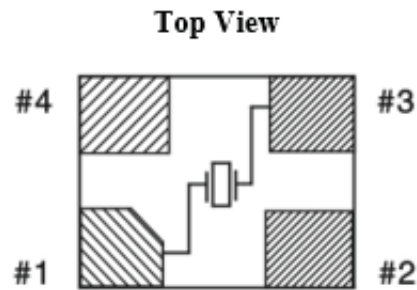
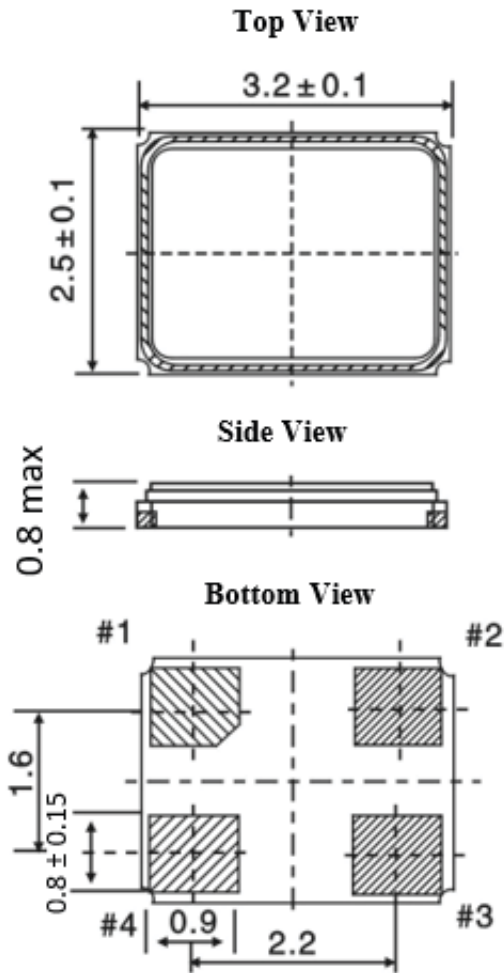

Pin #1: Crystal  
 Pin #3: Crystal

Pin #2: GND (\*)  
 Pin #4: GND (\*)

(\*) Electrically connected to lid

## Recommended Land Pattern

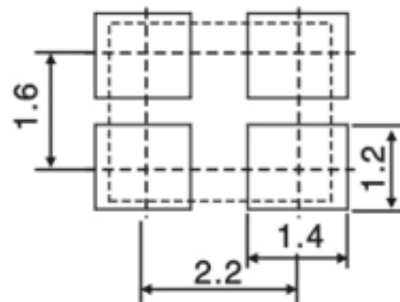

**Note:** Due to availability of raw materials, this part may be manufactured with the chamfer on pin 1 or pin 4. Be advised that this does not affect the electrical characteristics of the crystal in any way.

Dimensions: mm



ABM8AIG



3.2 x 2.5 x 0.8 mm  
 RoHS/RoHS II Compliant  
 MSL = N/A: Not Applicable

## Reflow Profile

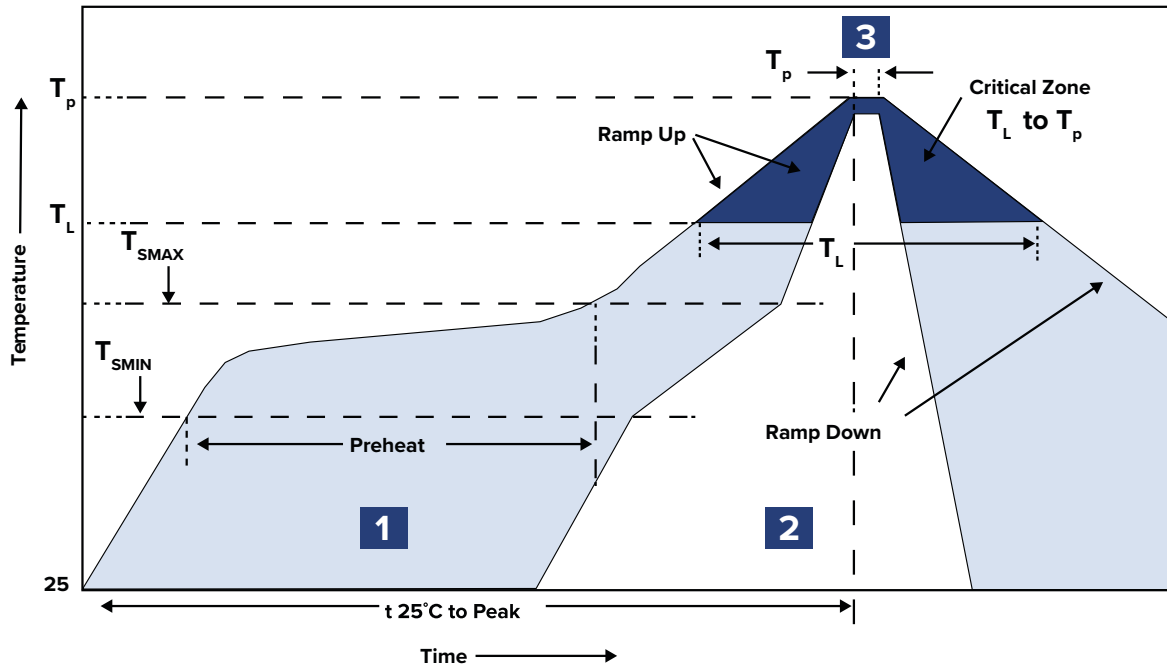

Zone	Description	Temperature	Time
1	Preheat / Soak	$T_{SMIN} \sim T_{SMAX}$ 150°C ~ 180°C	60 ~ 120 sec.
2	Reflow	$T_L$ 230°C	30 ~ 40 sec.
3	Peak heat	$T_P$ 260°C ± 5°C	10 sec. MAX



ABM8AIG



3.2 x 2.5 x 0.8 mm  
 RoHS/RoHS II Compliant  
 MSL = N/A: Not Applicable

## Packaging

Tape and Reel:  
 T: 1,000pcs/reel  
 T3: 3,000pcs/reel

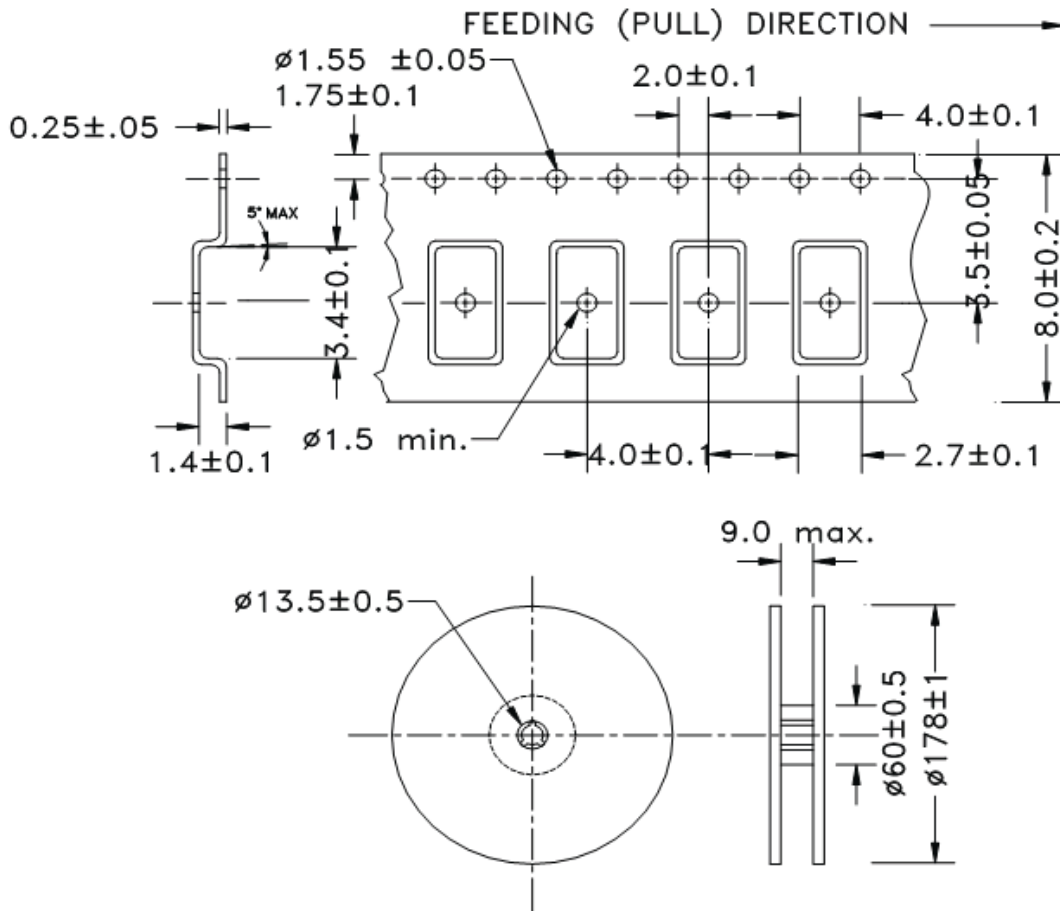

Dimensions: mm

**ATTENTION:** Abracon LLC's products are COTS – Commercial-Off-The-Shelf products; suitable for Commercial, Industrial and, where designated, Automotive Applications. Abracon's products are not specifically designed for Military, Aviation, Aerospace, Life-dependent Medical applications or any application requiring high reliability where component failure could result in loss of life and/or property. For applications requiring high reliability and/or presenting an extreme operating environment, written consent and authorization from Abracon LLC is required. Please contact Abracon LLC for more information.

## Looking for pricing, stock, or lifecycle information?

Click below to explore more details on WIN SOURCE:

- ⊖ [View ABM8AIG-24.000MHZ-12-2Z-T3 on WIN SOURCE](#)
- ⊖ [Abracon LLC Information](#)

## Optimize Your Supply Chain with WIN SOURCE Solutions

- ✓ Global Sourcing Solution
- ✓ Obsolete Management
- ✓ Cost Control Management
- ✓ Shortage Management
- ✓ Alternative Solution
- ✓ Excess Inventory Management