



**THE DATASHEET OF
42364**



MR. | Adjustable handles

Technopolymer



- 1
- 2
- 3
- 4
- 5
- 6
- 7
- 8
- 9
- 10
- 11
- 12
- 13
- 14
- 15
- 16
- 17
- 18

LEVER BODY

Glass-fibre reinforced polyamide based (PA) technopolymer, black, orange, grey colours, matte finish.

STANDARD EXECUTIONS

Glass-fibre reinforced technopolymer clamping element, black colour, with knurling on the protruding part to make initial tightening easier.

- **MR-A:** black-oxide steel boss, plain or threaded blind hole. Black-oxide steel retaining screw, AISI 302 stainless steel return spring.
- **MR-B:** brass boss, threaded blind hole. Brass retaining screw, AISI 302 stainless steel return spring.
- **MR-p:** black-oxide steel threaded stud, chamfered flat end UNI 947 : ISO 4753 (see Technical data on page A-10). Black-oxide steel retaining screw, AISI 302 stainless steel return spring.

STRESS RESISTANCE

See ERX. page 324.

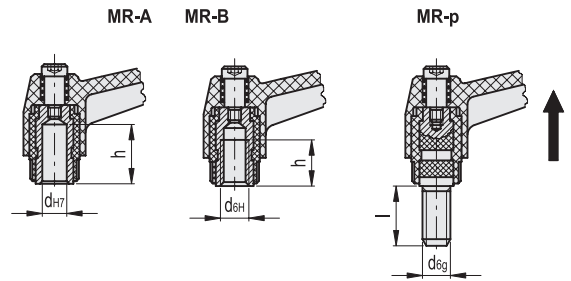
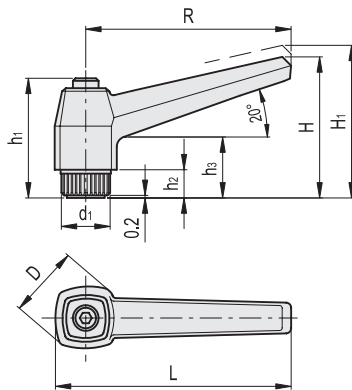

Conversion Table	
1 mm = 0,039 inch	
R	
mm	inch
42	1.65
63	2.48
80	3.15
100	3.94

* Complete with colour index of the lever body, example: (C9, C2, C31)

- C9**
RAL9005
- C2**
RAL2004
- C31**
RAL7031

MR-A MR-B



Code C9	Code C2	Code C31	Description	R	dH7	d6H	L	D	H	Hi	h	h1	h2	h3	d1	Teeth no.	
41101	41102	41104	MR.40 A-5-*	42	5	-	50	18	32	36.5	10	29	6	14	12	18	14
41121	41122	41124	MR.40 A-M4-*	42	-	M4	50	18	32	36.5	10	29	6	14	12	18	14
41131	41132	41134	MR.40 A-M5-*	42	-	M5	50	18	32	36.5	10	29	6	14	12	18	14
41141	41142	41144	MR.40 A-M6-*	42	-	M6	50	18	32	36.5	10	29	6	14	12	18	13
41171	41172	41174	MR.40 B-M6-*	42	-	M6	50	18	32	36.5	10	29	6	14	12	18	14
41401	41402	41404	MR.63 A-6-*	63	6	-	73	23	43	47	15	36	8	17	15	20	25
41411	41412	41414	MR.63 A-M6-*	63	-	M6	73	23	43	47	12	36	8	17	15	20	27
41421	41422	41424	MR.63 A-M8-*	63	-	M8	73	23	43	47	12	36	8	17	15	20	24
41426	41427	41429	MR.63 B-M8-*	63	-	M8	73	23	43	47	12	36	8	17	15	20	25
42001	42002	42004	MR.80 A-8-*	80	8	-	92	28	54	59.5	20	45	10	22	19	24	56
42111	42112	42114	MR.80 A-M8-*	80	-	M8	92	28	54	59.5	17	45	10	22	19	24	57
42121	42122	42124	MR.80 A-M10-*	80	-	M10	92	28	54	59.5	17	45	10	22	19	24	54
42131	42132	42134	MR.80 A-M12-*	80	-	M12	92	28	54	59.5	17	45	10	22	19	24	48
42151	42152	42154	MR.80 B-M10-*	80	-	M10	92	28	54	59.5	17	45	10	22	19	24	56
42401	42402	42404	MR.100 A-10-*	100	10	-	114	33	65	70.5	25	53	12	25	25	28	114
42501	42502	42504	MR.100 A-M10-*	100	-	M10	114	33	65	70.5	20	53	12	25	25	28	114
42511	42512	42514	MR.100 A-M12-*	100	-	M12	114	33	65	70.5	20	53	12	25	25	28	112
42521	42522	42524	MR.100 A-M14-*	100	-	M14	114	33	65	70.5	20	53	12	25	25	28	104
42531	42532	42534	MR.100 A-M16-*	100	-	M16	114	33	65	70.5	20	53	12	25	25	28	95

Clamping levers

* Complete with colour index of the lever body, example: (C9, C2, C31)

C9
 RAL9005

C2
 RAL2004

C31
 RAL7031



MR-p

METRIC





Code C9	Code C2	Code C31	Description	R	d6g	L	D	H	H1	h1	h2	h3	d1	l	Teeth no.		
41201	41202	41204	MR.40 p-M5x10-*	42	M5	50	18	32	36.5	29	6	14	12	10	18	15	
41211	41212	41214	MR.40 p-M5x16-*	42	M5	50	18	32	36.5	29	6	14	12	16	18	16	
41221	41222	41224	MR.40 p-M5x20-*	42	M5	50	18	32	36.5	29	6	14	12	20	18	17	
41301	41302	41304	MR.40 p-M6x10-*	42	M6	50	18	32	36.5	29	6	14	12	10	18	16	
41311	41312	41314	MR.40 p-M6x16-*	42	M6	50	18	32	36.5	29	6	14	12	16	18	17	
41321	41322	41324	MR.40 p-M6x20-*	42	M6	50	18	32	36.5	29	6	14	12	20	18	18	
41331	41332	41334	MR.40 p-M6x25-*	42	M6	50	18	32	36.5	29	6	14	12	25	18	19	
41335	41336	41338	MR.40 p-M6x30-*	42	M6	50	18	32	36.5	29	6	14	12	30	18	20	
41341	41342	41344	MR.40 p-M6x40-*	42	M6	50	18	32	36.5	29	6	14	12	40	18	21	
41357	41358	41360	MR.40 p-M8x20-*	42	M8	50	18	32	36.5	29	6	14	12	20	18	20	
41431	41432	41434	MR.63 p-M6x10-*	63	M6	73	23	43	47	36	8	17	15	10	20	31	
41441	41442	41444	MR.63 p-M6x16-*	63	M6	73	23	43	47	36	8	17	15	16	20	32	
41451	41452	41454	MR.63 p-M6x20-*	63	M6	73	23	43	47	36	8	17	15	20	20	33	
41461	41462	41464	MR.63 p-M6x25-*	63	M6	73	23	43	47	36	8	17	15	25	20	34	
41466	41467	41469	MR.63 p-M6x30-*	63	M6	73	23	43	47	36	8	17	15	30	20	35	
41470	41475	41476	MR.63 p-M6x35-*	63	M6	73	23	43	47	36	8	17	15	35	20	35	
41471	41472	41474	MR.63 p-M6x40-*	63	M6	73	23	43	47	36	8	17	15	40	20	36	
41501	41502	41504	MR.63 p-M8x16-*	63	M8	73	23	43	47	36	8	17	15	16	20	34	
41511	41512	41514	MR.63 p-M8x20-*	63	M8	73	23	43	47	36	8	17	15	20	20	35	
41521	41522	41524	MR.63 p-M8x25-*	63	M8	73	23	43	47	36	8	17	15	25	20	37	
41531	41532	41534	MR.63 p-M8x30-*	63	M8	73	23	43	47	36	8	17	15	30	20	39	
41526	41527	41528	MR.63 p-M8x32-*	63	M8	73	23	43	47	36	8	17	15	32	20	40	
41535	41536	41538	MR.63 p-M8x35-*	63	M8	73	23	43	47	36	8	17	15	35	20	41	
41541	41542	41544	MR.63 p-M8x40-*	63	M8	73	23	43	47	36	8	17	15	40	20	43	
41551	41552	41554	MR.63 p-M8x45-*	63	M8	73	23	43	47	36	8	17	15	45	20	45	
41561	41562	41564	MR.63 p-M8x50-*	63	M8	73	23	43	47	36	8	17	15	50	20	47	
41569	41570	41572	MR.63 p-M8x60-*	63	M8	73	23	43	47	36	8	17	15	60	20	51	
41597	41598	41600	MR.63 p-M10x40-*	63	M10	73	23	43	47	36	8	17	15	40	20	52	
42182	42183	42185	MR.80 p-M8x70-*	80	M8	92	28	54	59.5	45	10	22	19	70	24	85	
42196	42197	42198	MR.80 p-M10x16-*	80	M10	92	28	54	59.5	45	10	22	19	16	24	70	
42201	42202	42204	MR.80 p-M10x20-*	80	M10	92	28	54	59.5	45	10	22	19	20	24	72	
42211	42212	42214	MR.80 p-M10x25-*	80	M10	92	28	54	59.5	45	10	22	19	25	24	74	
42221	42222	42224	MR.80 p-M10x30-*	80	M10	92	28	54	59.5	45	10	22	19	30	24	77	
42216	42217	42218	MR.80 p-M10x32-*	80	M10	92	28	54	59.5	45	10	22	19	32	24	78	
42225	42226	42228	MR.80 p-M10x35-*	80	M10	92	28	54	59.5	45	10	22	19	35	24	80	
42231	42232	42234	MR.80 p-M10x40-*	80	M10	92	28	54	59.5	45	10	22	19	40	24	82	
42241	42242	42244	MR.80 p-M10x50-*	80	M10	92	28	54	59.5	45	10	22	19	50	24	87	
42245	42246	42248	MR.80 p-M10x60-*	80	M10	92	28	54	59.5	45	10	22	19	60	24	92	
42251	42252	42254	MR.80 p-M12x70-*	80	M10	92	28	54	59.5	45	10	22	19	70	24	97	
42301	42302	42304	MR.80 p-M12x20-*	80	M12	92	28	54	59.5	45	10	22	19	20	24	76	
42311	42312	42314	MR.80 p-M12x25-*	80	M12	92	28	54	59.5	45	10	22	19	25	24	80	
42321	42322	42324	MR.80 p-M12x30-*	80	M12	92	28	54	59.5	45	10	22	19	30	24	84	
42325	42326	42328	MR.80 p-M12x35-*	80	M12	92	28	54	59.5	45	10	22	19	35	24	88	
42331	42332	42334	MR.80 p-M12x40-*	80	M12	92	28	54	59.5	45	10	22	19	40	24	92	
42335	42336	42338	MR.80 p-M12x45-*	80	M12	92	28	54	59.5	45	10	22	19	45	24	92	
42341	42342	42344	MR.80 p-M12x50-*	80	M12	92	28	54	59.5	45	10	22	19	50	24	100	
42351	42352	42354	MR.80 p-M12x60-*	80	M12	92	28	54	59.5	45	10	22	19	60	24	108	
42361	42362	42364	MR.80 p-M12x70-*	80	M12	92	28	54	59.5	45	10	22	19	70	24	116	
42365	42366	42368	MR.80 p-M12x80-*	80	M12	92	28	54	59.5	45	10	22	19	80	24	118	
42381	42382	42384	MR.80 p-M14x40-*	80	M14	92	28	54	59.5	45	10	22	19	40	24	153	
42601	42602	42604	MR.100 p-M12x30-*	100	M12	114	33	65	70.5	53	12	25	25	30	28	138	
42651	42652	42654	MR.100 p-M12x50-*	100	M12	114	33	65	70.5	53	12	25	25	50	28	150	
42701	42702	42704	MR.100 p-M12x70-*	100	M12	114	33	65	70.5	53	12	25	25	70	28	162	
42801	42802	42804	MR.100 p-M14x30-*	100	M14	114	33	65	70.5	53	12	25	25	30	28	142	
42805	42806	42808	MR.100 p-M14x35-*	100	M14	114	33	65	70.5	53	12	25	25	35	28	147	
42831	42832	42834	MR.100 p-M14x50-*	100	M14	114	33	65	70.5	53	12	25	25	50	28	162	
42851	42852	42854	MR.100 p-M14x70-*	100	M14	114	33	65	70.5	53	12	25	25	70	28	182	
42901	42902	42904	MR.100 p-M16x30-*	100	M16	114	33	65	70.5	53	12	25	25	30	28	149	
42951	42952	42954	MR.100 p-M16x50-*	100	M16	114	33	65	70.5	53	12	25	25	50	28	177	
42981	42982	42984	MR.100 p-M16x70-*	100	M16	114	33	65	70.5	53	12	25	25	70	28	205	

Looking for pricing, stock, or lifecycle information?

Click below to explore more details on WIN SOURCE:

-  [View 42364 on WIN SOURCE](#)
-  [Elesa USA Corporation Information](#)

Optimize Your Supply Chain with WIN SOURCE Solutions

-  Global Sourcing Solution
-  Obsolete Management
-  Cost Control Management
-  Shortage Management
-  Alternative Solution
-  Excess Inventory Management