



THE DATASHEET OF
61301421021



1

2

3

4

5

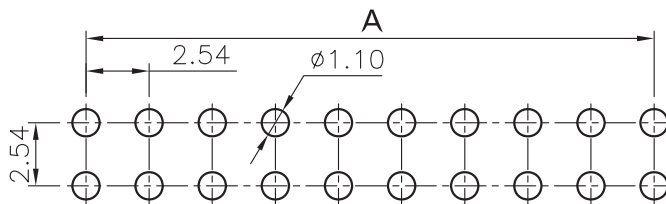

PCB LAYOUT - COMPONENT VIEW

TECHNICAL CHARACTERISTICS

MATERIAL
 INSULATOR: PA6T
 FLAMMABILITY RATING: UL94-V0
 COLOR: BLACK
 CONTACT MATERIAL: COPPER ALLOY
 CONTACT TYPE: STAMPED
 CONTACT PLATING: GOLD
 QUALITY CLASS: 3 AS PER CECC 75 301-802
 PITCH: 2.54MM

ENVIRONMENTAL
 OPERATING TEMPERATURE: -40 UP TO 105°C
 COMPLIANCE: LEAD FREE AND ROHS

ELECTRICAL
 CURRENT RATING: 3A
 WORKING VOLTAGE: 250V AC
 INSULATOR RESISTANCE: >1000 MOHM
 DIELECTRIC WITHSTANDING VOLTAGE: 500V AC/MN
 CONTACT RESISTANCE: 20 mOHM MAX

STANDARD
 CERTIFIED: E323964

SOLDERING
 JEDEC LEAD FREE WAVE SOLDERING PROCESS

PACKAGING
 BAG

DIMENSION
 A = 2.54 x (NB PINS/2 -1)
 B = 2.54 x (NB PINS/2)

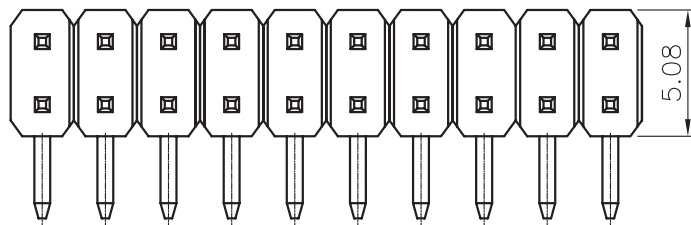
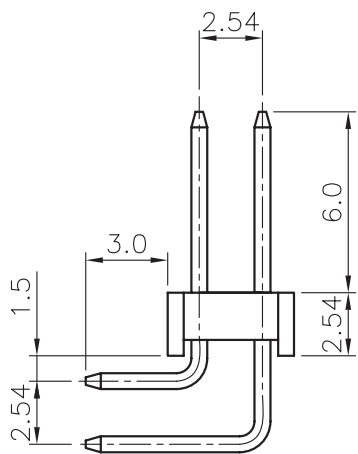
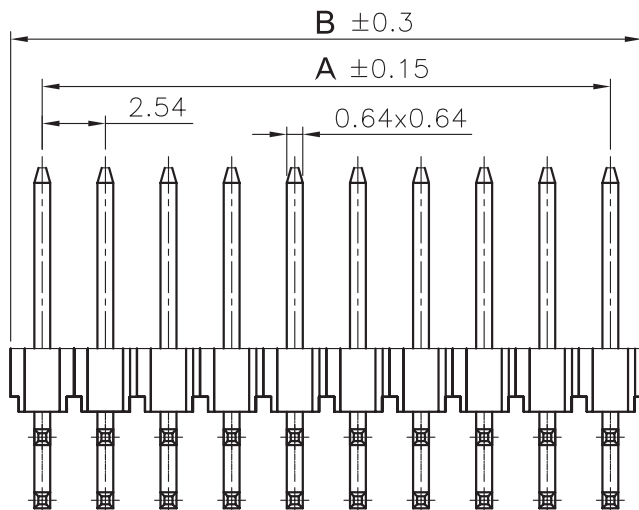

RoHS Compliant

PROJECTION:



GENERAL TOLERANCE

.X = +/- 0.2
 .XX = +/- 0.15



APPROVAL: GMo

UNIT: MM

SCALE:

SHEET: 1/3

DRAW: PEARL

DESCRIPTION: 2.54MM ANGLED DUAL PIN HEADER

WERI PART NO: 613 0xx 210 21

SIZE

A4

REV	DATE	FILE	BY
H	08-APR-13	DIMENSION	AR
I	16-JUN-15	PCN PA6T	AK
J	08-JUL-15	PACKAGING	AK
K	18-JUL-16	TPK	AK

1

2

3

4

5

A

B

C

D

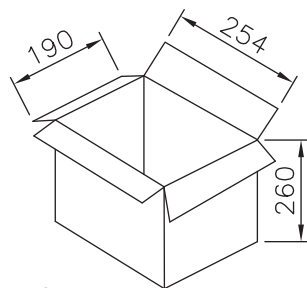
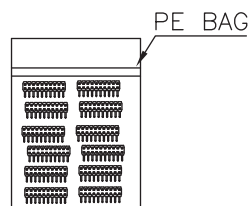

Inner Carton

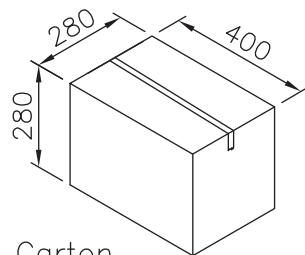

Carton

Pin	Pcs / Bag	Pcs / Inner Carton	Pcs / Carton	Pin	Pcs / Bag	Pcs / Inner Carton	Pcs / Carton
4	1000	18000	36000	28	250	2500	5000
6	1000	12000	24000	30	250	2250	4500
8	1000	9000	18000	32	250	2250	4500
10	1000	8000	16000	34	250	1750	3500
12	1000	6000	12000	36	250	1750	3500
14	1000	5000	10000	40	200	1600	3200
16	500	4000	8000	44	200	1600	3200
18	500	4000	8000	60	100	1600	3200
20	500	3500	7000	64	100	1600	3200
22	500	2500	5000	72	100	1600	3200
24	250	2500	5000	80	100	1600	3200
26	250	2500	5000				

RoHS Compliant

G

F

E

D

C

B

A

PROJECTION:

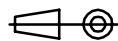

GENERAL TOLERANCE

.X = \pm 0.2.XX = \pm 0.15

APPROVAL: GMo

UNIT: MM

SCALE:

SHEET: 2/3

DRAW: PEARL

DESCRIPTION: 2.54MM ANGLED DUAL PIN HEADER

WERI PART NO: 613 0xx 210 21

SIZE

A4

REV

DATE

FILE

BY

1

2

3

4

5

Cautions and Warnings:

This electronic component is designed and developed with the intention for use in general electronics equipments.

Before incorporating the components into any equipments in the field such as aerospace, aviation, nuclear control, submarine, transportation, (automotive control, train control, ship control), transportation signal, disaster prevention, medical, public information network etc. where higher safety and reliability are especially required or if there is possibility of direct damage or injury to human body, Würth Elektronik must be asked for a written approval.



In addition, even electronic component in general electronic equipments, when used in electrical circuits that require high safety, reliability functions or performance, the sufficient reliability evaluation-check for the safety must be performed before by the user before usage.

A

B

C

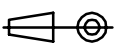
RoHS Compliant

G				PROJECTION: 	GENERAL TOLERANCE .X = +/- 0.2 .XX = +/- 0.15		
F							
E							
D							
C				APPROVAL: JC	UNIT: MM	DESCRIPTION: DISCLAIMER	SIZE A4
B					SCALE:		
A	10-SEP-14	PDF	QL		SHEET: 3/3	WERI PART NO: DISCLAIMER	
REV	DATE	FILE	BY		DRAW: QL		

D

Looking for pricing, stock, or lifecycle information?

Click below to explore more details on WIN SOURCE:

 [View 61301421021 on WIN SOURCE](#)

 [Wurth Electronics Inc Information](#)

Optimize Your Supply Chain with WIN SOURCE Solutions

-  Global Sourcing Solution
-  Obsolete Management
-  Cost Control Management
-  Shortage Management
-  Alternative Solution
-  Excess Inventory Management