

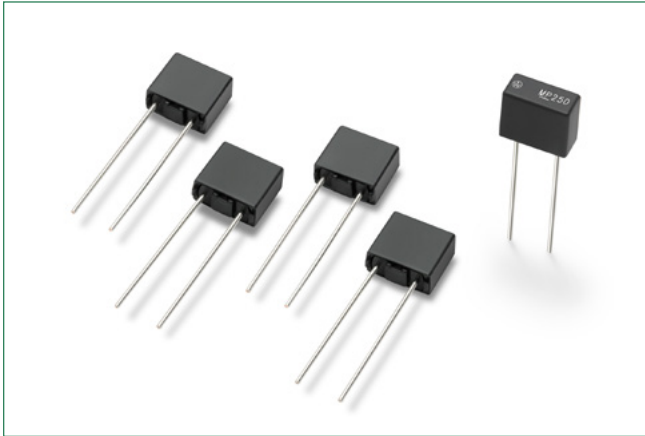

THE DATASHEET OF
39812000000



398 Series, TE5® Modul Protector® Fuse



Description

The 398 Series TE5® Fuses are short circuit protectors, medium Time-Lag type, and 65V rated.

Features

- Reduced PCB space requirements
- Highly defined cut-off times
- Low internal resistance
- Flame resistant encapsulated casing
- Available from 0.125A to 4A
- Halogen free, Lead-free and RoHS compliant

Agency Approvals

Agency	Agency File Number	Ampere Range
	E67006	0.125A - 4A

Applications

- Microprocessor protection

Additional Information



Datasheet



Resources



Samples

Electrical Characteristics

% of Ampere Rating	Opening Time
300	10 Seconds, Max.

Electrical Characteristics

Amp Code	Rated Current	Marking Code*	Voltage Rating	Breaking Capacity	Nominal Cold Resistance (Ohms)	Cold Resistance $0.1 \times I_N$ typ. (mΩ)	Power Dissipation $1.0 \times I_N$ max. (mW)	Melting Integral $10 \times I_N$ max. (A ² s)	Agency Approvals 
0125	125mA	MP13	65V	50A@65 VAC/DC	0.9610	900	50	0.036	x
0250	250mA	MP25	65V		0.3540	355	50	0.063	x
0315	315mA	MP32	65V		0.2600	261	60	0.08	x
0400	400mA	MP40	65V		0.1860	186	75	0.18	x
0500	500mA	MP50	65V		0.1540	155	90	0.33	x
0630	630mA	MP63	65V		0.1150	115	120	0.48	x
0800	800mA	MP80	65V		0.0850	85	140	1.02	x
1100	1.00A	MP100	65V		0.0640	65	170	1.10	x
1125	1.25A	MP125	65V		0.0480	48	210	2.34	x
1160	1.60A	MP160	65V		0.0340	34	320	4.66	x
1200	2.00A	MP200	65V		0.0260	26	425	8.40	x
1250	2.50A	MP250	65V		0.0210	21	550	14.81	x
1315	3.15A	MP315	65V		0.0155	16	650	29.27	x
1400	4.00A	MP400	65V		0.0120	12	1000	41.12	x

Notes:

1. 1.00 means the number one with two decimal places, 1,000 means the number one thousand.
2. Resistance is measured at 10% of rated current, 25°C.

* Physical Marking on top of the device

Temperature Re-rating Curve

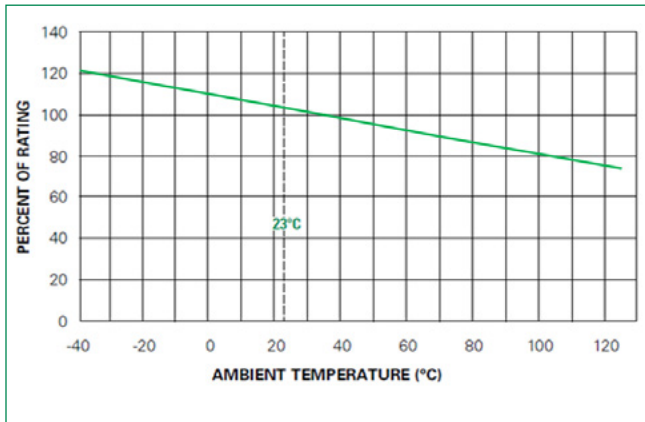

Note:
1. Derating depicted in this curve is in addition to the standard derating of 25% for continuous operation.

Average Time Current Curves

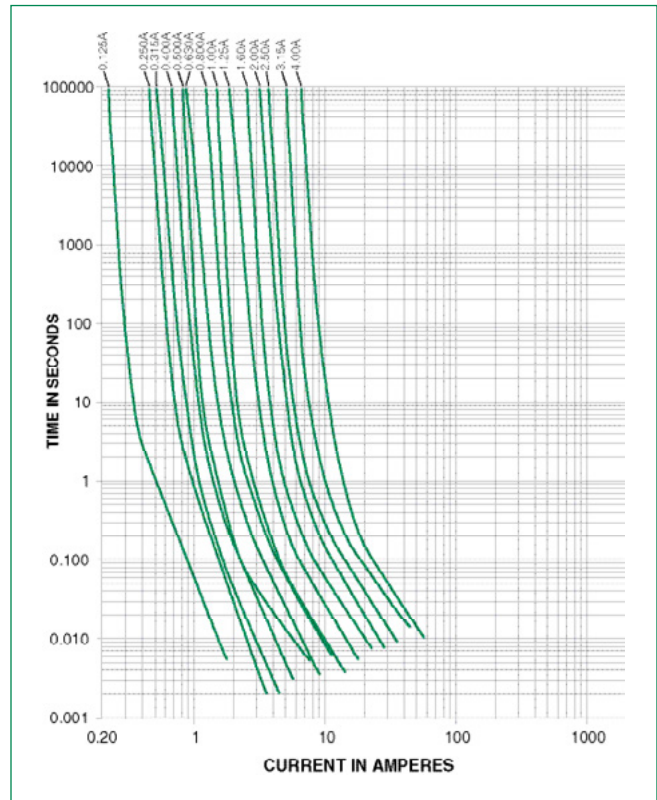

Soldering Parameters - Wave Soldering

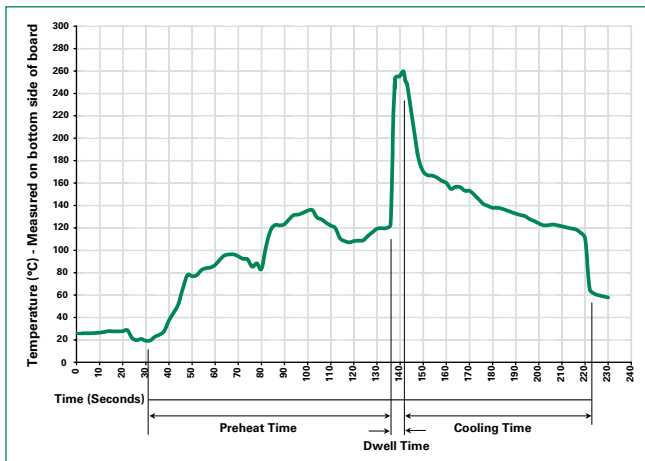

Recommended Process Parameters:

Wave Parameter	Lead-Free Recommendation
Preheat: (Depends on Flux Activation Temperature)	(Typical Industry Recommendation)
Temperature Minimum:	100°C
Temperature Maximum:	150°C
Preheat Time:	60-180 seconds
Solder Pot Temperature:	260°C Maximum
Solder Dwell Time:	2-5 seconds

Recommended Hand-Solder Parameters:

Solder Iron Temperature: 350°C +/- 5°C
Heating Time: 5 seconds max.

Note: These devices are not recommended for IR or Convection Reflow process.

Product Characteristics

Materials	Base/Cap: Thermoplastic Polyamide PA 6.6, UL 94V-0 Round Pins: Copper, Tin-plated
Lead Pull Strength	10N (EN 60068-2-21)
Solderability	260°C, ≤ 3s. (Wave) 350°C, ≤ 1s. (Soldering Iron)
Soldering Heat Resistance	260°C, 10s. (IEC 60068-2-20) 350°C, 3s. (Soldering Iron)

Operating Temperature	-40°C to +125°C (Consider re-rating)
Climatic Category	-40°C to +85°C/21 days (IEC 60068-1,-2-1,-2-2,-78)
Stock Conditions	+10°C to +60°C RH, ≤ 75% yearly average, without dew, maximum value for 30 days-95%
Vibration Resistance	24 cycles at 15 min. each (IEC 60068-6) 10 - 60Hz at 0.75mm amplitude 60 - 2000Hz at 10g acceleration

Dimensions

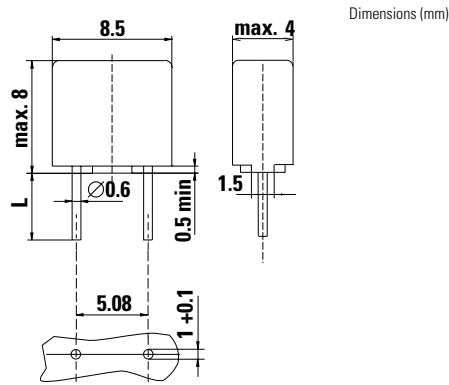

Part Numbering System



Packaging

Packaging Option	Packaging Specification	Quantity	Quantity & Packaging Code	Reel Size
398 Series				
Tape & Amp pack	N/A	1,400	0000	N/A

Looking for pricing, stock, or lifecycle information?

Click below to explore more details on WIN SOURCE:

 [View 39812000000 on WIN SOURCE](#)

 [Littelfuse Inc. Information](#)

Optimize Your Supply Chain with WIN SOURCE Solutions

-  Global Sourcing Solution
-  Obsolete Management
-  Cost Control Management
-  Shortage Management
-  Alternative Solution
-  Excess Inventory Management