



**THE DATASHEET OF
M55-7022042R**



HARWIN

CONNECT TECHNOLOGY
WITH CONFIDENCE

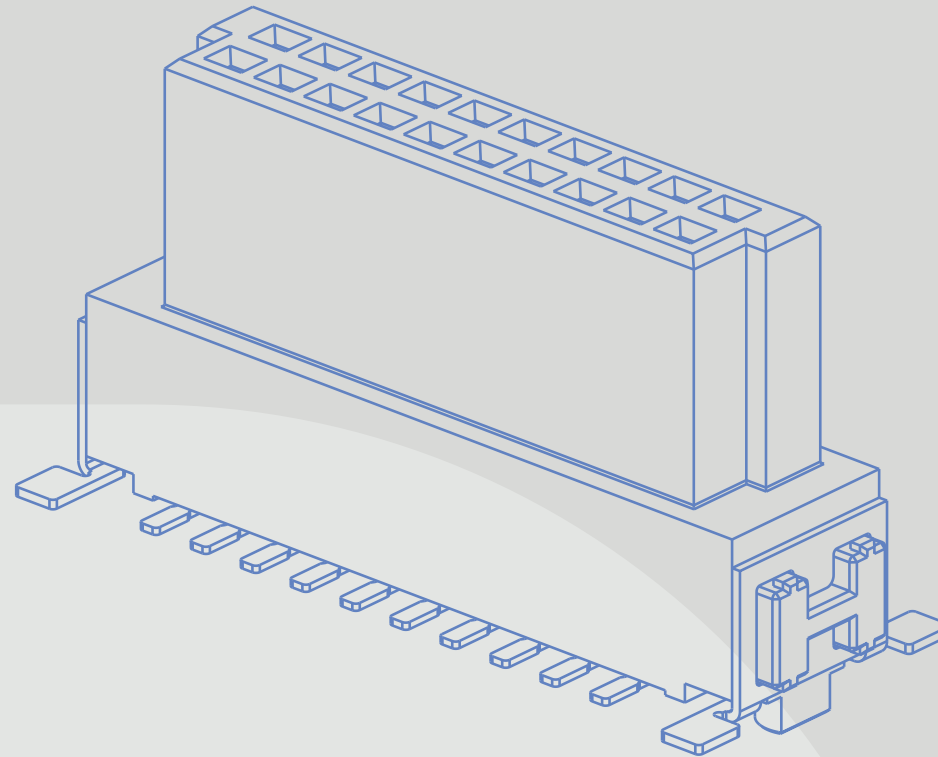

KONTROL INDUSTRIAL CONNECTORS

DURABLE HIGH PERFORMANCE 1.27MM (.05") PITCH

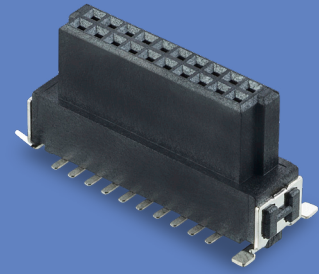

DEPENDABLE
CONNECTIVITY
ACROSS THE BOARD

BBi
RANGE

HARWIN

KONTROL

BBi CONNECTORS FROM HARWIN.

Durability and High Performance on 1.27mm (.05") Pitch

Capable industrial-grade connection with complete flexibility. Reliable and space-saving connections, polarized and protected for automated manufacturing and fault-free assembly.

Kontrol is designed to withstand the demands of industrial applications with a fully flexible connection. The board-to-board mating performs from fully mated to 1.5mm separation, giving a full range of mating heights from 8mm to 20mm parallel board separation.

With horizontal PCB connectors and IDC cable connectors, Kontrol can be used for edge-to-edge, motherboard-to-daughterboard and cable-to board. Mated connectors can carry a data rate up to 3Gb/s.

Gull-wing SMT terminations allow easy solder inspection, and additional SMT hold-downs increase the board peel strength.

12 to 80 contacts in a double-row layout. Polarized housings assist with error-free assembly, fully shrouded when mated to protect against accidental damage. Suitable for blind mating connection.

Packaged in tape and reel (with additional pick and place where required) for full assembly automation.

FEATURES

- Robust and fully shrouded, withstands lateral and twisting forces on mating
- Polarized housings for error-free assembly
- Supplied in tape & reel for high volume surface mount assembly

APPLICATIONS

- Embedded computing
- Factory automation
- Battery management
- Handheld monitoring



KONTROL

SPECIFICATIONS

MATERIALS	ELECTRICAL	MECHANICAL	ENVIRONMENTAL
Housings: High Temperature LCP, UL94V-0	Current per contact: 1.2A max (PCB) 0.5A max (cable)	Durability: 500 operations	Operating temperature: -55°C to +125°C (PCB) -20°C to +105°C (cable)
Contacts: Phosphor Bronze	Working voltage: 100V AC	Insertion force (per contact): 0.8N max	Vibration resistance: 20G (196m/s²) for 12 hrs
Contact Finish: Gold on contact area, Tin on termination	Maximum voltage: 500V AC	Withdrawal force (per contact): 0.2N min	Humidity: 90-95% RH for 96 hours
SMT Retention Tabs: Brass, Tin finish	Data rate: Up to 3Gb/s	Pitch: 1.27mm (.05")	Compliance: RoHS Compliant REACH / CMRT statements
Cable: PVC to UL2678, 30AWG	Insulation resistance: 1GΩ min	Board-to-Board height (vertical): 8mm to 20mm	

Specifications are subject to change.



KONTROL

PRODUCT CATEGORIES

Vertical SMT Connectors

Fully shrouded & polarized, SMT hold-down solder tabs and location pegs. Supplied in Tape and Reel ready for automated placement. 3 heights available for male and female connectors, with performance maintained at up to 1.5mm separation from fully mated. Total board-to-board range possible is 8mm to 20mm.

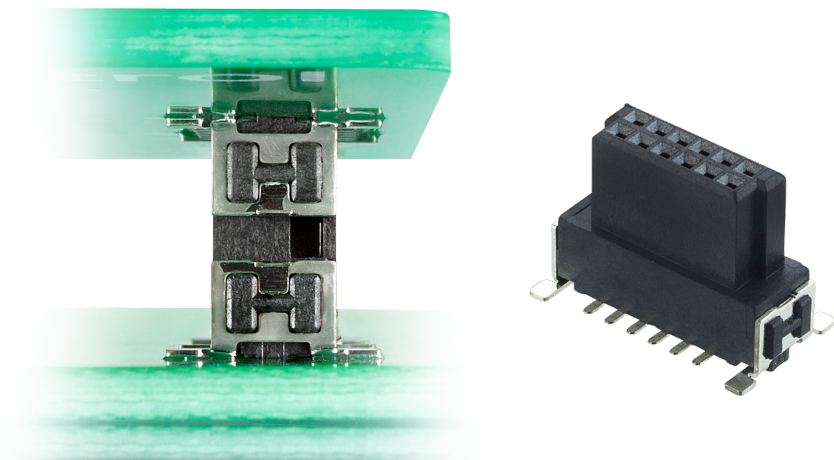

Horizontal SMT Connectors

Fully shrouded & polarized, SMT hold-down solder tabs and location pegs. Supplied in Tape and Reel ready for automated placement, no pick and place caps required. Ideal for edge-to-edge co-planar PCB mating, or use with a vertical mating connector for daughterboard connection.

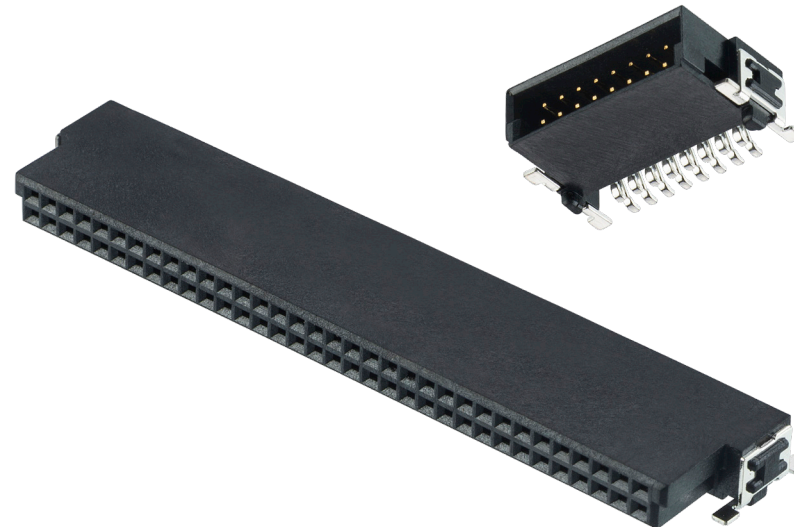

Specifications are subject to change.



VIEW FULL SERIES & SPECIFICATIONS [HERE](#)



KONTROL

PRODUCT CATEGORIES

Female Cable Connectors

Shrouded and polarized, with added latches for strain relief and security when mated. IDC connection for easy cable assembly (tooling available). Compatible with 30AWG ribbon cable.

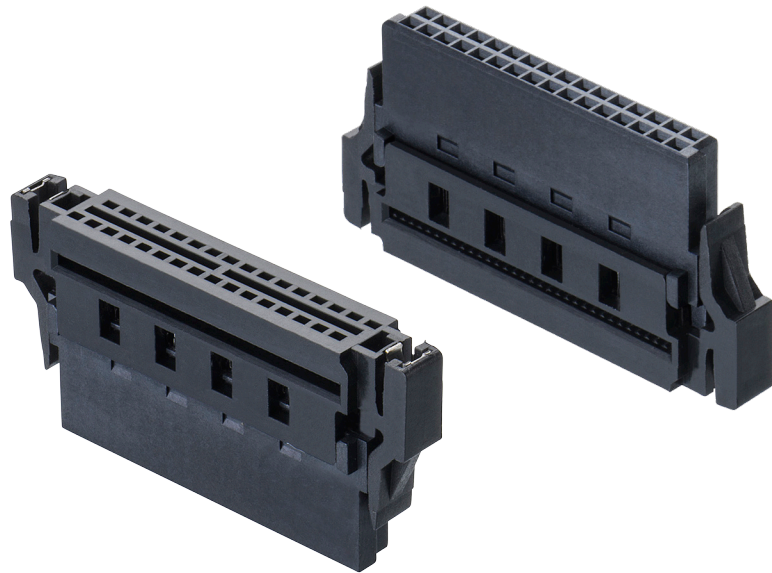

Female Cable Assemblies

Double-ended, fully assembled and available in cable lengths of 150mm or 300mm, using the female IDC cable connectors. Eliminates the additional expense of tooling and training – great for prototyping and volume production.

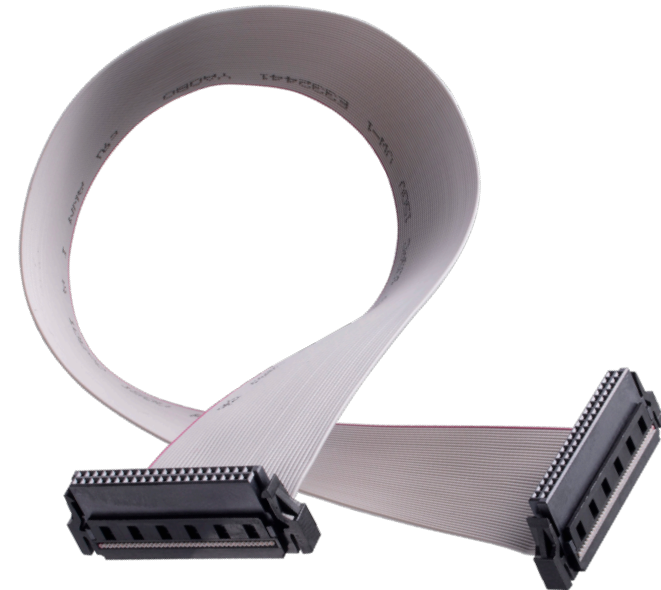

Specifications are subject to change.



VIEW FULL SERIES & SPECIFICATIONS [HERE](#)

KONTROL

DOWNLOADS

Technical Documents

Component Specification (including pin numbering system)



Product Training

Product Training Module (PTM)



Test Reports

HT060 – Kontrol General Testing



HT064 – Kontrol Comparison Testing



Specifications are subject to change.



VIEW FULL SERIES & SPECIFICATIONS [HERE](#)



HARWIN

CONNECT TECHNOLOGY
WITH CONFIDENCE



HIGH RELIABILITY
WITH SUPREME
PERFORMANCE



INNOVATIVE
DESIGNS FOR
EASY ASSEMBLY



DEPENDABLE
CONNECTIVITY
ACROSS THE BOARD

HRI
RANGE

EZI
RANGE

BBI
RANGE

FOR FURTHER INFORMATION PLEASE CONTACT:

Europe, Middle East & Africa

E: technical@harwin.com

Americas

E: technical-us@harwin.com

Asia Pacific

E: technical-asia@harwin.com

// WWW.HARWIN.COM

Looking for pricing, stock, or lifecycle information?

Click below to explore more details on WIN SOURCE:

 [View M55-7022042R on WIN SOURCE](#)

 [Harwin Inc. Information](#)

Optimize Your Supply Chain with WIN SOURCE Solutions

-  Global Sourcing Solution
-  Obsolete Management
-  Cost Control Management
-  Shortage Management
-  Alternative Solution
-  Excess Inventory Management