



**THE DATASHEET OF
DS96176CN/NOPB**



DS96176

DS96176 RS-485/RS-422 Differential Bus Transceiver



Literature Number: SNLS393A

DS96176

RS-485/RS-422 Differential Bus Transceiver

General Description

The DS96176 Differential Bus Transceiver is a monolithic integrated circuit designed for bidirectional data communication on balanced multipoint bus transmission lines. The transceiver meets EIA Standard RS-485 as well as RS-422A.

The DS96176 combines a TRI-STATE® differential line driver and a differential input line receiver, both of which operate from a single 5.0V power supply. The driver and receiver have an active Enable that can be externally connected to function as a direction control. The driver differential outputs and the receiver differential inputs are internally connected to form differential input/output (I/O) bus ports that are designed to offer minimum loading to the bus whenever the driver is disabled or when $V_{CC} = 0V$. These ports feature wide positive and negative common mode voltage ranges, making the device suitable for multipoint applications in noisy environments.

The driver is designed to handle loads up to 60 mA of sink or source current. The driver features positive and negative current-limiting and thermal shutdown for protection from line fault conditions. Thermal shutdown is designed to occur at junction temperature of approximately 160°C. The receiver features a typical input impedance of 15 k Ω , an input sensitivity of ± 200 mV, and a typical input hysteresis of 50 mV.

The DS96176 can be used in transmission line applications employing the DS96172 and the DS96174 quad differential line drivers and the DS96173 and DS96175 quad differential line receivers.

Features

- Bidirectional transceiver
- Meets EIA Standard RS-422A and RS-485
- Designed for multipoint transmission
- TRI-STATE driver and receiver enables
- Individual driver and receiver enables
- Wide positive and negative input/output bus voltage ranges
- Driver output capability ± 60 mA Maximum
- Thermal shutdown protection
- Driver positive and Negative current-limiting
- High impedance receiver input
- Receiver input sensitivity of ± 200 mV
- Receiver input hysteresis of 50 mV typical
- Operates from single 5.0V supply
- Low power requirements

Connection Diagram

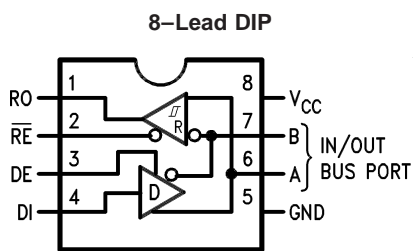

Order Number DS96176CN
See NS Package Number N08E

Receiver

Differential Inputs	Enable	Output
A-B	\overline{RE}	R
$V_{ID} \geq 0.2V$	L	H
$V_{ID} \leq -0.2V$	L	L
X	H	Z

H = High Level
L = Low Level
X = Immaterial
Z = High Impedance (off)

Function Table

Driver

Input	Enable	Outputs	
DI	DE	A	B
H	H	H	L
L	H	L	H
X	L	Z	Z

TRI-STATE® is a registered trademark of National Semiconductor Corporation.

Absolute Maximum Ratings (Note 2)

If Military/Aerospace specified devices are required, please contact the National Semiconductor Sales Office/Distributors for availability and specifications.

Storage Temperature Range	
Molded DIP	-65°C to +150°C
Lead Temperature	
Molded DIP (soldering, 10 sec.)	265°C
Maximum Power Dissipation (Note 1) at 25°C	
Molded Package	930 mW
Supply Voltage	7.0V
Differential Input Voltage	+15V/-10V
Enable Input Voltage	5.5V

Recommended Operating Conditions

	Min	Typ	Max	Units
Supply Voltage (V_{CC})	4.75	5.0	5.25	V
Voltage at Any Bus Terminal (Separately or Common Mode)	-7.0		12	V
Differential Input Voltage (V_{ID})			±12	V
Output Current HIGH (I_{OH})				
Driver			-60	mA
Receiver			-400	µA
Output Current LOW (I_{OL})				
Driver			60	mA
Receiver			16	mA
Operating Temperature (T_A)	0	25	70	°C

Note 1: Derate molded DIP package 7.5 mW/°C above 25°C.

Electrical Characteristics (Notes 3, 4)

Over recommended temperature, common mode input voltage, and supply voltage ranges, unless otherwise specified

Symbol	Parameter	Conditions	Min	Typ	Max	Units	
DRIVER SECTION							
V_{IH}	Input Voltage HIGH		2.0			V	
V_{IL}	Input Voltage LOW				0.8	V	
V_{OH}	Output Voltage HIGH	$I_{OH} = -20$ mA		3.1		V	
V_{OL}	Output Voltage LOW	$I_{OL} = 20$ mA		0.85		V	
V_{IC}	Input Clamp Voltage	$I_I = -18$ mA			-1.5	V	
$ V_{OD1} $	Differential Output Voltage	$I_O = 0$ mA			6.0	V	
$ V_{OD2} $	Differential Output Voltage	$R_L = 100\Omega$, Figure 1	2.0	2.25		V	
		$R_L = 54\Omega$, Figure 1 and Figure 2	1.5	2.0			
$\Delta V_{OD2} $	Change in Magnitude of Differential Output Voltage (Note 5)	$R_L = 54\Omega$ $V_{CM} = 0V$ Figure 1 and Figure 2			±0.2	V	
		$R_L = 100\Omega$ Figure 1					
V_{OC}	Common Mode Output Voltage (Note 6)	$R_L = 54\Omega$ or 100Ω , Figure 1			3.0	V	
$\Delta V_{OC} $	Change in Magnitude of Common Mode Output Voltage (Note 5)				±0.2	V	
I_O	Output Current (Note 5) (Includes Receiver I_I)	Output Disabled					
		$V_O = 12V$ $V_O = -7.0V$			1.0 -0.8	mA	
I_{IH}	Input Current HIGH	$V_I = 2.4V$			20	µA	
I_{IL}	Input Current LOW	$V_I = 0.4V$			-100	µA	
I_{OS}	Short Circuit Output Current (Note 10)	$V_O = -7.0V$			-250	mA	
		$V_O = 0V$			-150		
		$V_O = V_{CC}$			150		
		$V_O = 12V$			250		
I_{CC}	Supply Current	No Load	Outputs Enabled			35	mA
			Outputs Disabled			40	
RECEIVER SECTION							
V_{TH}	Differential Input High Threshold Voltage	$V_O = 2.7V$, $I_O = -0.4$ mA			0.2	V	
V_{TL}	Differential Input Low Threshold Voltage (Note 7)	$V_O = 0.5V$, $I_O = 8.0$ mA	-0.2			V	
$V_{T+} - V_{T-}$	Hysteresis (Note 8)	$V_{CM} = 0V$		50		mV	
V_{IH}	Enable Input Voltage HIGH		2.0			V	
V_{IL}	Enable Input Voltage LOW				0.8	V	
V_{IC}	Enable Input Clamp Voltage	$I_I = -18$ mA			-1.5	V	

Electrical Characteristics (Notes 3, 4) (Continued)

Over recommended temperature, common mode input voltage, and supply voltage ranges, unless otherwise specified

Symbol	Parameter	Conditions	Min	Typ	Max	Units
RECEIVER SECTION						
V_{OH}	Output Voltage HIGH	$V_{ID} = 200\text{ mV}$, $I_{OH} = -400\text{ }\mu\text{A}$, <i>Figure 3</i>	2.7			V
V_{OL}	Output Voltage LOW	$V_{ID} = -200\text{ mV}$, <i>Figure 3</i>	$I_{OL} = 8.0\text{ mA}$		0.45	V
			$I_{OL} = 16\text{ mA}$		0.50	
I_{OZ}	High Impedance State Output	$V_O = 0.45\text{V to }2.4\text{V}$			± 20	μA
I_I	Line Input Current (Note 9)	Other Input = 0V	$V_I = 12\text{V}$		1.0	mA
			$V_I = -7.0\text{V}$		0.8	
I_{IH}	Enable Input Current HIGH	$V_{IH} = 2.7\text{V}$			20	μA
I_{IL}	Enable Input Current LOW	$V_{IL} = 0.4\text{V}$			-100	μA
R_I	Input Resistance			12		k Ω
I_{OS}	Short Circuit Output Current	(Note 10)	-15		-85	mA
I_{CC}	Supply Current (Total Package)	No Load	Outputs Enabled		40	mA
			Outputs Disabled			

Driver Switching Characteristics

$V_{CC} = 5\text{V}$, $T_A = 25^\circ\text{C}$

Symbol	Parameter	Conditions	Min	Typ	Max	Units
t_{DD}	Differential Output Delay Time	$R_L = 60\Omega$, <i>Figure 4</i>		15	25	ns
t_{TD}	Differential Output Transition Time	$R_L = 60\Omega$, <i>Figure 4</i>		15	25	ns
t_{PLH}	Propagation Delay Time, Low-to-High Level Output	$R_L = 27\Omega$, <i>Figure 5</i>		12	20	ns
t_{PHL}	Propagation Delay Time, High-to-Low Level Output	$R_L = 27\Omega$, <i>Figure 5</i>		12	20	ns
t_{PZH}	Output Enable Time to High Level	$R_L = 110\Omega$, <i>Figure 6</i>		25	35	ns
t_{PZL}	Output Enable Time to Low Level	$R_L = 110\Omega$, <i>Figure 7</i>		25	35	ns
t_{PHZ}	Output Disable Time from High Level	$R_L = 110\Omega$, <i>Figure 6</i>		20	25	ns
t_{PLZ}	Output Disable Time from Low Level	$R_L = 110\Omega$, <i>Figure 7</i>		29	35	ns

Receiver Switching Characteristics

$V_{CC} = 5.0\text{V}$, $T_A = 25^\circ\text{C}$

Symbol	Parameter	Conditions	Min	Typ	Max	Units
t_{PLH}	Propagation Delay Time, Low-to-High Level Output	$V_{ID} = 0\text{V to }3.0\text{V}$ $C_L = 15\text{ pF}$, <i>Figure 8</i>		16	25	ns
t_{PHL}	Propagation Delay Time, High-to-Low Level Output			16	25	ns
t_{PZH}	Output Enable Time to High Level	$C_L = 15\text{ pF}$, <i>Figure 9</i>		15	22	ns
t_{PZL}	Output Enable Time to Low Level			15	22	ns
t_{PHZ}	Output Disable Time from High Level	$C_L = 5.0\text{ pF}$, <i>Figure 9</i>		14	30	ns
t_{PLZ}	Output Disable Time from Low Level			24	40	ns

Note 2: "Absolute Maximum Ratings" are those values beyond which the safety of the device cannot be guaranteed. They are not meant to imply that the devices should be operated at these limits. The tables of "Electrical Characteristics" provide conditions for actual operation.

Note 3: Unless otherwise specified min/max limits apply across the 0°C to $+70^\circ\text{C}$ range for the DS96176. All typicals are given for $V_{CC} = 5\text{V}$ and $T_A = 25^\circ\text{C}$.

Note 4: All currents into the device pins are positive; all currents out of the device pins are negative. All voltages are referenced to ground unless otherwise specified.

Note 5: $\Delta|V_{OD}|$ and $\Delta|V_{OC}|$ are the changes in magnitude of V_{OD} and V_{OC} , respectively, that occur when the input is changed from a high level to a low level.

Note 6: In EIA Standards RS-422A and RS-485, V_{OC} , which is the average of the two output voltages with respect to ground, is called output offset voltage, V_{OS} .

Note 7: The algebraic convention, where the less positive (more negative) limit is designated minimum, is used in this data sheet for common mode input voltage and threshold voltage levels only.

Receiver Switching Characteristics (Continued)

Note 8: Hysteresis is the difference between the positive-going input threshold voltage V_{T+} , and the negative-going input threshold voltage, V_{T-} .

Note 9: Refer to EIA Standard RS-485 for exact conditions.

Note 10: Only one output at a time should be shorted.

Parameter Measurement Information

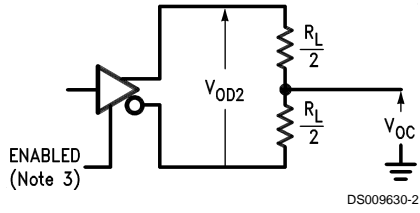

FIGURE 1. Driver V_{OD} and V_{OC}

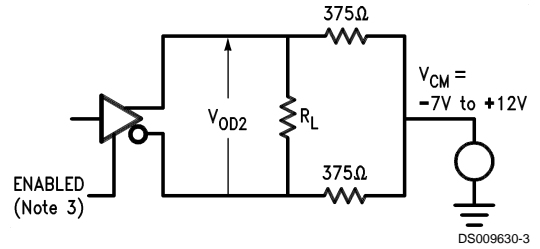

FIGURE 2. Driver V_{OD} with Varying Common Mode Voltage

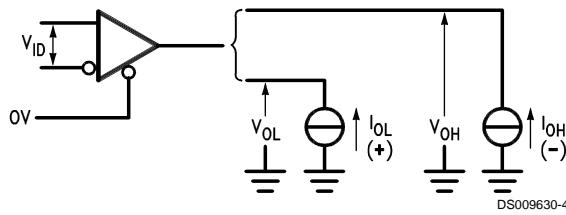

FIGURE 3. Receiver V_{OH} and V_{OL}

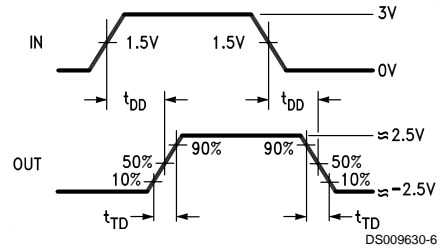
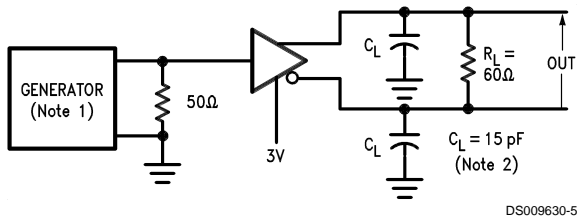

FIGURE 4. Driver Differential Output Delay and Transition Times

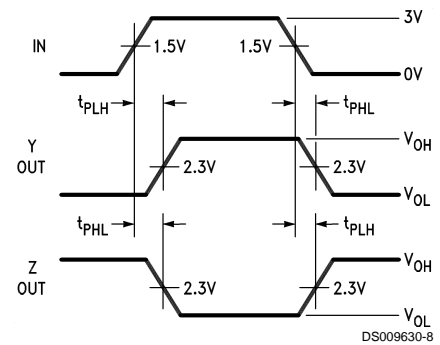
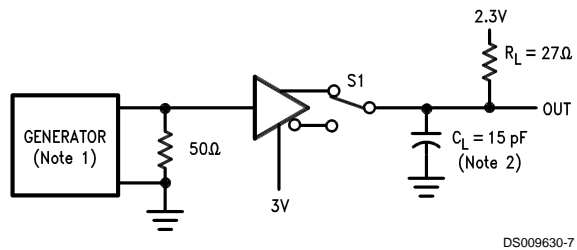
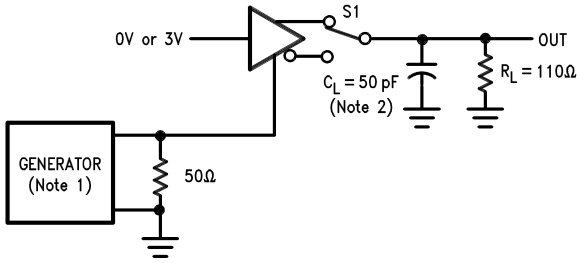

FIGURE 5. Driver Propagation Times

Parameter Measurement Information (Continued)



DS009630-9

FIGURE 6. Driver Enable and Disable Times (t_{PZH} , t_{PHZ})

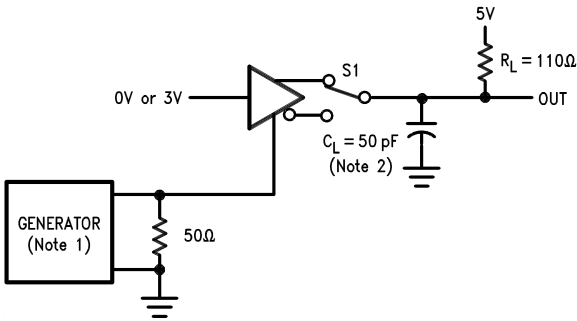
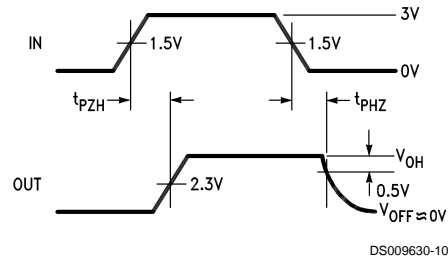

DS009630-11

FIGURE 7. Driver Enable and Disable Times (t_{PZL} , t_{PLZ})

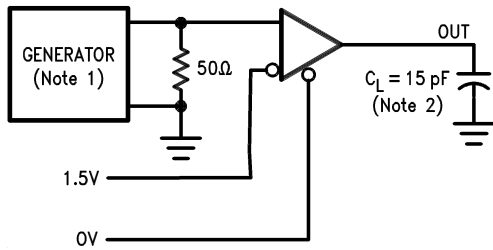
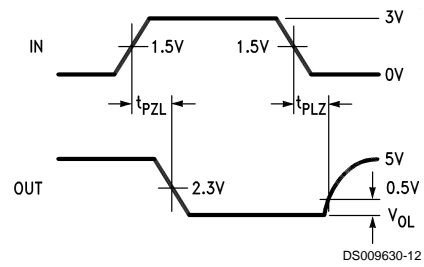

DS009630-13

FIGURE 8. Receiver Propagation Delay Times

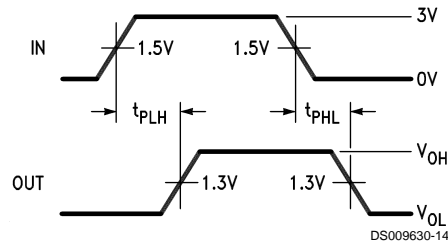

Parameter Measurement Information (Continued)

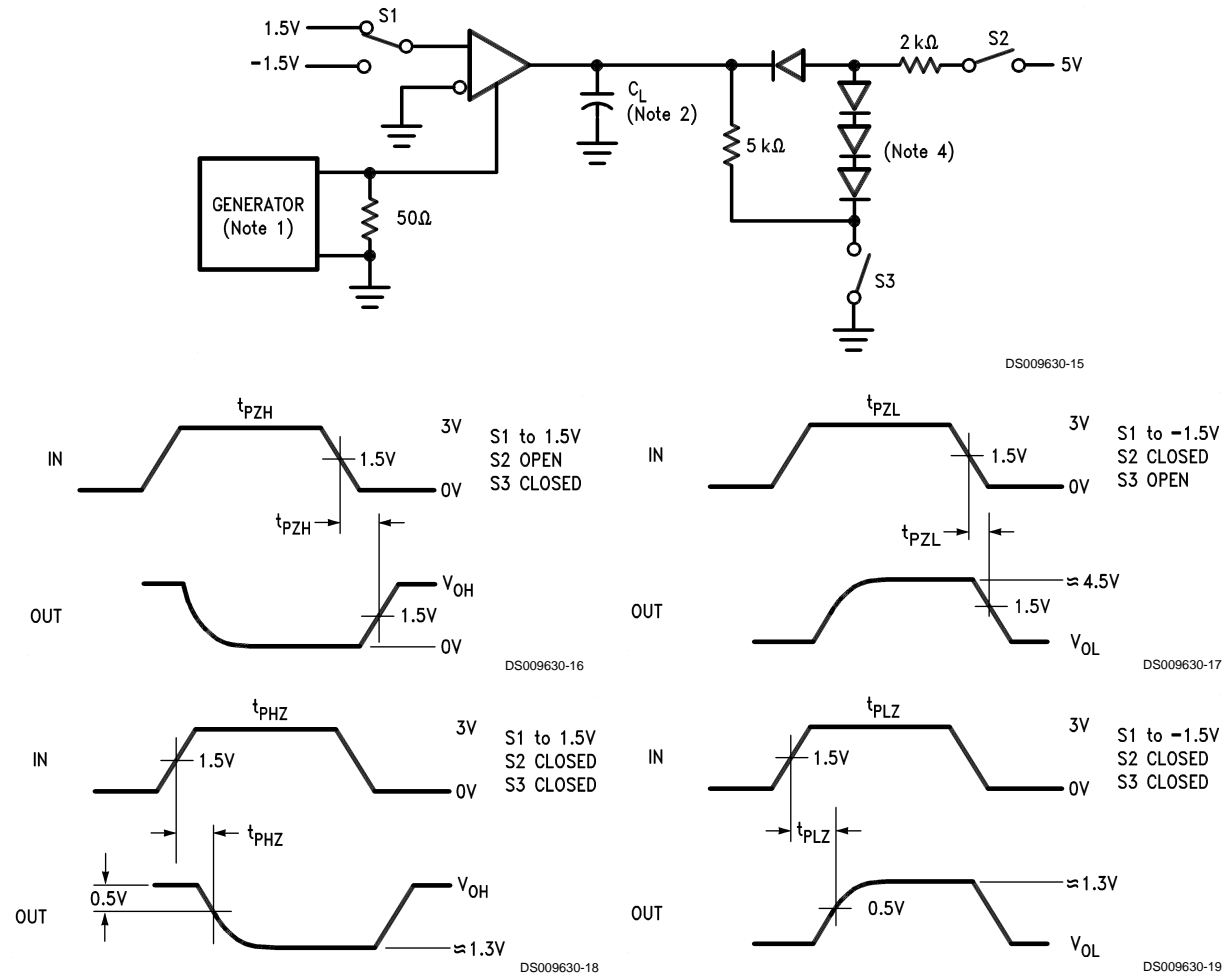

- Note 11:** The input pulse is supplied by a generator having the following characteristics: PRR = 1.0 MHz, 50% duty cycle, $t_r \leq 6.0$ ns, $Z_O = 50\Omega$.
- Note 12:** C_L includes probe and stray capacitance.
- Note 13:** DS96176 Driver enable is Active-High.
- Note 14:** All diodes are 1N916 or equivalent.

FIGURE 9. Receiver Enable and Disable Times

Typical Application

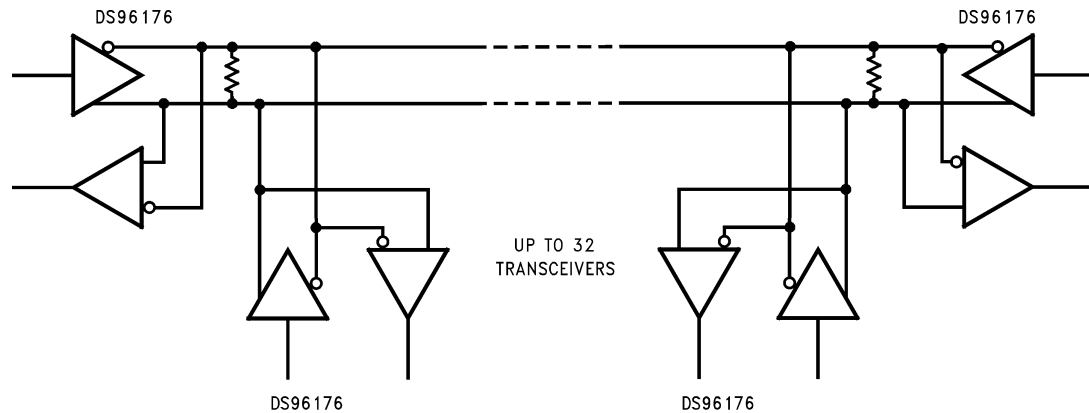

- Note:** The line length should be terminated at both ends of its characteristic impedance. Stub lengths off the main line should be kept as short as possible.

FIGURE 10.

Typical Performance Characteristics

Driver Differential Propagation Delay vs V_{CC} vs Temperature

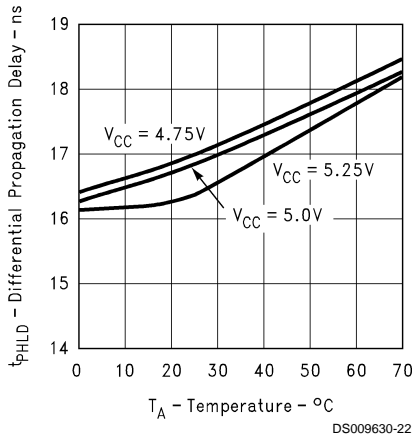

Driver Differential Propagation Delay vs V_{CC} vs Temperature

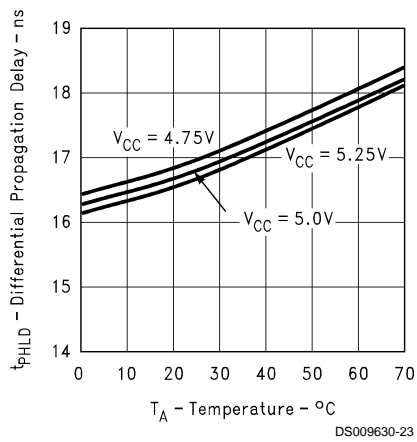

Driver Differential Rise Time vs V_{CC} vs Temperature

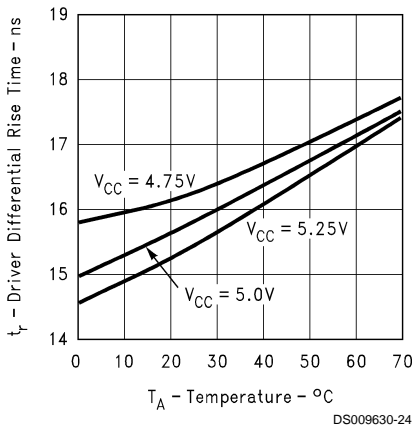

Driver Differential Fall Time vs V_{CC} vs Temperature

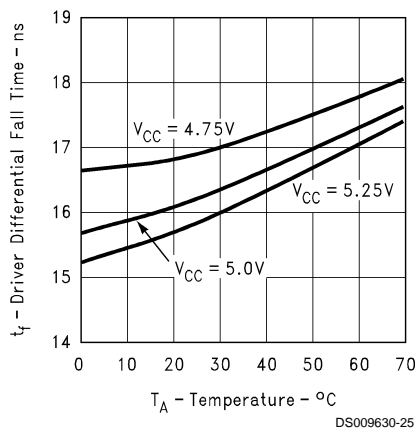

**Driver Skew vs V_{CC} vs Temperature
($t_{PLDH} - t_{PHLD}$)**

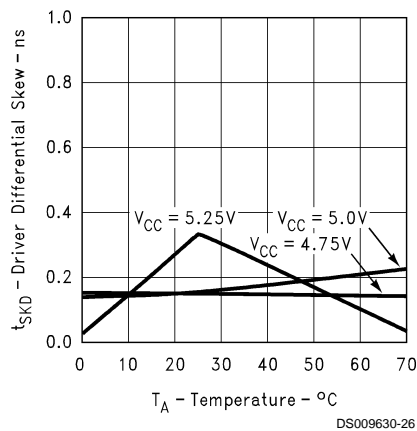

Typical Performance Characteristics (Continued)

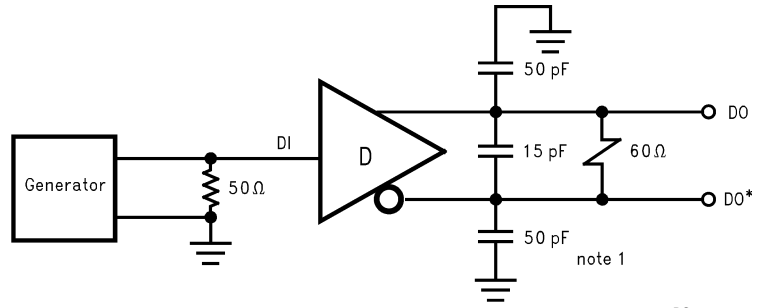

DS009630-27

FIGURE 11. Typical Curve Driver Propagation Delay Test Circuit

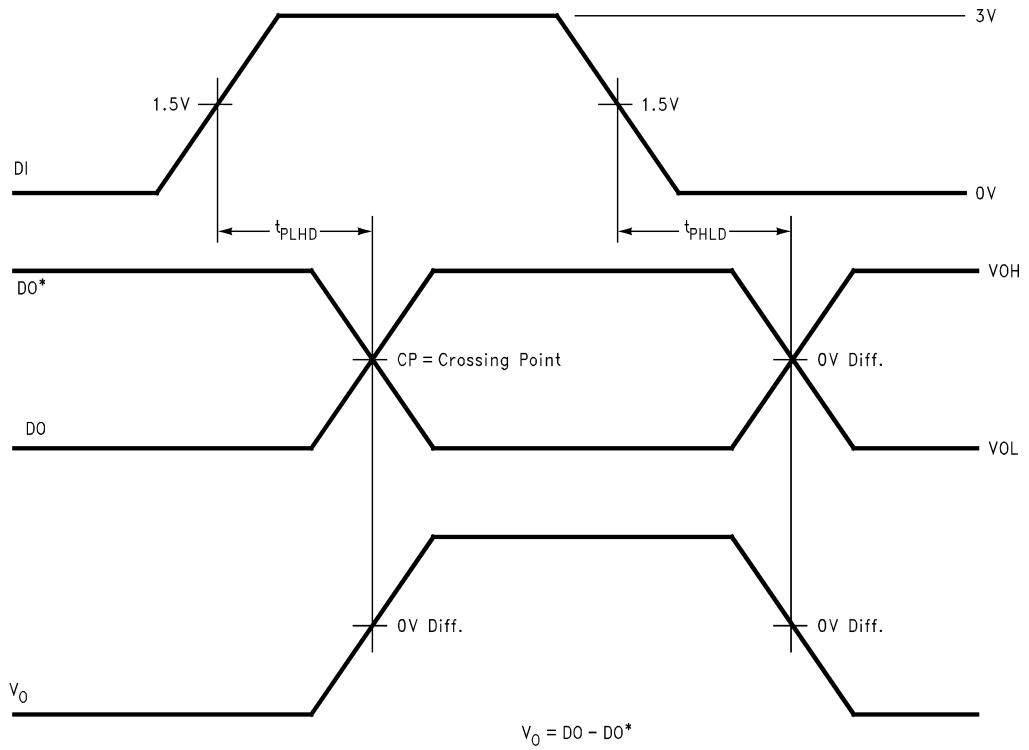

DS009630-28

FIGURE 12. Typical Curve Driver Differential Propagation Delay Timing

Typical Performance Curves

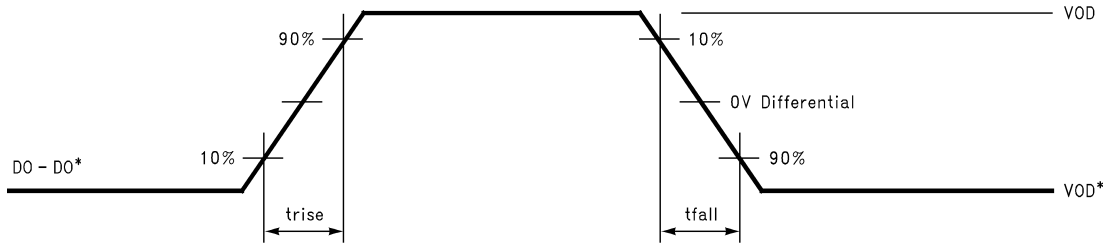

DS009630-29

FIGURE 13. Typical Curve Driver Differential Rise and Fall Times

Receiver Propagation Delay vs V_{CC} vs Temperature

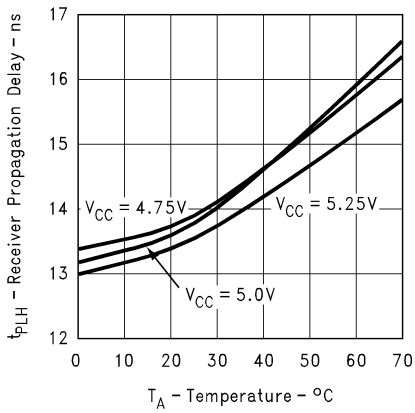

DS009630-30

Receiver Propagation Delay vs V_{CC} vs Temperature

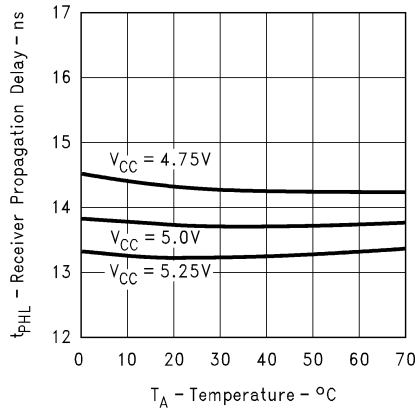

DS009630-31

Receiver Skew vs V_{CC} vs Temperature ($t_{PLH} - t_{PHL}$)

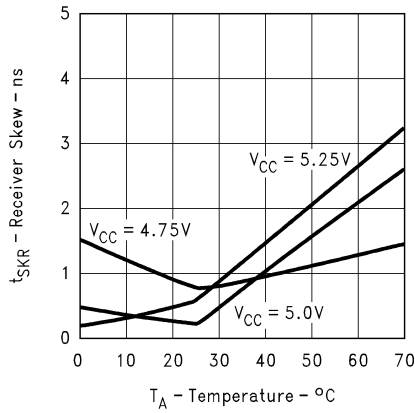

DS009630-32

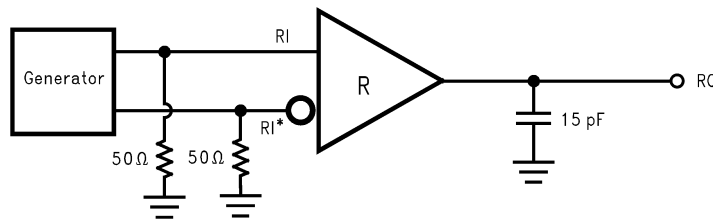

DS009630-33

FIGURE 14. Typical Curve Receiver Differential Propagation Delay Test Circuit

Typical Performance Curves (Continued)

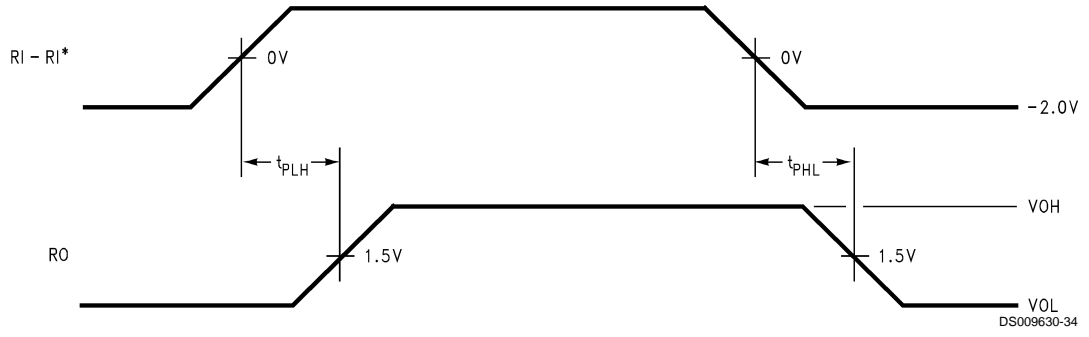
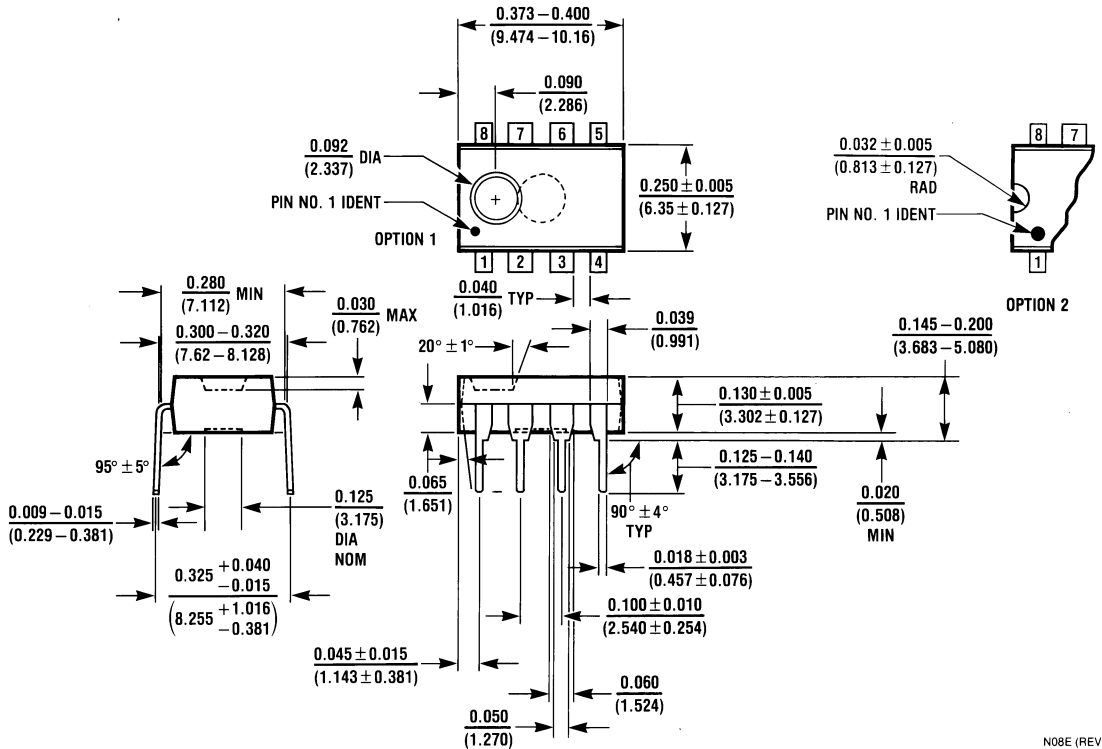

FIGURE 15. Typical Curve Receiver Propagation Delay Timing

Physical Dimensions inches (millimeters) unless otherwise noted



Molded Dual-In-Line Package (N)
Order Number DS96176CN
NS Package Number N08E

N08E (REV F)

LIFE SUPPORT POLICY

NATIONAL'S PRODUCTS ARE NOT AUTHORIZED FOR USE AS CRITICAL COMPONENTS IN LIFE SUPPORT DEVICES OR SYSTEMS WITHOUT THE EXPRESS WRITTEN APPROVAL OF THE PRESIDENT AND GENERAL COUNSEL OF NATIONAL SEMICONDUCTOR CORPORATION. As used herein:

1. Life support devices or systems are devices or systems which, (a) are intended for surgical implant into the body, or (b) support or sustain life, and whose failure to perform when properly used in accordance with instructions for use provided in the labeling, can be reasonably expected to result in a significant injury to the user.
2. A critical component is any component of a life support device or system whose failure to perform can be reasonably expected to cause the failure of the life support device or system, or to affect its safety or effectiveness.

 **National Semiconductor Corporation**
 Americas
 Email: support@nsc.com

National Semiconductor Europe
 Fax: +49 (0) 180-530 85 86
 Email: europe.support@nsc.com
 Deutsch Tel: +49 (0) 69 9508 6208
 English Tel: +44 (0) 870 24 0 2171
 Français Tel: +33 (0) 1 41 91 8790

National Semiconductor Asia Pacific Customer Response Group
 Tel: 65-2544466
 Fax: 65-2504466
 Email: ap.support@nsc.com

National Semiconductor Japan Ltd.
 Tel: 81-3-5639-7560
 Fax: 81-3-5639-7507

www.national.com

IMPORTANT NOTICE

Texas Instruments Incorporated and its subsidiaries (TI) reserve the right to make corrections, modifications, enhancements, improvements, and other changes to its products and services at any time and to discontinue any product or service without notice. Customers should obtain the latest relevant information before placing orders and should verify that such information is current and complete. All products are sold subject to TI's terms and conditions of sale supplied at the time of order acknowledgment.

TI warrants performance of its hardware products to the specifications applicable at the time of sale in accordance with TI's standard warranty. Testing and other quality control techniques are used to the extent TI deems necessary to support this warranty. Except where mandated by government requirements, testing of all parameters of each product is not necessarily performed.

TI assumes no liability for applications assistance or customer product design. Customers are responsible for their products and applications using TI components. To minimize the risks associated with customer products and applications, customers should provide adequate design and operating safeguards.

TI does not warrant or represent that any license, either express or implied, is granted under any TI patent right, copyright, mask work right, or other TI intellectual property right relating to any combination, machine, or process in which TI products or services are used. Information published by TI regarding third-party products or services does not constitute a license from TI to use such products or services or a warranty or endorsement thereof. Use of such information may require a license from a third party under the patents or other intellectual property of the third party, or a license from TI under the patents or other intellectual property of TI.

Reproduction of TI information in TI data books or data sheets is permissible only if reproduction is without alteration and is accompanied by all associated warranties, conditions, limitations, and notices. Reproduction of this information with alteration is an unfair and deceptive business practice. TI is not responsible or liable for such altered documentation. Information of third parties may be subject to additional restrictions.

Resale of TI products or services with statements different from or beyond the parameters stated by TI for that product or service voids all express and any implied warranties for the associated TI product or service and is an unfair and deceptive business practice. TI is not responsible or liable for any such statements.

TI products are not authorized for use in safety-critical applications (such as life support) where a failure of the TI product would reasonably be expected to cause severe personal injury or death, unless officers of the parties have executed an agreement specifically governing such use. Buyers represent that they have all necessary expertise in the safety and regulatory ramifications of their applications, and acknowledge and agree that they are solely responsible for all legal, regulatory and safety-related requirements concerning their products and any use of TI products in such safety-critical applications, notwithstanding any applications-related information or support that may be provided by TI. Further, Buyers must fully indemnify TI and its representatives against any damages arising out of the use of TI products in such safety-critical applications.

TI products are neither designed nor intended for use in military/aerospace applications or environments unless the TI products are specifically designated by TI as military-grade or "enhanced plastic." Only products designated by TI as military-grade meet military specifications. Buyers acknowledge and agree that any such use of TI products which TI has not designated as military-grade is solely at the Buyer's risk, and that they are solely responsible for compliance with all legal and regulatory requirements in connection with such use.

TI products are neither designed nor intended for use in automotive applications or environments unless the specific TI products are designated by TI as compliant with ISO/TS 16949 requirements. Buyers acknowledge and agree that, if they use any non-designated products in automotive applications, TI will not be responsible for any failure to meet such requirements.

Following are URLs where you can obtain information on other Texas Instruments products and application solutions:

Products

Audio	www.ti.com/audio
Amplifiers	amplifier.ti.com
Data Converters	dataconverter.ti.com
DLP® Products	www.dlp.com
DSP	dsp.ti.com
Clocks and Timers	www.ti.com/clocks
Interface	interface.ti.com
Logic	logic.ti.com
Power Mgmt	power.ti.com
Microcontrollers	microcontroller.ti.com
RFID	www.ti-rfid.com
OMAP Mobile Processors	www.ti.com/omap
Wireless Connectivity	www.ti.com/wirelessconnectivity

Applications

Communications and Telecom	www.ti.com/communications
Computers and Peripherals	www.ti.com/computers
Consumer Electronics	www.ti.com/consumer-apps
Energy and Lighting	www.ti.com/energy
Industrial	www.ti.com/industrial
Medical	www.ti.com/medical
Security	www.ti.com/security
Space, Avionics and Defense	www.ti.com/space-avionics-defense
Transportation and Automotive	www.ti.com/automotive
Video and Imaging	www.ti.com/video

TI E2E Community Home Page

e2e.ti.com

Mailing Address: Texas Instruments, Post Office Box 655303, Dallas, Texas 75265
Copyright © 2011, Texas Instruments Incorporated







Looking for pricing, stock, or lifecycle information?

Click below to explore more details on WIN SOURCE:

 [View DS96176CN/NOPB on WIN SOURCE](#)

 [Texas Instruments](#) Information

Optimize Your Supply Chain with WIN SOURCE Solutions

-  Global Sourcing Solution
-  Obsolete Management
-  Cost Control Management
-  Shortage Management
-  Alternative Solution
-  Excess Inventory Management