



**THE DATASHEET OF**  
**2866048**



# EMD-FL-V-300

## Electronic monitoring relay for voltage monitoring of direct and alternating voltages in single-phase networks

### INTERFACE

Data sheet  
102058\_en\_04

© PHOENIX CONTACT - 09/2009



### 1 Description

Increasingly higher demands are being placed on safety and system availability – across all sectors. Processes are becoming more and more complex, not only in mechanical engineering and the chemical industry, but also in plant and automation technology. Demands on power engineering are also increasing constantly.

Error-free and therefore cost-effective operation can only be achieved through continuous monitoring of important network and system parameters. Electronic monitoring relays in the EMD series are available for a wide range of monitoring tasks to avoid the consequences of errors or to keep them within limits.

The operating states are indicated using colored LEDs, errors that may occur can be sent to a control system via a floating contact or can shut down a part of the system. Some device versions are equipped with startup and response delays in order to briefly tolerate measured values outside the set monitoring range.

### Features

- Surge voltage/undervoltage monitoring
- Window function
- Adjustable threshold values
- Adjustable starting override
- Adjustable response delay
- Error memory
- Wide-range power supply unit
- Two PDTs

**WARNING: Risk of electric shock**

Never carry out work when voltage is present.



Make sure you always use the the latest documentation.  
It can be downloaded at [www.phoenixcontact.net/download](http://www.phoenixcontact.net/download).

## 2 Ordering data

Description	Type	Order No.	Pcs. / Pkt.
Electronic monitoring relay for voltage monitoring of direct and alternating voltages in single-phase networks	EMD-FL-V-300	2866048	1

## 3 Technical data

Input data	
Input name	Measuring input
Measured value	DC, AC sine
Protection	max. 20 A
Input voltage range	0 V ... 30 V AC/DC (connection terminal blocks: U1 and GND) 0 V ... 60 V AC/DC (connection terminal blocks: U2 and GND) 0 V ... 300 V AC/DC (connection terminal blocks: U3 and GND)
Maximum input voltage	100 V <sub>rms</sub> (connection terminal blocks: U1 and GND) 150 V <sub>rms</sub> (connection terminal blocks: U2 and GND) 440 V <sub>rms</sub> (connection terminal blocks: U3 and GND)
Input resistance of voltage input	47 kΩ (connection terminal blocks: U1 and GND) 100 kΩ (connection terminal blocks: U2 and GND) 470 kΩ (connection terminal blocks: U3 and GND)
Maximum temperature coefficient	< 0.1 %/K
Setting range for response delay	0.1 s ... 10 s
Setting range for starting delay	0 s ... 10 s
Min. setting range	5 % ... 95 % (From U <sub>N</sub> )
Max. setting range	10 % ... 100 % (From U <sub>N</sub> )
Function	Undervoltage, overvoltage, window
Basic accuracy	± 5 % (of scale end value)
Setting accuracy	≤ 5 % (of scale end value)
Repeat accuracy	≤ 2 %
Recovery time	500 ms
Output data	
Contact type	2 floating PDT contacts
Nominal insulation voltage	250 V AC (in acc. with IEC 60664-1)
Interrupting rating (ohmic load) max.	750 VA (3 A/250 V AC, module aligned, ≤ 5 mm spacing) 1250 VA (5 A/250 V AC, module not aligned, ≥ 5 mm spacing)
Output fuse	5 A (fast-blow)
Supply	
Range of supply voltages	24 V AC ... 240 V AC -15 % ... +10 % 24 V DC ... 240 V DC -20 % ... +25 %
Frequency range	48 Hz ... 400 Hz
Nominal power consumption	4.5 VA (1.5 W)
General data	
Mains type	1-phase
Service life mechanical	Approx. 2 x 10 <sup>7</sup> cycles
Service life, electrical	2 x 10 <sup>5</sup> cycles at ohmic load, 1000 VA
Switching frequency	max. 60 (per minute at 100 VA ohmic load) max. 6 (per minute at 1000 VA ohmic load)
Operating mode	100% operating factor
Degree of protection	IP40 (housing) / IP20 (connection terminal blocks)

**General data**

Pollution degree	2 (according to EN 50178)
Surge voltage category	III, basic insulation (as per EN 50178)
Rated insulation voltage	300 V (According to EN 50178)
Assembly	on TS 35 profile rail acc. to EN 60715
Mounting position	Any
Width	22.5 mm
Height	113 mm
Length	90 mm
Type of housing	Polyamide PA, self-extinguishing
Color	green
Weight	160 g

**Connection data**

Conductor cross section, solid	0.5 mm <sup>2</sup> ... 2.5 mm <sup>2</sup>
Conductor cross section, stranded	0.25 mm <sup>2</sup> ... 2.5 mm <sup>2</sup>
Stripping length	8 mm
Type of connection	Screw connection
Tightening torque	1 Nm

**Ambient conditions**

Ambient temperature (operation)	-25 °C ... 55 °C -25 °C ... 40 °C (corresponds to UL 508)
Ambient temperature (storage/transport)	-25 °C ... 70 °C
Permissible humidity (operation)	15 % ... 85 %
Climatic class	3K3 (in acc. with EN 60721)

**Conformance / approvals**

Conformity	CE compliant
UL, USA / Canada	UL/C-UL listed UL 508

**Conformance with EMC directive 2004/108/EC**

Immunity to interference according to	EN 61000-6-2
Emitted interference according to	EN 61000-6-4

**Conformance with LV directive 2006/95/EC**

Electronic equipm. for electrical power installations according to	EN 50178
--	----------

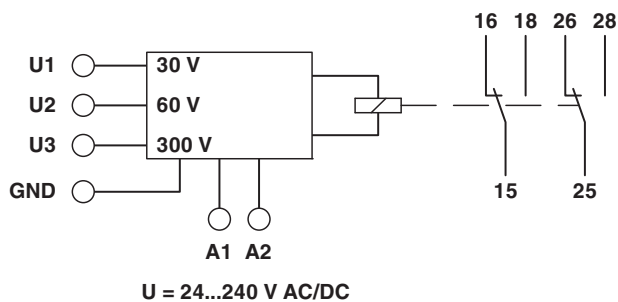
**4 Block diagram**

## 5 Safety notes



### WARNING: Risk of electric shock

Never carry out work when voltage is present.

## 6 Structure

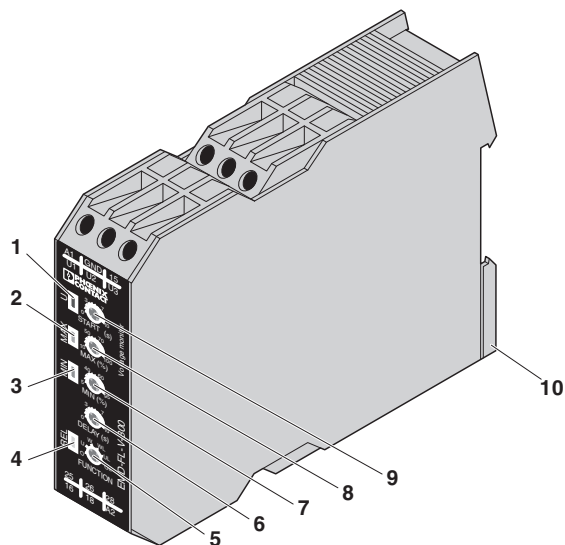

- 1 "U" LED: Supply voltage
- 2 "MAX" LED: Upper threshold value
- 3 "MIN" LED: Lower threshold value
- 4 "REL" LED: Output relay
- 5 "FUNCTION" rotary switch: Function selection
- 6 "DELAY" potentiometer: Response delay
- 7 "MIN" potentiometer: Lower threshold value
- 8 "MAX" potentiometer: Upper threshold value
- 9 "START" potentiometer: Starting override
- 10 Universal snap-on foot for EN DIN rails

## 7 Installation



### WARNING: Risk of electric shock

Never carry out work when voltage is present.

The module can be snapped onto all 35 mm DIN rails according to EN 60715.

An integrated wide-range power supply unit enables the connection of a supply voltage in the range from 24 V AC/DC to 240 V AC/DC.

## 8 Diagnostics

The LEDs indicate the following error states:

### "U" LED (Green)

- LED ON: Supply voltage present

### "MIN" and "MAX" LEDs (Red)

- LED flashes: Set threshold value exceeded, set delay time is running
- LED ON: Set threshold value exceeded, delay time has elapsed
- Both LEDs flash alternately: Lower set threshold value is greater than upper threshold value

### "REL" LED (Yellow)

- LED ON: Output relay has picked up
- LED OFF: Output relay has dropped out

## 9 Connection examples

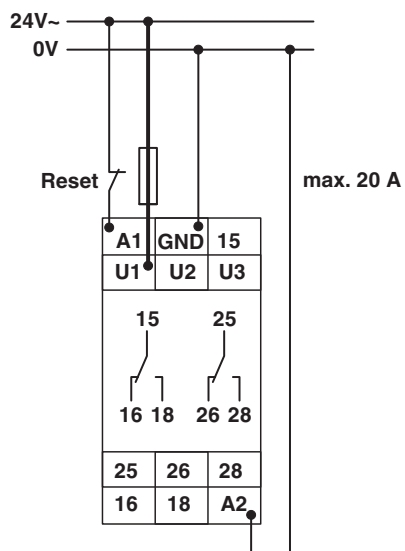

30 V measuring range (U1)

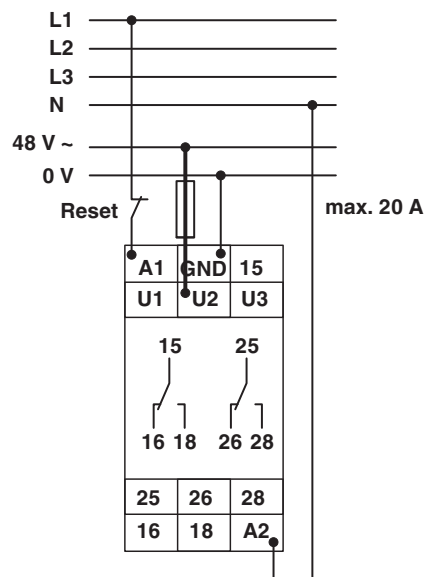

60 V measuring range (U2)

## 10

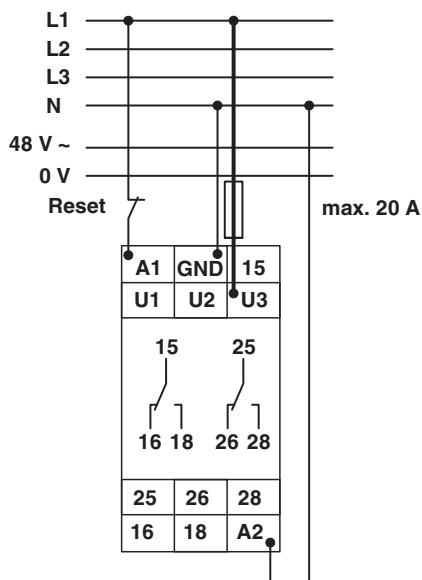

300 V measuring range (U3)

## 11 Function

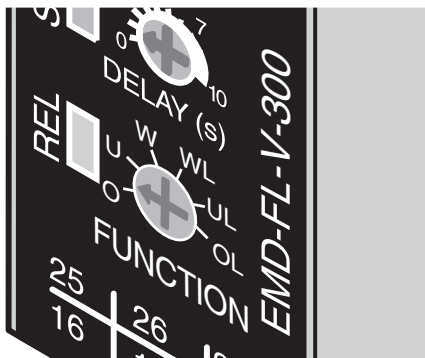

When supply voltage U is applied, output relay "R" picks up (yellow "REL" LED is ON) and the starting override (START) starts (green "U" LED flashes). During the starting override, modifications to the measured value have no influence on the position of the output relay. Once the starting override has elapsed, the green "U" LED lights up permanently. For all functions the "MIN" and "MAX" LEDs flash alternately if the minimum value selected is greater than the maximum value.

The "FUNCTION" rotary switch is used to set the desired function:

- O = Surge voltage monitoring (OVER)
- U = Undervoltage monitoring (UNDER)
- W = Monitoring of the area between thresholds MIN and MAX (window function) (WIN)
- WL = Monitoring of the area between thresholds MIN and MAX (window function) with error memory (WIN + LATCH)
- UL = Undervoltage monitoring with error memory (UNDER + LATCH)
- OL = Surge voltage monitoring with error memory (OVER + LATCH)

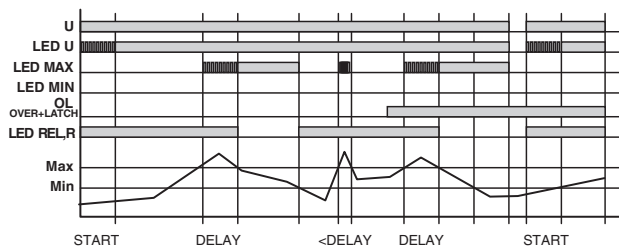

### Surge Voltage Monitoring (OVER and OVER + LATCH)

If the measured voltage exceeds the value set at the "MAX" controller, the set response delay (DELAY) starts (red "MAX" LED flashes). After the delay time has elapsed (red "MAX" LED is ON), output relay "R" drops out (yellow "REL" LED is OFF). If the measured voltage falls below the value set at the "MIN" controller (red "MAX" LED is OFF), output relay "R" picks up again (yellow "REL" LED is ON).

If the error memory has been activated (OVER + LATCH) and the measured voltage has exceeded the value set at the "MAX" controller for longer than the set response delay, output relay "R" does not pick up if the voltage falls below the value set at the "MIN" controller.

Once the error has been reset (supply voltage interrupted), output relay "R" picks up when the supply voltage is applied again and the measuring cycle starts again once the set starting override (START) has elapsed.

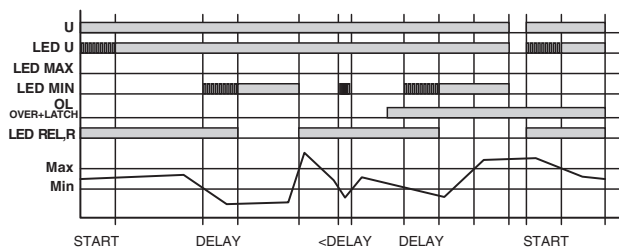

### Undervoltage Monitoring (UNDER and UNDER + LATCH)

If the measured voltage falls below the value set at the "MIN" controller, the set response delay (DELAY) starts (red "MIN" LED flashes). After the delay time has elapsed (red "MIN" LED is ON), output relay "R" drops out (yellow "REL" LED is OFF). If the measured voltage exceeds the value set at the "MAX" controller, output relay "R" picks up again (yellow "REL" LED is ON).

If the error memory has been activated (UNDER + LATCH) and the measured voltage has fallen below the value set at the "MIN" controller for longer than the set response delay, output relay "R" does not pick up if the voltage exceeds the value set at the "MAX" controller.

Once the error has been reset (supply voltage interrupted), output relay "R" picks up when the supply voltage is applied again and the measuring cycle starts again once the set starting override (START) has elapsed.

**Window Function (WIN and WIN + LATCH)**

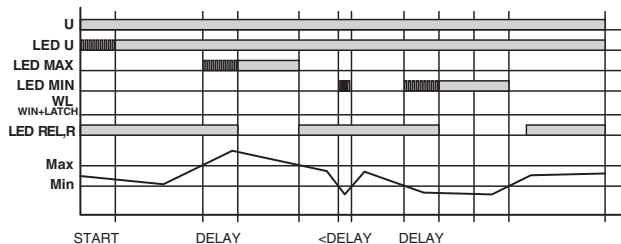

Output relay "R" picks up (yellow "REL" LED is ON) if the measured voltage exceeds the value set at the "MIN" controller. If the measured voltage exceeds the value set at the "MAX" controller, the set response delay (DELAY) starts (red "MAX" LED flashes). After the delay time has elapsed (red "MAX" LED is ON), output relay "R" drops out (yellow "REL" LED is OFF).

Output relay "R" picks up again (yellow "REL" LED is ON) if the measured voltage falls below the maximum value again (red "MAX" LED is OFF). If the measured voltage falls below the value set at the "MIN" controller, the set response delay (DELAY) starts (red "MIN" LED flashes). After the delay time has elapsed (red "MIN" LED is ON), output relay "R" drops out (yellow "REL" LED is OFF).

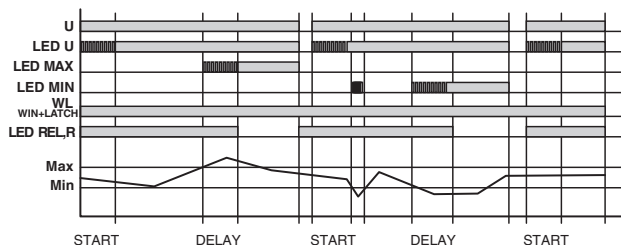



If the error memory has been activated (WIN + LATCH) and the measured voltage has fallen below the value set at the "MIN" controller for longer than the set response delay, output relay "R" does not pick up if the minimum value is exceeded. If the measured voltage has exceeded the value set at the "MAX" controller for longer than the set response delay, output relay "R" likewise does not pick up when the voltage falls below the maximum value.





Once the error has been reset (supply voltage interrupted), output relay "R" picks up when the supply voltage is applied again and the measuring cycle starts again once the set starting override (START) has elapsed.

## Looking for pricing, stock, or lifecycle information?

Click below to explore more details on WIN SOURCE:

-  [View 2866048 on WIN SOURCE](#)
-  [Phoenix Contact Information](#)

## Optimize Your Supply Chain with WIN SOURCE Solutions

-  Global Sourcing Solution
-  Obsolete Management
-  Cost Control Management
-  Shortage Management
-  Alternative Solution
-  Excess Inventory Management