



**THE DATASHEET OF
1963200000**



Industrial Ethernet Catalogue 2016/2017

Let's connect.

Industrial data communication



Weidmüller 

Dear Customers,

The PDF versions of our catalogues offer practical additional functions, helping you to find your way around our product range and simplifying the ordering process.

In addition to the catalogue, the PDF also contains:

- Internal page links
- Links to the online catalogue

Try it out for yourself. Click the order number to obtain more detailed information and close-up images via you web browser. The links in the PDF file also enable you to go directly to the next desired catalogue page.

Further Weidmüller product catalogues can be accessed by clicking the following:



Industrial Ethernet

Solutions for industrial data communications

Active components

Introduction - Active components

Industrial Ethernet Switches

Industrial Security Router

Media converter and protocol gateways

Industrial wireless

Accessories - Active components

Passive components

Introduction - Passive components

IP 20 plug-in connectors and mounting rail outlets

IP 65 service interface FrontCom®

IP 67 plug-in connectors

IP 65 connection components / FreeCon connectivity components

Copper cabling solutions

Fibre-optic cabling solutions

Accessories - Passive components

Appendix

Technical appendix

Added value for your application / Glossary

Index

Search according to type or order number

Active components

An overview of our portfolio

**Unmanaged Switches
Fast Ethernet**
Page B.3



**Unmanaged Switches
Gigabit Ethernet**
Page B.6



**Managed Switches
Fast Ethernet**
Page B.13



**Managed Switches
Gigabit Ethernet**
Page B.16



**Power-over-Ethernet-Switches
(managed/unmanaged)**
Page B.21



Industrial Security Router
Page C.6



Media converter (copper/fibre-optic)
Page D.3



Serial/Ethernet converter
Page D.5



Serial/fibre-optic converter
Page D.7



Modbus TCP/RTU Gateway
Page D.8



**Industrial wireless
(Access Point/ Bridge/Client)**
Page E.5



Active components

Accessories from a single source

WLAN antennas and connection cables

Page F.2



Mobile radio antennas and connection cables

Page F.6

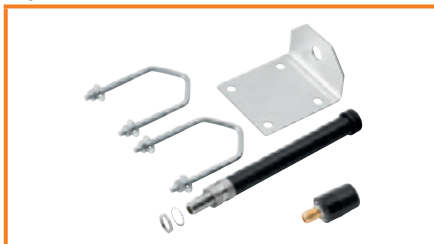

SFP modules (Fast Ethernet/Gigabit Ethernet)

Page F.8



External Backup and Restore Module for System Configuration

Page F.9



Kit for 19" rack-mounting

Page F.10



Passive components

An overview of our portfolio

PROFINET and SERCOS III cabling solutions

Page G.10



EtherNet/IP cabling solutions

Page G.14



IP 20 plug-in connectors

Page H.2



RJ 45 PCB socket

Page H.10



IP 20 mounting rail outlets

Page H.8



IP 65 service interface FrontCom®

Page I.2



IP 67 plug-in connectors

Page J.2



IP 65 connection components / connectivity components FreeCon

Page K.2



IP 65 FreeCon Active PROFINET

Page K.9



IP 65 Contactless Power Transmission FreeCon Contactless Power

Page K.10



Cabling solutions

An overview of our portfolio

Installation cables
Page L.6



Connecting cables
Page L.8



Dragline cables
Page L.13



RJ45 patch cables
Page L.17



System cables assembled
Page L.27



FO connecting cables
Page M.5



FO patch cables
Page M.7



FO system cables
Page M.13



Passive components

Accessories from a single source

Cable connector
Page N.3



Tools Copper cabling
Page N.4



Tools Fibre-optic cabling
Page N.10



General tools
Page N.16



Cabtite®
Page N.18



Protective caps
Page N.21



Inkjet printer
Page N.23



Markers
Page N.24



Intended use for Industrial Ethernet

A complete range of products for industrial communications infrastructure

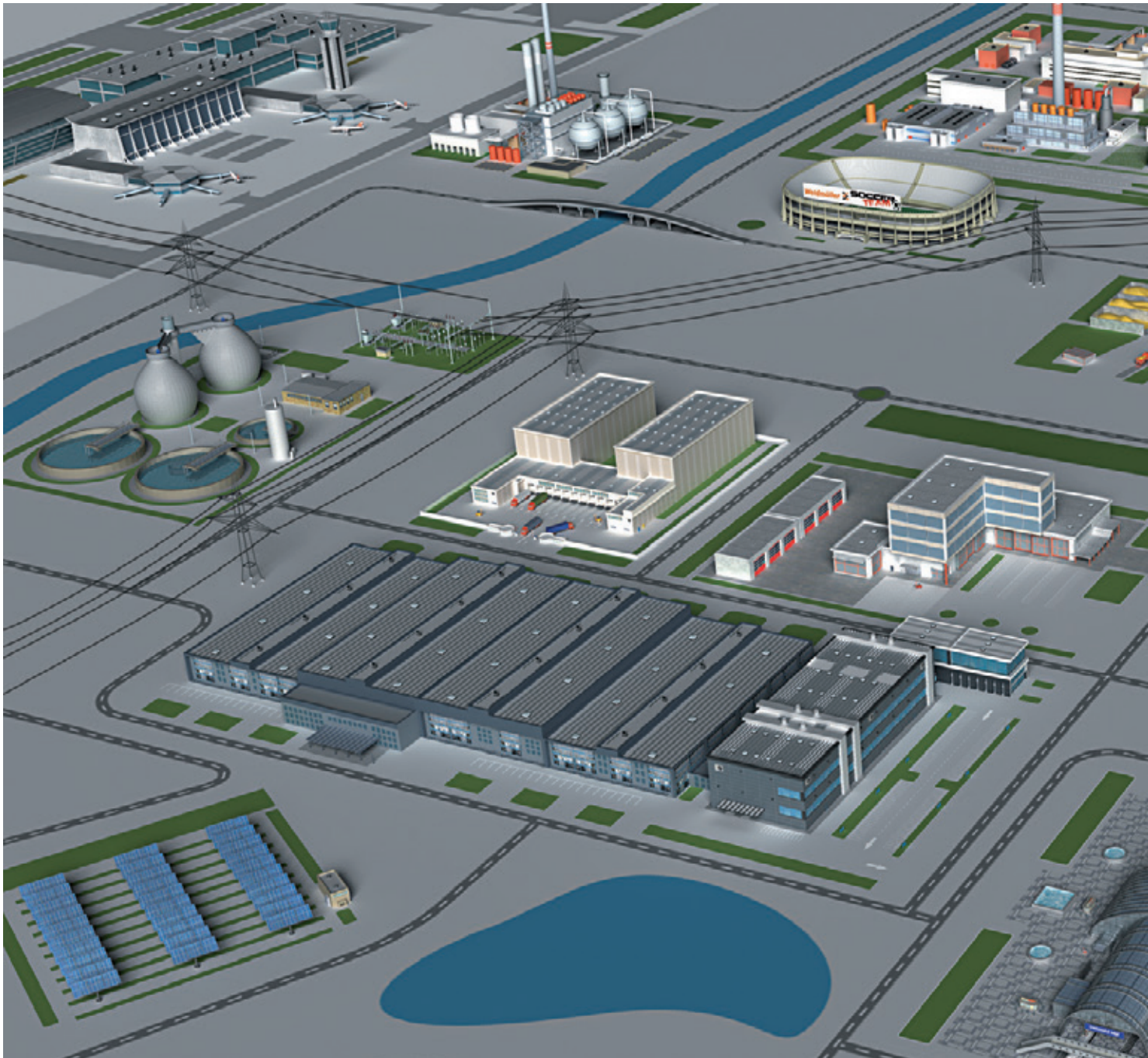

The trend to network industrial plant components using Ethernet protocols was already apparent several years ago. Ethernet communication is now well established in all market segments; including automotive, general machine construction, process industry, transportation and energy. The requirements of these differ in terms of protocols, environmental conditions, certifications and standards. As

well as being a leading provider of industrial connection and network products, Weidmüller embraces solutions for these differing requirements with a comprehensive and high-quality product range of active and passive components for Ethernet communications.



The basic requirements of these industrial markets are high reliability, availability and safeguarding against failure. These are met by extremely high MTBF times of our network components. Using Weidmüller's high-quality **STEADYTEC**® connector system means that maximum reliability and simple operation is ensured.

Indeed, Weidmüller's network components create a complete communications infrastructure for industrial applications in machine construction, process and plant engineering and energy.

Automotive

Robust and secure from the control layer to the robot



Car manufacturers in AIDA (the German car manufacturers' automation initiative) are the driver behind the use of Industrial Ethernet in the manufacturing sector, as they clearly prefer the use of PROFINET for communication between machines and equipment parts. To make the most savings in modern communications structures, Industrial Ethernet in the automotive industry is homogeneous, from corporate management level down to production.

New production plants in North American car production are also being exclusively automated using Industrial Ethernet. Here the real-time Ethernet protocol EtherNet/IP is used. This, in the same way as PROFINET and other protocols, means there are different requirements for the connector systems used and the active network devices.

Extremely harsh environmental conditions – such as may be found where industrial robotics are used, for example – place high requirements on the components used. Cabling needs to be torsion resistant and there are increased EMC demands placed on plug-in connectors and active devices. For these application fields, Weidmüller offers a complete product range consisting of copper and fibre-optic connectors and passive hand-tools that are specifically designed for the requirements of cabling robotic systems.

The use of active devices with powerful redundancy mechanisms is needed to prevent network failures. Weidmüller's managed switches meet these requirements with their particularly fast recovery time of under 20 ms when an error occurs.

General machine construction

High-performance solutions, simply integrated



Important aspects of communications in machinery and device construction are networking machine segments and device parts and connecting them to the higher-level office network. Many serial devices are connected to the Ethernet infrastructure to protect investments and because of the various different communication protocols in use. Weidmüller offers active components for this which convert the protocols. By simply integrating devices with serial interfaces, you get protection for your investments in existing automation components.

The volume of data in networks is steadily rising with the applications used, for example with camera-based quality control. Weidmüller easily meets these increased demands with its product range of high-performance Gigabit switches and plug-in connectors capable of 10 Gigabit transfer.

The extensive plug-in connector range also meets the higher demands in terms of EMC as well as shock, vibration and temperature resistance and facilitates easy on-site assembly.

Dragline cable-compatible connection cables from Weidmüller are used on moving parts of complex machines. Hard to reach areas can be covered using the wireless modules that are available.

Machinery - in detail

Your robots are always in action

We enable them to let you know what they are up to

Let's connect.

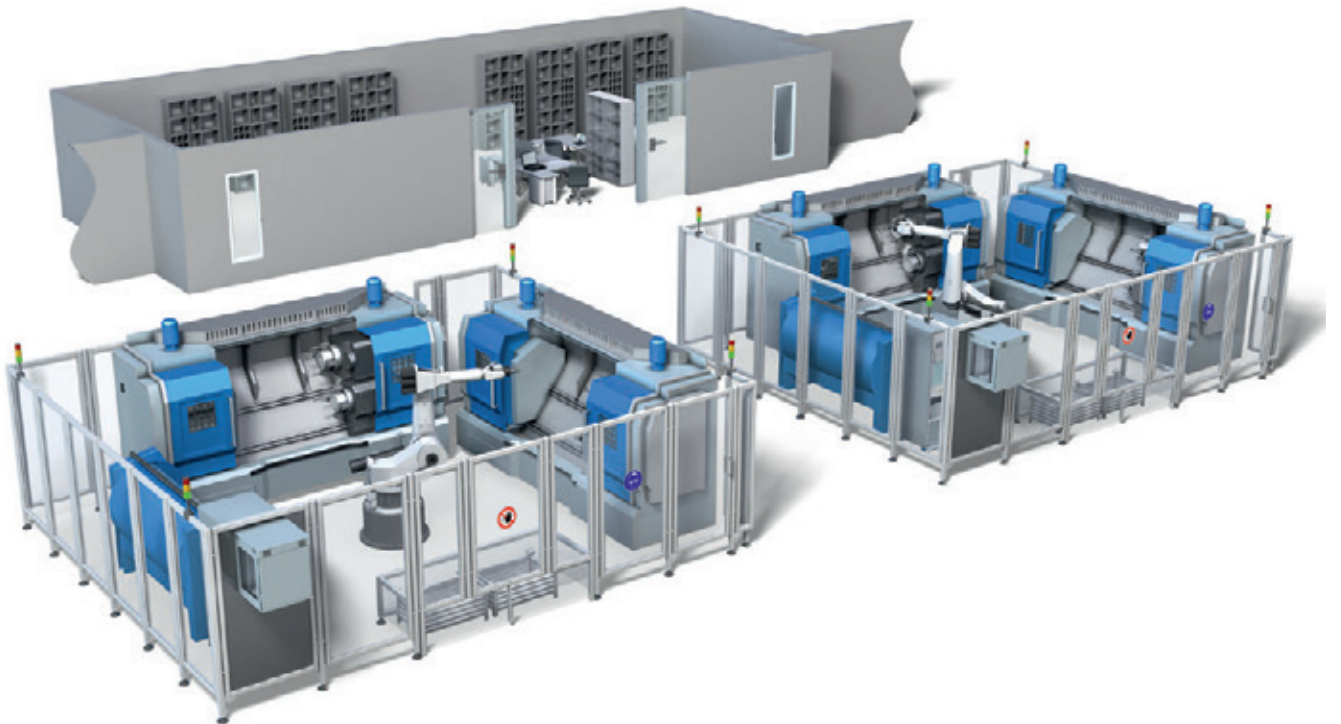

You require a seamless flow of information to optimise the output and efficiency of your production cells – from networking the communication between machine segments, to the exchange of information with higher-level office networks. In this way you can constantly monitor the activities of your robots.

To provide you with seamless communication without media disruption, we offer you a comprehensive Industrial Ethernet product portfolio from field to control level – with significant advantages. Thanks to the innovative **STEADYTEC**[®] technology used, our plug-in connectors create the basis for reliable and standardised connection solutions in data communication, both in the office and in harsh production environments. With functions such as high-speed ring

redundancy or redundant power supply, our active Industrial Ethernet components guarantee uninterrupted operation of your production network.

Extensive network management functions effectively handle your data traffic. Our Power-over-Ethernet switches supply the operating voltage to the cameras that monitor your manufacturing processes, in parallel to data traffic.

With these and many other functions, our multifaceted Industrial Ethernet portfolio supports your communication at control, infrastructure and machine levels. This means that channels of communication with your robots are always open.

Let's connect.

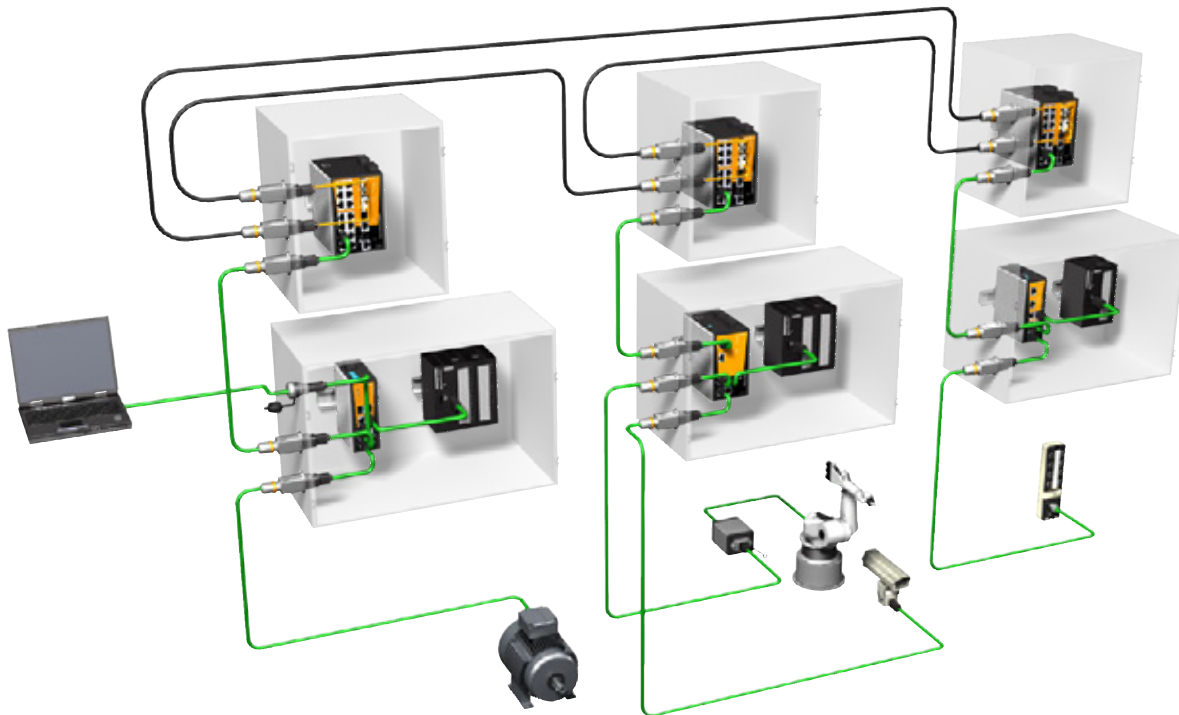

Plug-in connectors and cabling system

- IEC-standardised connector, in variants 1, 4, 5, 6 and 14
- All in Cat. 6_A and with **STEADYTEC**[®] technology
- Cables pre-assembled and sold by the metre
- Copper and fibre-optic cables
- IP 20 and IP 67
- All relevant Industrial Ethernet industrial connections
- Comprehensive range of accessories



Active Industrial Ethernet components

- Unmanaged switches (Fast Ethernet, Gigabit Ethernet)
- Managed switches (Fast Ethernet, Gigabit Ethernet)
- Power-over-Ethernet switches (unmanaged, managed)
- Media converters (copper, fibre-optic cables)
- Serial/Ethernet converters
- Modbus TCP/RTU Gateway
- Industrial wireless components
- Industrial security routers

Process

Secure communication, even over large distances

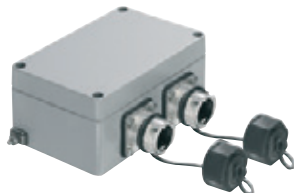
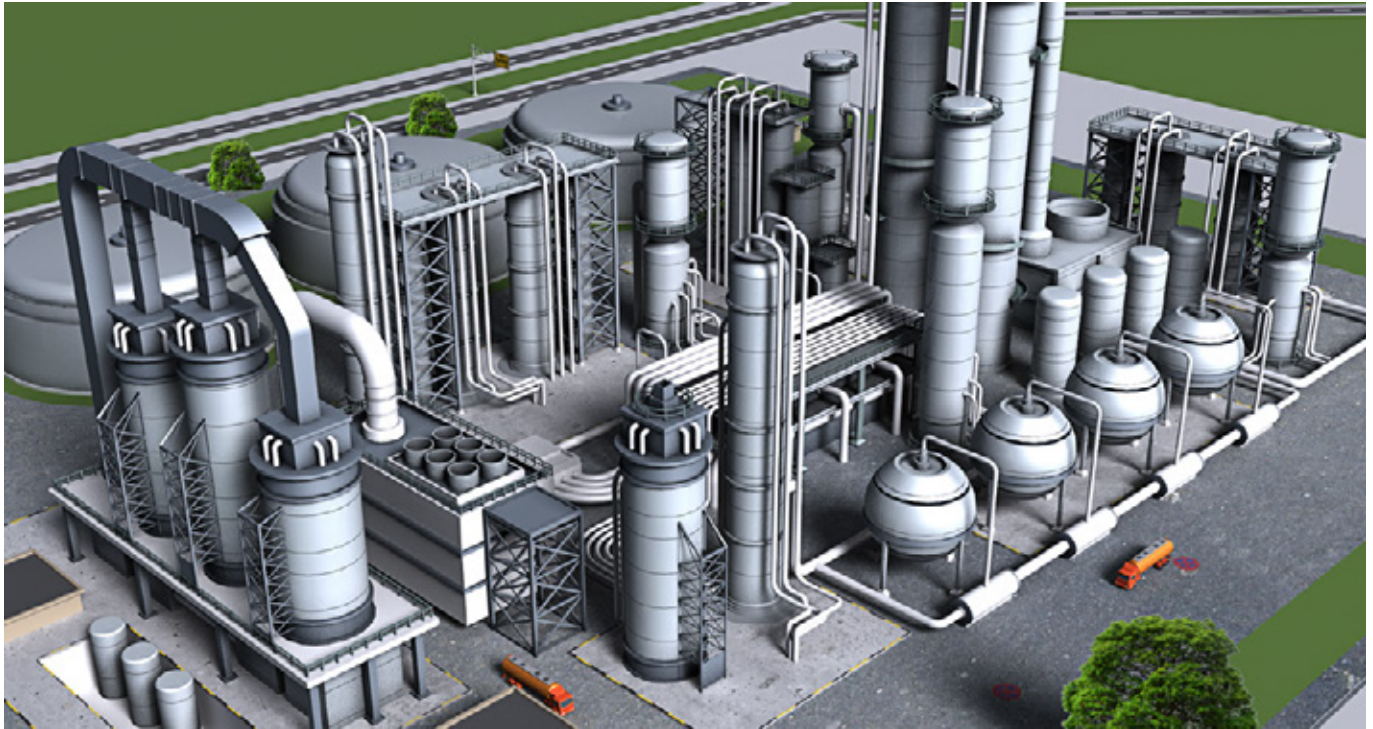

Weidmüller's network components for the process industry allow their use in explosion hazard areas with their certification - Class 1 Div. 2 and ATEX. The active components have high fault-tolerance and ensure high system availability with redundancy mechanisms like trunking and ring-redundancy as well as RSTP.

Long distances can be bridged using fibre-optic media in large process plants. There are requirements like high protection class when you use components in the field. The harsh environments in process plants are characterised by high temperature variations, vibrations, rain and dust, as well as electromagnetic influences. Weidmüller's active and passive Ethernet components are well able to withstand these influences.

It is particularly important to make sure the communication between various areas of the plant is secure. Weidmüller's Ethernet switches support network management and security functions like IGMP Snooping, IEEE 802.1X, QoS and VLAN.

This means that the devices form a secure and efficient communications bridge to the office, from the plant to the controller and then out to the wider IT network.

Active components

Introduction

Introduction - Active components	Introduction - Active components	A.2
	Switches - quick-finder	A.6

Active components

Solutions for global industrial use

Ethernet technology is an established standard in office communication and has existed for many years. Without it, effective communications between equipment such as PCs, printers, data servers, etc. would not be possible.

In recent years this technology has been expanded under the term Industrial Ethernet and implemented in automation systems. The common goal of both manufacturer and user is to make the networking of automation system components easier and more effective. To make process data and diagnostic functions device-independent when exchanged between network participants, all equipment in a plant should be linked with just one bus technology.

Industrial applications, however, differ significantly from office applications. In addition, there are normally much higher demands placed on the communication devices in the industrial setting. These include:

- Installation conditions
- Environmental conditions
- Protocols
- Approvals

Weidmüller's Industrial Ethernet components meet all of these requirements as they have the properties listed below:

- Reliable (redundant) power supply for uninterrupted network operation
- Resistance to extreme temperatures
- Immune to electromagnetically caused malfunctions
- Insensitive to vibration, shock and corrosive environments
- Conformity with various certification standards
- Longevity

These rugged devices can therefore be used world-wide in different industries and applications.



Stable and versatile power supply inputs for industrial applications

The redundant voltage inputs provide reliable functionality of the whole system. If a power supply fails, the redundant power source takes over the energy supply. All of Weidmüller's Industrial Ethernet components have a wide input voltage range of at least 12 to 48 V DC (Basic Line switches 9.6 to 60 V DC). They can also work with large fluctuations in voltage. For instance, with a rated 48 V DC input, a fluctuation of +20 % is acceptable and yet, in one of 12 V DC, a voltage drop of up to 20 % presents no problems for the attached devices.

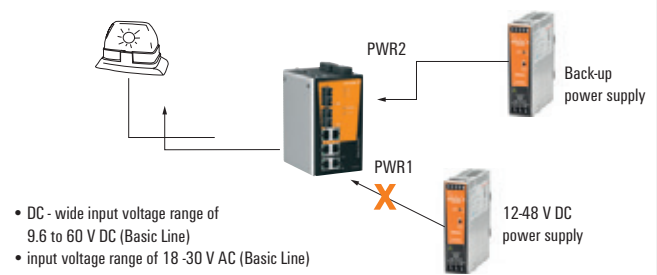

Suitable for use in extreme temperature environments

Industrial environments often experience extreme temperature conditions. This means that devices are needed which can operate flawlessly with the vast temperature fluctuations. All of our Industrial Ethernet components undergo a burn-in test over several hours to ensure they function properly at the guaranteed temperature ranges (e.g. -40 °C to +75 °C).

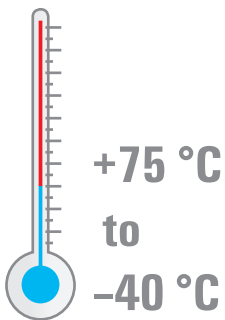

Outstanding immunity to electromagnetic interference

The robust design of Weidmüller's Industrial Ethernet components also includes excellent electromagnetic compatibility and fully complies with the requirements and standards.

Certified to industry standards

An extensive range of certifications confirm the reliability of Weidmüller's Industrial Ethernet components

- UL 508 and UL 60950-1
- Class I, Division 2 / ATEX Zone 2 for safe use in hazardous areas
- DNV/GL approval for use in maritime settings



Durability and reliability

- Many of the Weidmüller Ethernet components have relay outputs. These can be used for alarm signal notification (e.g. power failures or port problems). This means that, in emergencies, it is possible to react quickly to any failures.
- Weidmüller's unmanaged switches are protected from receiving too many broadcast packets. The switches discard broadcast or multicast packets if they exceed a threshold level in a given time. They then receive further broadcast and multicast packets after a given time has past, until the threshold level is reached again.
- All Weidmüller active Industrial Ethernet components are designed for a long service life and this can be seen from the high MTBF value. Weidmüller also guarantees its Industrial Ethernet components for a period of five years.

The ideal solution, whatever your needs

Our Basic, Value and Premium Line product ranges

Basic Line



Weidmüller's Basic Line series consists of unmanaged Plug & Play switches in a rugged IP 30 rated aluminium housing. The devices are available with Fast Ethernet and Gigabit Ethernet and provide an economical solution for Industrial Ethernet networks. One model is equipped with Fast Ethernet and Power-over-Ethernet ports. All devices have been developed for applications in harsh industrial environments and have international approvals such as CE, cULus, Class I Div. 2 / Atex and DNV / GL and are thus internationally available for different applications.

- Plug & Play switches in a rugged aluminium housing (IP 30)
- Compact design
- Cost efficient entry-level switches
- Fast Ethernet variants with 5 and 8 Ports
- Versions with copper or fibre-optic interface (multimode and single-mode)
- 5 port Full-Gigabit Plug & Play Switch
- Power-over-Ethernet switch with 6 Fast Ethernet ports, thereof 4 PoE+ ports
- Approvals: cULus, Class I Div. 2 / Atex, DNV / GL

Value Line



Weidmüller's Value Line series consists of unmanaged and managed switches in a high quality IP 30 rated metal housing. The devices are available with Fast Ethernet and Gigabit Ethernet ports. Value Line managed switches support a variety of useful management functions, such as fast ring redundancy, VLAN, QoS, RMON, bandwidth management, port mirroring and warning by email message or relay. The ring redundancy can be set up easily using the web-based management interface, or with the DIP switches located on the top panel of the switches.

- Unmanaged Plug & Play switches in a high quality metal housing (IP 30)
- Price-sensitive mid-range class
- Managed switches for entry into configurable network infrastructure
- Unmanaged 8 port Full-Gigabit switches
- Approvals: cULus, Class I Div. 2 / Atex, DNV / GL

Premium Line



Weidmüller's Premium Line series completes the switch range for the high-end sector and is particularly suitable for complex network solutions with high traffic levels. The devices are available in different versions, ie. number of ports, transmission rate (Fast and Gigabit Ethernet) and the Type of connection (copper and fibre-optic).

With their advanced ring redundancy technology (recovery time ≤ 20 ms), these devices increase the reliability and availability of your industrial network. The option to use SFP transceivers offer a high degree of flexibility and the Gigabit variants also allow their use in networks with high traffic loads.

- Managed Fast Ethernet variants in a high quality metal housing (IP 30)
- Managed Power-over-Ethernet switch with 6 Fast Ethernet ports, thereof 4 PoE+ ports
- Variants with 10 or 18 ports and Gigabit uplink ports
- Full-Gigabit switch with 9 ports
- Supports all standard protocols in TCP/IP-based industrial networks (e.g. EtherNet/IP, Modbus/TCP)
- Built-in redundancy mechanisms (recovery time ≤ 20 ms) for increased reliability in network ring structures
- Approvals: cULus, Class I Div. 2 / Atex, DNV / GL

Switches – quick-finder

		5					6			8		
Order No.	Type	5		4	3		2	1		8		5
	Ports RJ-45: 10/100Mbit	5		4	3		2	1		8		5
	Ports RJ-45: 10/100/1000Mbit		5			1					8	
	Ports RJ-45: 10/100Mbit (PoE+)						4	4	4			
	Ports RJ-45: 10/100/1000Mbit (PoE+)				4	4						
	Ports M12: 10/100Mbit	5										
	Ports SC/ST-LWL: 100Mbit			1	2			1	2			3
	Ports SFP-LC: 100/1000Mbit											
	Ports SFP-LC: 1000Mbit						1					
Industrial Ethernet Switches												
1504410000	IE-SW-IP67-5M12	●										
1504420000	IE-SW-IP67T-5M12	●										
1240840000	IE-SW-BL05-5TX	●										
1240850000	IE-SW-BL05T-5TX	●										
1241250000	IE-SW-BL05-5GT		●									
1286850000	IE-SW-BL05T-5GT		●									
1504320000	IE-SW-BL05-1GT-4GTPoE					●						
1504340000	IE-SW-BL05T-1GT-4GTPoE					●						
1504360000	IE-SW-BL05-1GS-4GTPoE								●			
1504380000	IE-SW-BL05T-1GS-4GTPoE								●			
1240870000	IE-SW-BL05-4TX-1SCS			●								
1286530000	IE-SW-BL05T-4TX-1SCS			●								
1240880000	IE-SW-BL05-4TX-1ST			●								
1286540000	IE-SW-BL05T-4TX-1ST			●								
1240890000	IE-SW-BL05-4TX-1SC			●								
1286550000	IE-SW-BL05T-4TX-1SC			●								
1241380000	IE-SW-BL06-2TX-4PoE						●					
1286920000	IE-SW-BL06T-2TX-4PoE						●					
1504210000	IE-SW-BL06-4PoE-2SC									●		
1504220000	IE-SW-BL06T-4PoE-2SC									●		
1504230000	IE-SW-BL06-4PoE-2ST									●		
1504240000	IE-SW-BL06T-4PoE-2ST									●		
1504250000	IE-SW-BL06-1TX-4PoE-1SC							●				
1504260000	IE-SW-BL06T-1TX-4PoE-1SC							●				
1504270000	IE-SW-BL06-1TX-4PoE-1ST							●				
1504290000	IE-SW-BL06T-1TX-4PoE-1ST							●				
1240900000	IE-SW-BL08-8TX										●	
1286560000	IE-SW-BL08T-8TX										●	
1240910000	IE-SW-BL08-6TX-2SC											
1240920000	IE-SW-BL08T-6TX-2SC											
1240930000	IE-SW-BL08-6TX-2ST											
1286570000	IE-SW-BL08T-6TX-2ST											
1412070000	IE-SW-BL08-7TX-1SC											
1412080000	IE-SW-BL08T-7TX-1SC											
1412090000	IE-SW-BL08-7TX-1ST											

a) Of which 2 ports are designed as combo-ports. Can be used as 10/100/1000BaseT(X) or 100/1000BaseSFP ports as required
 b) Designed as combo-ports. Can be used as 10/100/1000BaseT(X) or 100/1000BaseSFP ports as required
 c) Of which 5 ports designed as combo-ports. Can be used as 10/100/1000BaseT(X) or 100/1000BaseSFP ports as required
 d) Designed as combo-ports. Can be used as 10/100/1000BaseT(X) or 1000BaseSFP ports as required

Switches – quick-finder

Ports total		5					6			8			
Ports RJ-45: 10/100Mbit	5			4	3			2	1		8		5
Ports RJ-45: 10/100/1000Mbit			5			1						8	
Ports RJ-45: 10/100Mbit (PoE+)								4	4	4			
Ports RJ-45: 10/100/1000Mbit (PoE+)						4	4						
Ports M12: 10/100Mbit		5											
Ports SC/ST-LWL: 100Mbit				1	2				1	2			3
Ports SFP-LC: 100/1000Mbit													
Ports SFP-LC: 1000Mbit							1						
Order No.	Type												
Industrial Ethernet Switches													
1412100000	IE-SW-BL08T-7TX-1ST												
1240950000	IE-SW-BL08-7TX-1SCS												
1286580000	IE-SW-BL08T-7TX-1SCS												
1412110000	IE-SW-BL08-6TX-2SCS												
1412120000	IE-SW-BL08T-6TX-2SCS												
1241270000	IE-SW-VL08-8GT												
1286860000	IE-SW-VL08T-8GT												
1241280000	IE-SW-VL08-6GT-2GS												
1286870000	IE-SW-VL08T-6GT-2GS												
1240980000	IE-SW-VL09T-6TX-3SC												
1241000000	IE-SW-VL16-16TX												
1286590000	IE-SW-VL16T-16TX												
1241030000	IE-SW-VL16-14TX-2SC												
1286610000	IE-SW-VL16T-14TX-2SC												
1241050000	IE-SW-VL16-14TX-2ST												
1286620000	IE-SW-VL16T-14TX-2ST												
1504280000	IE-SW-VL05M-5TX												
1504310000	IE-SW-VL05MT-5TX												
1504330000	IE-SW-VL05M-3TX-2SC												
1504350000	IE-SW-VL05MT-3TX-2SC												
1504370000	IE-SW-VL05M-3TX-2ST												
1504390000	IE-SW-VL05MT-3TX-2ST												
1240940000	IE-SW-VL08MT-8TX												
1240970000	IE-SW-VL08MT-5TX-3SC												
1345240000	IE-SW-VL08MT-5TX-1SC-2SCS												
1344770000	IE-SW-VL08MT-6TX-2SC												
1240990000	IE-SW-VL08MT-6TX-2ST												
1241020000	IE-SW-VL08MT-6TX-2SCS												
1241390000	IE-SW-PL06M-2TX-4PoE												
1286910000	IE-SW-PL06MT-2TX-4PoE												
1241040000	IE-SW-PL08M-8TX												
1286780000	IE-SW-PL08MT-8TX												
1241070000	IE-SW-PL08M-6TX-2SC												
1286790000	IE-SW-PL08MT-6TX-2SC												
1241080000	IE-SW-PL08M-6TX-2ST												

- a) Of which 2 ports are designed as combo-ports. Can be used as 10/100/1000BaseT(X) or 100/1000BaseSFP ports as required
b) Designed as combo-ports. Can be used as 10/100/1000BaseT(X) or 100/1000BaseSFP ports as required
c) Of which 5 ports designed as combo-ports. Can be used as 10/100/1000BaseT(X) or 100/1000BaseSFP ports as required
d) Designed as combo-ports. Can be used as 10/100/1000BaseT(X) or 1000BaseSFP ports as required

Switches – quick-finder

Ports total		5					6			8			
Ports RJ-45: 10/100Mbit	5			4	3			2	1		8		5
Ports RJ-45: 10/100/1000Mbit			5			1						8	
Ports RJ-45: 10/100Mbit (PoE+)								4	4	4			
Ports RJ-45: 10/100/1000Mbit (PoE+)					4	4							
Ports M12: 10/100Mbit		5											
Ports SC/ST-LWL: 100Mbit				1	2				1	2			3
Ports SFP-LC: 100/1000Mbit													
Ports SFP-LC: 1000Mbit							1						
Order No.	Type												
Industrial Ethernet Switches													
1286800000	IE-SW-PL08MT-6TX-2ST												
1241090000	IE-SW-PL08M-6TX-2SCS												
1286810000	IE-SW-PL08MT-6TX-2SCS												
1241100000	IE-SW-PL16M-16TX												
1286820000	IE-SW-PL16MT-16TX												
1241120000	IE-SW-PL16M-14TX-2SC												
1286830000	IE-SW-PL16MT-14TX-2SC												
1241130000	IE-SW-PL16M-14TX-2ST												
1286840000	IE-SW-PL16MT-14TX-2ST												
1241290000	IE-SW-PL10M-3GT-7TX												
1286930000	IE-SW-PL10MT-3GT-7TX												
1241300000	IE-SW-PL10M-1GT-2GS-7TX												
1286940000	IE-SW-PL10MT-1GT-2GS-7TX												
1241320000	IE-SW-PL18M-2GC-16TX												
1286970000	IE-SW-PL18MT-2GC-16TX												
1241330000	IE-SW-PL18M-2GC-14TX2SC												
1286990000	IE-SW-PL18MT-2GC-14TX2SC												
1241340000	IE-SW-PL18M-2GC-14TX2ST												
1287000000	IE-SW-PL18MT-2GC-14TX2ST												
1241350000	IE-SW-PL18M-2GC-14TX2SCS												
1287010000	IE-SW-PL18MT-2GC-14TX2SCS												
1241370000	IE-SW-PL09M-5GC-4GT												
1287020000	IE-SW-PL09MT-5GC-4GT												

- a) Of which 2 ports are designed as combo-ports. Can be used as 10/100/1000BaseT(X) or 100/1000BaseSFP ports as required
b) Designed as combo-ports. Can be used as 10/100/1000BaseT(X) or 100/1000BaseSFP ports as required
c) Of which 5 ports designed as combo-ports. Can be used as 10/100/1000BaseT(X) or 100/1000BaseSFP ports as required
d) Designed as combo-ports. Can be used as 10/100/1000BaseT(X) or 1000BaseSFP ports as required

Switches – quick-finder

Industrial Ethernet Switches

Overview

Industrial Ethernet Switches	Unmanaged Switches	B.2
	Unmanaged Switches Fast Ethernet	B.3
	Unmanaged Switches Gigabit Ethernet	B.6
	Managed Switches introduction	B.8
	Managed Switches Fast Ethernet	B.13
	Managed Switches Gigabit Ethernet	B.16
	Power over Ethernet Switches	B.20
	Unmanaged Switches Fast Ethernet - Power over Ethernet	B.21
	Unmanaged Switches Gigabit Ethernet - Power over Ethernet	B.22
	Managed Switches Fast Ethernet - Power over Ethernet	B.23

Unmanaged Switches

Adaptable and universal

Switches are the basic coupling elements in Ethernet networks. They connect the Ethernet participants together. In an Ethernet network the communication basically originates from the participants. The switches connect the participants together and enable the communication. Unmanaged switches are the simplest active network component. They do not need to be configured and are therefore very flexible. They use the basic standard protocols, such as auto-negotiation, auto-crossing, and flow-control and can automatically adjust to the different transmission speeds or connector wiring.

Unmanaged switches are protocol transparent. Each port on the switch creates an individual collision domain. The use of twisted-pair cabling with an RJ45 interface or fibre-optic cable based on the IEEE 802.3 specification interfaces are supported by all Weidmüller switches.



Unmanaged Fast Ethernet Switches

- 10/100BaseT(X) (RJ45 connector), 100BaseFX (multi/singlemode, SC or ST connector)
- Redundant dual 12/24/48 V DC, 18 to 30 V AC power inputs
- IP 30 aluminum housing
- Rugged hardware design well suited for hazardous locations (Class I Div. 2 /ATEX) and maritime environments (DNV/GL)
- -40 °C to 75 °C operating temperature range (T models)

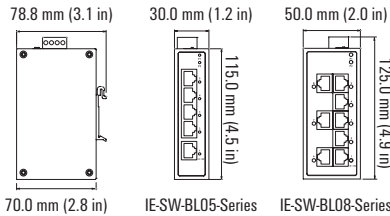

Technical data

Technology	
Standards	IEEE 802.3 for 10BaseT IEEE 802.3u for 100BaseT (X) and 100BaseFX IEEE 802.3x for Flow Control
Processing Type	Store and Forward
Flow Control	IEEE 802.3x flow control, back pressure flow control
Switch Properties	
MAC Table Size	1 K
Packet Buffer Size	512 KBit
Interface	
Fibre Ports	100BaseFX ports (SC/ST connector, multimode, singlemode)
RJ45 Ports	10/100BaseT(X) auto negotiation speed, Full/Half duplex mode, and auto MDI/MDI-X connection
DIP Switches	Enable/Disable broadcast storm protection
LED Indicators	Power, 10/100M (TP port), 100M (fibre port)
Optical Fibre	
	100BaseFX
	multimode
	singlemode
Wavelength	1300 nm
Max. Transmit power	-10 dBm
Min. Transmit power	-20 dBm
RX Sensitivity	-32 dBm
Link Budget	12 dB
Typical Distance	5 km (50/125 µm multimode cable) 4 km (62.5/125 µm multimode cable)
Saturation	-6 dBm
Power Requirements	
Input Voltage	12/24/48 V DC (9.6 to 60 V DC), 18 to 30 V AC (47 to 63 Hz), redundant dual inputs
Input Current	IE SW BL05 5TX: 0.1 A @ 24 V IE SW BL05 1SC/1ST/1SCS: 0.11 A @ 24 V IE SW BL08 8TX: 0.13 A @ 24 V IE SW BL08 2SC/2ST/2SCS: 0.22 A @ 24 V IE SW BL08 1SC/1ST/1SCS: 0.17 A @ 24 V
Overload Current Protection	1.1 A
Connection	1 removable 4-contact terminal block
Reverse Polarity Protection	Present
Physical Characteristics	
Housing	Aluminum, IP 30 protection
Dimensions (W x H x D)	IE-SW-BL05-Series: 30 x 115 x 70 mm (1.18 x 4.52 x 2.76 in) IE-SW-BL08-Series: 50 x 115 x 70 mm (1.96 x 4.52 x 2.76 in)
Weight	IE-SW-BL05-5TX: 175 g IE-SW-BL08-8TX: 275 g
Installation	DIN rail, wall (with optional mounting kit)
Environmental Limits	
Operating Temperature	Standard Models: -10 to 60 °C (14 to 140 °F) Wide Temp. Models: -40 to 75 °C (-40 to 167 °F)
Storage Temperature	-40 to 85 °C (-40 to 185 °F)
Ambient Relative Humidity	5 to 95 % (non-condensing)
Regulatory Approvals	
Safety	UL 508, UL 60950-1

Regulatory Approvals			
Hazardous Location	UL/cUL Class I, Division 2, Groups A, B, C and D; ATEX Zone 2 Ex nA IIC T4 Gc		
EMI	FCC Part 15, CISPR (EN55022) class A		
EMC	EN61000-4-2 (ESD), level 3; EN61000-4-3 (RS), level 3; EN61000-4-4 (EFT), level 3; EN61000-4-5 (Surge), level 3; EN61000-4-6 (CS), level 3; EN61000-4-8; EN61000-4-11		
Maritime	DNV, GL (not for 1412110000, 1412120000, 1412070000, 1412080000, 1412090000, 1412100000)		
Shock	IEC 60068-2-27		
Freefall	IEC 60068-2-32		
Vibration	IEC 60068-2-6		
MTBF (meantime between failures)			
Time	IE-SW-BL05-Series: 3,040,784 hrs, IE-SW-BL08-Series: 2,428,212 hrs		
Database	Telcordia (Bellcore), GB		
Warranty			
Warranty Period	5 years		
Ordering Information			
Version	Model Type	Operating Temperature	Order No.
5 * RJ45	IE-SW-BL05-5TX IE-SW-BL05T-5TX	-10 to +60 °C -40 to +75 °C	1240840000 1240850000
4 * RJ45, 1 * SC-Multimode	IE-SW-BL05-4TX-1SC IE-SW-BL05T-4TX-1SC	-10 to +60 °C -40 to +75 °C	1240890000 1286550000
4 * RJ45, 1 * ST-Multimode	IE-SW-BL05-4TX-1ST IE-SW-BL05T-4TX-1ST	-10 to +60 °C -40 to +75 °C	1240880000 1286540000
4 * RJ45, 1 * SC-Singlemode	IE-SW-BL05-4TX-1SCS IE-SW-BL05T-4TX-1SCS	-10 to +60 °C -40 to +75 °C	1240870000 1286530000
8 * RJ45	IE-SW-BL08-8TX IE-SW-BL08T-8TX	-10 to +60 °C -40 to +75 °C	1240900000 1286560000
6 * RJ45, 2 * SC-Multimode	IE-SW-BL08-6TX-2SC IE-SW-BL08T-6TX-2SC	-10 to +60 °C -40 to +75 °C	1240910000 1240920000
6 * RJ45, 2 * ST-Multimode	IE-SW-BL08-6TX-2ST IE-SW-BL08T-6TX-2ST	-10 to +60 °C -40 to +75 °C	1240930000 1286570000
6 * RJ45, 2 * SC-Singlemode	IE-SW-BL08-6TX-2SCS IE-SW-BL08T-6TX-2SCS	-10 to +60 °C -40 to +75 °C	1412110000 1412120000
7 * RJ45, 1 * SC-Multimode	IE-SW-BL08-7TX-1SC IE-SW-BL08T-7TX-1SC	-10 to +60 °C -40 to +75 °C	1412070000 1412080000
7 * RJ45, 1 * ST-Multimode	IE-SW-BL08-7TX-1ST IE-SW-BL08T-7TX-1ST	-10 to +60 °C -40 to +75 °C	1412090000 1412100000
7 * RJ45, 1 * SC-Singlemode	IE-SW-BL08-7TX-1SCS IE-SW-BL08T-7TX-1SCS	-10 to +60 °C -40 to +75 °C	1240950000 1286580000
Accessories			
	Model Type		Order No.
19" Rack Mounting Kit	RM-KIT		1241440000
Wall mounting kit for IE-SW-BL05 series	IE-WALLMOUNT-KIT-30M		1504450000
Wall mounting kit for IE-SW-BL08 series	IE-WALLMOUNT-KIT-46MM		1504440000

Unmanaged Switches Fast Ethernet – Value Line

Unmanaged Fast Ethernet Switches

- Redundant dual 24 V DC power inputs
- Relay output warning for power failure and port break alarm
- Broadcast storm protection
- Transparent transmission of VLAN tagged packets
- -40 °C to 75 °C operating temperature range (T models)

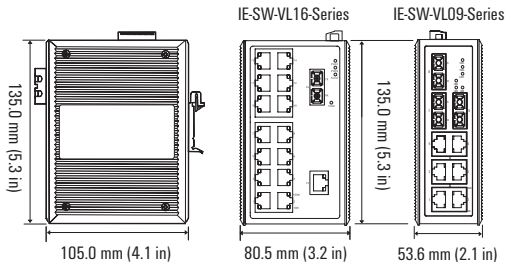

Technical data

Technology	
Standards	IEEE 802.3 for 10BaseT IEEE 802.3u for 100BaseT(X) and 100BaseFX IEEE 802.3x for Flow Control
Processing Type	Store and Forward
Flow Control	IEEE 802.3x flow control, back pressure flow control
Switch Properties	
MAC Table Size	1 K (IE-SW-VL09...Series), 4 K (IE-SW-VL16...Series)
Packet Buffer Size	512 Kbit (IE-SW-VL09...Series), 1.25 Mbit (IE-SW-VL16...Series)
Interface	
Fibre Ports	100BaseFX ports (SC/ST connector)
RJ45 Ports	10/100BaseT(X) auto negotiation speed, Full/Half duplex mode, and auto MDI/MDI-X connection
DIP Switches	Port fault alarm Enable/disable broadcast storm protection
LED Indicators	PWR1, PWR2, FAULT, 10/100M (TP port), 100M (fibre port)
Alarm Contact	1 relay output with current carrying capacity of 1 A @ 24 V DC
Optical Fibre	
	100BaseFX multimode
Wavelength	1300 nm
Max. TX	-10 dBm
Min. TX	-20 dBm
RX Sensitivity	-32 dBm
Link Budget	12 dB
Typical Distance	5 km (50/125 µm multimode cable) 4 km (62.5/125 µm multimode cable)
Saturation	-6 dBm
Power Requirements	
Input Voltage	IE-SW-VL09: 24 V DC (12 to 45 V DC), redundant dual inputs IE-SW-VL16: 12/24/48 V DC (9.6 to 60 V DC), redundant dual inputs
Input Current	IE-SW-VL09T-6TX-3SC: 0.31 A @ 24 V IE-SW-VL16-16TX: 0.27 A @ 24 V IE-SW-VL16 SC/ST: 0.44 A @ 24 V
Overload Current Protection	1.6 A
Connection	1 removable 6-pin terminal blocks
Reverse Polarity Protection	Present
Physical Characteristics	
Housing	Metal, IP 30 protection
Dimensions (W x H x D)	IE-SW-VL09...Series: 53.6 x 135 x 105 mm (2.11 x 5.31 x 4.13 in) IE-SW-VL16...Series: 80.5 x 135 x 105 mm (3.16 x 5.31 x 4.13 in)
Weight	IE-SW-VL09: 790 g IE-SW-VL16: 1140 g

Physical Characteristics	
Installation	DIN-Rail mounting
Environmental Limits	
Operating Temperature	Standard Models: 0 to 60 °C (32 to 140 °F) Wide Temp. Models: -40 to 75 °C (-40 to 167 °F)
Storage Temperature	-40 to 85 °C (-40 to 185 °F)
Ambient Relative Humidity	5 to 95 % (non-condensing)
Regulatory Approvals	
Safety	UL 508, UL 60950-1 CSA C22.2 No. 60950-1, EN60950-1
Hazardous Location	UL/cUL Class 1, Division 2, Groups A, B, C and D; ATEX Zone 2 Ex nA nC IIC T4 Gc
EMI	FCC Part 15, CISPR (EN55022) class A
EMC	EN61000-4-2 (ESD), level 3; EN61000-4-3 (RS), level 3; EN61000-4-4 (EFT), level 3; EN61000-4-5 (Surge), level 3; EN61000-4-6 (CS), level 3;
Maritime	DNV, GL
Shock	IEC 60068-2-27
Freefall	IEC 60068-2-32
Vibration	IEC 60068-2-6
MTBF (mean time between failures)	
Time	IE-SW-VL09...Series: 396,000 hrs IE-SW-VL16...Series: 257,000 hrs
Database	MIL-HDBK-217F, GB 25 °C
Warranty	
Warranty Period	5 years

Ordering Information			
Version	Model Type	Operating Temperature	Order No.
16 * RJ45	IE-SW-VL16-16TX IE-SW-VL16T-16TX	0 to +60 °C -40 to +75 °C	1241000000 1286590000
6 * RJ45, 3 * SC-Multimode	IE-SW-VL09T-6TX-3SC	-40 to +75 °C	1240980000
14 * RJ45, 2 * SC-Multimode	IE-SW-VL16-14TX-2SC IE-SW-VL16T-14TX-2SC	0 to +60 °C -40 to +75 °C	1241030000 1286610000
14 * RJ45, 2 * ST-Multimode	IE-SW-VL16-14TX-2ST IE-SW-VL16T-14TX-2ST	0 to +60 °C -40 to +75 °C	1241050000 1286620000

Accessories		
	Model Type	Order No.
19" Rack Mounting Kit	RM-KIT	1241440000
Wall mounting kit	IE-WALLMOUNT-KIT-46MM	1504440000

IP 67 unmanaged Fast Ethernet Switches

- M12 connection system and IP67 protected housing
- 10/100BaseT (X), 4-pin M12 (D-coded)
- Full/half duplex mode and auto MDI/MDI-X
- Input voltage 12 to 45 V DC, 18 to 30 V AC

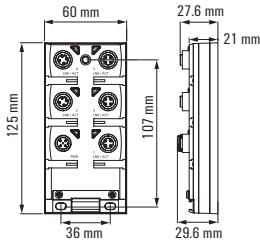

Technical data

Technology	
Standards	IEEE 802.3 for 10BaseT IEEE 802.3u for 100BaseT (X) IEEE 802.3x for Flow Control
Processing Type	Store and Forward
Flow Control	IEEE 802.3x flow control, back pressure flow control
Switch Properties	
MAC Table Size	2 K
Packet Buffer Size	384 Kbit
Interface	
M12-Ports	10/100BaseT (X) auto negotiation, full/half duplex mode and auto MDI/MDI-X connection, 4-pin, D-coded
LED Indicators	PWR, LNK/ACT
Power Requirements	
Input Voltage	24 V DC (12 to 45 V DC) 18 to 30 V AC (47 to 63 Hz)
Input Current	0,12 A @ 24 V DC 0,28 A @ 24 V AC
Overload Current Protection	1,1 A
Connection	1 x M12 socket, A-coded
Reverse Polarity Protection	Present
Physical Characteristics	
Housing	Plastic, IP 67 protection, encapsulated
Dimensions (W x H x D)	60 x 125 x 29.6 mm (2.36 x 4.92 x 1.09 Zoll)
Weight	270 g
Installation	Wall mounting, screwed
Environmental Limits	
Operating Temperature	Standard Models: -25 to 60 °C (-13 to 140 °F) Wide Temp. Models: -40 to 75 °C (-40 to 167 °F)
Storage Temperature	-40 to 85 °C (-40 to 185 °F)
Ambient Relative Humidity	5 to 95 % (non-condensing)

Regulatory Approvals			
Safety	UL 508		
EMC	FCC Part 15 Subpart B Class A, EN 55022 Class A EN61000-4-2 (ESD), level 3; EN61000-4-3 (RS), surpasses level 3; EN61000-4-4 (EFT), level 3; EN61000-4-5 (Surge), level 3; EN61000-4-6 (CS), level 2; EN61000-4-8; EN61000-4-11		
Shock	IEC 60068-2-27		
Freefall	IEC 60068-2-32		
Vibration	IEC 60068-2-6		
MTBF (mean time between failures)			
Time	370.224 hrs		
Database	Telcordia (Bellcore), GB		
Warranty			
Warranty Period	5 years		
Ordering data			
Version	Model Type	Operating Temperature	Order No.
5 * M12 10/100BaseT(X)	IE-SW-IP67-5M12	-25 to +60 °C	1504410000
	IE-SW-IP67T-5M12	-40 to +75 °C	1504420000

Unmanaged Switches Gigabit Ethernet – Basic/Value Line

Unmanaged Gigabit Ethernet Switches

- Full Gigabit Ethernet on all ports
- Variants with slots for Gigabit SFP transceivers
- Redundant dual 12/24/48 V DC power inputs
- Relay output warning for power failure and port break alarm
- Broadcast storm protection
- Supports jumbo frame transmission (up to 9.6 KB)

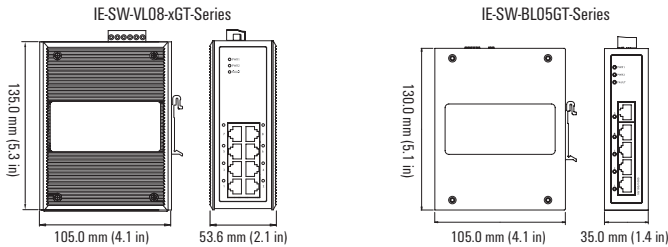

Technical data

Technology	
Standards	IEEE 802.3 for 10BaseT IEEE 802.3u for 100BaseT(X) and 100BaseFX IEEE 802.3ab for 1000BaseT(X) IEEE 802.3z for 1000BaseX IEEE 802.3x for Flow Control
Processing Type	Store and Forward
Flow Control	IEEE 802.3x flow control, back pressure flow control
Switch Properties	
MAC Table Size	8 K
Packet Buffer Size	1088 KBit (IE-SW-BL05-5GT), 1408 KBit (IE-SW-VL08-xGT)
Jumbo frame support	up to 9.6 KB
Interface	
Fibre Ports	100/1000BaseSFP slot (only IE-SW-VL08-6GT-2GS)
RJ45 Ports	10/100/1000BaseT(X) auto negotiation speed, Full/Half duplex mode, and auto MDI/MDI-X connection
DIP Switches	Port fault alarm Enable/disable broadcast storm protection Enable/disable jumbo frame support
LED Indicators	PWR1, PWR2, FAULT, 10/100/1000M
Alarm Contact	1 relay output with current carrying capacity of 1 A @ 24 V DC
Power Requirements	
Input Voltage	12/24/48 V DC (9.6 to 60 V DC), redundant dual inputs
Input Current	IE-SW-BL05-5GT: 0.20 A @ 24 V IE-SW-VL08-8GT: 0.32 A @ 24 V IE-SW-VL08-6GT-2GS: 0.34 A @ 24 V
Connection	1 removable 6-contact terminal block
Reverse Polarity Protection	Present
Physical Characteristics	
Housing	Metal, IP 30 protection
Dimensions (W x H x D)	IE-SW-BL05-5GT: 35 x 130 x 105 mm (1.37 x 5.12 x 4.13 in) IE-SW-VL08-xGT: 53.6 x 135 x 105 mm (2.11 x 5.31 x 4.13 in)
Weight	IE-SW-BL05-5GT: 290 g IE-SW-VL08-8GT 630 g
Installation	DIN-Rail mounting
Environmental Limits	
Operating Temperature	Standard Models: 0 to 60 °C (32 to 140 °F) Wide Temp. Models: -40 to 75 °C (-40 to 167 °F) (on request)
Storage Temperature	-40 to 85 °C (-40 to 185 °F)
Ambient Relative Humidity	5 to 95 % (non-condensing)
Regulatory Approvals	
Safety	UL 508
Hazardous Location	UL/cUL Class I, Division 2, Groups A, B, C, and D; ATEX Zone 2 Ex nA nC IIC T4 Gc
EMI	FCC Part 15, CISPR (EN55022) class A

Regulatory Approvals	
EMC	EN61000-4-2 (ESD), level 3; EN61000-4-3 (RS), level 3; EN61000-4-4 (EFT), level 3; EN61000-4-5 (Surge), level 3; EN61000-4-6 (CS), level 3
Maritime	DNV, GL
Shock	IEC 60068-2-27
Freefall	IEC 60068-2-32
Vibration	IEC 60068-2-6
MTBF (mean time between failures)	
Time	478.000 hrs (Serie IE-SW-BL05-5GT) 325.000 hrs (Serie IE-SW-VL08-xGT)
Database	Telcordia (Bellcore), GB (IE-SW-VL08-xGT series)
Warranty	
Warranty Period	5 years

Ordering Information			
Version	Model Type	Operating Temperature	Order No.
5 * RJ45 10/100/1000BaseT(X)	IE-SW-BL05-5GT	0 to 60 °C	1241250000
	IE-SW-BL05T-5GT	-40 to +75 °C	1286850000
8 * RJ45 10/100/1000BaseT(X)	IE-SW-VL08-8GT	0 to +60 °C	1241270000
	IE-SW-VL08T-8GT	-40 to +75 °C	1286860000
6 * RJ45 10/100/1000BaseT(X), 2 Combo Ports (10/100/1000 BaseT(X) or 100/1000BaseSFP)	IE-SW-VL08-6GT-2GS	0 to +60 °C	1241280000
	IE-SW-VL08T-6GT-2GS	-40 to +75 °C	1286870000

Accessories		
	Model Type	Order No.
19" Rack Mounting Kit	RM-KIT	1241440000
Wall mounting kit	IE-WALLMOUNT-KIT-46MM	1504440000

Note

The IE-SW-VL08-6GT-2GS supports up to 2x 100/1000Base SFP slots. Corresponding SFP modules for Fast/Gigabit Ethernet, see page F.8.

Managed Switches

Configurable according to requirements

B

Managed switches offer extensive control mechanisms for data distribution and bandwidth management to co-ordinate and cope with the different requirements of communication participants in an industrial network. Configuration is either web-based using a simple and intuitive user interface or via a serial console.

Powerful and reliable network redundancy

It is particularly important to have network redundancy to ensure system availability in today's Industrial Ethernet infrastructures. This is because in a highly integrated system, a connection error can lead to machine stoppage and thus to production losses. To minimise such risks in a managed Ethernet network, Weidmüller has integrated high-performance redundancy mechanisms into its managed switches. This is in addition to the RSTP/STP standard and port-trunking.

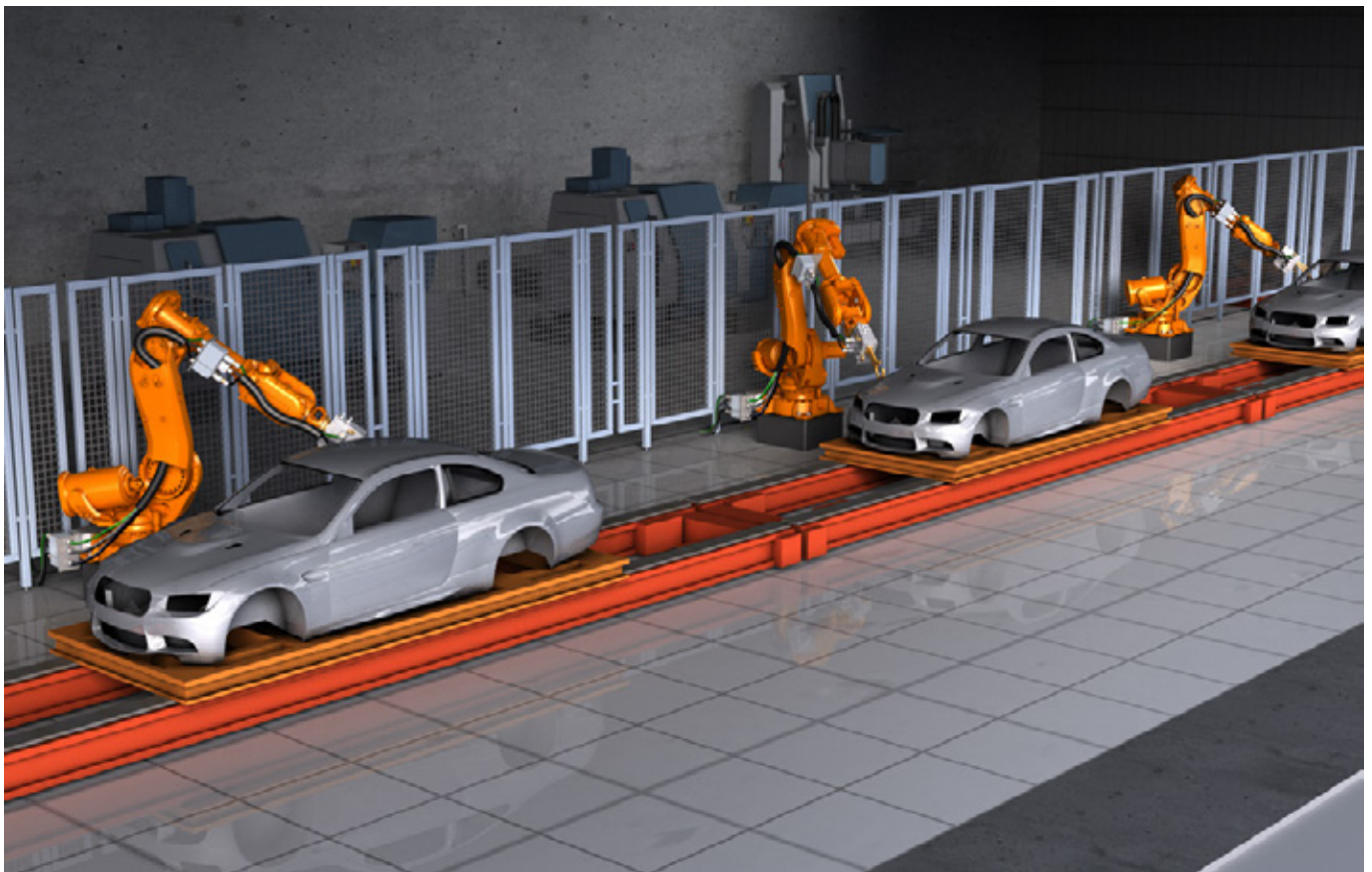

Ring redundancy

The Turbo-Ring technology integrated into Weidmüller’s switches allows you to restore a network connection in case of failure in under 20 ms, and this with up to 250 switches in a ring. Turbo-Ring offers three different topology options (Ring-Coupling, Dual-Ring and Dual-Homing) for different application requirements to ensure the maximum possible availability of industrial network applications.

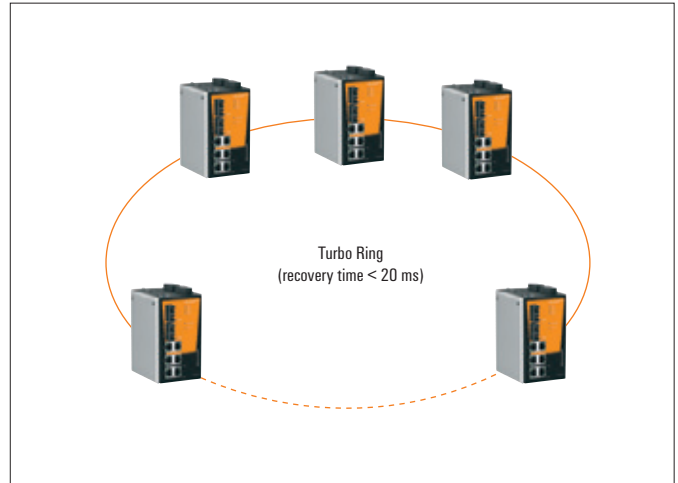

Ring-Coupling

In some applications, it is not sensible to have all equipment and devices in a single large redundant ring networked together, as some of the devices may be located in remote parts of the plant. For such structures, Ring-Coupling is ideal. It connects devices in multiple, smaller rings that are connected redundantly and directly with one another.

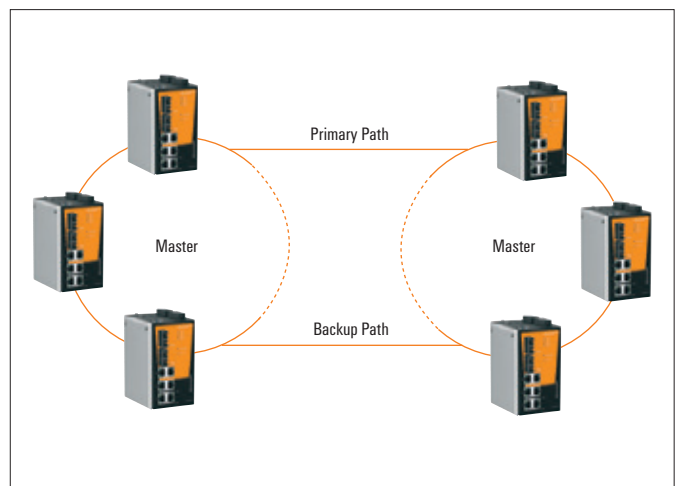

Dual-Homing

With Dual-Homing, two separate rings are connected through one managed switch via two independent connection points. The back-up connection is activated if the primary connection fails.

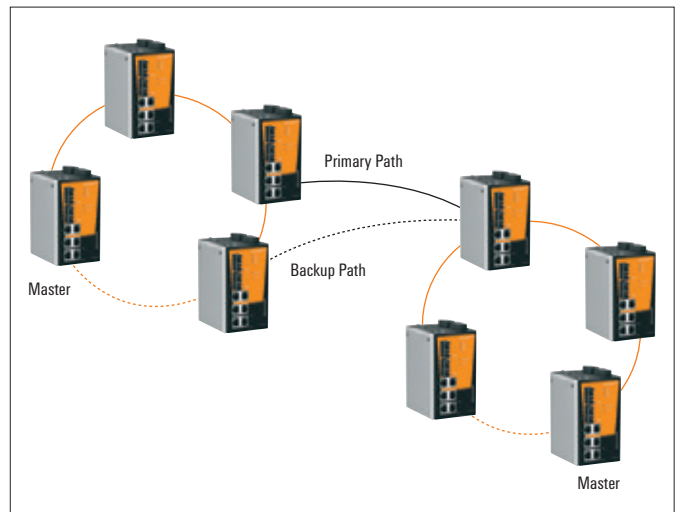

Dual-Ring

In a Dual-Ring, two neighbouring rings are connected with one another using one switch, without the need for additional ports or cabling. This configuration reduces the total number of ports and saves cabling costs, as an additional primary and back-up line is not needed.

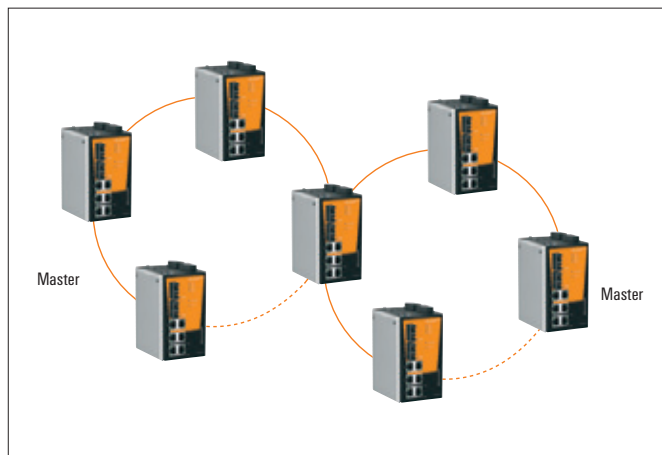

Turbo-Chain

Turbo-Chain offers the possibility of creating multiple redundant networks without the limitations of ring technology. Turbo-Chain can be simply configured by defining two end-points in a segment. This means you can connect or extend existing redundant networks. When compared with traditional ring coupling or a network re-design, Turbo-Chain is more flexible as well as being more cost efficient and it has significant savings potential when compared to the effort for network restructuring and re-cabling. In addition Turbo Chain also supports IEEE 802.1w/D RSTP and STP protocols.

- Flexible network topology
- Unlimited and simple network expansion
- Quick troubleshooting (recovery time < 20 ms)
- Cost-effective configurations

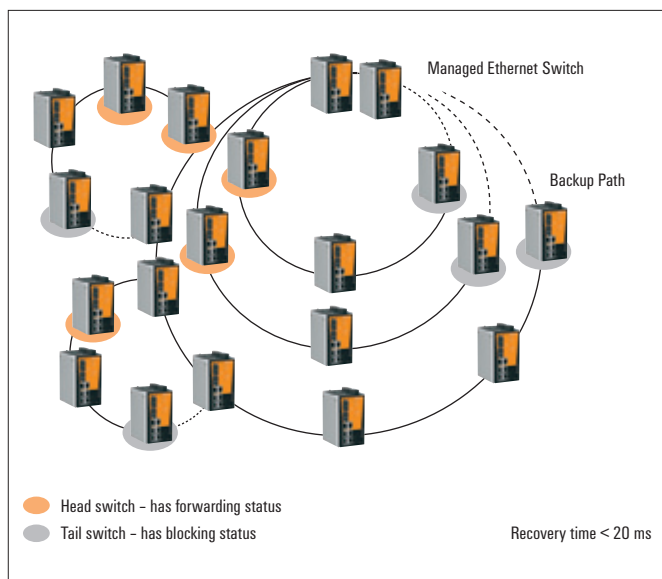

Port trunking for flexible connections

IEEE 802.3ad (LACP, Link Aggregation Control Protocol) permits flexible network connections and a redundant path for critical applications. It provides the means for a user to link via a higher bandwidth over the PremiumLine managed switches by combining more ports into a trunk group.

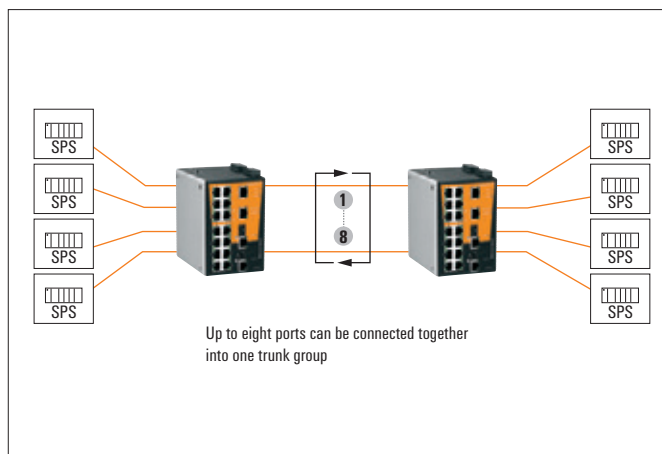

QoS supports real-time capability

Quality of Service (QoS) enables the possibility of prioritisation of data traffic in a network and ensures that important data is consistently available. Weidmüller managed switches can deal with IEEE 802.1p/1Q layer 2 CoS tags and also layer 3 TOS information. The QoS functionality of Weidmüller’s managed switches improves network performance and ensures that time-critical applications are given priority.

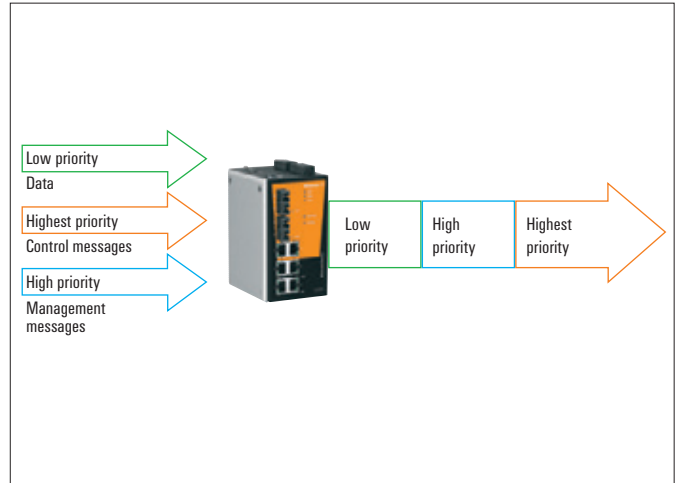

IGMP snooping and GMRP for filtering multicast data traffic

Weidmüller managed switches support GMRP (Generic Multicast Registration Protocol) and IGMP snooping. These protocols limit multicast data traffic so that it is only forwarded to the devices that actually require it. This reduces unnecessary network data traffic.

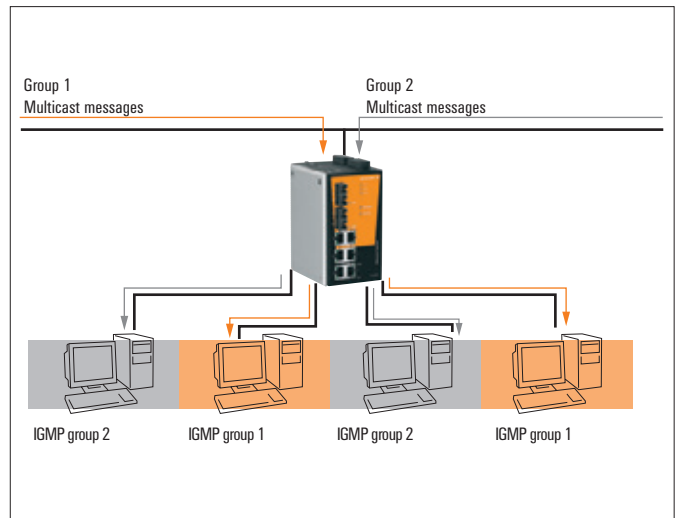

IEEE 1588 PTP - improves time synchronisation of automation devices

IEEE 1588 PTP, also known as Precision Time Protocol (PTP), was developed to synchronise real-time clocks which are located at specific nodes of a distributed system. Weidmüller managed switches with IEEE 1588 PTP are particularly suited for motion control applications where distributed clocks must be synchronised with high levels of accuracy.

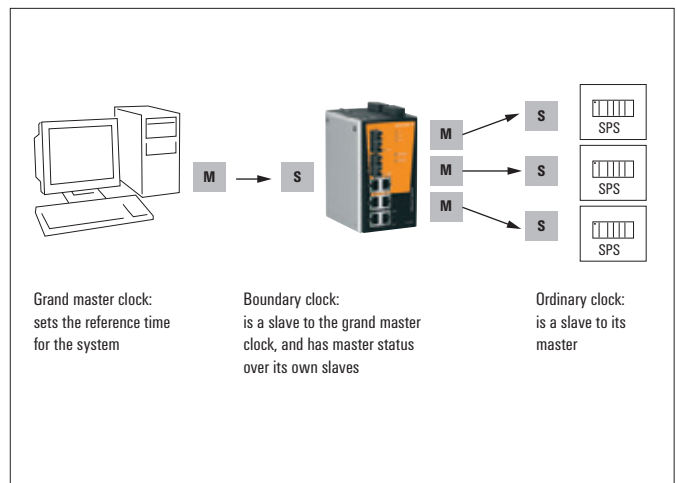

VLAN – simplifies network planning

VLAN stands for virtual LAN. It is a network structure with all the characteristics of a normal LAN, but not geographically constrained. A network can be divided into different sections using the VLAN function. It is possible, for example, to group servers or workstations together, based on their function. Data will only then be sent to Ethernet devices of a specific VLAN group. The option for isolating VLANs completely from one another serves to increase the security of data transfer and offers additional protection from unauthorised access or unauthorised data traffic.

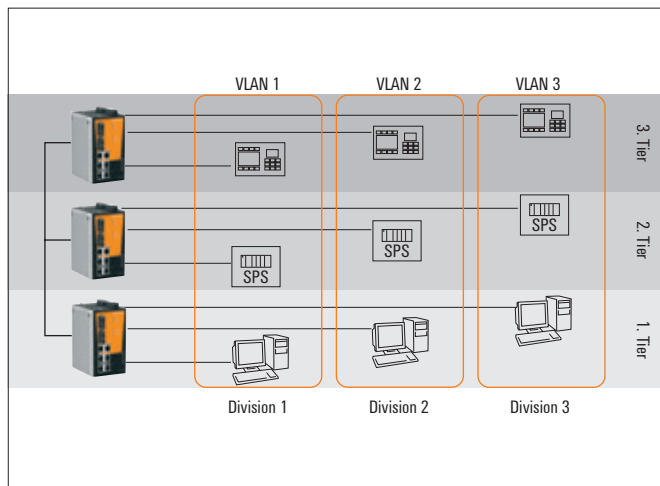

Automatic topology detection using LLDP

The Link Layer Discovery Protocol (LLDP - IEEE 802.1AB) is a data link layer protocol which publishes information about a device containing its IP address, description and functional information to its neighbouring devices over the network. All of Weidmüller’s managed switches fully support LLDP.

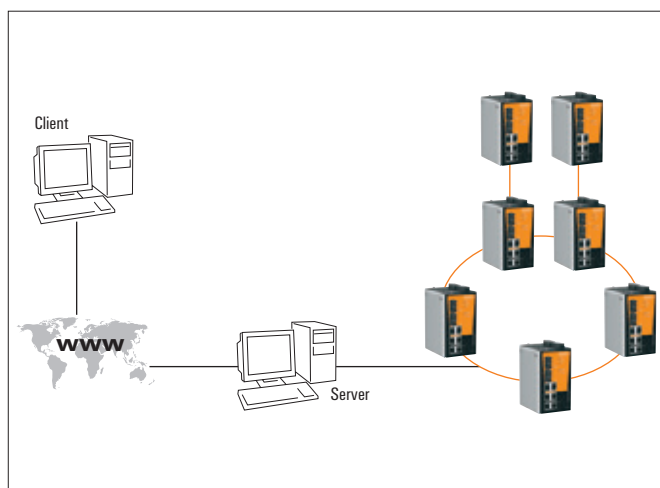

Simple browser based configuration

Weidmüller’s managed switches can be easily configured using a web browser, telnet console or the Weidmüller switch configuration utility. Further switch configurations can be saved or the firmware updated using this user-friendly tool.



5-Port Managed Entry-level Ethernet Switches

- Supports the automation protocols Modbus/TCP, PROFINET RT and EtherNet/IP
- Turbo Ring and Turbo Chain with fast recovery time (<20 ms @ 250 switches)
- IGMP snooping, QoS, port- and tag-based VLAN
- Configurable error messages via SNMP trap, e-mail or relay output
- User-friendly, web-based configuration and management

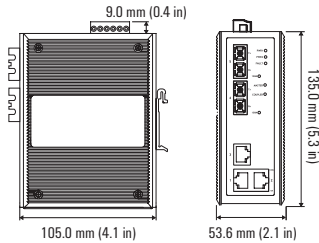

EtherNet/IP™

PROFINET®
PROFIBUS-DP/RS-485

Modbus-IDA
the architecture for distributed automation

Technical data

Standards	
IEEE 802.3 for 10BaseT ■ IEEE 802.3u for 100BaseT(X) and 100BaseFX ■ IEEE 802.3x for Flow Control ■ IEEE 802.1D-2004 for Spanning Tree Protocol ■ IEEE 802.1w for Rapid STP ■ IEEE 802.1p for Class of Service ■ IEEE 802.1Q for VLAN Tagging	
Protocols	
IGMPv1/v2 ■ GMRP ■ GVRP ■ SNMPv1/v2c/v3 ■ DHCP Server/Client ■ TFTP ■ SNMP ■ SMTP ■ RARP ■ RMON ■ HTTP ■ Telnet ■ Syslog ■ DHCP Option 66/67/82 ■ BootP ■ LLDP ■ Modbus/TCP ■ PROFINET RT (PROFINET-IO device in compliance with Conformance Class B) ■ EtherNet/IP (CIP support) ■ IPv6	
MIB	
MIB-II ■ Ethernet-like MIB ■ P-BRIDGE MIB ■ Bridge MIB ■ RSTP MIB ■ RMON MIB Group 1, 2, 3, 9 ■ Private MIB	
Flow Control	
IEEE 802.3x flow control ■ back pressure flow control	
Switch Properties	
MAC Table Size	2 K
Packet Buffer Size	1 MBit
Interface	
Fibre Ports	100BaseFX ports (SC/ST connector)
RJ45 Ports	10/100BaseT(X) auto negotiation speed, Full/Half duplex mode, and auto MDI/MDI-X connection
Console Port	RS 232 (RJ45 connector)
DIP Switches	Turbo Ring, Master, Coupler, Reserve
LED Indicators	PWR1, PWR2, FAULT, MSTR/HEAD, CPLR/TAIL, 10/100M
Alarm Contact	1 relay output with current carrying capacity of 1 A @ 24 V DC
Optical Fibre	
	100BaseFX multimode
Wavelength	1300 nm
Max. TX	-10 dBm
Min. TX	-20 dBm
RX Sensitivity	-32 dBm
Link Budget	12 dB
Typical Distance	5 km ^a
	4 km ^b
Saturation	-6 dBm
^a 50/125 µm, 800 MHz*km fibre optic cable	
^b 62.5/125 µm, 500 MHz*km fibre optic cable	
Power Requirements	
Input Voltage	24 V DC (12 to 45 V DC), redundant dual inputs
Input Current	IE-SW-VL05M-5TX: 0.24 A @ 24 V IE-SW-VL05M-3TX-2ST/2SC: 0.32 A @ 24 V
Overload Current Protection	Present
Connection	1 removable 6-contact terminal block
Reverse Polarity Protection	Present
Physical Characteristics	
Housing	Metal, IP 3D protection
Dimensions (W x H x D)	53.6 x 135 x 105 mm (2.11 x 5.31 x 4.13 in)
Weight	IE-SW-VL05M-...5TX/3TX-2SC/3TX-2ST: 650 g
Installation	TS 35, wall mounting (with optional mounting kit)

Environmental Limits	
Operating Temperature	Standard models: 0 to 60 °C (32 to 140 °F) Models with extended temperature range: -40 to 75 °C (-40 to 167 °F)
Storage Temperature	-40 to 85 °C (-40 to 185 °F)
Ambient Relative Humidity	5 to 95 % (non-condensing)
Regulatory Approvals	
Safety	UL 508, UL 60950-1, CSA C22.2 No. 60950-1, EN60950-1
Hazardous Location	UL/cUL Class I, Division 2, Groups A, B, C and D
EMI	FCC Part 15, CISPR (EN55022) class A
EMC	EN61000-4-2 (ESD), level 3; EN61000-4-3 (RS), level 3; EN61000-4-4 (EFT), level 3; EN61000-4-5 (Surge), level 3; EN61000-4-6 (CS), level 3; EN61000-4-8
Maritime	DNV
Shock	IEC 60068-2-27
Freefall	IEC 60068-2-32
Vibration	IEC 60068-2-6
MTBF (mean time between failures)	
Time	852,421 hrs
Database	Telcordia (Bellcore), GB
Warranty	
Warranty Period	5 years

Ordering data			
Version	Model Type	Operating Temperature	Order No.
5 * RJ45	IE-SW-VL05M-5TX	0 to +60 °C	1504280000
5 * RJ45	IE-SW-VL05MT-5TX	-40 to +75 °C	1504310000
3 * RJ45, 2 * SC-Multimode	IE-SW-VL05M-3TX-2SC	0 to +60 °C	1504330000
3 * RJ45, 2 * SC-Multimode	IE-SW-VL05MT-3TX-2SC	-40 to +75 °C	1504350000
3 * RJ45, 2 * ST-Multimode	IE-SW-VL05M-3TX-2ST	0 to +60 °C	1504370000
3 * RJ45, 2 * ST-Multimode	IE-SW-VL05MT-3TX-2ST	-40 to +75 °C	1504390000

Accessories		
	Model Type	Order No.
External Backup and Restore Module	EBR-Module RS232	1241430000
19" Rack Mounting Kit	RM-KIT	1241440000
Wall mounting kit	IE-WALLMOUNT-KIT-46MM	1504440000

Managed Switches Fast Ethernet – Value Line

8-Port Managed Entry-level Ethernet Switches

- Supports the automation protocols Modbus/TCP, PROFINET RT and EtherNet/IP
- Turbo Ring and Turbo Chain with fast recovery time (<20 ms @ 250 switches)
- IGMP snooping, QoS, port- and tag-based VLAN
- Configurable error messages via SNMP trap, e-mail or relay output
- User-friendly, web-based configuration and management

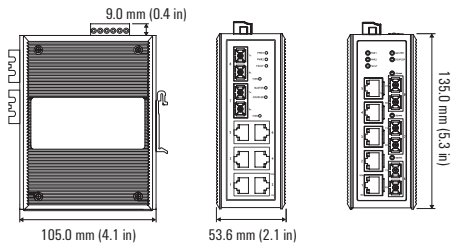

Technical data

Standards		
IEEE 802.3 for 10BaseT ■ IEEE 802.3u for 100BaseT(X) and 100BaseFX ■ IEEE 802.3x for Flow Control ■ IEEE 802.1D-2004 for Spanning Tree Protocol ■ IEEE 802.1w for Rapid STP ■ IEEE 802.1p for Class of Service ■ IEEE 802.1Q for VLAN Tagging		
Protocols		
IGMPv1/v2 ■ GMRP ■ GVRP ■ SNMPv1/v2c/v3 ■ DHCP Server/Client ■ TFTP ■ SNMP ■ SMTP ■ RARP ■ RMON ■ HTTP ■ Telnet ■ Syslog ■ DHCP Option 66/67/82 ■ BootP ■ LLDP ■ Modbus/TCP ■ PROFINET RT (PROFINET-IO device in compliance with Conformance Class B) ■ EtherNet/IP (CIP support) ■ IPv6		
MIB		
MIB-II ■ Ethernet-like MIB ■ P-BRIDGE MIB ■ Bridge MIB ■ RSTP MIB ■ RMON MIB Group 1, 2, 3, 9 ■ Private MIB		
Flow Control		
IEEE 802.3x flow control ■ back pressure flow control		
Switch Properties		
MAC Table Size	8K	
Packet Buffer Size	1 MBit	
Interface		
Fibre Ports	100BaseFX ports (SC/ST connector)	
RJ45 Ports	10/100BaseT(X) auto negotiation speed, Full/Half duplex mode, and auto MDI/MDI-X connection	
Console Port	RS 232 (RJ45 connector)	
DIP Switches	Turbo Ring, Master, Coupler, Reserve	
LED Indicators	PWR1, PWR2, FAULT, MSTR/HEAD, CPLR/TAIL, 10/100M	
Alarm Contact	1 relay output with current carrying capacity of 1 A @ 24 V DC	
Optical Fibre		
	100BaseFX	
	multimode	singlemode
Wavelength	1300 nm	1310 nm
Max. TX	-10 dBm	0 dBm
Min. TX	-20 dBm	-5 dBm
RX Sensitivity	-32 dBm	-34 dBm
Link Budget	12 dB	29 dB
Typical Distance	5 km ^a	40 km ^c
	4 km ^b	
Saturation	-6 dBm	-3 dBm
^a 50/125 µm, 800 MHz*km fibre optic cable		
^b 62.5/125 µm, 500 MHz*km fibre optic cable		
^c 9/125 µm singlemode fibre optic cable		
Power Requirements		
Input Voltage	24 V DC (12 to 45 V DC), redundant dual inputs	
Input Current	IE-SW-VL08M-8TX: 0.26 A @ 24 V IE-SW-VL08M-6TX-2ST/2SC/2SCS: 0.35 A @ 24 V IE-SW-VL08M-5TX-3SC/1SC-2SCS: 0.32 A @ 24 V	
Overload Current Protection	Present	
Connection	1 removable 6-contact terminal block	
Reverse Polarity Protection	Present	
Physical Characteristics		
Housing	Metal, IP 30 protection	
Dimensions (W x H x D)	53.6 x 135 x 105 mm (2.11 x 5.31 x 4.13 in)	
Weight	IE-SW-VL08MT-...8TX/6TX-2SC/6TX-2ST/6TX-2SCS: 650 g IE-SW-VL08MT-...5TX/3SC/5TX-1SC-2SCS: 890 g	



IndustrialIT
enabled



EtherNet/IP™

PROFI
NETO

Modbus-IDA
the architecture for distributed automation

Physical Characteristics	
Installation	TS 35, wall mounting (with optional mounting kit)
Environmental Limits	
Operating Temperature	Standard models: 0 to 60 °C (32 to 140 °F) Models with extended temperature range: -40 to 75 °C (-40 to 167 °F)
Storage Temperature	-40 to 85 °C (-40 to 185 °F)
Ambient Relative Humidity	5 to 95 % (non-condensing)
Regulatory Approvals	
Safety	UL 508, UL 60950-1, CSA C22.2 No. 60950-1, EN60950-1
Hazardous Location	UL/cUL Class I, Division 2, Groups A, B, C and D; ATEX Zone 2 Ex nA nC IIC T4 Gc*
EMI	FCC Part 15, CISPR (EN55022) class A
EMC	EN61000-4-2 (ESD), level 3; EN61000-4-3 (RS), level 3; EN61000-4-4 (EFT), level 3; EN61000-4-5 (Surge), level 3; EN61000-4-6 (CS), level 3; EN61000-4-8
Maritime	DNV, GL**
Shock	IEC 60068-2-27
Freefall	IEC 60068-2-32
Vibration	IEC 60068-2-6
MTBF (mean time between failures)	
Time	1,102,845 hrs 363,000 hrs (models IE-SW-VL08MT-5TX-3SC und IE-SW-VL08MT-5TX-1SC-2SCS)
Database	Telcordia (Bellcore), GB
Warranty	
Warranty Period	5 years

Ordering data			
Version	Model Type	Operating Temperature	Order No.
8 * RJ45	IE-SW-VL08MT-8TX	-40 to +75 °C	1240940000
5 * RJ45, 3 * SC-Multimode	IE-SW-VL08MT-5TX-3SC	-40 to +75 °C	1240970000
5 * RJ45, 1 * SC-Multimode, 2 * SC-Singlemode	IE-SW-VL08MT-5TX-1SC-2SCS	-40 to +75 °C	1345240000
6 * RJ45, 2 * ST-Multimode	IE-SW-VL08MT-6TX-2ST	-40 to +75 °C	1240990000
6 * RJ45, 2 * SC-Multimode	IE-SW-VL08MT-6TX-2SC	-40 to +75 °C	1344770000
6 * RJ45, 2 * SC-Singlemode	IE-SW-VL08MT-6TX-2SCS	-40 to +75 °C	1241020000

Accessories		
	Model Type	Order No.
External Backup and Restore Module	EBR-Module RS232	1241430000
19" Rack Mounting Kit	RM-KIT	1241440000
Wall mounting kit	IE-WALLMOUNT-KIT-46MM	1504440000

Note

*ATEX-Zone 2 does not apply to the models IE-SW-VL08MT-5TX-3SC and IE-SW-VL08MT-5TX-1SC-2SCS)

** does not apply to the models IE-SW-VL08MT-5TX-3SC and IE-SW-VL08MT-5TX-1SC-2SCS

Managed Fast Ethernet Switches

- Supports the automation protocols Modbus/TCP, PROFINET RT and EtherNet/IP
- Plug-n-play Turbo Ring and Turbo Chain (<20 ms @ 250 switches)
- IEEE 1588 PTP, Modbus/TCP, LLDP, SNMP Inform, QoS, IGMP snooping, VLAN, IEEE 802.1X, HTTPS, SNMPv3, and SSH supported



EtherNet/IP



Modbus-IDA
the architecture for distributed automation

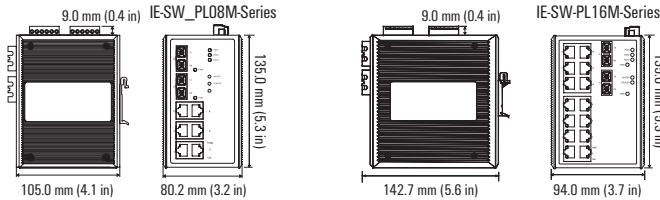

Technical data

Standards
IEEE 802.3 for 10BaseT ■ IEEE 802.3u for 100BaseT (X) and 100BaseFX ■ IEEE 802.3x for Flow Control ■ IEEE 802.1D-2004 for Spanning Tree Protocol ■ IEEE 802.1w for Rapid STP ■ IEEE 802.1Q for VLAN Tagging ■ IEEE 802.1p for Class of Service ■ IEEE 802.1X for Authentication ■ IEEE 802.3ad for Port Trunk with LACP

Protocols
IGMPv1/v2 ■ GVRP ■ SNMPv1/v2c/v3 ■ DHCP Server/Client ■ BootP ■ TFTP ■ SNTp ■ SMTP ■ RARP ■ GMRP ■ LACP ■ RMON ■ HTTP ■ HTTPS ■ Telnet ■ Syslog ■ DHCP Option 66/67/82 ■ SSH ■ SNMP Inform ■ Modbus/TCP ■ PROFINET RT (PROFINET-IO device in compliance with Conformance Class B) ■ EtherNet/IP (CIP support) ■ LLDP ■ IEEE 1588 PTP ■ IPv6

MIB
MIB-II ■ Ethernet-Like MIB ■ P-BRIDGE MIB ■ Q-BRIDGE MIB ■ Bridge MIB ■ RSTP MIB ■ RMON MIB Group 1, 2, 3, 9 ■ Private MIB

Flow Control
IEEE 802.3x flow control ■ back pressure flow control

Switch Properties

Priority Queues	4
Max. Number of Available VLANs	64
VLAN ID Range	VID 1 to 4094
IGMP Groups	256
MAC Table Size	8 K
Packet Buffer Size	1 MBit (IE-SW-PL08M series), 2 MBit (IE-SW-PL16M series)

Interface

Fibre Ports	100BaseFX ports (SC/ST connector)
RJ45 Ports	10/100BaseT(X) auto negotiation speed, Full/Half duplex mode, and auto MDI/MDI-X connection
Console Port	RS 232 (RJ45 connector)
DIP Switches	Turbo-ring, master, coupler, reserve (only IE-SW-PL08M series)
LED Indicators	PWR1, PWR2, FAULT, MSTR/HEAD, CPLR/TAIL, 10/100M
Alarm Contact	2 relay outputs with current carrying capacity of 1 A @ 24 V DC
Digital Inputs	2 inputs with the same ground, electrically isolated • +13 to +30 V for state "1" • -30 to +3 V for state "0" • Max. input current: 8 mA

Optical Fibre

	100BaseFX	
	multimode	singlemode
Wavelength	1300 nm	1310 nm
Max. TX	-10 dBm	0 dBm
Min. TX	-20 dBm	-5 dBm
RX Sensitivity	-32 dBm	-34 dBm
Link Budget	12 dB	29 dB
Typical Distance	5 km (50/125 µm multimode cable) 4 km (62.5/125 µm multimode cable)	40 km (9/125 µm singlemode cable)
Saturation	-6 dBm	-3 dBm

Power Requirements

Input Voltage	24 V DC (12 to 45 V DC), redundant dual inputs
Input Current	IE-SW-PL08M-8TX: 0.26 A @ 24 V IE-SW-PL08M-6TX-2SC/ST/2SCS: 0.36 A @ 24 V IE-SW-PL16M-16TX: 0.41 A @ 24 V IE-SW-PL16M-14TX-2SC/ST: 0.51 A @ 24 V

Power Requirements

Overload Current Protection	Present
Connection	2 removable 6-contact terminal blocks
Reverse Polarity Protection	Present

Physical Characteristics

Housing	Metal, IP 30 protection
Dimensions (W x H x D)	IE-SW-PL08M: 80.2 x 135 x 105 mm (3.16 x 5.31 x 4.13 in) IE-SW-PL16M: 94 x 135 x 142.7 mm (3.7 x 5.31 x 5.62 in)
Weight	IE-SW-PL08M: 1040 g, IE-SW-PL16M: 1586 g
Installation	TS 35, wall mounting (with optional mounting kit)

Environmental Limits

Operating Temperature	Standard Models: 0 to 60 °C (32 to 140 °F) Wide Temp. Models: -40 to 75 °C (-40 to 167 °F) (on request)
Storage Temperature	-40 to 85 °C (-40 to 185 °F)
Ambient Relative Humidity	5 to 95 % (non-condensing)

Regulatory Approvals

Safety	UL 508, UL 60950-1, CSA C22.2 No. 60950-1, EN60950-1
--------	--

Hazardous Location

UL/cUL Class I, Division 2, Groups A, B, C and D;
ATEX Zone 2 Ex nA nC IIC T4 Gc

EMI
FCC Part 15, CISPR (EN55022) class A

EMC
EN61000-4-2 (ESD): IE-SW-PL08M...Series: level 3
IE-SW-PL16M...Series: level 2;
EN61000-4-3 (RS) level 3; EN61000-4-4 (EFT) level 3;
EN61000-4-5 (Surge) level 3;
EN61000-4-6 (CS) level 3; EN61000-4-8

Maritime
DNV, GL

Shock
IEC 60068-2-27

Freefall
IEC 60068-2-32

Vibration
IEC 60068-2-6

MTBF (mean time between failures)

Time	IE-SW-PL08M...Series: 339,000 hrs IE-SW-PL16M...Series: 247,000 hrs
------	--

Database
Telcordia (Bellcore), GB

Warranty

Warranty Period	5 years
-----------------	---------

Ordering data

Version	Model Type	Operating Temperature	Order No.
8 * RJ45	IE-SW-PL08M-8TX	0 to 60 °C	1241040000
	IE-SW-PL08MT-8TX	-40 to +75 °C	1286780000
6 * RJ45, 2 * SC-Multimode	IE-SW-PL08M-6TX-2SC	0 to 60 °C	1241070000
	IE-SW-PL08MT-6TX-2SC	-40 to +75 °C	1286790000
6 * RJ45, 2 * ST-Multimode	IE-SW-PL08M-6TX-2ST	0 to 60 °C	1241080000
	IE-SW-PL08MT-6TX-2ST	-40 to +75 °C	1286800000
6 * RJ45, 2 * SC-Singlemode	IE-SW-PL08M-6TX-2SCS	0 to 60 °C	1241090000
	IE-SW-PL08MT-6TX-2SCS	-40 to +75 °C	1286810000
16 * RJ45	IE-SW-PL16M-16TX	0 to 60 °C	1241100000
	IE-SW-PL16MT-16TX	-40 to +75 °C	1286820000
14 * RJ45, 2 * SC-Multimode	IE-SW-PL16M-14TX-2SC	0 to 60 °C	1241120000
	IE-SW-PL16MT-14TX-2SC	-40 to +75 °C	1286830000
14 * RJ45, 2 * ST-Multimode	IE-SW-PL16M-14TX-2ST	0 to 60 °C	1241130000
	IE-SW-PL16MT-14TX-2ST	-40 to +75 °C	1286840000

Managed Switches Gigabit Ethernet – Premium Line

Managed Gigabit Ethernet Switches

- Supports the automation protocols Modbus/TCP, PROFINET RT and EtherNet/IP
- 2 Gigabit Ethernet ports for redundant ring and 1 Gigabit Ethernet port for uplink solution
- Ring redundancy with fast recovery time (≤ 20 ms @ 250 switches)
- IEEE 1588 PTP, LLDP, SNMP Inform, QoS, IGMP snooping, VLAN, IEEE 802.1X, HTTPS, SNMPv3, and SSH supported

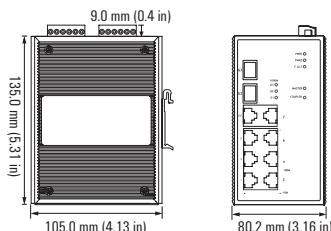

IndustrialIT
enabled



EtherNet/IP™



Modbus-IDA
the architecture for distributed automation

Technical data

Standards	
IEEE 802.3 for 10BaseT ■ IEEE 802.3u for 100BaseT (X) and 100BaseFX ■ IEEE 802.3ab for 1000BaseT(X) ■ IEEE 802.3z for 1000BaseX ■ IEEE 802.3x for Flow Control ■ IEEE 802.1D-2004 for Spanning Tree Protocol ■ IEEE 802.1w for Rapid STP ■ IEEE 802.1Q for VLAN Tagging ■ IEEE 802.1p for Class of Service ■ IEEE 802.1X for Authentication ■ IEEE 802.3ad for Port Trunk with LACP	
Protocols	
IGMPv1/v2 ■ GMRP ■ GVRP ■ SNMPv1/v2c/v3 ■ DHCP Server/Client ■ BootP ■ TFTP ■ SNMP ■ SMTP ■ RARP ■ RMON ■ HTTP ■ HTTPS ■ Telnet ■ Syslog ■ DHCP Option 66/67/82 ■ SSH ■ SNMP Inform ■ Modbus/TCP ■ PROFINET RT (PROFINET-IO device in compliance with Conformance Class B) ■ EtherNet/IP (CIP support) ■ LLDP ■ IEEE 1588 PTP ■ IPv6	
MIB	
MIB-II ■ Ethernet-Like MIB ■ P-BRIDGE MIB ■ Q-BRIDGE MIB ■ Bridge MIB ■ RSTP MIB ■ RMON MIB Group 1, 2, 3, 9 ■ Private MIB	
Flow Control	
IEEE 802.3x flow control ■ back pressure flow control	
Switch Properties	
Priority Queues	4
Max. Number of Available VLANs	64
VLAN ID Range	VID 1 to 4094
IGMP Groups	256
MAC Table Size	8 K
Packet Buffer Size	1 MBit
Interface	
Fibre Ports	1000BaseSFP-Slot (100BaseSFP modules are not supported)
RJ45 Ports	10/100BaseT(X) oder 10/100/1000BaseT(X) auto negotiation
Console Port	RS 232 (RJ45 connector)
DIP Switches	Turbo-Ring, Master, Coupler, Reserve
LED Indicators	PWR1, PWR2, FAULT, 10/100M (TP-Port), 1000M (Gigabit-Port), MSTR/HEAD, CPLR/TAIL
Alarm Contact	2 relay outputs with current carrying capacity of 1 A @ 24 V DC
Digital Inputs	2 inputs with the same ground, but electrically isolated from the electronics <ul style="list-style-type: none"> • +13 to +30 V for state "1" • -30 to +3 V for state "0" • Max. input current: 8 mA
Power Requirements	
Input Voltage	24 V DC (12 to 45 V DC), redundant dual inputs
Input Current	IE-SW-PL10M-3GT-7TX: 0.65 A @ 24 V IE-SW-PL10M-1GT-2GS-7TX: 0.44 A @ 24 V
Overload Current Protection	Present
Connection	2 removable 6-contact terminal blocks
Reverse Polarity Protection	Present
Physical Characteristics	
Housing	Metal, IP 30 protection
Dimensions (W x H x D)	80.2 x 135 x 105 mm (3.16 x 5.31 x 4.13 in)
Weight	1170 g
Installation	TS 35, wall mounting (with optional mounting kit)

Environmental Limits	
Operating Temperature	Standard Models: 0 to 60 °C (32 to 140 °F); Wide Temp. Models: -40 to 75 °C (-40 to 167 °F)
Storage Temperature	-40 to 85 °C (-40 to 185 °F)
Ambient Relative Humidity	5 to 95 % (non-condensing)
Regulatory Approvals	
Safety	UL 508, UL 60950-1, CSA C22.2 No. 60950-1, EN60950-1
Hazardous Location	UL/cUL Class 1, Division 2, Groups A, B, C and D; ATEX Zone 2 Ex nA nC IIC T4 Gc
EMI	FCC Part 15, CISPR (EN55022) Class A
EMC	EN61000-4-2 (ESD),level 3; EN61000-4-3 (RS),level 3; EN61000-4-4 (EFT),level 3; EN61000-4-5 (Surge),level 3; EN61000-4-6 (CS),level 3; EN61000-4-8
Maritime	DNV, GL
Shock	IEC 60068-2-27
Freefall	IEC 60068-2-32
Vibration	IEC 60068-2-6
MTBF (mean time between failures)	
Time	204.000 hrs
Database	MIL-HDBK-217J, GB 25 °C
Warranty	
Warranty Period	5 years

Ordering data			
Version	Model Type	Operating Temperature	Order No.
3 * RJ45 10/100/1000BaseT(X),	IE-SW-PL10M-3GT-7TX	0 to 60 °C	1241290000
7 * RJ45 10/100BaseT(X)	IE-SW-PL10MT-3GT-7TX	-40 to +75 °C	1286930000
1 * RJ45 10/100/1000BaseT(X),	IE-SW-PL10M-1GT-2GS-7TX	0 to 60 °C	1241300000
2 * Slots 1000BaseSFP,	IE-SW-PL10MT-1GT-2GS-7TX	-40 to +75 °C	1286940000
7 * RJ45 10/100BaseT(X)			

Accessories		
	Model Type	Order No.
External Backup and Restore Module	EBR-Modul RS232	1241430000
19" Rack Mounting Kit	RM-KIT	1241440000
Wall mounting kit	IE-WALLMOUNT-KIT-46MM	1504440000

Note

The IE-SW-PL10M 1GT-2GS-7TX supports up to 2x 1000Base SFP slots. Corresponding SFP modules for Gigabit Ethernet, see page F.8.

Managed Gigabit Ethernet Switches

- Supports the automation protocols Modbus/TCP, PROFINET RT and EtherNet/IP
- 2 Gigabit Ethernet ports plus 16 Fast Ethernet ports for copper and fibre
- Ring redundancy with rapid recovery time (< 20 ms @ 250 switches)
- IEEE 1588 PTP, LLDP, SNMP Inform, QoS, IGMP snooping, VLAN, IEEE 802.1X, HTTPS, SNMPv3, and SSH supported

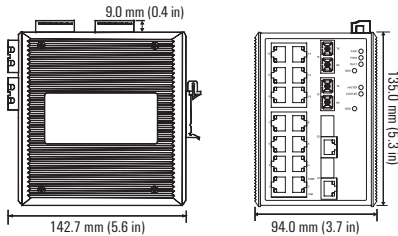

Technical data

Standards	
IEEE 802.3 for 10BaseT ■ IEEE 802.3u for 100BaseT(X) and 100BaseFX ■ IEEE 802.3ab for 1000BaseT(X) ■ IEEE 802.3z for 1000BaseX IEEE 802.3x for Flow Control ■ IEEE 802.1D-2004 for Spanning Tree Protocol ■ IEEE 802.1w for Rapid STP ■ IEEE 802.1Q for VLAN Tagging ■ IEEE 802.1p for Class of Service ■ IEEE 802.1X for Authentication ■ IEEE 802.3ad for Port-Trunk mit LACP	
Protocols	
IGMPv1/v2 ■ GMRP, GVRP ■ SNMPv1/v2c/v3 ■ DHCP Server/Client ■ BootP ■ TFTP ■ SNTp ■ SMTP ■ RARP ■ RMON ■ HTTP ■ HTTPS ■ Telnet ■ Syslog ■ DHCP-Option 66/67/82 ■ SSH ■ SNMP Inform ■ Modbus/TCP ■ PROFINET RT (PROFINET-IO device in compliance with Conformance Class B) ■ EtherNet/IP (CIP support) ■ LLDP ■ IEEE 1588 PTP ■ IPv6	
MIB	
MIB-II ■ Ethernet-like MIB ■ P-BRIDGE MIB ■ Q-BRIDGE MIB ■ Bridge MIB ■ RSTP MIB ■ RMON MIB Group 1, 2, 3, 9 ■ Private MIB	
Flow Control	
IEEE 802.3x flow control ■ back pressure flow control	
Switch Properties	
Priority Queues	4
Max. Number of Available VLANs	64
VLAN ID Range	VID 1 to 4094
IGMP Groups	256
MAC Table Size	8 K
Packet Buffer Size	2 MBit
Interface	
Fibre Ports	100BaseFX (SC/ST connection) and 1000BaseSFP slot (100BaseSFP modules are not supported)
RJ45 Ports	10/100BaseT(X) oder 10/100/1000BaseT(X) auto negotiation
Console Port	RS 232 (RJ45 connector)
LED Indicators	PWR1, PWR2, FAULT, 10/100M (TP-Port), 100M (Glasfaser-Port), MSTR/HEAD, CPLR/TAIL
Alarm Contact	2 relay outputs with current carrying capacity of 1 A @ 24 V DC
Digital Inputs	2 inputs with the same ground, but electrically isolated from the electronics. <ul style="list-style-type: none"> • +13 to +30 V for state "1" • -30 to +3 V for state "0" • Max. input current: 8 mA

	Optical Fibre	
	100BaseFX	
	multimode	singlemode
Wavelength	1300 nm	1310 nm
Max. TX	-10 dBm	0 dBm
Min. TX	-20 dBm	-5 dBm
RX Sensitivity	-32 dBm	-34 dBm
Link Budget	12 dB	29 dB
Typical Distance	5 km (50/125 µm multimode cable) 4 km (62.5/125 µm multimode cable)	40 km (9/125 µm singlemode cable)
Saturation	-6 dBm	-3 dBm



EtherNet/IP

PROFINET
PROFINET-IO

Modbus-IDA
the architecture for distributed automation

Power Requirements	
Input Voltage	24 V DC (12 to 45 V DC), redundant dual inputs
Input Current	IE-SW-PL18M-2GC-16TX: 0.51 A @ 24 V IE-SW-PL18M-SC/ST/SCS: 0.61 A @ 24 V
Overload Current Protection	Present
Connection	2 removable 6-contact terminal blocks
Reverse Polarity Protection	Present
Physical Characteristics	
Housing	Metal, IP 30 protection
Dimensions (W x H x D)	94 x 135 x 142.7 mm (3.7 x 5.31 x 5.62 in)
Weight	1630 g
Installation	TS 35, wall mounting (with optional mounting kit)
Environmental Limits	
Operating Temperature	Standard Models: 0 to 60 °C (32 to 140 °F) Wide Temp. Models: -40 to 75 °C (-40 to 167 °F)
Storage Temperature	-40 to 85 °C (-40 to 185 °F)
Ambient Relative Humidity	5 to 95 % (non-condensing)
Regulatory Approvals	
Safety	UL 508, UL 60950-1, CSA C22.2 No. 60950-1, EN60950-1
Hazardous Location	UL/cUL Class I, Division 2, Groups A, B, C and D; ATEX Zone 2 Ex nA nC IIC T4 Gc
EMC	FCC Part 15, CISPR (EN55022) Class A EN61000-4-2 (ESD), level 2; EN61000-4-3 (RS), level 3; EN61000-4-4 (EFT), level 2; EN61000-4-5 (Surge), level 3; EN61000-4-6 (CS), level 3; EN61000-4-8; EN61000-4-12
Maritime	DNV, GL
Shock	IEC 60068-2-27
Freefall	IEC 60068-2-32
Vibration	IEC 60068-2-6
MTBF (mean time between failures)	
Time	240.000 hrs
Database	Telcordia (Bellcore), GB
Warranty	
Warranty Period	5 years

Ordering data			
Version	Model Type	Operating Temperature	Order No.
16 * RJ45 10/100BaseT(X), 2 * Combo Ports ¹	IE-SW-PL18M-2GC-16TX IE-SW-PL18MT-2GC-16TX	0 to +60 °C -40 to +75 °C	1241320000 1286970000
14 * RJ45 10/100BaseT(X), 2 * SC-Multimode 100BaseFX, 2 * Combo Ports ¹	IE-SW-PL18M-2GC14TX2SC IE-SW-PL18MT-2GC14TX2SC	0 to +60 °C -40 to +75 °C	1241330000 1286990000
14 * RJ45 10/100BaseT(X), 2 * ST-Multimode 100BaseFX, 2 * Combo Ports ¹	IE-SW-PL18M-2GC14TX2ST IE-SW-PL18MT-2GC14TX2ST	0 to +60 °C -40 to +75 °C	1241340000 1287000000
14 * RJ45 10/100BaseT(X), 2 * SC-Singlemode 100BaseFX, 2 * Combo Ports ¹	IE-SW-PL18M-2GC14TX2SCS IE-SW-PL18MT-2GC14TX2SCS	0 to +60 °C -40 to +75 °C	1241350000 1287010000

Note
The IE-SW-PL18M series supports up to 2x 1000Base SFP slots. Corresponding SFP modules for Gigabit Ethernet, see page F.8.

¹ (10/100/1000BaseT(X) or 100/1000BaseSFP)

Managed Full Gigabit Ethernet Switch

- Supports the automation protocols Modbus/TCP, PROFINET RT and EtherNet/IP
- 4 10/100/1000BaseT(X) ports plus 5 combo (10/100/1000BaseT(X) or 100/1000BaseSFP slot) Gigabit ports
- Ring redundancy with rapid recovery time (≤ 20 ms @ 250 switches)
- IEEE 1588 PTP, LLDP, SNMP Inform, QoS, IGMP snooping, VLAN, IEEE 802.1X, HTTPS, SNMPv3, and SSH supported

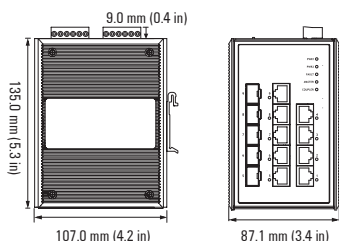
IndustrialIT
enabled

EtherNet/IP™

PROFI
NETO
PROFIBUS-DP/PROFINET-IO

Modbus-IDA
the architecture for distributed automation

Technical data

Standards	
IEEE 802.3 for 10BaseT ■ IEEE 802.3u for 100BaseT (X) and 100BaseFX ■ IEEE 802.3ab for 1000BaseT(X) ■ IEEE 802.3z for 1000BaseX ■ IEEE 802.3x for Flow Control ■ IEEE 802.1D-2004 for Spanning Tree Protocol ■ IEEE 802.1w for Rapid STP ■ IEEE 802.1Q for VLAN Tagging ■ IEEE 802.1p for Class of Service ■ IEEE 802.1X for Authentication ■ IEEE 802.3ad for Port Trunk with LACP	
Protocols	
IGMPv1/v2 ■ GMRP ■ GVRP ■ SNMPv1/v2c/v3 ■ DHCP Server/Client ■ DHCP Option 66/67/82 ■ BootP ■ TFTP ■ SNTP ■ SMTP ■ RARP ■ RMON ■ HTTP ■ HTTPS ■ Telnet ■ SSH ■ Syslog ■ Modbus/TCP ■ PROFINET RT (PROFINET-IO device in compliance with Conformance Class B) ■ EtherNet/IP (CIP support) ■ SNMP Inform ■ LLDP ■ IEEE 1588 PTP ■ IPv6	
MIB	
MIB-II ■ Ethernet-Like MIB ■ P-BRIDGE MIB ■ Q-BRIDGE MIB ■ Bridge MIB ■ RSTP MIB ■ RMON MIB Group 1, 2, 3, 9 ■ Private MIB	
Flow Control	
IEEE 802.3x flow control ■ back pressure flow control	
Switch Properties	
Priority Queues	4
Max. Number of Available VLANs	64
VLAN ID Range	ID 1 to 4094
IGMP Groups	256
MAC Table Size	8 K
Packet Buffer Size	1 MBit
Interface	
Fibre Ports	100/1000Base SFP Slot
RJ45 Ports	10/100/1000BaseT(X) auto negotiation
Console Port	RS 232 (RJ45 connector)
DIP Switches	Turbo-Ring, Master, Coupler, Reserve
LED Indicators	PWR1, PWR2, FAULT, 10/100/1000M, MSTR/HEAD, CPLR/TAIL
Alarm Contact	2 relay outputs with current carrying capacity of 1 A @ 24 V DC
Digital Inputs	2 inputs with the same ground, but electrically isolated from the electronics <ul style="list-style-type: none"> • +13 to +30 V for state "1" • -30 to +3 V for state "0" • Max. input current: 8 mA
Power Requirements	
Input Voltage	12/24/48 V DC, redundant dual inputs
Input Current	0.81 A @ 24 V
Overload Current Protection	Present
Connection	2 removable 6-contact terminal blocks
Reverse Polarity Protection	Present
Physical Characteristics	
Housing	Metal, IP 30 protection
Dimensions (W x H x D)	87.1 × 135 × 107 mm (3.43 × 5.31 × 4.21 in)
Weight	1510 g
Installation	TS 35, wall mounting (with optional mounting kit)

Environmental Limits	
Operating Temperature	Standard Models: 0 to 60 °C (32 to 140 °F) Wide Temp. Models: -40 to 75 °C (-40 to 167 °F)
Storage Temperature	-40 to 85 °C (-40 to 185 °F)
Ambient Relative Humidity	5 to 95 % (non-condensing)
Regulatory Approvals	
Safety	UL 508, EN60950-1
EMI	FCC Part 15, CISPR (EN55022) Class A
EMC	EN61000-4-2 (ESD), level 3; EN61000-4-3 (RS), level 3; EN61000-4-4 (EFT), level 3; EN61000-4-5 (Surge), level 3; EN61000-4-6 (CS), level 3; EN61000-4-8
Maritime	DNV, GL
Shock	IEC 60068-2-27
Freefall	IEC 60068-2-32
Vibration	IEC 60068-2-6
MTBF (mean time between failures)	
Time	330.000 hrs
Database	Telcordia (Bellcore), GB
Warranty	
Warranty Period	5 years

Ordering data			
Version	Model Type	Operating Temperature	Order No.
4 * RJ45 10/100/1000BaseT(X)	IE-SW-PL09M-5GC-4GT	0 to 60 °C	1241370000
5 * Combo Ports ¹	IE-SW-PL09MT-5GC-4GT	-40 to +75 °C	1287020000

Accessories		
	Model Type	Order No.
External Backup and Restore Module	EBR-Modul RS232	1241430000
19" Rack Mounting Kit	RM-KIT	1241440000
Wall mounting kit	IE-WALLMOUNT-KIT-46MM	1504440000

Note

The IE-SW-PL09M series supports up to 5x 100/1000Base SFP slots. Corresponding SFP modules for Fast/Gigabit Ethernet, see page F.8.

¹ (10/100/1000BaseT(X) or 100/1000BaseSFP)

Power over Ethernet switches

Power and data transferred in parallel

Power over Ethernet (PoE) describes a process where power can be supplied to a network-compatible device over the 8-wire Ethernet cable. In a narrower sense, PoE today means the IEEE 802.3af (DTE Power over MDI) standard which was adopted in June 2003.

The main advantage of Power over Ethernet is that you do not require a separate power supply cable and so can install Ethernet devices in hard-to-reach places or in areas where there is not sufficient room for many cables. This means that you can save some significant installation costs, and that you can also integrate the power supply into a central uninterruptible power supply (UPS) to improve the reliability of the connected devices.

PoE is used by network devices that need small amounts of power. It is typically used for IP telephones, network cameras, operating panels or wireless communications devices such as WLAN access points.

Weidmüller PoE switches support the IEE 802.3at standard (also known as PoE+) and can therefore supply end devices with up to 30 W per PoE port.

Weidmüller PoE switches also offer further advantages by their simple power supply needs. They do not require an additional 48 V supply in addition to the standard 24 V supply.

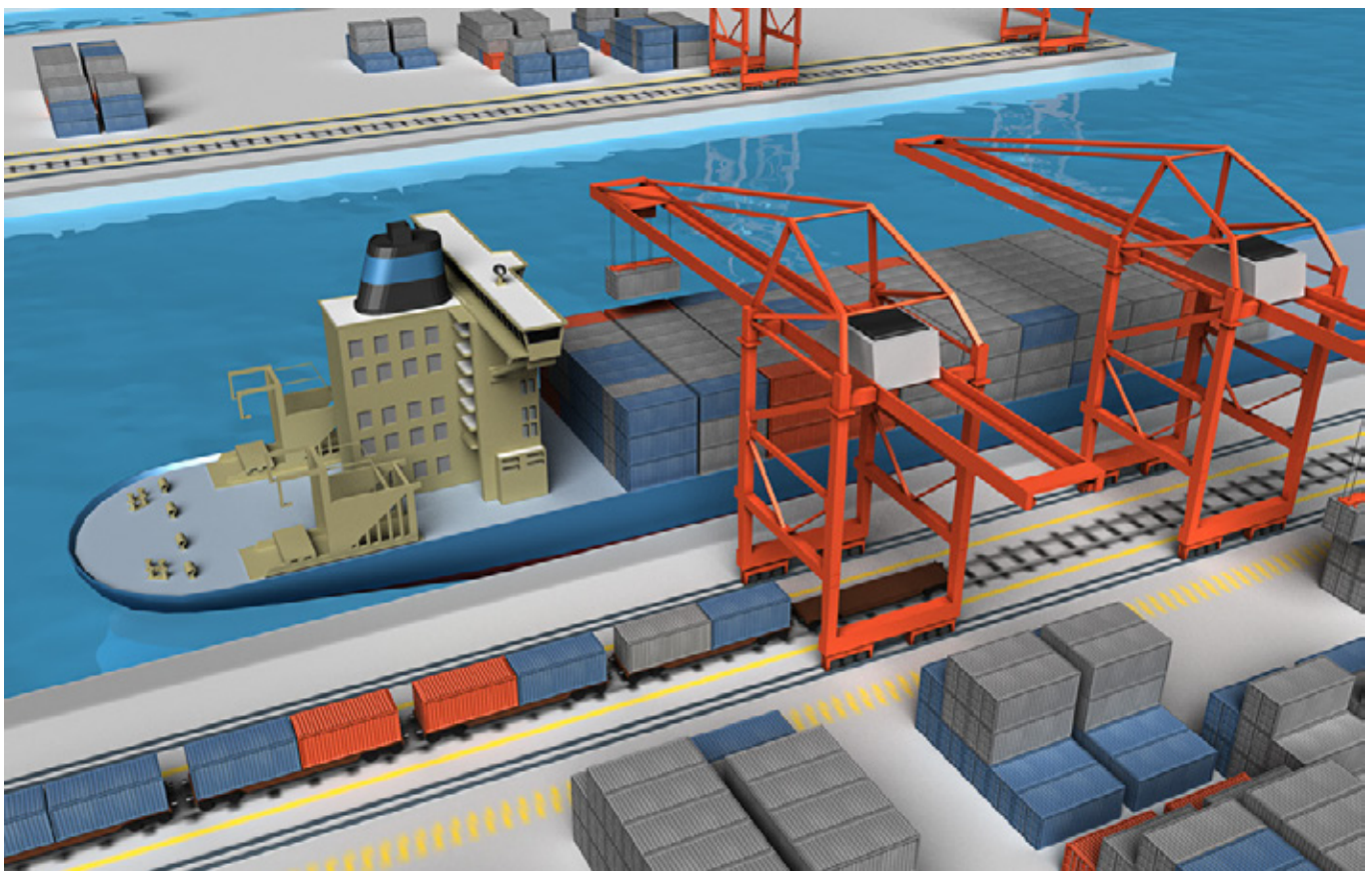

Unmanaged Fast Ethernet PoE+ Switch

- 4 IEEE 802.3af/at compliant PoE ports
- Up to 30 watts per PoE port
- 24/48 V DC redundant wide-range power supply
- Integrated DC/DC converter can supply 48 V-PoE devices across the entire input voltage range of 24 to 48 V DC
- Intelligent power consumption detection and classification
- Broadcast Storm Protection

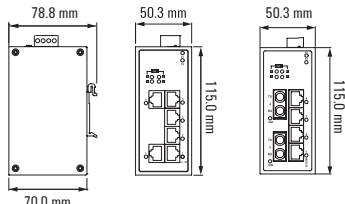

Technical data

Technology	
Standards	802.3af/at for Power over Ethernet IEEE 802.3 for 10BaseT IEEE 802.3u for 100BaseT(X) and 100BaseFX IEEE 802.3x for Flow Control
Processing Type	Store and Forward
Flow Control	IEEE 802.3x flow control, back pressure flow control
Switch Properties	
MAC table size	1 K
Packet buffer size	512 KB
Interface	
Fibre-optic ports	100BaseFX ports (SC/ST connector, multimode)
RJ45 Ports	10/100BaseT(X) auto negotiation speed, Full/Half duplex mode and auto MDI/MDI-X connection
DIP Switches	Enable/disable broadcast storm protection
PoE pin assignment	V-, V-, V+, V+ for pin 1, 2, 3, 6 (endspan, MDI-X alternative A)
LED Indicators	PWR1, PWR2, 10/100M (TP-Port), 100M (Fibre-optic port), PoE
Optical Fibre	
	100BaseFX multimode
Wavelength	1300 nm
Max. Transmit power	-10 dBm
Min. Transmit power	-20 dBm
RX Sensitivity	-32 dBm
Link Budget	12 dB
Typical Distance	5 km (50/125 µm multimode cable) 4 km (62,5/125 µm multimode cable)
Saturation	-6 dBm
Power Requirements	
Input Voltage	24/48 (20 to 60 V) V DC, 2 redundant inputs
Input Current	Max 7.5 A @ 24 V DC (supports up to 4 ports at 30 watts per PoE port)
Overload Current Protection	Present
Connection	1 removable 4-contact terminal block
Reverse Polarity Protection	Present
Physical Characteristics	
Housing	Aluminium, IP 30 protection
Dimensions (W x H x D)	50 x 115 x 70 mm (1.96 x 4.52 x 2.76 in)
Weight	375 g
Installation	TS 35
Environmental Limits	
Operating Temperature	Standard Models: 0 to 60 °C (32 to 140 °F) Wide Temp. Models: -40 to 75 °C (-40 to 167 °F)
Storage Temperature	-40 to 85 °C (-40 to 185 °F)
Ambient Relative Humidity	5 to 95 % (non-condensing)

Regulatory Approvals

Safety	UL 69050-1, UL 508
EMC	FCC Part 15 Subpart B Class A, EN 55022 Class A EN61000-4-2 (ESD), level 3; EN61000-4-3 (RS), level 3; EN61000-4-4 (EFT), level 4; EN61000-4-5 (Surge), level 4; EN61000-4-6 (CS), level 3; EN61000-4-8
Shock	IEC 60068-2-27
Freefall	IEC 60068-2-32
Vibration	IEC 60068-2-6
MTBF (mean time between failures)	
Time	645.138 hrs
Datenbase	Telcordia (Bellcore), GB
Warranty	
Warranty Period	5 years

Ordering data

Version	Type	Operating Temperature	Order No.
2 * RJ45 10/100 BaseT(X),	IE-SW-BL06-2TX-4PoE	0 to +60 °C	1241380000
4 * RJ45 10/100 BaseT(X) PoE+	IE-SW-BL06T-2TX-4PoE	-40 to +75 °C	1286920000
1 * RJ45 10/100 BaseT(X),	IE-SW-BL06-1TX-4PoE-1SC	0 to +60 °C	1504250000
4 * RJ45 10/100 BaseT(X) PoE+,	IE-SW-BL06T-1TX-4PoE-1SC	-40 to +75 °C	1504260000
1 * SC-Multimode			
1 * RJ45 10/100 BaseT(X),	IE-SW-BL06-1TX-4PoE-1ST	0 to +60 °C	1504270000
4 * RJ45 10/100 BaseT(X) PoE+,	IE-SW-BL06T-1TX-4PoE-1ST	-40 to +75 °C	1504290000
1 * ST-Multimode			
4 * RJ45 10/100 BaseT(X) PoE+,	IE-SW-BL06-4PoE-2SC	0 to +60 °C	1504210000
2 * SC-Multimode	IE-SW-BL06T-4PoE-2SC	-40 to +75 °C	1504220000
4 * RJ45 10/100 BaseT(X) PoE+,	IE-SW-BL06-4PoE-2ST	0 to +60 °C	1504230000
2 * ST-Multimode	IE-SW-BL06T-4PoE-2ST	-40 to +75 °C	1504240000

Accessories

	Type	Order No.
19" Rack Mounting Kit	RM-KIT	1241440000
Wall mounting kit	IE-WALLMOUNT-KIT-46MM	1504440000

Unmanaged Switches Gigabit Ethernet - Power over Ethernet – Basic Line

Unmanaged Gigabit Ethernet PoE+ Switches

- Full Gigabit on all ports
- IEEE 802.3af/at compliant PoE ports
- Up to 30 W per PoE+ port
- 24/48 V DC redundant wide-range power supply
- Support for jumbo frames (9.6 KB)
- Intelligent power consumption detection and classification
- Intelligent PoE surge voltage and short-circuit protection

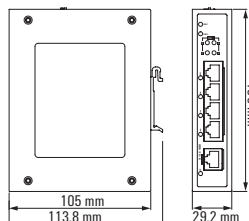

Technical data

Technology	
Standards	802.3af/at for Power over Ethernet IEEE 802.3 for 10BaseT IEEE 802.3u for 100BaseT(X) IEEE 802.3ab for 1000BaseT IEEE 802.3z for 1000BaseX IEEE 802.3x for Flow Control
Processing Type	Store and Forward
Flow Control	IEEE 802.3x flow control, back pressure flow control
Switch Properties	
MAC table size	8 K
Packet buffer size	1088 KBit
Interface	
Fibre-optic ports	1000BaseSFP-Slot
RJ45 Ports	10/100/1000BaseT(X) auto negotiation speed, Full/Half duplex mode and auto MDI/MDI-X connection
DIP Switches	Enable/disable broadcast storm protection Enable/disable jumbo frame support
PoE pin assignment	V+, V+, V-, V- for Pin 1, 2, 3, 6 (endspan, MDI alternative A)
LED Indicators	PWR1, PWR2, 10/100/1000M (TP-Port), 1000M (SFP-Slot), PoE
Power Requirements	
Input Voltage	24/48 (20 to 60 V) V DC, 2 redundant inputs
Input Current	Max 7.5 A @ 24 V DC (supports up to 4 ports at 30 watts per PoE port)
Overload Current Protection	Present
Connection	2 removable 2-pin terminal blocks
Reverse Polarity Protection	Present
Physical Characteristics	
Housing	Aluminium, IP 30 protection
Dimensions (W x H x D)	29 x 135 x 105 mm (1.14 x 5.31 x 4.13 Zoll)
Weight	360 g
Installation	TS 35
Environmental Limits	
Operating Temperature	Standard Models: 0 to 60 °C (32 to 140 °F) Wide Temp. Models: -40 to 75 °C (-40 to 167 °F)
Storage Temperature	-40 to 85 °C (-40 to 185 °F)
Ambient Relative Humidity	5 to 95 % (non-condensing)
Regulatory Approvals	
Safety	UL 508
EMC	FCC Part 15 Subpart B Class A, EN 55022 Class A EN61000-4-2 (ESD), level 3; EN61000-4-3 (RS), level 3; EN61000-4-4, level 4; EN61000-4-5 (Surge), level 4; EN61000-4-6 (CS), level 3; EN61000-4-8
Shock	IEC 60068-2-27
Freefall	IEC 60068-2-32
Vibration	IEC 60068-2-6

MTBF (mean time between failures)	
Time	1.257.910 hrs
Database	Telcordia (Bellcore), GB

Warranty	
Warranty Period	5 years

Ordering data			
Version	Type	Operating Temperature	Order No.
1 * RJ45 10/100/1000 BaseT(X),	IE-SW-BL05-1GT-4GTPoE	0 to +60 °C	1504320000
4 * RJ45 10/100/1000 BaseT(X) PoE+	IE-SW-BL05T-1GT-4GTPoE	-40 to +75 °C	1504340000
1 * 1000BaseSFP Slot,	IE-SW-BL05-1GS-4GTPoE	0 to +60 °C	1504360000
4 * RJ45 10/100/1000 BaseT(X) PoE+	IE-SW-BL05T-1GS-4GTPoE	-40 to +75 °C	1504380000

Accessories		
	Type	Order No.
19" Rack Mounting Kit	RM-KIT	1241440000
Wall mounting kit	IE-WALLMOUNT-KIT-30MM	1504450000

Note

The IE-SW-BL05-1GS-4GTPoE series supports up to 1x 1000Base SFP slot. Corresponding SFP modules for Gigabit Ethernet, see page F.8.

6-port IEEE 802.3af/at PoE+ managed Ethernet Switch

- 4 IEEE 802.3af/at compliant PoE ports
- Up to 30 watts per PoE port
- 24/48 V DC redundant wide-range power supply
- Integrated DC/DC converter can supply 48 V-PoE devices across the entire input voltage range of 24 to 48 V DC
- Extended PoE management functions, including PoE error checking or configuring the operational times of connected PoE devices

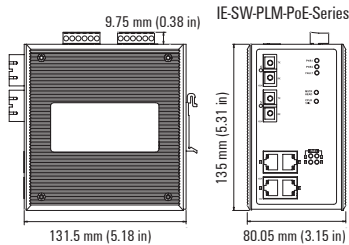

Technical data

Standards	
IEEE 802.3af/at for Power over Ethernet ■ IEEE 802.3 for 10BaseT ■ IEEE 802.3u for 100BaseT (X) and 100BaseFX ■ IEEE 802.3x for Flow Control ■ IEEE 802.1D for Spanning Tree Protocol ■ IEEE 802.1w for Rapid STP ■ IEEE 802.1Q for VLAN Tagging ■ IEEE 802.1p for Class of Service ■ IEEE 802.1X for Authentication ■ IEEE 802.3ad for Port Trunk with LACP	
Protocols	
IGMPv1/v2 ■ GMRP ■ GVRP ■ SNMPv1/v2c/v3 ■ DHCP Server/Client ■ DHCP Option 66/67/82 ■ BootP ■ TFTP ■ SNMP ■ SMTP ■ RARP ■ RMON ■ HTTP ■ HTTPS ■ Telnet ■ SSH ■ Syslog ■ Modbus/TCP ■ SNMP Inform ■ LLDP ■ IEEE 1588 PTP ■ IPv6	
MIB	
MIB-II ■ Ethernet-Like MIB ■ P-BRIDGE MIB ■ Q-BRIDGE MIB ■ Bridge MIB ■ RSTP MIB ■ RMON MIB Group 1, 2, 3, 9	
Flow Control	
IEEE 802.3x flow control ■ back pressure flow control	
Switch Properties	
Priority Queues	4
Max. Number of Available VLANs	64
VLAN ID Range	VID 1 to 4094
IGMP Groups	256
MAC Table Size	8 K
Packet Buffer Size	1 MBit
Interface	
RJ45 Ports	10/100BaseT(X) auto negotiation speed, Full/Half duplex mode and auto MDI/MDI-X connection
PoE pin assignment	V-, V+, V+, V+ for pin 1, 2, 3, 6 (endspan, MDI-X alternative A)
Console Port	RS 232 (RJ45 connector)
DIP Switches	Turbo Ring, Master, Coupler, Reserve
LED Indicators	PWR1, PWR2, FAULT, 10/100M, MSTR/HEAD, CPLR/TAIL, PoE
Alarm Contact	2 relay outputs with current carrying capacity of 1 A @ 24 V DC
Alarm Contact	2 inputs with the same ground, electrically isolated <ul style="list-style-type: none"> • +13 to +30 V for state "1" • -30 to +3 V for state "0" • Max. input current: 8 mA
Power Requirements	
Input Voltage	24/48 (20 to 60 V) V DC
Input Current	Max. 7.8 A @ 24 V DC (supports up to 4 ports at 30 watts per PoE port)
Overload Current Protection	Present
Connection	2 removable 6-contact terminal blocks
Reverse Polarity Protection	Present
Technical data	
Housing	Metal, IP 30 protection
Dimensions (W x H x D)	80 x 135 x 131.5 mm (3.15 x 5.31 x 5.18 in)
Weight	1270 g
Installation	DIN-Rail mounting

Environmental Limits	
Operating Temperature	Standard Models: 0 to 60 °C (32 to 140 °F) Wide Operating Temp. Models: -40 to 75 °C (-40 to 167 °F)
Storage Temperature	-40 to 85 °C (-40 to 185 °F)
Ambient Relative Humidity	5 to 95 % (non-condensing)
Regulatory Approvals	
Safety	UL 508
EMI	FCC Part 15, CISPR (EN55022) class A
EMC	EN61000-4-2 (ESD), level 3; EN61000-4-3 (RS), level 3; EN61000-4-4 (EFT), level 3; EN61000-4-5 (Surge), level 3; EN61000-4-6 (CS), level 3; EN61000-4-8
Shock	IEC 60068-2-27
Freefall	IEC 60068-2-32
Vibration	IEC 60068-2-6
MTBF (mean time between failures)	
Time	433.000 hrs
Database	Telcordia (Bellcore), GB
Warranty	
Warranty Period	5 years

Ordering data			
Version	Type	Operating Temperature	Order No.
2 * RJ45 10/100 BaseT(X), 4 * RJ45 10/100 BaseT(X) PoE+	IE-SW-PL06M-2TX-4PoE	0 to 60 °C	1241390000
	IE-SW-PL06MT-2TX-4PoE	-40 to +75 °C	1286910000

Accessories		
	Type	Order No.
External Backup and Restore Module	EBR-Modul RS232	1241430000
19" Rack Mounting Kit	RM-KIT	1241440000
Wall mounting kit	IE-WALLMOUNT-KIT-46MM	1504440000

Industrial Security Router Overview

Industrial Security Router	Industrial Security Router introduction	C.2
	Industrial Security Router	C.6

Gigabit Industrial Security Router

Secure data communication with integrated VPN technology

You want to be able to communicate with your machinery and systems securely, reliably, and from anywhere? Should only verified data gain access to your industrial network? Then the new Industrial Security Router from Weidmüller is just the right choice.

Due to the steady increase in networking data and information in office-based communication, a strong trend has evolved where the advantages of Ethernet communication are progressively being used in the area of industrial automation technology.

As well as the standardisation provided by Ethernet technology, vertical data integration from the field/production level across the office network to the Internet is an important driver for its rapid spread in industrial applications.

In addition to LAN switching technologies, we are seeing increased use of industrial routers for enhanced security and for efficient management of data traffic between LANs.

Routers with integrated VPN technologies are also ideally suited to secure remote access to components and systems in the LAN, via either a wired or wireless Internet connection.

Technical features of Weidmüller routers at a glance

Compact and robust industrial-grade metal housing (aluminium die casting)

Gigabit Ethernet interfaces (LAN/WAN) for high data throughput

Digital inputs/outputs (24 V DC) with functions for disconnecting WAN port, indicating alarm status, starting/stopping of pre-configured VPN connections and indicating active VPN tunnel

Supports all standard router functions such as static/dynamic routing, SNMP, DHCP server, Dynamic DNS, event logging or DSL connection (PPPoE) via external DSL modem

Flexibly configurable stateful inspection firewall with filter functions for both Layer 3 (IP layer) and Layer 2 (MAC address level)

Extensive configuration options for IP address mapping (1:1 NAT, virtual mapping/NAT masquerading/port-forwarding/IP address forwarding), e.g. for connecting multiple machine networks in the same IP address range into a primary production network



Integrated VPN functionality (OpenVPN and IPSec) for secure remote access over the Internet. The router can be used with both VPN technologies, either as a VPN client or a VPN server.

Variable bandwidth management by prioritising and limiting network traffic to IP and Ethernet protocol level

Variable user management through multiple user profiles with detailed assignment of rights

Integrated Modbus/TCP server for controlling and querying the status of the digital inputs and outputs and pre-configured VPN connections with Modbus/TCP-capable devices (e.g. PLC)

Client Monitoring for the monitoring of network devices

“Remote Capture” function for monitoring network traffic via Wireshark, (Network protocol analyser software)

IE-SR-2GT-UMTS/3G variant

Additional integrated UMTS/3G/HSPA + modem for Internet connection via mobile radio (max. downlink 21.2 Mbps, max. uplink 5.8 Mbps)

Securely integrate machines in a production network with Gigabit Ethernet

The router enables controlled and secure data exchange between “switched” Ethernet networks (IP routing). The various manifestations of the Network Address Translation function (1:1 NAT, masquerading, virtual mapping, port and IP forwarding) provide controlled access to both sub-networks as well as individual Ethernet devices. In addition, the 1:1 NAT function allows machine networks with the same IP address range to be easily integrated into a primary production network, as is typically the case in series machine manufacturing. The high-speed performance of the Gigabit interface means that the router will have no problems at all handling future increased data loads in the Ethernet network.

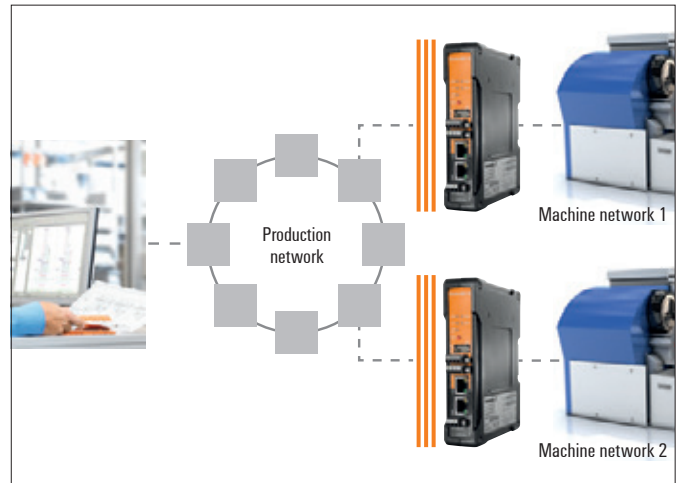

Remote access via secure VPN connections

Weidmüller Industrial Ethernet routers use encrypted VPN connections (OpenVPN and IPsec) to allow access to machines and systems. Diagnosis and error rectification are therefore possible from any location. This means that an onsite service technician can be dispensed with in many cases. The router supports the standard VPN technologies OpenVPN and IPsec, and can be operated either as a VPN client or a VPN server (with no limits on the number of simultaneously usable clients).

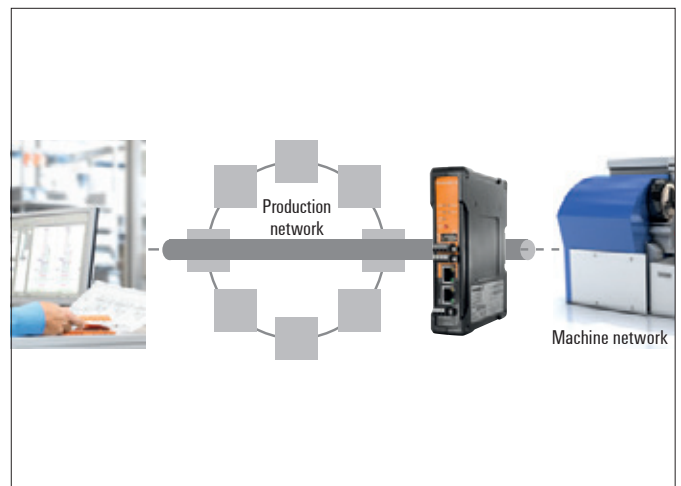

Control and monitoring via integrated digital inputs and outputs

The router is equipped with 2 digital inputs (“Cut” and “VPN initiate”) and 2 digital outputs (“Alarm” and “VPN active”). The 24 V input “Cut” allows the RJ45 WAN port to be temporarily disabled, e.g. to prevent unauthorised access by third parties to the WAN network during maintenance work on the LAN network. The 24 V input “VPN initiate” enables a pre-configured VPN instance to be started or stopped (client or server). Connections can be initiated, for example, by an external key switch or via the digital output of a controller (PLC). Once a VPN tunnel is successfully established and activated it is indicated by the digital output “VPN active”. The 24 V output “Alarm” can be used to display the router’s configurable alarm conditions externally. An alarm can be triggered by a firewall rule or when a network device is no longer accessible (client monitoring).



Intelligent Firewall: Stateful Packet Inspection

The integrated stateful inspection firewall is used to control incoming and outgoing traffic on all router interfaces (LAN, WAN, UMTS, VPN tunnels) on both Layer 2 (Ethernet frames) and Layer 3 (IP-based). An “auto-learning” function (“SecureNow!”) is also incorporated; this performs an automatic analysis of network traffic and generates a set of rules, which the user can then apply or modify as needed.

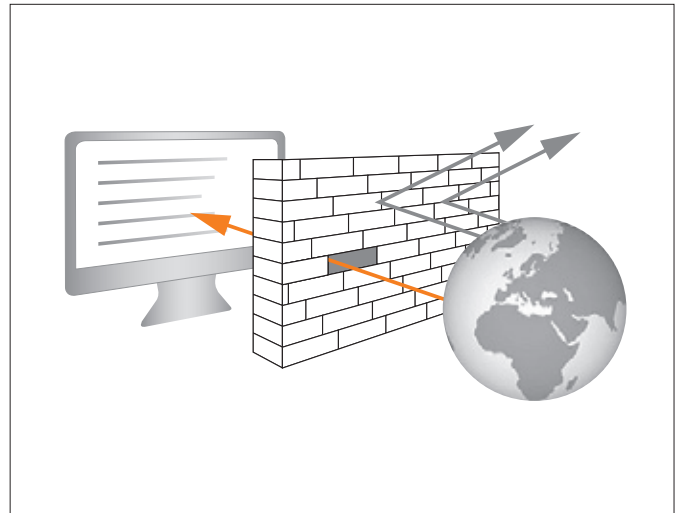

User-friendly configuration via web interface

The router can be configured using any standard browser. The clear menu structure provides easy-to-learn and intuitive user guidance. The user interface can be switched between German and English. Configuration support for users is provided by integrated online help (tool tips) with detailed instructions about the various settings. Profiles for different user groups (administrators, restricted users, etc.) can be created with detailed assignment of rights.

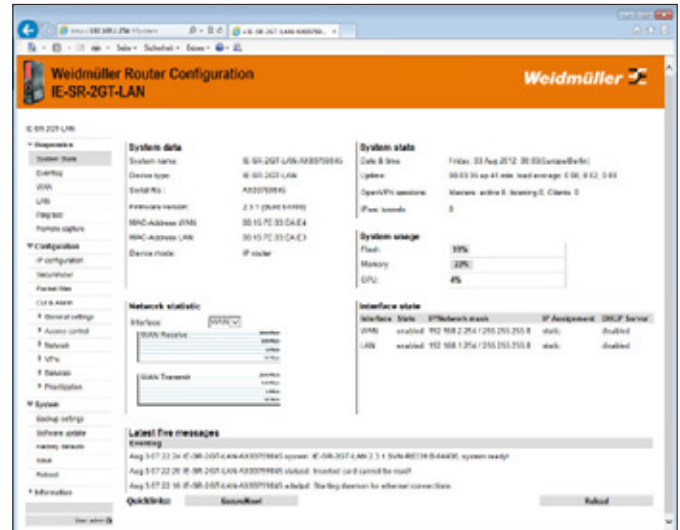

Router Search Utility – search for routers on the network

The freely available **Weidmüller Router Search Utility** software tool allows Weidmüller routers to be detected on the local network in the case of unrecognised IP addresses. For all devices found, the most important basic data such as network parameters, serial number, device name, etc. are displayed for device identification. In addition, the IP address of a router can be modified or the web interface of a selected router opened directly.

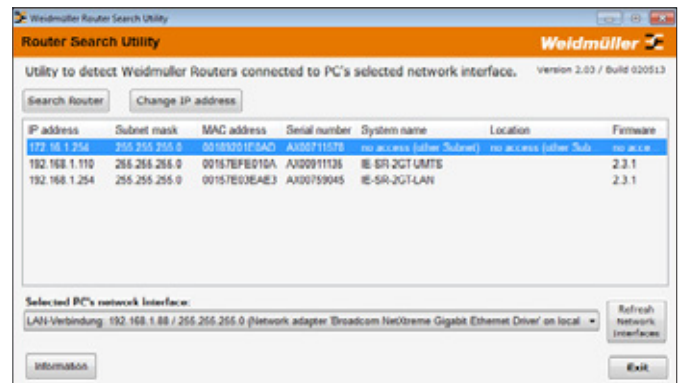

Industrial Security Router

Gigabit Industrial Security Router

- High data throughput through Gigabit Ethernet interfaces
- Integrated stateful packet inspection firewall with flexible 2-way packet filtering
- NAT masquerading, 1:1 network mapping and port forwarding
- Remote access via VPN (OpenVPN, IPsec, L2TP)
- Key switch function for activation/deactivation of WAN/VPN connection
- Variant with integrated 3G/UMTS modem for high-speed, Internet-based mobile communications access (1345250000, IE-SR-2GT-UMTS/3G)
- Variant without VPN function for NAT and security applications (1489940000, IE-SR-2GT-LAN-FN)
- Back-up and recovery of device configuration using SIM card



Technical data

Operation modes	
IP Router	Static or dynamic routing, supporting RIPv2 / OSPF
Transparent Bridge	2-port switch with additional layer-2 filter
Network Services	
	<ul style="list-style-type: none"> • DHCP server / DHCP relay • DNS relay • NTP client • DynDNS (DHCP client by RFC 2136)
Firewall	
	<ul style="list-style-type: none"> • IPv4 Stateful inspection Firewall (incoming/outgoing) • NAT-Masquerading, 1:1 NAT, Portforwarding • Layer-2/3-Filter (VLAN ID, VLAN, QoS tag, MAC address, Ethertype frame) • "Auto learning" feature to create packet filter rules (analysis of network traffic) • Layer 2/3-based packet prioritization (Ethernet frame, IP header, VLAN tag)
VPN functionality*	
OpenVPN	<ul style="list-style-type: none"> • Configurable as OpenVPN server or client (Layer 2 and Layer 3) • Authentication with X.509 Certificates • Tunnel support via HTTP proxy • Maximum of 10 different client or server configurations • Unlimited number of client connections in server mode
IPsec	<ul style="list-style-type: none"> • Can be configured as an IPsec server or client • PSK authentication (user ID, password) or X.509 certificates • Hardware-based encryption for faster data throughput • A maximum of 64 simultaneous connections (subnet to subnet or as an IPsec server) • Encryption algorithms DES-56, 3DES-168, AES 128, AES 192, AES-256
Management	
	<ul style="list-style-type: none"> • Configuration via WEB interface (HTTP / HTTPS) • Web interface in German or English • Configuration support through detailed help information (tooltip) • Configurable multi-user access with definable rights mask • Support of SNMP v1/v2/v3, event log / syslog
Miscellaneous	
Modbus/TCP	Integrated Modbus TCP Server for status queries, and software-based activation / de-activation of VPN connections
Diagnosis	"Remote Capture" feature for network diagnostics via a connected PC (Wireshark)
Monitoring	Client Monitoring (via ICMP) with alarm function in case of error
DSL and UMTS/HSPA	
DSL	Connection to the DSL modem via LAN or WAN port Free configuration of the PPPoE login
DynDNS	Support automatic registration
UMTS/3G	<ul style="list-style-type: none"> • Built-in quad-band UMTS / HSPA+ modem (only variant IE-SR-2GT-UMTS/3G) • Peak Downlink 21.1 Mbps, Peak Uplink 5.76 Mbps • GSM/GPRS/EDGE: 850 Mhz, 900 Mhz, 1800 Mhz, 1900 Mhz • UMTS/WCDMA/HSDPA/HSUPA: 850 Mhz, 900 Mhz, 1900 Mhz, 2100 Mhz • FCC, CE, IC, NCC, PTCRB, Bell, AT&T

* is not supported by the model IE-SR-2GT-LAN-FN

Interfaces		
RJ45 ports	2x10/100/1000BaseT(X)	
USB port	Option for future expansion	
SCM card reader	Save and restore of the configuration using a smart card (memory chip)	
LED indicators	Signaling states for power, status, cut, alert, active VPN connection and an active UMTS connection	
Digital outputs	<ul style="list-style-type: none"> • "Alarm" -> Indicates a configurable network status or error (24 V out) • "VPN-active" -> Indicates an active VPN connection (24 V out)* 	
Digital inputs	<ul style="list-style-type: none"> • „Cut“ -> Disconnects physically (link down) the WAN port (24 V) • "VPN-initiate" -> Enables a pre-configured VPN connection (24 V)* 	
Reset button	Restoring the factory default	
Power Requirements		
Input Voltage	1x 24 V DC (7 to 36 volts)	
Current consumption	max. 600 mA @ 24 V DC	
Technical data (housing)		
Housing	Metal, IP 20 protection	
Dimensions (W x H x D)	35 x 159 x 134 mm (without antenna) 35 x 255 x 134 mm (with UMTS antenna)	
Installation	TS 35	
Environmental Limits		
Operating temperature	-20 °C to +70 °C	
Storage Temperature	-20 °C to +85 °C	
Ambient humidity	6 to 90 % not condensing	
Approvals		
Security	UL 508	
EMC	EN301 489-1/-7/-24, FCC Part 15 Class A, EN 55022 Class A, EN61000-4-2 (ESD), EN61000-4-3 (RS) EN61000-4-4 (EFT), EN61000-4-5 (Surge), EN61000-4-6 (CS)	
Shock	DIN EN 60068-2-27	
Vibration	DIN EN 60068-2-6	
Warranty		
Warranty Period	3 years	
Ordering data		
Version	Type	Order No.
Security/NAT/VPN Router	IE-SR-2GT-LAN	1345270000
Security/NAT Router	IE-SR-2GT-LAN-FN	1489940000
Security/NAT/VPN Router with integrated UMTS/3G modem	IE-SR-2GT-UMTS/3G	1345250000

Mobile radio antennas and connection cables, see page F.6 f.

Media converter and protocol gateways

Overview

Media converter and protocol gateways	Media converter	D.2
	Serial/Ethernet converter	D.4
	Serial/fibre-optic converter	D.6
	Modbus TCP/RTU Gateway	D.8

Media converter

A smooth transition from copper to fibre-optic cables

If high interference immunity is needed or long transmission distances are involved, then fibre-optic cables are advisable. Another advantage of using fibre-optic cabling is the insensitivity to lightning or voltage surges. The use of fibre-optic based systems is already established in areas such as the process industry, plant engineering, energy distribution and wind energy.

Multimode glass fibres allow distances of up to 5,000 m to be bridged without intermediate repeaters. Singlemode fibres can be used over distances of up to 40 km.

D One simple and inexpensive solution is offered by the media converter. This connects the Ethernet via an RJ45 port to an optical fibre-optic cable port with SC or ST glass fibre connections. This retains the collision domain between the two Ethernet participants and means that there is status transparency exchanged between the two Ethernet interfaces and the port status.



Industrial Media Converter (10/100BaseT (X) to 100BaseFX)

- 10/100BaseT(X) auto-negotiation and auto-MDI/MDI-X
- Link Fault Pass-Through (LFP)
- Power failure, port break alarm by relay output
- Redundant power inputs
- Designed for hazardous locations (Class 1 Div. 2/Zone 2)

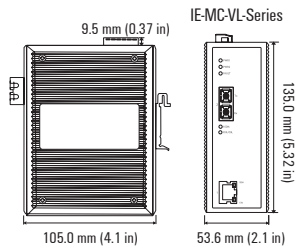
**Technical data**

Technology	
Standards	IEEE 802.3 for 10BaseT IEEE 802.3u for 100BaseT (X) and 100BaseFX
Interfaces	
Fibre Ports	100BaseFX (SC/ST connectors)
RJ45 ports	10/100BaseT(X)
DIP Switches	100BaseFX Full/Half duplex selection, port break alarm mask
LED Indicators	PWR1, PWR2, FAULT, 10/100M (TP port), 100M (Fibre port), FDX/CDL (Fibre port)
Alarm Contact	One relay output with current carrying capacity of 1 A @ 24 V DC
Optical Fibre	
	100BaseFX
	multimode singlemode
Wavelength	1300 nm 1310 nm
Max. TX	-10 dBm 0 dBm
Min. TX	-20 dBm -5 dBm
RX Sensitivity	-32 dBm -34 dBm
Link-Budget	12 dB 29 dB
Typical Distance	5 km ^a 40 km ^c 4 km ^b
Saturation	-6 dBm -3 dBm
^a 50/125 µm, 800 MHz*km fibre optic cable	
^b 62.5/125 µm, 500 MHz*km fibre optic cable	
^c 9/125 µm, 3.5 PS/(nm*km) fibre optic cable	
Power Requirements	
Input Voltage	24 V DC (12 to 48 V DC), redundant inputs
Current consumption	0.16 A (@ 24 V)
Connection	Removable terminal block
Overload Current Protection	1.1 A
Reverse Polarity Protection	Present
Technical data	
Housing	Metal, IP 30 protection
Dimensions (W x H x D)	53.6 x 135 x 105 mm (2.11 x 5.31 x 4.13 in)
Weight	630 g
Installation	TS 35
Environmental Limits	
Operating temperature	Standard Models: 0 to 60 °C (32 to 140 °F) Wide Temp. Models: -40 to 75 °C (-40 to 167 °F)
Operating Humidity	5 to 95 % RH
Storage Temperature	-40 to 85 °C (-40 to 185 °F)

Approvals	
Security	UL 508, UL 60950-1
EMI	FCC Part 15, CISPR (EN55022) class A
EMC	EN61000-4-2 (ESD), level 3
	EN61000-4-3 (RS), level 3
	EN61000-4-4 (EFT), level 3
	EN61000-4-5 (Surge), level 2;
	EN61000-4-6 (CS), level 3
	EN61000-4-8 EN61000-4-11
Hazardous Location	UL/cUL Class 1, Division 2, Groups A, B, C, and D, ATEX Zone 2 Ex nA nC IIC T4 Gc
Maritime	DNV, GL
Freefall	IEC60068-2-32
Shock	IEC60068-2-27
Vibration	IEC60068-2-6
MTBF (mean time between failures)	
Time	401.000 hrs
Database	MIL-HDBK-217F: GB 25 °C
Warranty	
Warranty Period	5 years

Ordering data			
Version	Type	Operating Temperature	Order No.
1 * RJ45, 1 * SC-Multimode	IE-MC-VL-1TX-1SC	0 to +60 °C	1241400000
	IE-MC-VLT-1TX-1SC	-40 to +75 °C	1286880000
1 * RJ45, 1 * ST-Multimode	IE-MC-VL-1TX-1ST	0 to +60 °C	1241410000
	IE-MC-VLT-1TX-1ST	-40 to +75 °C	1286890000
1 * RJ45, 1 * SC-Singlemode	IE-MC-VL-1TX-1SCS	0 to +60 °C	1241420000
	IE-MC-VLT-1TX-1SCS	-40 to +75 °C	1286900000

Accessories		
	Type	Order No.
19" Rack Mounting Kit	RM-KIT	1241440000
Wall mounting kit	IE-WALLMOUNT-KIT-46MM	1504440000

Serial/Ethernet converter

Simple integration of end devices into Ethernet networks

Serial interfaces such as RS232, RS422 or RS485 are widespread today in automation systems. To integrate these devices into modern Industrial Ethernets, Serial/Ethernet converters are used which offer investment protection for existing automation components. These devices include control systems, sensors, meters, drives, bar code readers and operator displays.

D Weidmüller's Serial/Ethernet converters connect these devices simply and easily to existing Ethernet network structures. The configuration of the serial port and Ethernet port parameters is done using an internet browser. On the Ethernet side, these devices support several operating modes: including TCP server, TCP client, UDP, Real COM, RFC 2217, Reverse Telnet, Pair Connection and

Ethernet modem. These modes ensure compatibility for the network software.

There are two Ethernet ports on the device which can be used as Ethernet switch ports. This helps to reduce your cabling costs since you no longer need to connect each device with a separate Ethernet switch.



1 and 2-port Serial/Ethernet Converter for industrial automation

- High surge protection for the serial ports, LAN ports and power supply connection
- Rugged screw-type terminal blocks for power and serial connectors
- Cascading Ethernet ports for easy wiring
- Redundant DC power inputs
- Warning by relay output and email
- Low power consumption

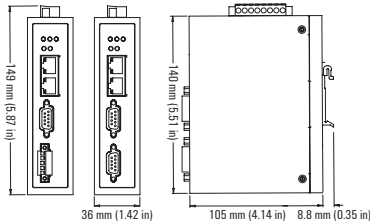
**Technical data**

Ethernet Interface	
Number of Ports	2
Speed	10/100 MBit/s, auto MDI/MDIX
Connection	8-pin RJ45
Magnetic Isolation Protection	1.5 kV built-in
Ethernet Line Protection	1 kV (level 2) surge protection
Serial Interface	
Number of Ports	IE-CS-2TX-1RS232/485: 1, IE-CS-2TX-2RS232/485: 2
Serial Standards	RS 232/422/485
Connection	IE-CS-2TX-1RS232/485: DB9 for RS 232, terminal block for RS 422/485 IE-CS-2TX-2RS232/485: DB9 for RS 232/422/485
Serial Line Protection	<ul style="list-style-type: none"> • 15 kV ESD protection for all signals • 1 kV (level 2) surge protection
RS 485 Data Direction Control	ADDC® (automatic data direction control)
Serial Communication Parameters	
Data Bits	5, 6, 7, 8
Stop Bits	1, 1.5, 2
Parity	None, Even, Odd, Space, Mark
Flow Control	RTS/CTS and DTR/DSR (RS 232 only), XON/XOFF
Baud rate	50 bit/s to 921.6 kbit/s
Serial Signals	
RS 232	TxD, RxD, RTS, CTS, DTR, DSR, DCD, GND
RS 422	Tx+, Tx-, Rx+, Rx-, GND
RS 485 4w	Tx+, Tx-, Rx+, Rx-, GND
RS 485 2w	Data+, Data-, GND
Software	
Network Protocols	ICMP, IP, TCP, UDP, DHCP, BOOTP, Telnet, Rtelnet, DNS, SNMP, HTTP, SMTP, SNTIP, IGMP
Configuration Options	Web Console, Serial Console, Telnet Console, Windows Utility
Windows Real COM Drivers	Windows 95/98/ME/NT/2000, Windows XP/2003/Vista/2008/7/8 x86/x64, 2012 x64

Technical data	
Housing	Metal, IP 30 protection
Weight	IE-CS-2TX-1RS232/485: 475 g IE-CS-2TX-2RS232/485: 485 g
Dimensions (W x H x D)	36 x 105 x 140 mm (1.42 x 4.13 x 5.51 in)
Environmental Limits	
Operating temperature	Standard Models: 0 to 60 °C (32 to 140 °F) Wide Temp. Models: -40 to 75 °C (-40 to 167 °F)
Ambient Relative Humidity	5 to 95 % RH
Storage Temperature	-40 to 85 °C (-40 to 185 °F)
Power Requirements	
Input Voltage	12 to 48 V DC
Current consumption	IE-CS-2TX-1RS232/485: 12 to 48 V DC; 220 mA @ 12 V DC, 110 mA @ 24 V DC IE-CS-2TX-2RS232/485: 12 to 48 V DC; 250 mA @ 12 V DC, 125 mA @ 24 V DC

Approvals				
EMC	CE (EN55022 Class A, EN55024), FCC Part 15 Subpart B Class A			
Security	UL 508			
Hazardous Location	UL/cUL Class 1 Division 2 Groups A, B, C and D ATEX Zone 2 Ex nA nC IIC T3 Gc			
EMC	EN61000-4-2 (ESE), Level 3 EN61000-4-3 (RS), Level 3 EN61000-4-4 (EFT), Level 4 EN61000-4-5 (Surge), Level 3 EN61000-4-6 (CS), Level 3 EN61000-4-8 EN61000-4-11			
Shock	IEC60068-2-27			
Freefall	IEC60068-2-32			
Vibration	IEC60068-2-6			
Reliability				
Alert Tools	Built-in buzzer and RTC (real-time clock)			
Automatic Reboot Trigger	Built-in WDT (watchdog timer)			
MTBF (mean time between failures)				
Time	262.805 hrs			
Database	Telcordia (Bellcore), GB			
Warranty				
Warranty Period	5 years			
Pin assignment				
RS 232/422/485 (Male DB9)	PIN	RS 232	RS 422/RS 485-4w	RS 485-2W
	1	DCD	TxD-(A)	-
	2	RxD	TxD+(B)	-
	3	TXD	RxD+(B)	Data+(B)
	4	DTR	RxD-(A)	Data-(A)
	5	GND	GND	GND
	6	DSR	-	-
	7	RTS	-	-
	8	CTS	-	-

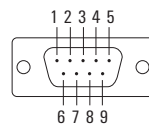

Pin Assignment			
RS 422/485 Terminal block	PIN	RS 422/RS 485-4w	RS 485-2w
	1	TxD+(B)	-
	2	TxD-(A)	-
	3	RxD+(B)	Data+(B)
	4	RxD-(A)	Data-(A)
	5	GND	GND

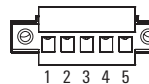

Ordering data			
Version	Type	Operating Temperature	Order No.
Two RJ45; One serial (RS232: Sub-DB9, RS422/485: terminal block)	IE-CS-2TX-1RS232/485 IE-CST-2TX-1RS232/485	0 to +60 °C -40 to +75 °C	1242080000 1285830000
Two RJ45; Two serial (RS232/422/485: Two SubDB9)	IE-CS-2TX-2RS232/485 IE-CST-2TX-2RS232/485	0 to +60 °C -40 to +75 °C	1242090000 1285840000

Accessories		
	Type	Order No.
19" Rack Mounting Kit	RM-KIT	1241440000

Serial/fibre-optic converter

Transmitting serial signals via fibre-optic cables

Serial/fibre-optic converter

If high interference immunity is needed or long transmission distances are involved, then fibre-optic transmission is advisable. Another benefit of using fibre-optic transmission is that it is not sensitive to electromagnetic influences.

One simple and inexpensive solution is media converters, which can convert serial signals from from a RS232/422/485 port on a fibre optic port with an SC or ST glass fibre connection. Fibre-optics with multimode technology make it possible to transmit over distances of up to 5000 m without additional power boosters.

Ring operation

The converter is able to connect several serial devices to form a glass fibre ring. This simply involves connecting the TX port of one converter with the Rx port of a neighbouring converter. Ring mode can then be activated using the DIP switch on the device. A signal which is transmitted by a node is then forwarded in the ring until it gets back to the sender, where it is blocked. In this way, glass fibre rings can be configured with an spread of up to 100 km.

Automatic baud rate detection

The serial/fibre-optic converter can automatically detect the serial baud rate of connected devices. This ensures that signals can be forwarded by the media converter without any data loss even if the baud rate of a connected device changes.

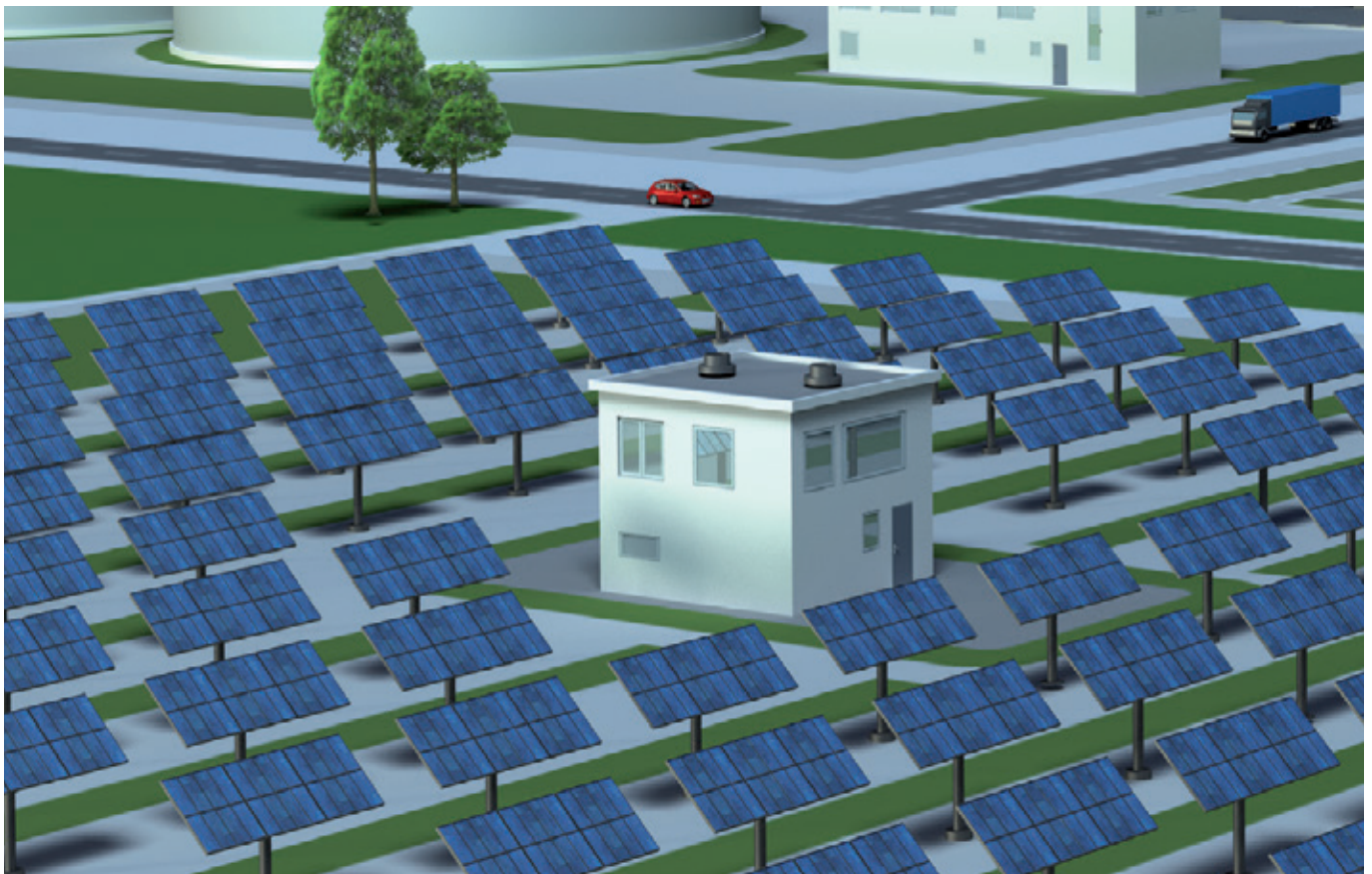

Serial/fibre-optic converters

- "Ring" and "point-to-point" modes of transmission
- Extension of RS232/422/485 transmission to up to 5 km
- Supports baud rates of 50 bps to 921.6 Kbps
- Extended temperature range of -40 to 75 °C
- Compact design

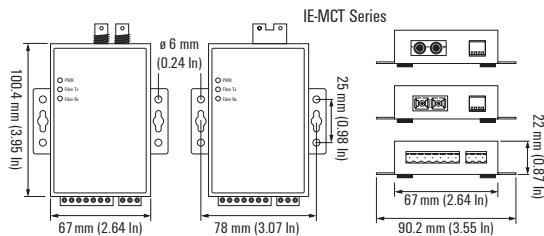

Technical data

LWL Interface	
Connection type	SC or ST connector, multimode
Wavelength	850 nm
Tx Transmit Power	> -5 dBm
Rx Sensitivity	-20 dBm
Typical Distance	5 km (50/125, 62.5/125, 100/140 µm multimode cable)
Transmission mode: "Point-to-point"	Full/Half duplex
Transmission mode: "Ring"	Half duplex
Serial Interface	
Serial Standards	RS232/422/485
Connector	terminal block
Serial Line Protection	15 kV ESD protection for all signals
Baud rate	50 bit/s to 921,6 kbit/s
RS 485 Data Direction Control	ADDC [®] (automatic data direction control)
Serial Signals	
RS 232	Tx, Rx, GND
RS 422	TxD+, TxD-, RxD+, RxD-, GND
RS 485 4w	TxD+, TxD-, RxD+, RxD-, GND
RS 485 2w	Data+, Data-, GND
Technical data	
Housing	Aluminum, IP 30 protection
LED Indicators	PWR, fibre Tx, fibre Rx
Weight	320 g
Dimensions W x H x D	with wall mounting: 67 x 100 x 22 mm (2.64 x 3.94 x 0.87 in) without wall mounting: 90 x 100 x 22 mm (3.54 x 3.94 x 0.87 in)
Environmental Limits	
Operating temperature	-40 to 75 °C (-40 to 167 °F)
Storage temperature	-40 to 75 °C (-40 to 167 °F)
Operating Humidity	5 to 95 % RH
Power Requirements	
Input voltage	12 to 48 V DC
Power consumption	140 mA @ 12 V
Serial Line Protection	2 KV Burst (EFT), EN61000-4-4 2 KV Surge, EN61000-4-5
Reverse Polarity Protection	Present
Overload Current Protection	1,1 A
Approvals	
Safety	UL 60950-1
EMC	FCC Part 15, EN55022 1998, Class B EN61000-4-2 (ESD), criterion A, level 3 EN61000-4-3 (RS), criterion A, level 3 EN61000-4-4 (EFT), criterion A, level 2 EN61000-4-5 (Surge), criterion A, level 3 EN61000-4-6 (CS), criterion A, level 2 EN61000-4-8 (SFMF), criterion A, level 1
MTBF (mean time between failures)	
Time	780.480 hrs
Database	Telcordia (Bellcore), GB
Warranty	
Warranty Period	5 years

Ordering data

Version	Type	Operating temperature	Order No.
1 * Serial (RS232/422/485: terminal block), 1 * SC multimode	IE-MCT-1RS232/485-1SC	-40 to +75 °C	1344760000
1 * Serial (RS232/422/485: terminal block), 1 * ST multimode	IE-MCT-1RS232/485-1ST	-40 to +75 °C	1362950000

Accessories

	Type	Order No.
DIN-rail mounting kit	IE-DINRAILMOUNT-KIT	1504430000

Modbus TCP/RTU Gateway

Modbus TCP/RTU Gateway

- Slave mode to support 16 TCP masters and up to 62 serial slaves simultaneously
- Master mode to support 32 TCP slaves simultaneously
- Integrated Modbus protocol analysis
- Redundant DC voltage supply inputs
- Cascaded Ethernet ports for easy cabling

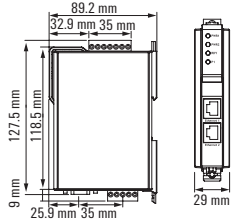

Technical data

Ethernet Interface	
Number of Ports	2
Speed	10/100 MBit/s, Auto-MDI-/MDIX
Connection	RJ45
Magnetic Isolation Protection	1.5 KV built-in
Serial Interface	
Number of Ports	1
Serial Standards	RS 232/422/485
Connection	DB9 for RS 232, terminal block for RS422/485
Serial Line Protection	15 KV ESD protection for all signals
RS 485 Data Direction Control	ADDC [®] (automatic data direction control)
Pull high/low resistor for RS 485	1 K Ω , 150 K Ω
Terminating resistor for RS 485	120 Ω
Serial Communication Parameters	
Data Bits	7, 8
Stop Bits	1, 2
Parity	None, Even, Odd, Space, Mark
Flow Control	RTS/CTS and DTR/DSR (RS 232)
Baud rate	50 bit/s to 921.6 kbit/s
Serial Signals	
RS 232	TxD, RxD, RTS, CTS, DTR, DSR, DCD, GND
RS 422	Tx+, Tx-, Rx+, Rx-, GND
RS 485 4w	Tx+, Tx-, Rx+, Rx-, GND
RS 485 2w	Data+, Data-, GND
Software	
Operating modes	RTU Slave, RTU Master, ASCII Slave, ASCII Master
Configuration Options	Web Console, Serial Console, Telnet Console, Windows Utility
Configuration tool	Modbus Gateway Administrator for Windows 98/ME/NT/2000, Windows XP/2003/Vista/2008/7 x86/x64
Multi-master and multi-drop	Master Mode: 32 TCP slaves, Slave mode: 16 TCP masters
Additional features	Serial Redirection, Priority Control
Technical data	
Housing	Plastic, IP 30 protection
Weight	190 g
Dimensions (W x H x D)	29 x 89.2 x 124.5 mm (1.14 x 3.51 x 4.90 Zoll)
Environmental Limits	
Operating temperature	Standard Models: 0 to 60 °C (32 to 140 °F), Wide Temp. Models: -40 to 75 °C (-40 to 167 °F)
Ambient Relative Humidity	5 to 95 % RH
Storage Temperature	-40 to 85 °C (-40 to 185 °F)
Power Requirements	
Input Voltage	12 to 48 V DC
Current consumption	Max. 435 mA @ 12 V DC Max. 130 mA @ 48 V DC
Connection type	1 removable 7-pin terminal block
Alarm contact	1 relay output with a current capacity of 1 A at 30 V DC

Approvals	
EMC	CE (EN55022 Class A, EN55024), FCC Part 15 Subpart B Class A
Security	UL 508
Hazardous Location	UL/cUL Class 1 Division 2 Groups A, B, C and D
EMS	EN61000-4-2 (ESD), level 3 EN61000-4-3 (RS), level 3 EN61000-4-4 (EFT), level 4 EN61000-4-5 (Surge), level 3 EN61000-4-6 (CS), level 3 EN61000-4-8 EN61000-4-11
Shock	IEC60068-2-27
Freefall	IEC60068-2-32
Vibration	IEC60068-2-6
MTBF (mean time between failures)	
Time	210.794 hrs
Database	Telcordia (Bellcore), GB

Warranty	
Warranty Period	5 years

Pin assignment		
RS 232 Terminal (Male DB9)	PIN	RS 232
	1	DCD
	2	RXD
	3	TXD
	4	DTR
	5	GND
	6	DSR
	7	RTS
	8	CTS
	9	-

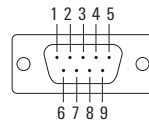

Pin assignment			
RS 422/485 Terminal Block Wiring	PIN	RS 422/RS 485-4w	RS 485-2w
	1	TxD+(B)	-
	2	TxD-(A)	-
	3	RxD+(B)	Data+(B)
	4	RxD-(A)	Data-(A)
	5	GND	GND

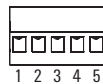

Ordering data			
Version	Type	Operating Temperature	Order No.
Two RJ45; One serial (RS232: Sub-DB9, RS422/485: terminal block)	IE-GW-MB-2TX-1RS232/485	0 to +60 °C	1504460000
	IE-GWT-MB-2TX-1RS232/485	-40 to +75 °C	1504470000

Accessories		
	Type	Order No.
19" Rack Mounting Kit	RM-KIT	1241440000

Industrial wireless Overview

Industrial wireless	Industrial wireless introduction	E.2
	Industrial wireless	E.5

Industrial wireless

Wireless communication solutions

Wireless communications are preferred when working with mobile applications or difficult-to-reach areas. Currently, wireless LAN can be used for industrial manufacturing plants or facilities; it is ideal for use anywhere where traditional cabling is not suitable or where a mobile network connection is required. For example in logistics AGVs (automatic guide vehicles) are connected over a WLAN. Here it is important that roaming between different radio cells is possible, thereby creating individually configurable radio coverage.

Support for RADIUS services and WPA2 secure encryption guarantees that your data is fully protected. Multiple wireless zones can be set up so that clients can move around as they wish, by roaming between the different radio/wireless cells. Multiple zones can be specified (multiple SSIDs) and different VLANs can be assigned for each wireless cell. This allows you to implement a one-to-one forwarding of the cable-based infrastructure to the wireless zone.

E

Weidmüller's versatile WLAN module can be used as an access point, bridge or client. It is quite simple to integrate into existing infrastructures because it has an alternative Power over Ethernet supply (using the data cable for the power supply).



Wireless operating modes

The most common operating mode for wireless networks are AP client mode (Access Point) and bridge mode. In AP-client mode an Access Point is necessary to set up a Basic Service Set (BSS) for a wireless connection. The AP can be used to create a wireless LAN, or to connect an existing WLAN with a wired network. Bridge mode offers a simple way to connect two Ethernet devices over a point-to-point connection wirelessly with one another.

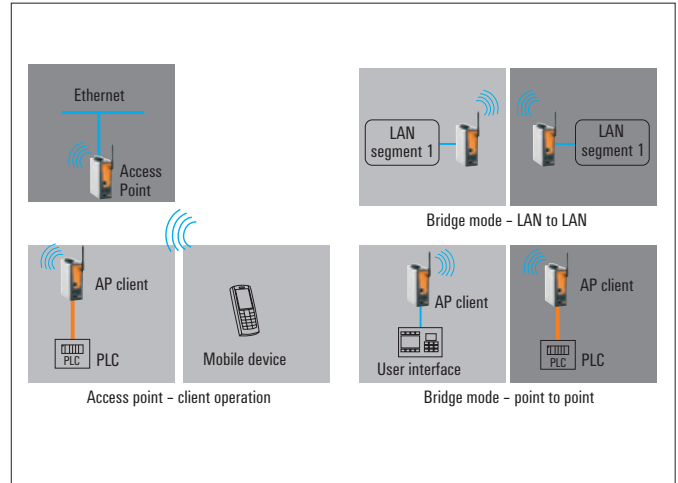

Turbo roaming for uninterrupted connections

A WLAN radio cell has a limited range depending on the antenna used. To maintain communications between devices which move over a long distance requires the connection to be passed from one access point to another. Performance can be affected where there are many moving devices and a large number of transfer points without powerful roaming technology. It is the roaming technology that offers a seamless wireless connection and permits a swift change between different wireless access points without the risk of interruption to the data communication.

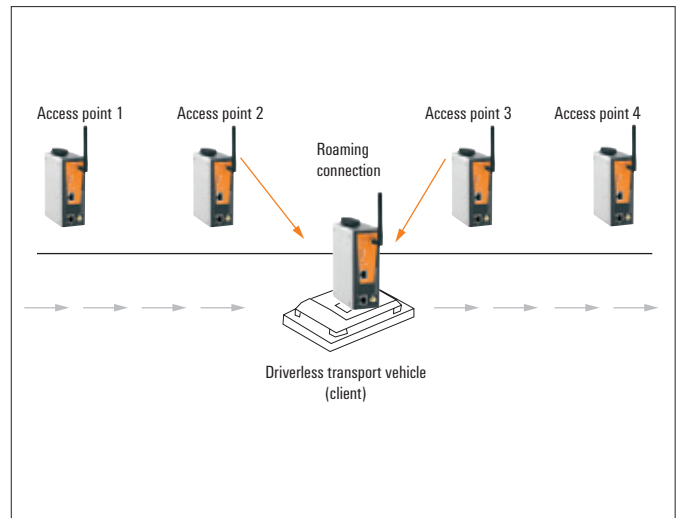

Integrated digital inputs / outputs

Wireless access points are often located in distant or inaccessible places in an industrial plant. This makes monitoring the status of a device, or its environment by the system administrators, a difficult task. Weidmüller's WLAN access points therefore have an integrated digital input/output which sends alarm messages over the network in real time to the responsible maintenance personnel when errors, like power supply failures, or link breaks, occur.

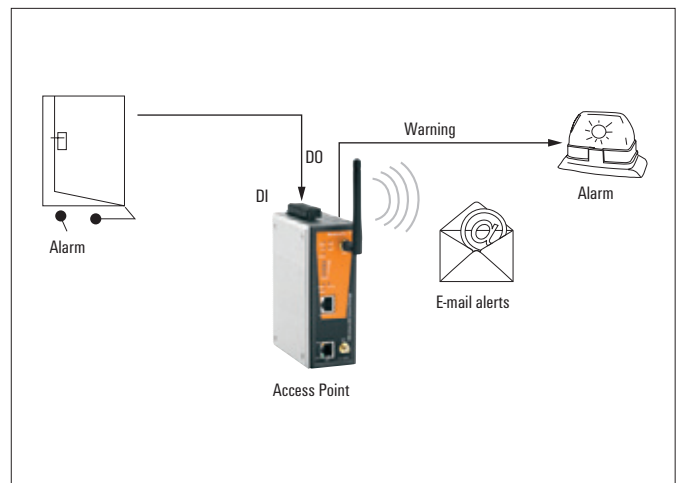

Wireless VLAN (Multi-SSID)

VLAN stands for virtual LAN. It is a network structure with all the characteristics of a normal LAN, but not geographically constrained.

Based on the SSID, two or more clients can be added into a VLAN and integrated into a LAN independently of their geographical location. Without the use of routers, a level 2 switch, in conjunction with Weidmüller WLAN access points, can distinguish broadcast domains from each other. In this way, VLANs offer administrators flexibility regarding network security, network management and scalability.

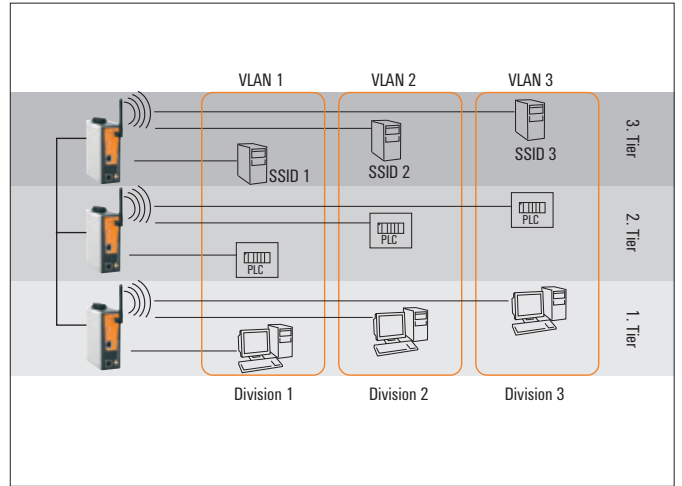

WMM for prioritising communications

Quality of Service (QoS) is a network term for controlling and measuring data transmission rates, throughput and error rates. It is an essential part of wireless communication when transmitting multimedia data like audio and video. Critical data, for example, requires a high priority with respect to the data throughput and low error rates. WMM (Wi-Fi multimedia) is based on the IEEE 802.11e protocol which was designed to integrate QoS functionality into a WLAN. The advantages lie in the prioritising of important data and the associated improvement of the communication quality.

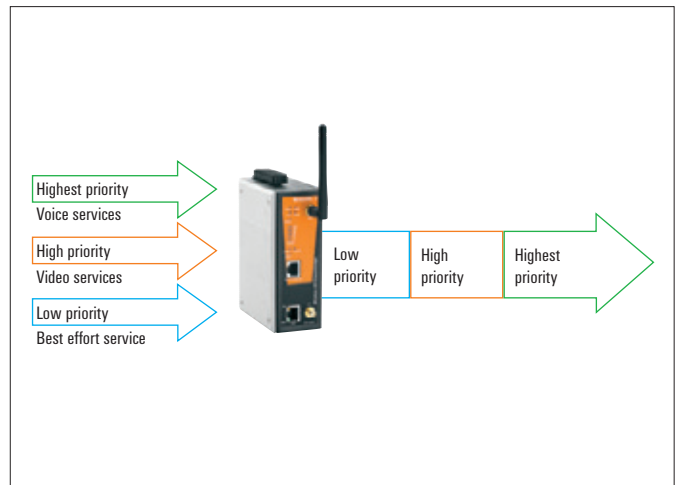

Industrial Wireless - Access point/bridge/client

- IEEE 802.11a/b/g compatible single radio module (2.4 GHz or 5 GHz band)
- Power input by redundant 24 V DC power inputs or Power-over-Ethernet
- Multi-SSID and VLAN support
- Turbo Roaming for seamless wireless connections
- Integrated DI/DO for on-site monitoring and warning
- QoS (WMM) support

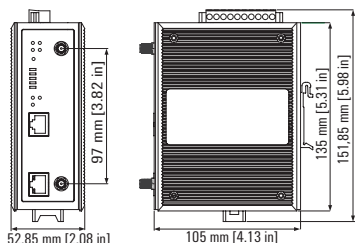

Technical data

WLAN Interface	
Standards	IEEE 802.11a/b/g for Wireless LAN IEEE 802.11i for Wireless Security IEEE 802.3u for 10/100BaseT(X) IEEE 802.3af for Power-over-Ethernet IEEE 802.1D for Spanning Tree Protocol IEEE 802.1w for Rapid STP IEEE 802.1Q VLAN
Spread Spectrum and Modulation (typical)	<ul style="list-style-type: none"> • DSSS with DBPSK, DQPSK, CCK • OFDM with BPSK, QPSK, 16QAM, 64QAM • 802.11b: CCK @ 11/5.5 Mbps, DQPSK @ 2 Mbps, DBPSK @ 11 Mbps • 802.11a/g: 64QAM @ 54/48 Mbps, 16QAM @ 36/24 Mbps, QPSK @ 18/12 Mbps, BPSK @ 9/6 Mbps
Operating Channels (central frequency)	US: 2.412 to 2.462 GHz (11 channels) 5.18 to 5.24 GHz (4 channels) EU: 2.412 to 2.472 GHz (13 channels) 5.18 to 5.24 GHz (4 channels)
Security	<ul style="list-style-type: none"> • SSID broadcast enable/disable • Firewall for MAC/IP/Protocol/Port-based filtering • 64-bit and 128-bit WEP encryption, WPA /WPA2-Personal and Enterprise (IEEE 802.1X/RADIUS, TKIP and AES)
Transmission Rates	802.11b: 1, 2, 5.5, 11 Mbps 802.11a/g: 6, 9, 12, 18, 24, 36, 48, 54 Mbps
TX Transmit Power	802.11b: Typ. 23±1.5 dBm @ 1 to 11 Mbps 802.11g: Typ. 20±1.5 dBm @ 6 to 24 Mbps, Typ. 19±1.5 dBm @ 36 Mbps, Typ. 18±1.5 dBm @ 48 Mbps, Typ. 17±1.5 dBm @ 54 Mbps 802.11a: Typ. 18±1.5 dBm @ 6 to 24Mbps, Typ. 16±1.5 dBm @ 36 to 48 Mbps, Typ. 15±1.5 dBm @ 54 Mbps
RX Sensitivity	802.11b: -97 dBm @ 1 Mbps, -94 dBm @ 2 Mbps, -92 dBm @ 5.5 Mbps, -90 dBm @ 11 Mbps 802.11g: -93 dBm @ 6 Mbps, -91 dBm @ 9 Mbps, -90 dBm @ 12 Mbps, -88 dBm @ 18 Mbps, -84 dBm @ 24 Mbps, -80 dBm @ 36 Mbps, -76 dBm @ 48 Mbps, -74 dBm @ 54 Mbps 802.11a: -90 dBm @ 6 Mbps, -89 dBm @ 9 Mbps, -89 dBm @ 12 Mbps, -85 dBm @ 18 Mbps, -83 dBm @ 24 Mbps, -79 dBm @ 36 Mbps, -75 dBm @ 48 Mbps, -74 dBm @ 54 Mbps
Protocol Support	
General Protocols	Proxy ARP, DNS, HTTP, HTTPS, IP, ICMP, SNMP, TCP, UDP, RADIUS, SNMP, PPPoE, DHCP
AP-only Protocols	ARP, BOOTP, DHCP, STP/RSTP (IEEE 802.1D/w)
Interfaces	
Default Antenna	2 dBi dual-band omni-directional antenna, RP-SMA (male)

Interfaces			
Connector for External Antennas	RP-SMA (female)		
LAN Port	10/100BaseT(X), auto negotiation speed (RJ45-type)		
Console Port	RS 232 (RJ45-type)		
LED Indicators	PWR1, PWR2, PoE, FAULT, STATE, signal strength, CLIENT MODE, BRIDGE MODE, WLAN, 10M, 100M		
Alarm Contact	1 relay output with current carrying capacity of 1 A @ 24 V DC		
Digital Inputs	2 electrically isolated inputs • +13 to +30 V for state "1" • +3 to -30 V for state "0" • Max. input current: 8 mA		
Technical data			
Housing	Metal, IP 30 protection		
Weight	850 g		
Dimensions (W x H x D)	53.6 x 135 x 105 mm (2.11 x 5.31 x 4.13 in)		
Installation	DIN-Rail mounting		
Environmental Limits			
Operating temperature	Standard Models: 0 to 60 °C (32 to 140 °F) Wide Temp. Models: -40 to 75 °C (-40 to 167 °F)		
Storage Temperature	-40 to 85 °C (-40 to 185 °F)		
Ambient Relative Humidity	5 % to 95 % (non-condensing)		
Power Requirements			
Input Voltage	12 to 48 V DC, redundant dual DC power inputs or 48 V DC Power-over-Ethernet (IEEE 802.3af compliant)		
Connection	10-pin removable terminal block		
Power Consumption	• 0.121 to 0.494 A @ 12 to 48 V DC • 0.3 A @ 24 V DC		
Reverse Polarity Protection	Present		
Approvals			
Security	EN60950-1, UL 60950-1		
Radio	EN300 328, EN301 893,		
EMC	EN301 489-1/-17, FCC Part 15 Subpart B Class B, EN55022/55024		
Hazardous Location	UL/cUL Class I, Div. 2; ATEX Zone 2 Ex nA IIC T4 Gc		
MTBF	392.209 hrs		
Warranty			
Warranty Period	5 years		
Ordering data			
Version	Type	Operating Temperature	Order No.
IEEE 802.11a/b/g Wireless AP/Bridge/Client (European version)	IE-WL-AP-BR-CL-ABG-EU	0 to +60 °C	1242100000
	IE-WLT-AP-BR-CL-ABG-EU	-40 to +75 °C	1286480000
IEEE 802.11a/b/g Wireless AP/Bridge/Client (US version)	IE-WL-AP-BR-CL-ABG-US	0 to +60 °C	1242110000
	IE-WLT-AP-BR-CL-ABG-US	-40 to +75 °C	1286490000
Accessories			
	Type		Order No.
External Backup and Restore Module	EBR-Modul RS232		1241430000
19" Rack Mounting Kit	RM-KIT		1241440000
Wall mounting kit	IE-WALLMOUNT-KIT-46MM		1504440000
WLAN antennas and connection cables, see page F.2 ff.			

Active components

Overview of accessories

Accessories – Active components	WLAN antennas and connection cables	F.2
	Mobile radio antennas and connection cables	F.6
	SFP modules (Fast Ethernet/Gigabit Ethernet)	F.8
	Module for creating configuration backup	F.9
	Mounting kits for 19" rack, wall, DIN rail	F.10

WLAN antennas and connection cables

WLAN antennas

IE-ANT-P-ABG-75-9-NF

IE-ANT-O-ABG-360-7-NF



Technical data

Electrical data			
Frequency range (Mhz)	Band 1: 2400 - 2500 (Mhz) Band 2: 5150 - 5875 (Mhz)		
Antenna gain	9 dBi band 1/2		
Beamwidth (horizontal)	75° band 1 ; 55° band 2		
Beamwidth (vertical)	55° band 1/2		
General data			
Radiation	Directional		
Impedance	50 ohm		
Polarisation	Vertical		
Connector type	1 x N-type female		
Mechanical specifications			
Dimensions	101 x 80 x 35 mm (height x width x depth)		
Weight	110 g		
Wind load	Frontal: 7N @ 160 km/h, side 7N @ 160 km/h		
Environmental Limits			
Area of application	indoors as well as outdoors		
Operating temperature	- 40 to 80 °C		
Storage Temperature	- 40 to 80 °C		
IP protection class	IP 67		
Enclosure material			
Radome colour	RAL 7044 (grey)		
Radome material	PC		
Material for base plate	-		
Ordering data			
Version	Type	Operating temperature	Order No.
802.11 a/b/g/h wireless antenna; directional	IE-ANT-P-ABG-75-9-NF	- 40 to 80 °C	1367140000
802.11 a/b/g/h wireless antenna; omnidirectional			
Note		Assembly material included in scope of supply	

Band 1: 2400 - 2500 (Mhz)	Band 2: 5150 - 5875 (Mhz)	Band 3: 3400 - 3700 (Mhz)	Band 4: 4900 - 5470 (Mhz)	Band 5: 5470 - 5935 (Mhz)
Band 1: 6 dBi	Band 2: 6 dBi	Band 3: 7 dBi	Band 4: 8 dBi	Band 5: 8 dBi
360°	-			
Omnidirectional				
50 ohm				
Vertical				
1 x N-type female				
50.6 x 86 mm (height x diameter)				
300 g				
Frontal: 10N @ 160 km/h				
indoors as well as outdoors				
- 40 to 80 °C				
- 40 to 80 °C				
IP 68				
RAL 7043 (grey)				
ASA_SAN				
Stainless steel				
Type	Operating temperature	Order No.		
IE-ANT-O-ABG-360-7-NF	- 40 to 80 °C	1367130000		
Note		Assembly material included in scope of supply		

WLAN antennas

IE-ANT-0-BG-360-6-NF

IE-ANT-0-AH-360-5-NF



Technical data

Electrical data	
Frequency range (Mhz)	2400 - 2500 (Mhz)
Antenna gain	6 dBi
Beamwidth (horizontal)	360°
Beamwidth (vertical)	30°
General data	
Radiation	Omnidirectional
Impedance	50 ohm
Polarisation	Vertical
Connector type	1 x N-type female
Mechanical specifications	
Dimensions	250 x 22 mm (height x diameter)
Weight	300 g
Wind load	Frontal: 3N @ 160 km/h, side 3N 160 km/h
Mast diameter min.	25 mm
Mast diameter max.	101 mm
Environmental Limits	
Area of application	indoors as well as outdoors
Operating temperature	- 40 to 80 °C
Storage Temperature	- 40 to 80 °C
IP protection class	IP 67
Enclosure material	
Radome colour	RAL 7035 (light grey)
Radome material	Fibre glass
Material for base plate	-

Electrical data	
Frequency range (Mhz)	5150 - 5875 (Mhz)
Antenna gain	5 dBi
Beamwidth (horizontal)	360°
Beamwidth (vertical)	25°
General data	
Radiation	Omnidirectional
Impedance	50 ohm
Polarisation	Vertical
Connector type	1 x N-type female
Mechanical specifications	
Dimensions	160 x 16 mm (height x diameter)
Weight	300 g
Wind load	Frontal: 7N @ 160 km/h, side 7N @ 160 km/h
Mast diameter min.	38.1 mm
Mast diameter max.	76.2 mm
Environmental Limits	
Area of application	indoors as well as outdoors
Operating temperature	- 45 to 70 °C
Storage Temperature	- 45 to 70 °C
IP protection class	IP 67
Enclosure material	
Radome colour	RAL 9002 (grey white)
Radome material	PP
Material for base plate	-

Electrical data	
Frequency range (Mhz)	5150 - 5875 (Mhz)
Antenna gain	5 dBi
Beamwidth (horizontal)	360°
Beamwidth (vertical)	25°
General data	
Radiation	Omnidirectional
Impedance	50 ohm
Polarisation	Vertical
Connector type	1 x N-type female
Mechanical specifications	
Dimensions	160 x 16 mm (height x diameter)
Weight	300 g
Wind load	Frontal: 7N @ 160 km/h, side 7N @ 160 km/h
Mast diameter min.	38.1 mm
Mast diameter max.	76.2 mm
Environmental Limits	
Area of application	indoors as well as outdoors
Operating temperature	- 45 to 70 °C
Storage Temperature	- 45 to 70 °C
IP protection class	IP 67
Enclosure material	
Radome colour	RAL 9002 (grey white)
Radome material	PP
Material for base plate	-

Ordering data

Version
802.11 b/g wireless antenna; omnidirectional
802.11 a/h wireless antenna; omnidirectional

Type	Operating temperature	Order No.
IE-ANT-0-BG-360-6-NF	- 40 to 80 °C	1367090000

Type	Operating temperature	Order No.
IE-ANT-0-AH-360-5-NF	- 45 to 70 °C	1367120000

Note

Assembly material included in scope of supply

Assembly material included in scope of supply



WLAN antennas and connection cables

Antenna cable

IE-CC-NM-RPSMAM-2M

IE-CC-NM-RPSMAM-4M



Technical data

Electrical data	
Impedance	50 Ohm +/- 2
Max. operating frequency	6 Ghz
Signal delay	4.08 ns/m
Attenuation @ 2.4 Ghz	approx. 0.55 dB/m
Attenuation @ 5 Ghz	approx. 0.87 dB/m

Mechanical specifications	
Length	2 m
Weight	6.3 kg/100 m
Min. bending radius (continuous)	28 mm
Connector type	Connection 1: N-type male Connection 2: RP-SMA male

Environmental Limits	
Operating temperature	-40 to 85 °C
Installation temperature	-20 to 60 °C
Flammability	IEC 60332-1, UL 1581 § 1080 (VW-1)
Halogen-free	IEC 60754
UV resistance	ISO 4892-2A

Material data	
Jacket	LSFH (modified polyethylene)
Outside diameter	5.7 mm

Ordering data

Version
Antenna cable, 2m long, N-type (male) -> RP-SMA (male), impedance 50 ohm
Antenna cable, 4m long, N-type (male) -> RP-SMA (male), impedance 50 ohm

Note

50 Ohm +/- 2
6 Ghz
4.08 ns/m
approx. 0.55 dB/m
approx. 0.87 dB/m

2 m
6.3 kg/100 m
28 mm
Connection 1: N-type male Connection 2: RP-SMA male

-40 to 85 °C
-20 to 60 °C
IEC 60332-1, UL 1581 § 1080 (VW-1)
IEC 60754
ISO 4892-2A

LSFH (modified polyethylene)
5.7 mm

Type	Order No.
IE-CC-NM-RPSMAM-2M	1367110000

50 Ohm +/- 2
6 Ghz
4.08 ns/m
approx. 0.55 dB/m
approx. 0.87 dB/m

4 m
6.3 kg/100 m
28 mm
Connection 1: N-type male Connection 2: RP-SMA male

-40 to 85 °C
-20 to 60 °C
IEC 60332-1, UL 1581 § 1080 (VW-1)
IEC 60754
ISO 4892-2A

LSFH (modified polyethylene)
5.7 mm

Type	Order No.
IE-CC-NM-RPSMAM-4M	1367100000

Note

Mobile radio antennas and connection cables

Mobile radio antenna

IE-ANT-3G-806-2170-2-NF

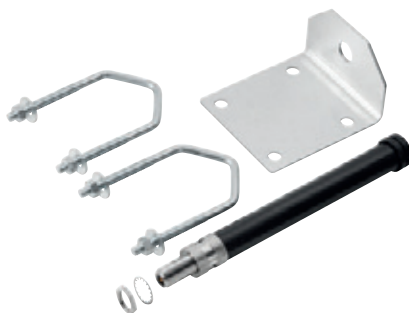

IE-ANT-3G-806-2500-4-NF



Technical data

Frequency range (Mhz)	Band 1: 806-960 (MHz) Band 2: 1710-2170 (MHz)
Antenna gain	Band 1: 1 dBi Band 2: 2dBi
Radiation	Omnidirectional
Impedance	50 ohm
Polarisation	Linear vertical
Connector type	1 x N-type female
Mechanical specifications	
Dimensions	200 x 22 mm (height x diameter)
Weight	430 g
Environmental Limits	
Area of application	for indoor and outdoor use
Operating temperature	- 40 to 85 °C
Storage Temperature	- 40 to 85 °C
IP protection class	IP 54
Enclosure material	
Radome colour	black
Radome material	Plastic

Frequency range (Mhz)	Band 1: 806-960 (MHz) Band 2: 1710-2500 (MHz)
Antenna gain	Band 1: 3 dBi Band 2: 4 dBi
Radiation	Omnidirectional
Impedance	50 ohm
Polarisation	Linear vertical
Connector type	1 x N-type female
Mechanical specifications	
Dimensions	48 x 36 mm (height x diameter)
Weight	180 g
Environmental Limits	
Area of application	for indoor and outdoor use
Operating temperature	- 40 to 70 °C
Storage Temperature	- 40 to 70 °C
IP protection class	IP 66
Enclosure material	
Radome colour	black
Radome material	Plastic

Frequency range (Mhz)	Band 1: 806-960 (MHz) Band 2: 1710-2500 (MHz)
Antenna gain	Band 1: 3 dBi Band 2: 4 dBi
Radiation	Omnidirectional
Impedance	50 ohm
Polarisation	Linear vertical
Connector type	1 x N-type female
Mechanical specifications	
Dimensions	48 x 36 mm (height x diameter)
Weight	180 g
Environmental Limits	
Area of application	for indoor and outdoor use
Operating temperature	- 40 to 70 °C
Storage Temperature	- 40 to 70 °C
IP protection class	IP 66
Enclosure material	
Radome colour	black
Radome material	Plastic

Ordering data

Version	Omni-directional antenna, mobile radio (GSM / UMTS), gain up to 2 dBi Omni-directional antenna, mobile radio (GSM / UMTS), gain up to 4 dBi
Note	

Type	Operating temperature	Order No.
IE-ANT-3G-806-2170-2-NF	- 40 to 85 °C	1491160000
Included in delivery: 1 x antenna, 1 x mounting bracket, 2 x clamps for pole mounting		

Type	Operating temperature	Order No.
IE-ANT-3G-806-2500-4-NF	- 40 to 70 °C	1491170000
Included in delivery: 1 x antenna, 1x screw connection and mounting materials for vandal-proof installation		

Connection cable mobile radio antenna

Antenna cable (2 m, 4 m, 6 m)



Technical data

General data	
Impedance	50 Ohm
Min. bending radius (repeated)	50,8 mm
Min. bending radius (once)	12,7 mm
Connector type	Connection 1: N-type (male) Connection 2: SMA (male)
Environmental Limits	
Operating temperature	-40 to 85 °C
UV resistance	Yes
Material data	
Jacket	Polyethylene
Outside diameter	4,95 mm

Ordering data

Version	Type	Order No.
Antenna cable, 2m long, N-type (male) -> SMA (male)	IE-CC-NM-SMAM-2M	1491180000
Antenna cable, 4m long, N-type (male) -> SMA (male)	IE-CC-NM-SMAM-4M	1491190000
Antenna cable, 6m long, N-type (male) -> SMA (male)	IE-CC-NM-SMAM-6M	1491210000
Note		



SFP modules (Fast Ethernet/Gigabit Ethernet)

Gigabit Ethernet SFP modules

- Compliant with IEEE 802.3z
- Differential LVPECL inputs and outputs
- TTL signal detect indicator
- Hot pluggable LC duplex connector
- Class 1 laser product; complies with EN60825-1

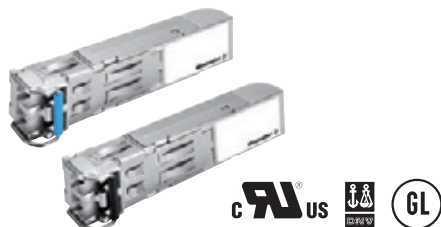

Technical data

Interfaces				
Ethernet Ports	1			
Connectors	Duplex LC Connector or Simplex LC			
Optical Fibre				
	Gigabit Ethernet			
	SFP-SX	SFP-LSX	SFP-LX	SFP-LHX
Wavelength	850 nm	1310 nm	1310 nm	1310 nm
Max. TX	-4 dBm	-1 dBm	-3 dBm	1 dBm
Min. TX	-9.5 dBm	-9 dBm	-9.5 dBm	-4 dBm
RX Sensitivity	-18 dBm	-19 dBm	-20 dBm	-24 dBm
Link Budget	8.5 dB	10 dB	10.5 dB	20 dB
Typical Distance	550 m ^{a)}	2 km ^{b)}	10 km ^{c)}	40 km ^{c)}
Saturation	0 dBm	-3 dBm	-3 dBm	-3 dBm

^{a)} 50/125 µm, 400 MHz * km or 62.5/125 µm, 500 MHz * km @ 850 nm multimode fibre optic cable

^{b)} 62.5/125 µm, 750 MHz * km @ 1310 nm multimode fibre optic cable

^{c)} 9/125 µm singlemode fibre optic cable

Note: The actual communication distance depends on many factors, including connector loss, cable deployment, and the age of the cabling system. We recommend doing a link budget analysis and reserving a 3 dB margin for such factors.

Environmental Limits	
Operating temperature	Standard Models: 0 to 60 °C (32 to 140 °F) Wide Temp. Models: -40 to 75 °C (-40 to 167 °F)
Storage Temperature	-40 to 85 °C (-40 to 185 °F)
Ambient Relative Humidity	5 to 95 % (non-condensing)
Approvals	
Security	UL, TÜV
Maritime	DNV, GL
Warranty	
Warranty Period	3 years

Ordering data			
SFP Variants	Type	Operating Temperature	Order No.
Gigabit-Ethernet, Multimode, LC Connector, 500 m	IE-SFP-1GSXLC	0 to +60 °C	1241490000
	IE-SFP-1GSXLC-T	-20 to 75 °C	1286700000
Gigabit-Ethernet, Multimode, LC Connector, 2 km	IE-SFP-1GLSXLC	0 to +60 °C	1241500000
	IE-SFP-1GLSXLC-T	-40 to 85 °C	1286710000
Gigabit-Ethernet, Singlemode, LC Connector, 10 km	IE-SFP-1GLXLC	0 to +60 °C	1241510000
	IE-SFP-1GLXLC-T	-40 to 85 °C	1286720000
Gigabit-Ethernet, Singlemode, LC Connector, 40 km	IE-SFP-1GLHXLC	0 to +60 °C	1241520000
	IE-SFP-1GLHXLC-T	-40 to 85 °C	1286730000

Fast Ethernet SFP modules

- Compliant with IEEE 802.3u
- Differential PECL inputs and outputs
- TTL signal detect indicator
- Hot pluggable LC duplex connector
- Class 1 laser product; complies with EN60825-1

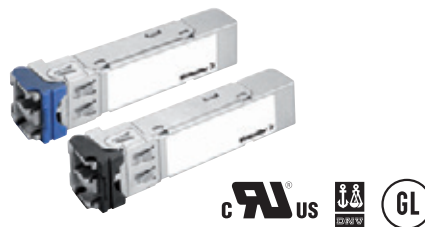

Technical data

Interfaces			
Ethernet Ports	1		
Connectors	Duplex LC Connector		
Optical Fibre			
	Fast Ethernet		
	SFP-M	SFP-S	SFP-L
Wavelength	1300 nm	1310 nm	1550 nm
Max. TX	-18 dBm	0 dBm	0 dBm
Min. TX	-8 dBm	-5 dBm	-5 dBm
RX Sensitivity	-34 dBm	-34 dBm	-34 dBm
Link Budget	26 dB	29 dB	29 dB
Typical Distance	4 km ^{a)}	40 km ^{b)}	80 km ^{b)}
Saturation	0 dBm	-3 dBm	-3 dBm

^{a)} 50/125 µm or 62.5/125 µm, 800 MHz * km @ 1300 nm multimode fibre optic cable

^{b)} 9/125 µm singlemode fibre optic cable

Environmental Limits	
Operating temperature	-40 to 85 °C (-40 to 185 °F)
Storage Temperature	-40 to 85 °C (-40 to 185 °F)
Ambient Relative Humidity	5 to 95 % (non-condensing)
Approvals	
Security	UL, TÜV
Maritime	DNV, GL
Warranty	
Warranty Period	3 years

Ordering data			
Port Variants	Type	Operating Temperature	Order No.
Fast Ethernet, Multimode, LC Connector, 4 km	IE-SFP-1FEMLC-T	-40 to +85 °C	1241450000
Fast Ethernet, Singlemode, LC Connector, 40 km	IE-SFP-1FESLC-T	-40 to +85 °C	1241470000
Fast Ethernet, Singlemode, LC Connector, 80 km	IE-SFP-1FELLC-T	-40 to +85 °C	1241480000

External Backup and Restore Module for System Configuration

- Reduce system downtime by simple reconfiguration in case of replacing devices
- Plug-n-Play system backup and restoration
- Compact, rugged, reliable design
- Can be used with all Weidmüller managed switches and WLAN components

**Technical data**

Basic Operation		
Connection	RS 232-Interface with RJ45-Connector	
Configuration	Use the WEB-Console of managed Switches	
Power Requirements		
Input Voltage	3 to 5 V DC (through the RS 232 port's RTS signal)	
Technical data		
Housing	PVC molding, IP 40 protection	
Dimensions (W x H x D)	32.5 x 97 x 12 mm (8.07 x 3.82 x 0.47 in)	
Weight	50 g	
Mounting possibility	M4 screw (< 4 mm)	
Cable Length	35 cm (including connector)	
Environmental Limits		
Operating temperature	0 to 60 °C (32 to 140 °F)	
Storage Temperature	-20 to 70 °C (-4 to 158 °F)	
Ambient Relative Humidity	5 to 95 % (non-condensing)	
Approvals		
EMI	FCC Part 15, CISPR (EN55022) Class A	
EMC	EN61000-4-2 (ESD), level 2; EN61000-4-3 (RS), level 3; EN61000-4-4 (EFT), level 3; EN61000-4-5 (Surge), level 3; EN61000-4-6 (CS), level 3	
Warranty		
Warranty Period	5 years	
Ordering data		
Version	Type	Order No.
External Backup and Restore Module	EBR-MODULE RS232	1241430000

Mounting kits for 19" rack, wall, DIN rail

Kit for 19" rack-mounting

- For mounting DIN-rail based devices in 19" racks



Technical data

Technical data	
Dimensions (W x H x D)	481 x 177.8 x 202.4 mm

Ordering data

Version	Type	Order No.
19" Rack Mounting Kit	RM-KIT	1241440000

Wall mounting kit

- Mounting kit for alternative wall-mounting of DIN rail-based Industrial Ethernet components.



Technical data

Usage	
Industrial Ethernet Switches	Product lines: IE-SW-BL05

Ordering data

Version	Type	Order No.
Wall mounting kit	IE-WALLMOUNT-KIT-30MM	1504450000

Wall mounting kit

- Mounting kit for alternative wall-mounting of DIN rail-based Industrial Ethernet components.



Technical data

Usage	
Industrial Ethernet Switches	Product lines: IE-SW- BL06/BL08 IE-SW- VL05/VL08/VL09/VL16 IE-SW- PL06/PL08/PL09/PL10/PL16/PL18
Industrial Ethernet Medienkonverter	Product lines: IE-MC-VL
Industrial Wireless Access Point	Product lines: IE-WL-AP

Ordering data

Version	Type	Order No.
Wall mounting kit	IE-WALLMOUNT-KIT-46MM	1504440000

DIN rail mounting kit

- Mounting kit for alternative mounting of Weidmüller serial/fibre-optic converters (Article 1344760000 and 1362950000) to the DIN rail.



Technical data

Usage	
Serial/fibre-optic converters	Type: 1344760000 1362950000

Ordering data

Version	Type	Order No.
DIN rail mounting kit	IE-DINRAILMOUNT-KIT	1504430000

Passive components

Introduction

Introduction – Passive components	IE-line connectors	G.2
	Cable configurator	G.4
	Differences between industrial and office Ethernet	G.6
	IE-LINE connectors: the modular principle	G.7
	IE-LINE connectors: selection chart	G.8
	PROFINET and SERCOS III cabling solutions	G.10
	EtherNet/IP cabling solutions	G.14

IE-LINE plug-in connectors

Clever and flexible with **STEADYTEC**[®] technology



STEADYTEC[®] – this name stands for the future of connection technology in the field of data and signal transmissions. Established market leaders in the industry, **STEADYTEC**[®] forms the foundation for reliable, application-orientated, standards-compliant solutions - for offices through to areas with harsh industrial conditions.

The objective: The development of reliable plug-in connector technologies for industrial applications. Technologies that satisfy the highest customer demands and hence enable new, specialised and dependable solutions.

The result: An extremely reliable, extraordinarily practical, flexible and especially efficient plug-in connector system for office and industrial applications. And using products whose characteristics accurately reflect the values originally laid out:

- fast
- reliable
- solution-based
- simple

The Ethernet connector system: clever – flexible

Connectors for modern industrial applications need to be designed in such a way that they simplify processes and cope with faster data transmission. Weidmüller's Ethernet connectors keep you a step ahead. These products are not only ready for 10 gigabit, they are also standardised for IEC 61076-3-106 and IEC 61076-3-117. In addition, the connector variants 4 (Ethernet TCP/IP), variants 5 and 1 (Ethernet IP) and variant 14 (PROFINET/AIDA) which are named in these standards are all specified as mandatory in the standards covering generic cabling systems for industrial premises: ISO/IEC 24702, IEC 61918 (Automation Island), as well as for Fieldbus installations IEC 61784-5. What's more, you have a unique choice of versions made of plastic or metal as well as inserts for copper and fibre-optic cabling. All of the connectors are designed for ease of use and for quick on-site assembly. They are also modular and can be tailored to suit your application.





Tool-free assembly and powerful connections: the RJ45 gigabit connector!

You can now securely plug the connector you need directly into your machinery with very little effort – and without a single tool! The 10-gigabit connector, with IDC-connection, was developed to provide quick, simple, secure and, most importantly, tool-free wiring.

In addition, zinc die-casting makes the connector more robust and therefore suitable for industrial applications and as it is fitted with a protected locking clip means it is suitable for meeting the requirements of harsh industrial environments. Weidmüller's IE product line fulfils the requirements for 10 GBit Ethernet, according to IEEE 802.3an, up to 500 MHz.

STEADYTEC®: Systematic benefits

- **Cat. 6_A 10 GBit System Class E_A**
- **Assembly without tools in the field**
- **Countless variations thanks to highly diverse combinations of inserts**
- **Unrestricted compatibility because standardised to IEC 61076-3-106**
- **Reliable and long-lasting thanks to use of diecast zinc**
- **Suitable for industry thanks to IP 67 class of protection**
- **Simple ordering procedure and low storage costs thanks to Weidmüller's modular system**

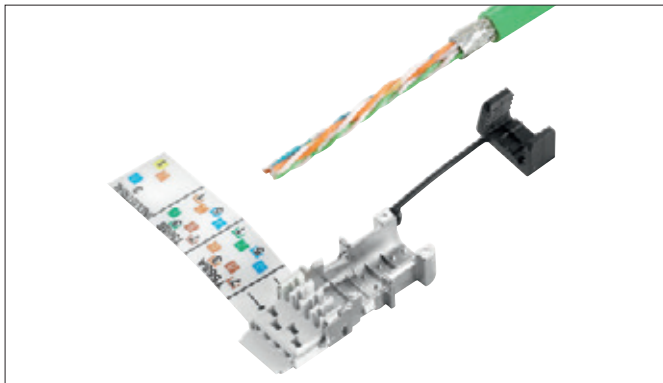

1. Strip sheath cladding and shorten shield to 5 mm



2. Prepare wires and shorten

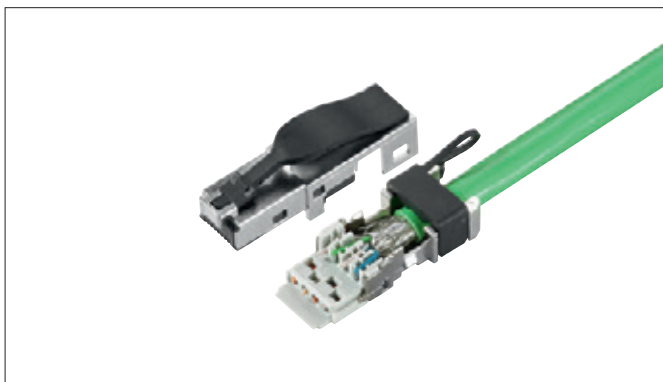

3. Snap together the two pluggable elements

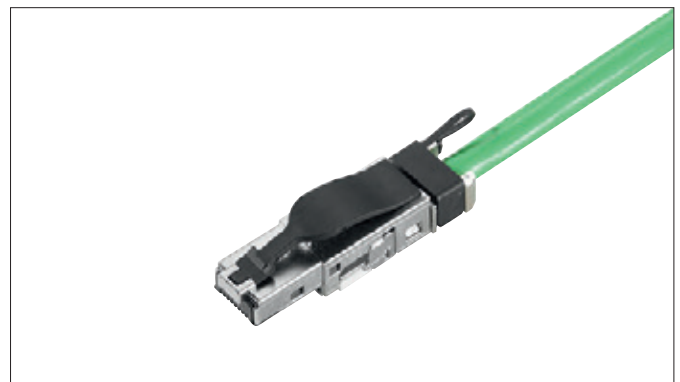

4. Finished

Cable configurator

Tailor-made connections

The cable configurator allows you to configure your specific cable with comfort, speed and simplicity. Just select, request order – and you are finished!

Make your selection from the list of available cables (material for cable sheathing, category, colour, ...). Next, choose the connector for both the right and left cable ends and then choose the cable length. Configurations which are not possible are marked in red, so that it is not possible to create an unsupported or wrong configuration.



The Industrial Ethernet Configurator can be found in our online catalogue.

Our configurator
creates connections
tailor-made.

Weidmüller

You will be forwarded directly and will be able to configure a fibre-optic or copper cable.



After you have made your selection, there are several available options:

- Locate and display the data sheet for the assembled cable
- Export the information in Excel or CSV format
- Save the configuration
- Create additional cables or load previous cables
- Place the assembled cable in the shopping cart to obtain a quote or to order



Practically all types of connectors and cables can be combined to your requirements!



From office communication to Industrial Ethernet

An overview of the differences

Office Ethernet

Industrial Ethernet



Cabling

- Fixed building installation
- Variable connection options
- Pre-assembled connection cables
- Star topology most widely in use

- Individual plant-influenced networks
- Robust component characteristics
- On-site, user assembly connections
- Redundant network topologies (ring)

Transmission

- Large volume of data
- Mid-level network availability
- Mostly only acyclical transmission
- No real-time characteristics required for standard applications

- Small data packets (measurement values)
- Very high network availability
- Extremely high real-time requirement
- Mostly cyclical transmission

Surroundings

- No extreme conditions

- Extreme temperatures
- Dust, dirt, splashing water, oils gases,
- Vibration, electromagnetic fields
- Risks of danger and damage from mechanical or chemical influences

Unlimited combinations of IE-LINE plug-in connectors

The modular principle



	Plug insert	Plug housing	Flange-mounted housing	Flange insert
Copper				
	RJ45 crimp	HDC RockStar® / Variant 5		RJ45 coupling
	RJ45 can be assembled on-site	Push-Pull / Variant 14		RJ45 Modul A, B, P
Fibre-optic				
		Bayonet / Variant 1, plastic		USB-A coupling
	2xSC	Bayonet / Variant 1, metal		2SC/SCRJ adapter
	LC duplex	Push-Pull / Variant 4		LC duplex adapter
		Push-Pull / Variant 14		

Take advantage of maximum flexibility! The range of products guarantees you significant advantages for your industrial applications - in planning, assembling and everyday operations. All variants are designed for IP 67 protection.

The Weidmüller products take account of the latest market conditions and most recent international standards. In doing so we offer you a limitless choice. What that means is that you get exactly the products you need for your application!

Features

- The only 8-core, on-site assembled, RJ45 connector for 10 Gigabit-Ethernet (Cat. 6_A / Class E_A).
- Larger cable sheath diameter range (up to 10 mm) for variants V4, V1, and V14. For V5 up to 12 mm.
- Suitable for connecting stranded conductors in sizes AWG 27/7 to AWG 22/7; solid conductors in sizes AWG 27/1 to 22/1.
- Modules and couplers have a robust diecast zinc housing.
- Design results in enhanced vibration and shock resistance for couplers and RJ45 modules.
- Variable bulkhead housing fixing options for variants V1 and V4.
- Additional marking surfaces on plug and bulkhead housing, subsequent colour coding of IP 20 and IP 67 plug-in connectors.
- Dirt-resistant housing design with enhanced resistance to oils, greases, acids and alkalis.

IE-LINE connectors: selection chart



Metal plug

Housings				Variant 1 Bayonet		Variant 14 PushPull RJ	Variant 14 PushPull fibre-optic	Var. 5 HDC
Inserts				With KS	Without KS	Without KS	Without KS	Without KS
				1962560000	1962550000	1011560000	1058100000	1962540000
	RJ45 AWG 24 crimp		1962720000	1963150000	1963140000	1012160000		1963110000
	RJ45 AWG 22 tool-free	TIA-A/-B/-P TIA-A TIA-B PROFINET	1962730000 1132010000 1132020000 1132030000	1963130000	1963120000	1012170000		1963200000 1271250000
	LWL SC	Multimode	1067380000	1963270000	1963260000		Please order separately	
		Singlemode	1067390000	1963310000	1963300000		Please order separately	
		PDF	1067410000				1191550000	
	LWL LC	Multimode	1962780000	1963230000	1963220000		Please order separately	
		Singlemode	1962790000	1963250000	1963240000		Please order separately	
	Protective cap			1965690000		1058280000	1058280000	1968920000

KS = anti-kink protection

Plastic plug

Housings				Variant 1 Bayonet		Variant 4 PushPull	
Inserts				With KS	Without KS	With KS	Without KS
				1012460000	1012440000	1962530000	1962520000
	RJ45 AWG 24 crimp		1962720000	1012560000	1012470000	1963190000	1963180000
	RJ45 AWG 22 tool-free	TIA-A/-B/-P TIA-A TIA-B PROFINET	1962730000 1132010000 1132020000 1132030000	1012570000	1012490000	1963170000	1963160000 1271240000
	LWL SC	Multimode	1067380000	Please order separately		1963370000	1963360000
		Singlemode	1067390000	Please order separately		1963410000	1963400000
	LWL LC	Multimode	1962780000	Please order separately		1963330000	1963320000
		Singlemode	1962790000	Please order separately		1963350000	1963340000
	Protective cap			1965690000		1963890000	

KS = anti-kink protection

Individual components
 Sets

V1 with SC multimode
1963260000



V5 with RJ45 crimp
1963110000



V4 with LC multimode
1063320000



V14 with RJ45 tool-free
1012170000





Metal flange

Housings				Variant 1 Bayonet	Variant 14 PushPull RJ		Variant 14 PushPull fibre-optic		Variant 5 HDC
Inserts				1963540000	1011540000	1047950000			1963530000
	RJ45 coupling		1962840000	1963470000	1012310000	1058250000			1963510000
	RJ45 module	TIA-A	1962850000	1963480000	1012320000	1058270000			1963460000
		TIA-B	1963840000	Please order separately	Please order separately	Please order separately			Please order separately
		PROFINET	1963830000	Please order separately	1085260000	Please order separately			1963700000
	SC/SCRJ coupling	Multimode	1964430000	1964450000			1058120000	1062590000	
		Singlemode	1962870000	1963440000			1058140000	1062600000	
	LC Duplex coupling	Multimode	1964420000	1964440000			1058130000	1062610000	
		Singlemode	1962880000	1963430000			1058150000	1062620000	
	USB coupling		1019570000	Please order separately	Please order separately	Please order separately			Please order separately
	Protective cap			1965700000	1058310000	1058310000	1058310000	1058310000	1968930000

Plastic flange

Housings				Variant 1 Bayonet	Variant 4 PushPull
Inserts				1016960000	1963520000
	RJ45 coupling		1962840000	1012370000	1963490000
	RJ45 module	TIA-A	1962850000	1012380000	1963500000
		TIA-B	1963840000	Please order separately	1963730000
		PROFINET	1963830000	Please order separately	Please order separately
	SC/SCRJ coupling	Multimode	1964430000	Please order separately	1964470000
		Singlemode	1962870000	Please order separately	1963420000
	LC Duplex coupling	Multimode	1964420000	Please order separately	1964460000
		Singlemode	1962880000	Please order separately	1963450000
	USB coupling		1019570000	Please order separately	Please order separately
	Protective cap			1965700000	1963900000

Individual components
 Sets

V5 with RJ45 coupling
1963510000



V1 with SC multimode
1964450000



V4 with LC multimode
1964460000

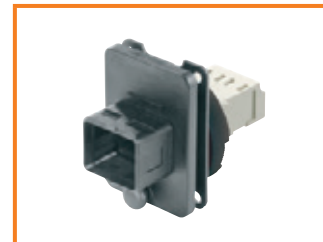

V14 with RJ45 module
1012320000



Customised cabling solutions for PROFINET and SERCOS III

Weidmüller’s cabling products enable you to create a specific infrastructure that meets all the requirements of PROFINET and SERCOS III.

The cabling components for copper and fibre-optic cables are designed and tested for use in harsh industrial conditions. Interoperability in the system is assured by the PROFINET and SERCOS cabling guidelines that specifically prescribe the interfaces to be used. For PROFINET this is guaranteed through the manufacturer’s declaration.

Comprehensive protection against disturbance by electromagnetic fields is achieved through the use of high quality shielding of the cables and the related connection components. Significant system reserves are offered through the star quad design of the cables and their wire cross-section of AWG 22. Stable real-time transmission is guaranteed, for applications such as PROFINET IRT or SERCOS III typical hardware synchronisation, by the low signal transmission time differences resulting from the cable construction. At the same time the cables offer high crush resistance for reliable installation in industrial applications.

The cabling components are also remarkably easy to handle when out in the field. The plug-in connectors for copper and fibre-optic can all be assembled on-site. This reduces installation time, reduces errors and simplifies maintenance.



Profile specific guidelines for the connection components

Cable:

- Quad-star design of AWG 22

Connector:

- IP 20 RJ45
- IP 20 SC-RJ
- IP 67 PushPull RJ45
- IP 67 PushPull Power
- IP 67 PushPull SC-RJ
- IP 67 M12 D-coding



Weidmüller offers you a wide range of cabling solutions for PROFINET and SERCOS III applications. IP 20 plug-in connectors for copper and fibre-optic cables are also included as well as IP 67 plug-in connectors and junction

boxes for the toughest requirements. The components are designed to be used together from the floor distributors down to the machines.

IP 67 assembled RJ45 cables



IP 67 assembled M12 cables



IP 67 plug-in M12 connectors



IP 67 connection components



Cable by the metre copper and fibre-optic

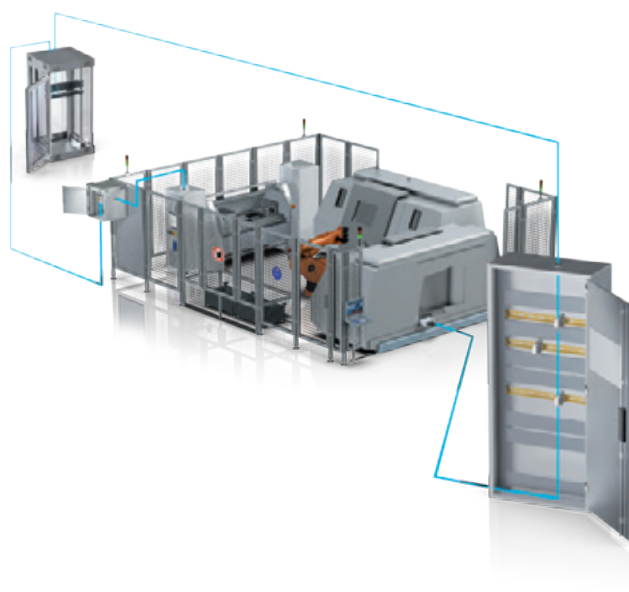

IP 67 plug-in connectors data / power



IP 67 flanges data / power



IP 20 plug-in connector

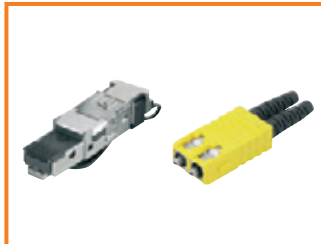

IP 20 assembled cables



IP 20 mounting rail outlets



IP 65 service interfaces



Selection table

Ideal combinations

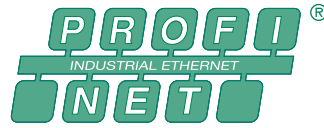

sercos
the automation bus

IP 20 plug-in connector



Description	Type	Order No.
RJ45 tool-free PROFINET printing	IE-PS-RJ45-FH-BK-P	1132060000
RJ45 tool-free angled Profinet printing	IE-PS-RJ45-FH-90-P-1.6	1518100000
SC-RJ for POF fibres 1 mm	IE-PS-SCRJ1-POF	1206720000
SC-RJ for multimode fibres 50/62.5 µm	IE-PS-SCRJ1-MM	1206730000
SC-RJ for singlemode fibres 9 µm	IE-PS-SCRJ1-SM	1206740000

IP 20 assembled data cables



Description	Type	Order No.
RJ45 patch cable PVC type B - 1 m	IE-C5DS4VG0010A60A60-E	1522100010
RJ45 patch cable PVC type B - 3 m	IE-C5DS4VG0030A60A60-E	1522100030
RJ45 patch cable PVC type B - 5 m	IE-C5DS4VG0050A60A60-E	1522100050
RJ45 patch cable PVC type B - 10 m	IE-C5DS4VG0100A60A60-E	1522100100
SC-RJ zipcord patch cable - POF - 1 m	IE-FPOZ2EE0001MSJOSJO-X	1273430010
SC-RJ zipcord patch cable - POF - 3 m	IE-FPOZ2EE0003MSJOSJO-X	1273430030
SC-RJ zipcord patch cable - POF - 5 m	IE-FPOZ2EE0005MSJOSJO-X	1273430050
SC-RJ zipcord patch cable - POF - 10 m	IE-FPOZ2EE0010MSJOSJO-X	1273430100

Further PROFINET cables - SERCOS III cables can be found in Chapter L

IP 20 mounting rail outlets



Description	Type	Order No.
RJ45 coupling	IE-TO-RJ45-C	8946920000
RJ45 module PROFINET printing	IE-TO-RJ45-FJ-P	8946950000
SC-RJ POF coupling / multimode	IE-TO-SCRJ-MM	8946990000
SC-RJ singlemode coupling	IE-TO-SCRJ-SM	8947000000

IP 65 service interface



Beschreibung	Type	Order No.
FrontCom® Micro RJ45 coupling	IE-FCM-RJ45-C	1018790000
FrontCom® Micro RJ45 module PROFINET printing	IE-FCM-RJ45-FJ-P	1018830000

IP 67 flange data



Description	Type	Order No.
PushPull standard flange RJ45 coupling	IE-BSS-V14M-RJ45-C	1012310000
PushPull central cable gland RJ45 coupling	IE-BSC-V14M-RJ45-C	1058250000
PushPull standardised flange RJ45 module PROFINET printing	IE-BSS-V14M-RJ45-FJ-P	1085260000
PushPull standardised flange hybrid (Q10) 10-pole module without contacts	IE-BSS-V14M-HYB-10P-FJ	1072900000
Contacts for Hybrid (Q10) module 0.5 mm ² - 0.75 mm ² VPE 300	IE-BIC-HYB-P-0,75-300	1068970000
Contacts for Hybrid (Q10) module 0.2 mm ² - 0.5 mm ² VPE 300	IE-BIC-HYB-P-0,5-300	1096150000
PushPull standardised flange SC-RJ coupling POF / multimode	IE-BSS-V14M-SCRJ-MM-C	1058120000
PushPull standardised flange SC-RJ coupling singlemode	IE-BSS-V14M-SCRJ-SM-C	1058140000
PushPull central cable gland SC-RJ coupling POF / multimode	IE-BSC-V14M-SCRJ-MM-C	1062590000
PushPull central cable gland SC-RJ coupling singlemode	IE-BSC-V14M-SCRJ-SM-C	1062600000
PushPull device flange	IE-BHD-V14M	1047940000
PushPull flange protective cap IP 67	IE-BP-V14P	1058310000

other inserts can be found in Chapter J

IP 67 Power connectors



Description	Type	Order No.
PushPull Power with 24 V / 16 A use	IE-PS-VAPM-24V	1068910000
PushPull Power with 400 V / 16 A use	IE-PS-VAPM-400V	1323940000

IP 67 flange power



Description	Type	Order No.
PushPull Power standardised flange with 24 V / 16 A use	IE-BSS-VAPM-24V	1069030000
PushPull Power standardised flange with 400 V / 16 A use	IE-BSS-VAPM-400V	1323950000
PushPull Power device flange	IE-BHD-VAPM	1068920000
PushPull Power flange protective cap IP 67	IE-BP-VAPP	1068930000

IP 67 data connectors

	Description	Type	Order No.
	PushPull RJ45 tool-free module PROFINET printing	IE-PS-V14M-RJ45-FH-P	1012170000
	PushPull Hybrid (Q10) use, 10-pole module without contacts	IE-PS-V14M-HYB-10P	1072910000
	Contacts for Hybrid (Q10) use 0.75 mm ² VPE 300	IE-PIC-HYB-S-0,75-300	1068950000
	Contacts for Hybrid (Q10) use 0.2 mm ² - 0.5 mm ² VPE 300	IE-PIC-HYB-S-0,5-300	1096180000
	PushPull SC-RJ use POF 1 mm	IE-PS-V14M-2SC-POF	1191550000
	PushPull plug protective cap IP 67	IE-PP-V14P	1058280000

IP 67 assembled data cables

	Description	Type	Order No.
	PushPull RJ45 patch cable PUR - Type C - 1 m	IE-C5DD4UG0010A2EA2E-X	1119730010
	PushPull RJ45 patch cable PUR - Type C - 3 m	IE-C5DD4UG0030A2EA2E-X	1119730030
	PushPull RJ45 patch cable PUR - Type C - 5 m	IE-C5DD4UG0050A2EA2E-X	1119730050
	PushPull RJ45 patch cable PUR - Type C - 10 m	IE-C5DD4UG0100A2EA2E-X	1119730100
Further PROFINET cables - SERCOS III cables can be found in Chapter L			

IP 67 plug connector M12 D-coded and X-Type

M 12 components can be found in Chapter J

IP 65 connection components

	Description	Type	Order No.
	FreeCon passive double junction box RJ45/Power	IE-CD-V14MRJ/VAPM24V-FJ	1068830000
	FreeCon passive single junction box RJ45	IE-CD-V14MRJ-FJ	1068880000
	FreeCon passive single junction box Hybrid (Q10) without contacts	IE-CD-V14MHYB-10P-FJ	1068850000
	Contacts for Hybrid (Q10) module 0.75 mm ² VPE 300	IE-BIC-HYB-P-0,75-300	1068970000
	Contacts for Hybrid (Q10) module 0.2 mm ² - 0.5 mm ² VPE 300	IE-BIC-HYB-P-0,5-300	1096150000
	Mounting foot for junction boxes	IE-CD-MA	1099580000
	FreeCon passive double coupling RJ45/Power	IE-CD-V14MRJ/VAPM24V-C-MA	1068820000
	FreeCon passive single coupling RJ45	IE-CD-V14MRJ-C-MA	1068870000
	FreeCon passive single coupling hybrid (Q10)	IE-CD-V14MHYB-10P-C-MA	1068840000
	FreeCon PushPull Power Y-distributor	IE-CD-VAPM24V-Y-MA	1297010000
	FreeCon PushPull Power single coupling	IE-CD-VAPM24V-C-MA	1397690000
	FreeCon passive single coupling SCRJ	IE-CD-V14MSCRJ-MM-C-MA	1318150000
	FreeCon active FO PROFINET repeater	IE-CDR-V14MSCPOF/VAPM-C	1253240000
	FreeCon active PROFINET media converter	IE-CDM-V14MRJSCP/VAPM-C	1324440000
	PushPull flange protective cap IP 67	IE-BP-V14P	1058310000
	FreeCon passive cable coupling RJ45	IE-CC-V14M-RJ45-FJ-P	1990600000
	FreeCon passive cable coupling hybrid	IE-CC-V14M-HYB-10P-FJ	1990610000
	Mounting frame FreeCon cable coupling RJ45 / hybrid	IE-CC-V14M-MF	1990620000
	FreeCon passive cable coupling power	IE-CC-VAPM-24V	1990630000
	Mounting frame FreeCon cable coupling power	IE-CC-VAPM-MF	1990640000

Bulk stock copper cable

	Description	Type	Order No.
	100 m ring installation cable PVC type A	IE-C5AS4V1000	8899000000
	Bulk stock installation cable PVC type A from 110 m	IE-C5AS4VG-MW	8955950000
	100 m ring connection cable PVC type B	IE-C5DS4V1000	8898990000
	Bulk stock connection cable PVC type B from 110 m	IE-C5DS4VG-MW	8955660000
	100 m ring dragline cable PUR type C	IE-C5DD4U1000	8899010000
	Bulk stock dragline cable PUR type C from 110 m	IE-C5DD4UG-MW	8947670000
	Torsion cable PUR type C available by the metre from 110 m	IE-C5I14UG-MW	1103010000
	Bulk stock hybrid cable PVC from 110 m	IE-C5DHAG-MW	1172250000

Bulk stock fibre-optic cable

	Description	Type	Order No.
	Multimode breakout cable 2x50 µm PUR from 50 m	IE-FM5B2UE-MW	8946000000
	POF zip-cord cable 2X980/1000 µm TPE, from 50 m	IE-FPOZ2EE-MW	1242820000
	POF breakout cable 2X980/1000 µm TPE, from 50 m	IE-FPOD2UE-MW	1172280000

Customised cabling solutions for Ethernet/IP

The wiring guidelines for EtherNet/IP clearly define the interfaces to be used to ensure interoperability in EtherNet/IP systems.

Weidmüller offers all the cabling products needed to build a requirement specific infrastructure which is tailored to the needs of EtherNet/IP.

The wiring components for copper and fibre-optic cables are designed and tested for use in harsh industrial environments. The user is provided with clear guidelines about the requirements of the components for use in industrial environments with the introduction of the MICE classification (EtherNet/IP Media Planning and Installation Manual).

The high-quality shielding of the cables and connection components offers comprehensive protection against electromagnetic interference.

The cables are 8-wire twisted-pair cables for RJ45 or star quad for use in M12.

The cabling components are also easy to handle in the field. The plug-in connectors for copper and fibre optic cables can all be assembled on-site. This reduces installation time, reduces errors and simplifies maintenance.

The connectors wire/pin assignment is either according to TIA568-A or TIA568-B as required. The connectors and modules are marked accordingly, making them easier to connect.



Profile specific guidelines for the connection components

Cable:

- 8-wire twisted-pair shielded cables

Connector:

- IP 20 RJ45
- IP 20 SC-RJ
- IP 67 bayonet RJ45
- IP 67 bayonet SC-RJ
- IP 67 M12 D-coding

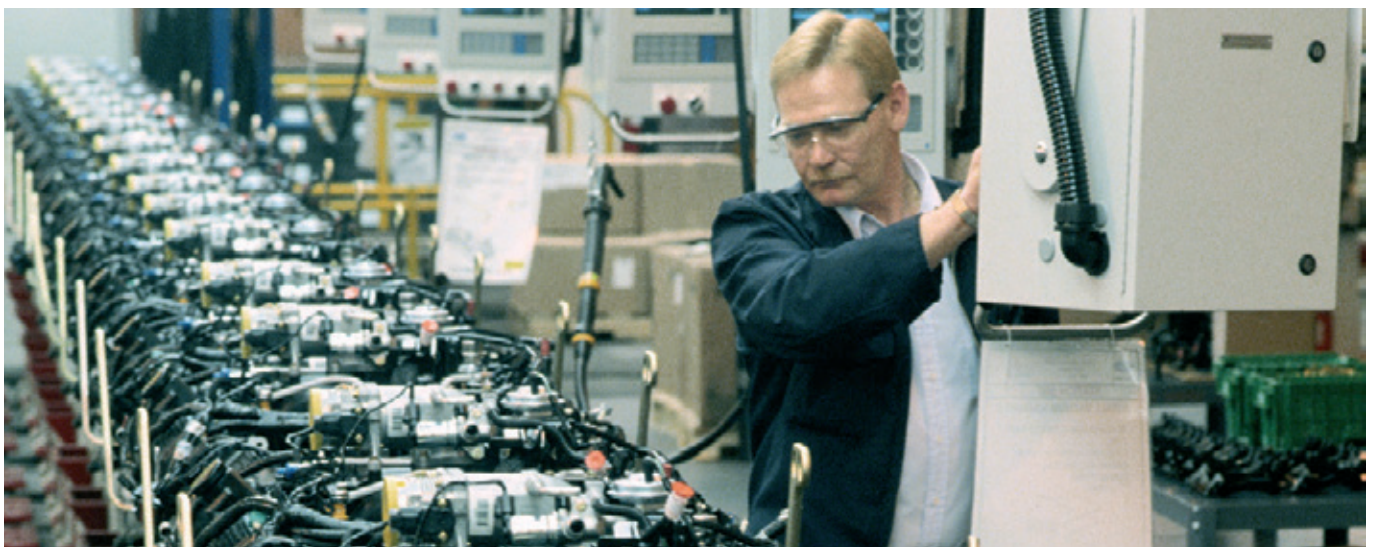

Weidmüller offers you a wide range of cabling solutions for EtherNet/IP applications. IP 20 plug-in connectors for copper and fibre-optic cables are available, as well as IP 67 connectors and junction boxes for the most exacting

requirements. The components are designed to be used together from the floor distributors down to the machines.

IP 67
assembled RJ45 cables



IP 67
assembled M12 cables



IP 67
plug-in M12 connectors



IP 67
connection components



Cable by the metre
copper and fibre-optic

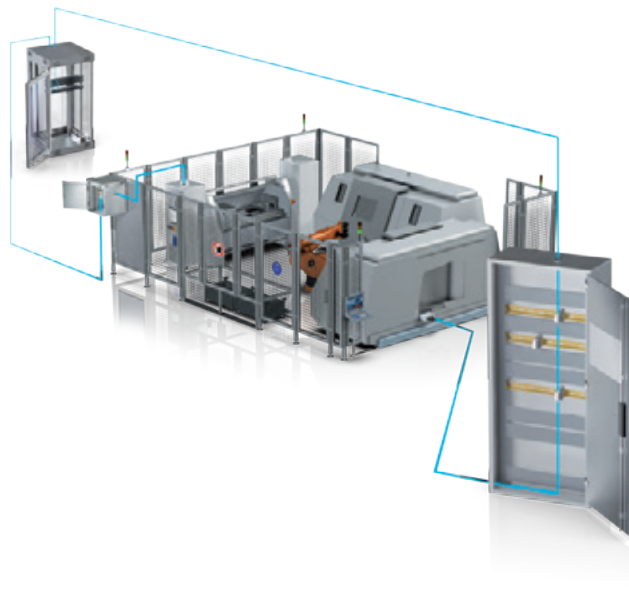

IP 67
plug-in connectors data



IP 67
flanges data / power



IP 20
plug-in connector



IP 20
assembled cables



IP 20
mounting rail outlets



IP 65
service interfaces



Selection table

Ideal combinations for a perfect fit



IP 20 plug-in connector

	Description	Type	Order No.
	RJ45 crimp	IE-PS-RJ45-TH-BK	1963590000
	RJ45 tool-free TIA-A printing	IE-PS-RJ45-FH-BK-A	1132040000
	RJ45 tool-free TIA-B printing	IE-PS-RJ45-FH-BK-B	1132050000
	SC-RJ for 1 mm POF fibres	IE-PS-SCRJ1-POF	1206720000
	SC-RJ for multimode fibres 50/62.5 µm	IE-PS-SCRJ1-MM	1206730000
	SC-RJ for singlemode fibres 9 µm	IE-PS-SCRJ1-SM	1206740000

IP 20 assembled data cables

	Description	Type	Order No.
	RJ45 patch cables - see CabinetLine		
	SC-RJ zipcord patch cable - POF - 1 m	IE-FPOZ2EE0001MSJOSJO-X	1273430010
	SC-RJ zipcord patch cable - POF - 3 m	IE-FPOZ2EE0003MSJOSJO-X	1273430030
	SC-RJ zipcord patch cable - POF - 5 m	IE-FPOZ2EE0005MSJOSJO-X	1273430050
	SC-RJ zipcord patch cable - POF - 10 m	IE-FPOZ2EE0010MSJOSJO-X	1273430100
Other EtherNet/IP cables available on request			

IP 20 mounting rail outlets

	Description	Type	Order No.
	RJ45 coupling	IE-TO-RJ45-C	8946920000
	RJ45 Module TIA-A printing	IE-TO-RJ45-FJA	8946930000
	RJ45 Module TIA-B printing	IE-TO-RJ45-FJB	8946940000
	SC-RJ POF coupling / multimode	IE-TO-SCRJ-MM	8946990000
	SC-RJ singlemode coupling	IE-TO-SCRJ-SM	8947000000

IP 65 service interface

	Description	Type	Order No.
	FrontCom® Micro RJ45 coupling	IE-FCM-RJ45-C	1018790000
	FrontCom® Micro RJ45 module TIA-A printing	IE-FCM-RJ45-FJA	1018810000
	FrontCom® Micro RJ45 module TIA-B printing	IE-FCM-RJ45-FJB	1018820000

IP 67 flange data

	Description	Type	Order No.
	Bayonet flange metal RJ45 coupling	IE-BS-V01M-RJ45-C	1963470000
	Bayonet flange metal RJ45 module TIA-A printing	IE-BS-V01M-RJ45-FJA	1963480000
	Bayonet flange plastic RJ45 coupling	IE-BS-V01P-RJ45-C	1012370000
	Bayonet flange metal RJ45 module TIA-A printing	IE-BS-V01P-RJ45-FJA	1012380000
	Bayonet flange metal SCRJ POF / multimode	IE-BS-V01M-SCRJ-MM	1221010000
	Bayonet flange metal SCRJ singlemode	IE-BS-V01M-SCRJ-SM	1221020000
	Bayonet flange protective cap IP 67	IE-BP-V01P	1965700000
	Other inserts can be found in Chapter J		

IP 67 data connectors

	Description	Type	Order No.
	Bayonet plug metal RJ45 crimped	IE-PS-V01M-RJ45-TH	1963140000
	Bayonet plug metal RJ45 tool-free	IE-PS-V01M-RJ45-FH	1963120000
	Bayonet plug plastic RJ45 crimped	IE-PS-V01P-RJ45-TH	1012470000
	Bayonet plug plastic RJ45 tool-free	IE-PS-V01P-RJ45-FH	1012490000
	Bayonet plug metal SCRJ use POF	IE-PS-V01M-2SC-POF	1963280000
	Bayonet plug metal SCRJ use multimode	IE-PS-V01M-2SC-MM	1963260000
	Bayonet plug metal SCRJ use singlemode	IE-PS-V01M-2SC-SM	1963300000
	Bayonet plug protective cap IP 67	IE-PP-V01P	1965690000

IP 67 assembled data cables



Description	Type	Order No.
Bayonet metal RJ45 patch cable PUR 1 m	IE-C5ES8UG0010B41B41-E	1066850000
Bayonet metal RJ45 patch cable PUR 2 m	IE-C5ES8UG0020B41B41-E	1066860000
Bayonet metal RJ45 patch cable PUR 5 m	IE-C5ES8UG0050B41B41-E	1066870000
Bayonet metal RJ45 patch cable PUR 10 m	IE-C5ES8UG0100B41B41-E	1066880000
Bayonet plastic RJ45 patch cable PUR 1 m	IE-C5ES8UG0010P41P41-E	1106010000
Bayonet plastic RJ45 patch cable PUR 2 m	IE-C5ES8UG0020P41P41-E	1106020000
Bayonet plastic RJ45 patch cable PUR 5 m	IE-C5ES8UG0050P41P41-E	1106030000
Bayonet plastic RJ45 patch cable PUR 10 m	IE-C5ES8UG0100P41P41-E	1106040000

Other EtherNet/IP cables available on request

IP 67 plug-in M12 connectors

M 12 components can be found in Chapter J

IP 65 connection components



Description	Type	Order No.
Single junction box, plastic	IE-OP-V01P-1S	1061830000
Plastic cable coupling	IE-CC-V01P	1061820000
RJ45 module TIA-A printing	IE-BI-RJ45-FJA	1962850000
RJ45 module TIA-B printing	IE-BI-RJ45-FJB	1963840000

Bulk stock copper cable



Description	Type	Order No.
100 m ring installation cable PVC Cat. 5 SF/UTP	IE-5IC4x2xAWG24/1-PVC	8813150000
Bulk stock installation cable PVC Cat. 5 SF/UTP from 110 m	IE-C5CS8VG-MW	8953160000
100 m ring installation cable PUR Cat. 5 SF/UTP	IE-5IC4x2xAWG24/1-PUR	8813160000
Bulk stock installation cable PUR Cat. 5 SF/UTP from 110 m	IE-C5CS8UG-MW	8944310000
100 m ring connection cable PVC Cat. 5 SF/UTP	IE-5CC4x2xAWG26/7-PVC	8813190000
Bulk stock connection cable PVC Cat. 5 SF/UTP from 110 m	IE-C5ES8VG-MW	8955490000
100 m ring connection cable PUR Cat. 5 SF/UTP	IE-5CC4x2xAWG26/7-PUR	8813200000
Bulk stock connection cable PUR Cat. 5 SF/UTP from 110 m	IE-C5ES8UG-MW	8938880000

Other EtherNet/IP cables available on request

Bulk stock fibre-optic cable



Description	Type	Order No.
Multimode breakout cable 2x50 µm PUR from 50 m	IE-FM5B2UE-MW	8946000000
POF zip-cord cable 2X980/1000 µm TPE, from 50 m	IE-FPOZ2EE-MW	1242820000
POF breakout cable 2X980/1000 µm TPE, from 50 m	IE-FPOD2UE-MW	1172280000

IP 20 plug-in connectors and mounting rail outlets

Overview

IP 20 plug-in connectors and mounting rail outlets	IP 20 plug-in connectors	RJ45 Plug	H.2
		FO Connector	H.7
		Coupling BNC	H.9
	RJ45 PCB socket	H.10	
	IP 20 mounting rail outlets	RJ45	H.15
		USB	H.18
		FO	H.19

RJ45 plug, tool free

- Cat. 6_A (8-wire) / Cat. 5 (4-wire) for PROFINET
- Multiprot-compatible
- IP 20

8-wire

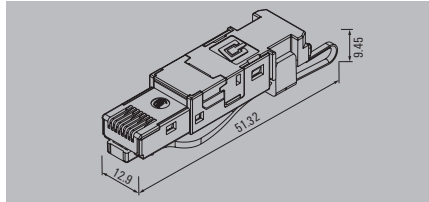

4-wire for PROFINET

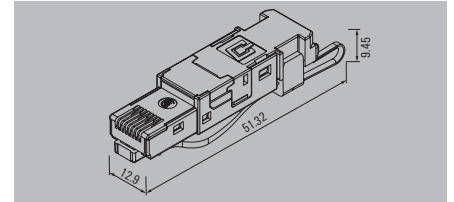

Technical data

Category
Protection degree
Housing main material
Connection diameter, flexible, min. / max.
Connection cross-section, flexible, min. / max.
Connection diameter, solid, min. / max.
Connection cross-section, solid, min. / max.
Wire connection cross-section, finely stranded
Insulation diameter, min. / max.
Sheath diameter, min. / max.
Contact surface
Shielding
Plugging cycles
Ambient temperature (operational)
Contact resistance
Insulation resistance
Dielectric strength, contact / contact
Dielectric strength, contact / shield
Connector standard
Current-carrying capacity at 50 °C
Speed
PoE / PoE+
Approvals
Note

Cat.6 _A / Class E _A (ISO/IEC 11801 2010)
IP 20
Zinc diecast
0.48 mm / 0.76 mm
AWG 26 / AWG 22
0.4 mm / 0.64 mm
AWG 24 / AWG 22
Approval of the cable by Weidmüller necessary
0.85 mm / 1.6 mm
5.5 mm / 8.5 mm
Gold over nickel
360° all-round enclosure
750
-40 °C...70 °C
≤ 20 mΩ
> 500 MΩ
≥ 1000 V DC
≥ 1500 V DC
IEC 60603-7-51
1 A
10 GBit/s
conforming to IEEE 802.3at
CULUS; EAC
Approvals available on request

Cat.5 (ISO/IEC 11801)
IP 20
Zinc diecast
0.48 mm / 0.76 mm
AWG 26 / AWG 22
0.4 mm / 0.64 mm
AWG 24 / AWG 22
Approval of the cable by Weidmüller necessary
0.85 mm / 1.6 mm
5.5 mm / 8.5 mm
Gold over nickel
360° all-round enclosure
750
-40 °C...70 °C
≤ 20 mΩ
> 500 MΩ
≥ 1000 V DC
≥ 1500 V DC
IEC 60603-7-51
1 A
100 GBit/s
conforming to IEEE 802.3at
CULUS; EAC







Ordering data

Plug	
	with tear-off flags: EIA / TIA 568-A/B/PROFINET
	with printing: PROFINET
	with printing: EIA / TIA 568-A
	with printing: EIA/TIA 568-B
Note	

Type	Qty.	Order No.
IE-PS-RJ45-FH-BK	10	1963600000
IE-PS-RJ45-FH-BK-A	10	1132040000
IE-PS-RJ45-FH-BK-B	10	1132050000

Type	Qty.	Order No.
IE-PS-RJ45-FH-BK-P	10	1132060000

Accessories

Strain relief	
	green
	grey
	blue
	orange
	yellow
	white
Tools	
	Optional pressing tool
Note	

Type	Qty.	Order No.
IE-CR-IP20-RJ45-FH-GN	10	1963100000
IE-CR-IP20-RJ45-FH-GY	10	1963060000
IE-CR-IP20-RJ45-FH-BU	10	1963080000
IE-CR-IP20-RJ45-FH-OG	10	1963070000
IE-CR-IP20-RJ45-FH-YE	10	1963090000
IE-CR-IP20-RJ45-FH-WH	10	1963050000
PWZ RJ45	1	1118040000

Type	Qty.	Order No.
IE-CR-IP20-RJ45-FH-GN	10	1963100000
IE-CR-IP20-RJ45-FH-GY	10	1963060000
IE-CR-IP20-RJ45-FH-BU	10	1963080000
IE-CR-IP20-RJ45-FH-OG	10	1963070000
IE-CR-IP20-RJ45-FH-YE	10	1963090000
IE-CR-IP20-RJ45-FH-WH	10	1963050000
PWZ RJ45	1	1118040000

RJ45 plug, straight, tool free

- Fieldattachable
- Cat. 6_A (8-wire)
- Multi-port-compatible
- IP 20

8-wire, insulation diameter 1 - 1.6 mm

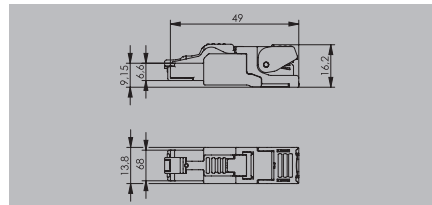

8-wire, insulation diameter 0.85 - 1.1 mm

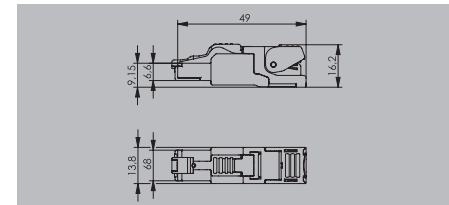

Technical data

Category	Cat.6 _A / Class E _A (ISO/IEC 11801 2010)
Protection degree	IP 20
Housing main material	Zinc diecast, nickel-plated
Connection diameter, flexible, min. / max.	0.46 mm / 0.76 mm
Connection cross-section, flexible, min. / max.	AWG 27 / AWG 22
Connection diameter, solid, min. / max.	0.51 mm / 0.64 mm
Connection cross-section, solid, min. / max.	AWG 24 / AWG 22
Connection diameter, very finely stranded, min./max.	0.61 mm / 0.78 mm / Approval of the cable by Weidmüller necessary
Connection cross-section, very finely stranded, min./max.	AWG 24 / AWG 22 / Approval of the cable by Weidmüller necessary
Insulation diameter, min. / max.	1 mm / 1.6 mm
Sheath diameter, min. / max.	5 mm / 9 mm
Contact surface	Gold over nickel
Shielding	360° all-round enclosure
Plugging cycles	750
Ambient temperature (operational)	-40 °C...85 °C
Contact resistance	≤ 20 mΩ
Insulation resistance	> 500 MΩ
Dielectric strength, contact / contact	≥ 1000 V DC
Dielectric strength, contact / shield	≥ 1500 V DC
Connector standard	IEC 60603-7-51
Current-carrying capacity at 50 °C	1 A
Speed	10 GBit
PoE / PoE+	conforming to IEEE 802.3at
Approvals	CULUS

Note

Category	Cat.6 _A / Class E _A (ISO/IEC 11801 2010)
Protection degree	IP 20
Housing main material	Zinc diecast, nickel-plated
Connection diameter, flexible, min. / max.	0.46 mm / 0.61 mm
Connection cross-section, flexible, min. / max.	AWG 27 / AWG 24
Connection diameter, solid, min. / max.	0.41 mm / 0.51 mm
Connection cross-section, solid, min. / max.	AWG 26 / AWG 24
Connection diameter, very finely stranded, min./max.	0.51 mm / / Approval of the cable by Weidmüller necessary
Connection cross-section, very finely stranded, min./max.	AWG 26 / / Approval of the cable by Weidmüller necessary
Insulation diameter, min. / max.	0.85 mm / 1.1 mm
Sheath diameter, min. / max.	5 mm / 9 mm
Contact surface	Gold over nickel
Shielding	360° all-round enclosure
Plugging cycles	750
Ambient temperature (operational)	-40 °C...85 °C
Contact resistance	≤ 20 mΩ
Insulation resistance	> 500 MΩ
Dielectric strength, contact / contact	≥ 1000 V DC
Dielectric strength, contact / shield	≥ 1500 V DC
Connector standard	IEC 60603-7-51
Current-carrying capacity at 50 °C	1 A
Speed	10 GBit
PoE / PoE+	conforming to IEEE 802.3at
Approvals	CULUS

Category	Cat.6 _A / Class E _A (ISO/IEC 11801 2010)
Protection degree	IP 20
Housing main material	Zinc diecast, nickel-plated
Connection diameter, flexible, min. / max.	0.46 mm / 0.61 mm
Connection cross-section, flexible, min. / max.	AWG 27 / AWG 24
Connection diameter, solid, min. / max.	0.41 mm / 0.51 mm
Connection cross-section, solid, min. / max.	AWG 26 / AWG 24
Connection diameter, very finely stranded, min./max.	0.51 mm / / Approval of the cable by Weidmüller necessary
Connection cross-section, very finely stranded, min./max.	AWG 26 / / Approval of the cable by Weidmüller necessary
Insulation diameter, min. / max.	0.85 mm / 1.1 mm
Sheath diameter, min. / max.	5 mm / 9 mm
Contact surface	Gold over nickel
Shielding	360° all-round enclosure
Plugging cycles	750
Ambient temperature (operational)	-40 °C...85 °C
Contact resistance	≤ 20 mΩ
Insulation resistance	> 500 MΩ
Dielectric strength, contact / contact	≥ 1000 V DC
Dielectric strength, contact / shield	≥ 1500 V DC
Connector standard	IEC 60603-7-51
Current-carrying capacity at 50 °C	1 A
Speed	10 GBit
PoE / PoE+	conforming to IEEE 802.3at
Approvals	CULUS

Ordering data

Plug	
	with printing: EIA / TIA 568-A
	with printing: EIA/TIA 568-B

Note

Type	Qty.	Order No.
IE-PS-RJ45-FH-180-A-1.6	1	1992820000
IE-PS-RJ45-FH-180-B-1.6	1	1992830000

With pre-installed dust cap

Type	Qty.	Order No.
IE-PS-RJ45-FH-180-A-1.1	1	1992850000
IE-PS-RJ45-FH-180-B-1.1	1	1992860000

With pre-installed dust cap

Accessories

Substitute wire manager	
TIA-A, insulation cross-section 1...1.6 mm	
TIA-B, insulation cross-section 1...1.6 mm	
TIA-A, insulation cross-section 0.85...1 mm	
TIA-B, insulation cross-section 0.85...1 mm	

Tools



Optional pressing tool

Type	Qty.	Order No.
IE-PI-RJ45-FH-A-1.6	30	1992880000
IE-PI-RJ45-FH-B-1.6	30	1992900000

Type	Qty.	Order No.
PWZ RJ45	1	1118040000

Type	Qty.	Order No.
IE-PI-RJ45-FH-A-1.1	30	1992920000
IE-PI-RJ45-FH-B-1.1	30	1992930000

Type	Qty.	Order No.
PWZ RJ45	1	1118040000

Note

IP 20 plug-in connectors

RJ45 plug, angled, tool free

- Fieldattachable
- Cat. 6_A (8-wire)
- Multi-port-compatible
- IP 20

8-wire, insulation diameter 1 - 1.6 mm

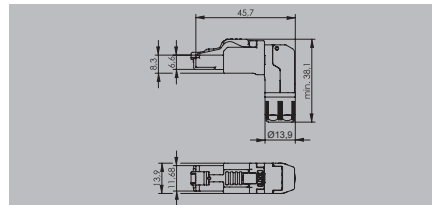

8-wire, insulation diameter 0.85 - 1.1 mm

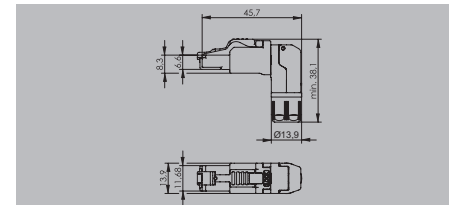

Technical data

Category
Protection degree
Housing main material
Connection diameter, flexible, min. / max.
Connection cross-section, flexible, min. / max.
Connection diameter, solid, min. / max.
Connection cross-section, solid, min. / max.
Connection diameter, very finely stranded, min./max.

Connection cross-section, very finely stranded, min./max.

Insulation diameter, min. / max.
Sheath diameter, min. / max.
Contact surface
Shielding
Plugging cycles
Ambient temperature (operational)
Contact resistance
Insulation resistance
Dielectric strength, contact / contact
Dielectric strength, contact / shield
Connector standard
Current-carrying capacity at 50 °C
Speed
PoE / PoE+
Approvals

Note

Cat.6_A / Class E_A (ISO/IEC 11801 2010)
IP 20
Zinc diecast, nickel-plated
0.46 mm / 0.76 mm
AWG 27 / AWG 22
0.51 mm / 0.64 mm
AWG 24 / AWG 22
0.61 mm / 0.78 mm / Approval of the cable by Weidmüller necessary

AWG 24 / AWG 22 / Approval of the cable by Weidmüller necessary

1 mm / 1.6 mm
5 mm / 9 mm
Gold over nickel
360° all-round enclosure
750
-40 °C...85 °C
≤ 20 mΩ
> 500 MΩ
≥ 1000 V DC
≥ 1500 V DC
IEC 60603-7-51
1 A
10 GBit
conforming to IEEE 802.3at
CULUS

Cat.6_A / Class E_A (ISO/IEC 11801 2010)
IP 20
Zinc diecast, nickel-plated
0.46 mm / 0.61 mm
AWG 27 / AWG 24
0.41 mm / 0.51 mm
AWG 26 / AWG 24
0.51 mm / / Approval of the cable by Weidmüller necessary

AWG 26 / / Approval of the cable by Weidmüller necessary

0.85 mm / 1.1 mm
5 mm / 9 mm
Gold over nickel
360° all-round enclosure
750
-40 °C...85 °C
≤ 20 mΩ
> 500 MΩ
≥ 1000 V DC
≥ 1500 V DC
IEC 60603-7-51
1 A
10 GBit
conforming to IEEE 802.3at
CULUS

Ordering data

Plug	
	with printing: EIA / TIA 568-A
	with printing: EIA/TIA 568-B

Note

Type	Qty.	Order No.
IE-PS-RJ45-FH-90-A-1.6	1	1992870000
IE-PS-RJ45-FH-90-B-1.6	1	1992890000

With pre-installed dust cap

Type	Qty.	Order No.
IE-PS-RJ45-FH-90-A-1.1	10	1518080000
IE-PS-RJ45-FH-90-B-1.1	10	1518090000

With pre-installed dust cap

Accessories

Substitute wire manager	
TIA-A, insulation cross-section 1...1.6 mm	
TIA-B, insulation cross-section 1...1.6 mm	
TIA-A, insulation cross-section 0.85...1 mm	
TIA-B, insulation cross-section 0.85...1 mm	

Tools



Optional pressing tool

Type	Qty.	Order No.
IE-PI-RJ45-FH-A-1.6	30	1992880000
IE-PI-RJ45-FH-B-1.6	30	1992900000

Type	Qty.	Order No.
PWZ RJ45	1	1118040000

Type	Qty.	Order No.
IE-PI-RJ45-FH-A-1.1	30	1992920000
IE-PI-RJ45-FH-B-1.1	30	1992930000

Type	Qty.	Order No.
PWZ RJ45	1	1118040000

Note

RJ45 plug, straight and angled, tool free

- Fieldattachable
- Cat. 5 (4-wire) for PROFINET
- Multi-port-compatible
- IP 20

4-wire for PROFINET

straight

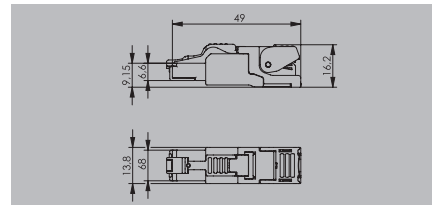

4-wire for PROFINET

angled

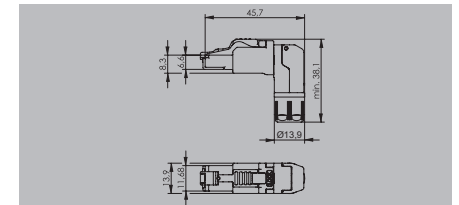

Technical data

Category
Protection degree
Housing main material
Connection diameter, flexible, min. / max.
Connection cross-section, flexible, min. / max.
Connection diameter, solid, min. / max.
Connection cross-section, solid, min. / max.
Connection diameter, very finely stranded, min./max.

Cat.5 (ISO/IEC 11801)
IP 20
Zinc diecast, nickel-plated
0.46 mm / 0.76 mm
AWG 27 / AWG 22
0.51 mm / 0.64 mm
AWG 24 / AWG 22
0.61 mm / 0.78 mm / Approval of the cable by Weidmüller necessary

Cat.5 (ISO/IEC 11801)
IP 20
Zinc diecast, nickel-plated
0.46 mm / 0.76 mm
AWG 27 / AWG 22
0.51 mm / 0.64 mm
AWG 24 / AWG 22
0.61 mm / 0.78 mm / Approval of the cable by Weidmüller necessary

Connection cross-section, very finely stranded, min./max.

AWG 24 / AWG 22 / Approval of the cable by Weidmüller necessary

AWG 24 / AWG 22 / Approval of the cable by Weidmüller necessary

Insulation diameter, min. / max.
Sheath diameter, min. / max.
Contact surface
Shielding
Plugging cycles
Ambient temperature (operational)
Contact resistance
Insulation resistance
Dielectric strength, contact / contact
Dielectric strength, contact / shield
Connector standard
Current-carrying capacity at 50 °C
Speed
PoE / PoE+
Approvals

1 mm / 1.6 mm
5 mm / 9 mm
Gold over nickel
360° all-round enclosure
750
-40 °C...85 °C
≤ 20 mΩ
> 500 MΩ
≥ 1000 V DC
≥ 1500 V DC
IEC 60603-7-51
1 A
100 Mbit
conforming to IEEE 802.3at
CULUS

1 mm / 1.6 mm
5 mm / 9 mm
Gold over nickel
360° all-round enclosure
750
-40 °C...85 °C
≤ 20 mΩ
> 500 MΩ
≥ 1000 V DC
≥ 1500 V DC
IEC 60603-7-51
1 A
100 Mbit
conforming to IEEE 802.3at
CULUS

Note

Ordering data

Plug with printing: PROFINET

Note

Type	Qty.	Order No.
IE-PS-RJ45-FH-180-P-1.6	1	1992840000
With pre-installed dust cap		

Type	Qty.	Order No.
IE-PS-RJ45-FH-90-P-1.6	10	1518100000
With pre-installed dust cap		

Accessories

Substitute wire manager
PROFINET, insulation cross-section 1...1.6 mm

Tools



Optional pressing tool

Type	Qty.	Order No.
IE-PI-RJ45-FH-P-1.6	30	1992910000
PWZ RJ45	1	1118040000

Type	Qty.	Order No.
IE-PI-RJ45-FH-P-1.6	30	1992910000
PWZ RJ45	1	1118040000

Note

RJ45 crimp plug

- Cat. 6
- With kink protection
- With locking-lever protection

8-wire, housing 1-part

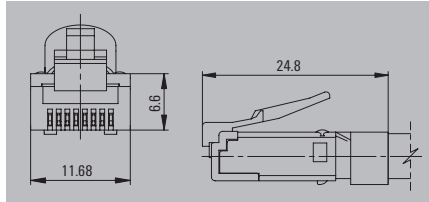

8-wire, housing 2-part

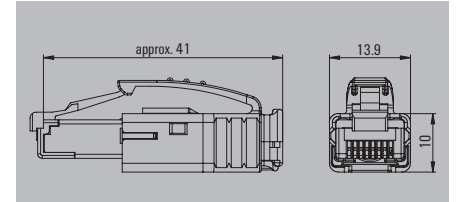

Technical data

Category
Protection degree
Connection diameter, flexible, min. / max.
Connection cross-section, flexible, min. / max.
Connection diameter, solid, min. / max.
Connection cross-section, solid, min. / max.
Insulation cross-section, max.
Sheath diameter, min. / max.
Shielding
Plugging cycles
Ambient temperature (operational)
Connector standard
Bending protection sleeve material
Material insulator
Contact material / Contact surface
Shielding material
Cable pull-out force, min.
Contact resistance
Insulation resistance
Dielectric strength, contact / contact
Dielectric strength, contact / shield
Current-carrying capacity at 50 °C
PoE / PoE+
Approvals

Cat.6 _n / Class E _n (ISO/IEC 11801 2010)
IP 20
0.46 mm / 0.61 mm
AWG 27 / AWG 24
0.36 mm / 0.51 mm
AWG 27 / AWG 24
1.05 mm
5.5 mm / 6.2 mm
360° all-round enclosure
750
-40 °C...70 °C
IEC 60603-7-51
Polyamide PA6, UL 94-V0
Polycarbonate PC, UL 94 V-0
Phosphorus bronze / Gold-plated
0.5 mm brass, 2 µm nickel
89 N
≤ 20 mΩ
500 MΩ
≤ 1000 V DC
≤ 1500 V DC
1 A
conforming to IEEE 802.3af
EAC

Cat.6 _n / Class E _n (ISO/IEC 11801 2010)
IP 20
0.46 mm / 0.61 mm
AWG 27 / AWG 24
0.36 mm / 0.51 mm
AWG 27 / AWG 24
1.05 mm
5 mm / 7.3 mm
360° all-round enclosure
750
-40 °C...70 °C
IEC 60603-7-51
Polycarbonate PC, UL 94 V-0
Polycarbonate PC, UL 94 V-0
Phosphorus bronze / Gold-plated
0.5 mm brass, 2 µm nickel
89 N
≤ 20 mΩ
500 MΩ
≤ 1000 V DC
≤ 1500 V DC
1 A
conforming to IEEE 802.3af
CURUS, EAC

Note

Ordering data

Plug	
	with kink prevention; 5.5 - 6.2 mm
	with kink prevention; 6.2 - 7.1 mm
	with kink prevention sleeve, black
	without kink prevention sleeve

Note

Type	Qty.	Order No.
IE-P63	10	8813110000
IE-P70	10	8813120000
IE-P	100	8813100000

Type	Qty.	Order No.
IE-PS-RJ45-TH-BK	10	1963590000
IE-PM-RJ45-TH	100	1963580000

Accessories

Kink prevention sleeve	
white	
green	
grey	
yellow	
orange	
black	
blue	



Tools	
	Crimping tool

Note

Type	Qty.	Order No.
TT 8 RS MP 8	1	9202800000

Type	Qty.	Order No.
IE-PH-RJ45-TH-WH	10	1962430000
IE-PH-RJ45-TH-GN	10	1962490000
IE-PH-RJ45-TH-GY	10	1962440000
IE-PH-RJ45-TH-YE	10	1962480000
IE-PH-RJ45-TH-OG	10	1962450000
IE-PH-RJ45-TH-BK	10	1962500000
IE-PH-RJ45-TH-BU	10	1962470000
TT 8 RS MP 8	1	9202800000

FO connector

- IP 20

SC-RJ

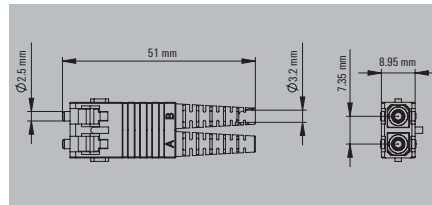

ST

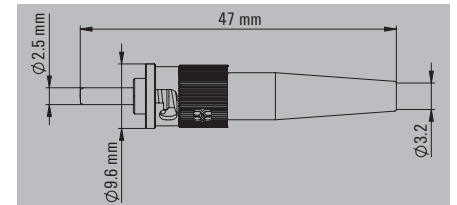

Technical data

Protection degree
 Plugging cycles
 Ambient temperature (operational)
 Connector standard
 Individual wire diameter, min. / max.
 Crimp barrel material
 Pressure spring material
 Ferrule material
 Dust protection cap material
 Bending protection sleeve material
 Cable pull-out force, min.
 Housing main material
 Housing material, insert
 Humidity
 Sheath diameter, min. / max.
 Approvals

IP 20
 1000
 -20 °C...80 °C
 IEC 61754-24
 0.6 mm...1.4 mm
 Copper, nickel-plated
 Rustless steel
 Zirconia, Hole 125.5 µm
 TPE
 TPE
 100 N
 PC UL 94 V0
 Zinc diecast
 0...93 % rel. humidity
 2.8 mm / 3 mm
 EAC; UL

IP 20
 1000
 -20 °C...80 °C
 IEC 61754-2
 Copper, nickel-plated
 TPE
 TPE
 100 N
 Zinc diecast
 2.8 mm / 3 mm
 EAC

Note

Ordering data

Singlemode
 Multimode
 POF

Type	Qty.	Order No.
IE-PS-SCRJ1-SM	10	1206740000
IE-PS-SCRJ1-MM	10	1206730000
IE-PS-SCRJ1-POF	10	1206720000

Note

Type	Qty.	Order No.
IE-PS-ST-MM	1	1968150000

Accessories

Tools

Crimping tool POF
 Replacement ferrule
 Contact Removal Tool
 Fibre-optic tool case

Type	Qty.	Order No.
HTX-IE-POF	1	1208870000
IE-SCRJ1-IP20-POF-100	100	1278420000
REMOVAL TOOL HD	1	1866730000

Type	Qty.	Order No.
IE-CTC-SCST-GOF	1	1032030000

Note

FO connector

- IP 20

SC Duplex

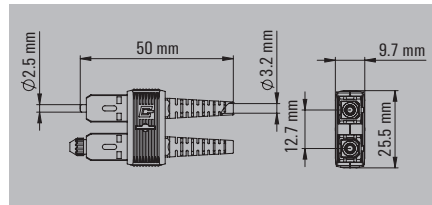

LC duplex

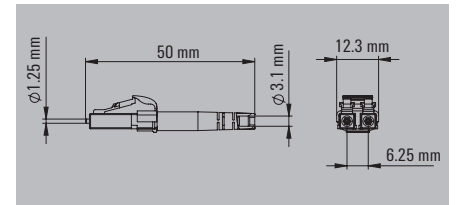
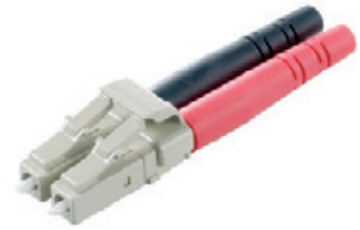

Technical data

Protection degree
Plugging cycles
Ambient temperature (operational)
Connector standard
Individual wire diameter, min. / max.
Crimp barrel material
Pressure spring material
Ferrule material
Dust protection cap material
Bending protection sleeve material
Cable pull-out force, min.
Housing main material
Housing material, insert
Humidity
Sheath diameter, min. / max.
Approvals

IP 20
1000
-40 °C...70 °C
IEC 61754-4
0.6 mm...1.4 mm
Copper, nickel-plated
Rustless steel
Zirconia, Hole 127 μm
TPE
TPE
100 N
PC UL 94 V0
Zinc diecast
0...93 % rel. humidity
2.8 mm / 3 mm
EAC; UL

IP 20
1000
-40 °C...70 °C
IEC 61754-20
0.6 mm...1.4 mm
Copper, nickel-plated
Rustless steel
Zirconia, Hole 127 μm
TPE
TPE
100 N
PC UL 94 V0
Zinc diecast
0...93 % rel. humidity
2.8 mm / 3 mm
EAC

Note

Ordering data

Singlemode
Multimode

Note

Type	Qty.	Order No.
IE-PS-SCD-SM	10	1964410000
IE-PS-SCD-MM	10	1964480000

Type	Qty.	Order No.
IE-PS-LCD-SM	10	1962980000
IE-PS-LCD-MM	10	1962970000

Accessories

Tools



Fibre-optic tool case
Accessory set for LC plugs

Type	Qty.	Order No.
IE-CTC-SCST-GOF	1	1032030000

Type	Qty.	Order No.
IE-CTC-SCST-GOF	1	1032030000
IE-CTC-AS-LC-GOF	1	1033350000

Note

Coupling BNC

BNC

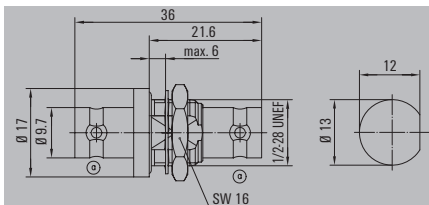

Technical data

Housing main material
Insulation
Return loss (attenuation)
Characteristic impedance
O-Ring
Connector standard
Approvals
Note

Brass, nickel-plated
PTFE
23 dB at 4 GHz, 27 dB at 1 GHz
50 Ω
NBR
IEC 61169-8
Note

Ordering data

Note

Type	Qty.	Order No.
IE-BI-BNC-C	1	1345020000
Note		

Accessories

Note

Type	Qty.	Order No.
Note		

Note

Note

RJ45 PCB socket

RJ45 PCB socket

- Cat. 5
- IP 20
- THR

Lower locking lever

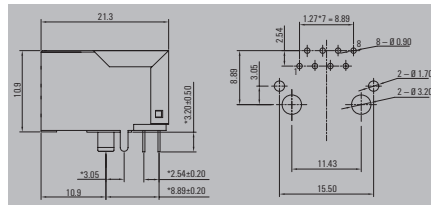

Upper locking lever

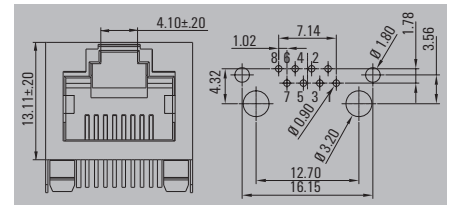

Technical data

Category
Protection degree
Housing main material
Contact material
Contact surface
Shielding
Shielding material
Plugging cycles
Ambient temperature (operational)
Contact resistance
Insulation resistance
Connector standard
Rated current
Rated voltage
Approvals

Cat.5 (ISO/IEC 11801)
IP 20
FR52 UL94V-0
Phosphorus bronze
Selective gold 30µm
Yes
Copper alloy
750
-40 °C...85 °C
≤ 20 mΩ
> 500 MΩ
IEC 60603-7-51
1.5 A
125 V AC
EAC; UL

Cat.5 (ISO/IEC 11801)
IP 20
FR52 UL94V-0
Phosphorus bronze
Selective gold 30µm
Yes
Copper alloy
750
-40 °C...85 °C
≤ 20 mΩ
> 500 MΩ
IEC 60603-7-51
1.5 A
125 V AC
EAC; UL

Note

Ordering data

Female

Type	Qty.	Order No.
IE-PCB-RJ45-THR-C5-A	90	1433800000
Other versions on request		

Type	Qty.	Order No.
IE-PCB-RJ45-THR-C5-AI	70	1455240000
Other versions on request		

Note

Accessories

Type	Qty.	Order No.

Type	Qty.	Order No.

Note

RJ45 PCB socket

- Cat. 5
- IP 20
- THR

180°

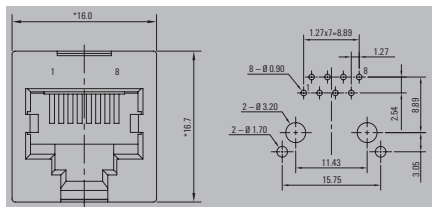

Technical data

Category	Cat.5 (ISO/IEC 11801)
Protection degree	IP 20
Housing main material	FR52 UL94V-0
Contact material	Phosphorus bronze
Contact surface	Selective gold 30µm
Shielding	Yes
Shielding material	Copper alloy
Plugging cycles	750
Ambient temperature (operational)	-40 °C...85 °C
Contact resistance	≤ 20 mΩ
Insulation resistance	> 500 MΩ
Connector standard	IEC 60603-7-51
Rated current	1.5 A
Rated voltage	125 V AC
Approvals	EAC; UL
Note	

Category	Cat.5 (ISO/IEC 11801)
Protection degree	IP 20
Housing main material	FR52 UL94V-0
Contact material	Phosphorus bronze
Contact surface	Selective gold 30µm
Shielding	Yes
Shielding material	Copper alloy
Plugging cycles	750
Ambient temperature (operational)	-40 °C...85 °C
Contact resistance	≤ 20 mΩ
Insulation resistance	> 500 MΩ
Connector standard	IEC 60603-7-51
Rated current	1.5 A
Rated voltage	125 V AC
Approvals	EAC; UL
Note	

Ordering data

Female
Note

Type	Qty.	Order No.
IE-PCB-RJ45-THR-C5-S	60	1433810000
Other versions on request		

Accessories

Type	Qty.	Order No.

Note

--

RJ45 PCB socket

RJ45 PCB socket

- Cat. 5
- IP 20
- SMD

Lower locking lever

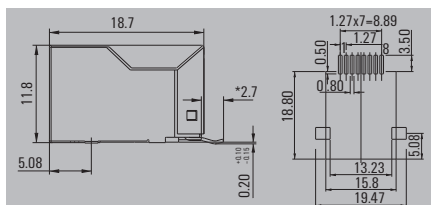

Upper locking lever

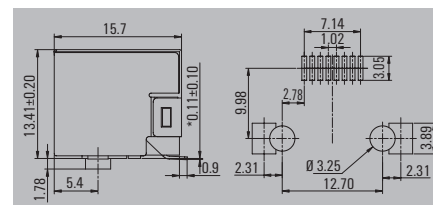

Technical data

Category
Protection degree
Housing main material
Contact material
Contact surface
Shielding
Shielding material
Plugging cycles
Ambient temperature (operational)
Contact resistance
Insulation resistance
Connector standard
Rated current
Rated voltage
Approvals

Cat.5 (ISO/IEC 11801)
IP 20
FR52 UL94V-0
Phosphorus bronze
Selective gold 30µm
Yes
Copper alloy
750
-40 °C...85 °C
≤ 20 mΩ
> 500 MΩ
IEC 60603-7-51
1.5 A
125 V AC
EAC; UL

Cat.5 (ISO/IEC 11801)
IP 20
FR52 UL94V-0
Phosphorus bronze
Selective gold 30µm
Yes
Copper alloy
750
-40 °C...85 °C
≤ 20 mΩ
> 500 MΩ
IEC 60603-7-51
1.5 A
125 V AC
EAC; UL

Note

Ordering data

Note

Type	Qty.	Order No.
IE-PCB-RJ45-SMD-C5-A	150	1433890000
Other versions on request		

Type	Qty.	Order No.
IE-PCB-RJ45-SMD-C5-AI	100	1455220000
Other versions on request		

Accessories

Type	Qty.	Order No.

Type	Qty.	Order No.

Note

RJ45 PCB socket

- Cat. 5
- IP 20
- SMD

180°

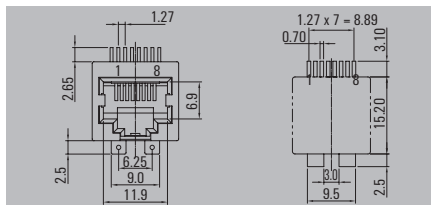

Technical data

Category	Cat.5 (ISO/IEC 11801)
Protection degree	IP 20
Housing main material	FR52 UL94V-0
Contact material	Phosphorus bronze
Contact surface	Selective gold 30µm
Shielding	Yes
Shielding material	Copper alloy
Plugging cycles	750
Ambient temperature (operational)	-40 °C...85 °C
Contact resistance	≤ 20 mΩ
Insulation resistance	> 500 MΩ
Connector standard	IEC 60603-7-51
Rated current	1.5 A
Rated voltage	125 V AC
Approvals	EAC, UL
Note	

Category	Cat.5 (ISO/IEC 11801)
Protection degree	IP 20
Housing main material	FR52 UL94V-0
Contact material	Phosphorus bronze
Contact surface	Selective gold 30µm
Shielding	Yes
Shielding material	Copper alloy
Plugging cycles	750
Ambient temperature (operational)	-40 °C...85 °C
Contact resistance	≤ 20 mΩ
Insulation resistance	> 500 MΩ
Connector standard	IEC 60603-7-51
Rated current	1.5 A
Rated voltage	125 V AC
Approvals	EAC, UL
Note	

Ordering data

Note

Type	Qty.	Order No.
IE-PCB-RJ45-SMD-C5-S	150	1433900000
Other versions on request		

Accessories

Type	Qty.	Order No.

Note

Note

RJ45 PCB socket

RJ45 PCB socket

- Cat. 6
- IP 20
- THR

Upper locking lever

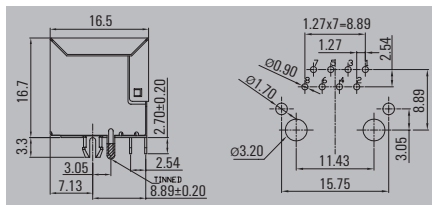

180°

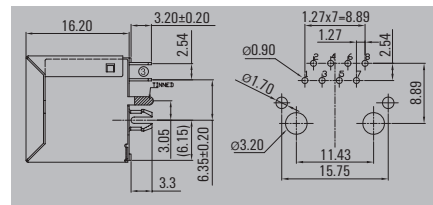

Technical data

Category
Protection degree
Housing main material
Contact material
Contact surface
Shielding
Shielding material
Plugging cycles
Ambient temperature (operational)
Contact resistance
Insulation resistance
Connector standard
Rated current
Rated voltage
Approvals

Cat.6 (ISO/IEC 11801)
IP 20
FR52 UL94V-0
Phosphorus bronze
Selective gold 30µm
Yes
Copper alloy
750
-40 °C...85 °C
≤ 20 mΩ
> 500 MΩ
IEC 60603-7-51
1.5 A
125 V AC
EAC; UL

Cat.6 (ISO/IEC 11801)
IP 20
FR52 UL94V-0
Phosphorus bronze
Selective gold 30µm
Yes
Copper alloy
750
-40 °C...85 °C
≤ 20 mΩ
> 500 MΩ
IEC 60603-7-51
1.5 A
125 V AC
EAC; UL

Note

Ordering data

Note

Accessories

Type	Qty.	Order No.
IE-PCB-RJ45-THR-C6-AI	80	1433910000
Other versions on request		

Type	Qty.	Order No.
IE-PCB-RJ45-THR-C6-S	80	1433920000
Other versions on request		

Type	Qty.	Order No.

Type	Qty.	Order No.

Note

Module RJ45

Outlet direction straight

- Cat. 6A
- IP 20
- TS 35

8-wire

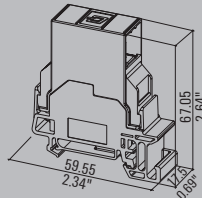

4-wire

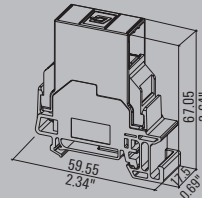

Technical data

Category
Protection degree
Housing main material
Contact surface
Colour
Type of mounting
Plugging cycles
Configuration
Ambient temperature (operational)
Temperature range, installation, min. / max.
Connector standard
Connection diameter, flexible, min. / max.
Connection cross-section, flexible, min. / max.
Connection diameter, solid, min. / max.
Connection cross-section, solid, min. / max.
Electrical properties*
PoE / PoE+
Contact resistance
Current-carrying capacity at 50 °C
Dielectric strength, contact / contact
Dielectric strength, contact / shield
Insulation resistance
Approvals
Note

Cat.6 _n / Class E _n (ISO/IEC 11801 2010)
IP 20
PA UL 94 V0
Au ≥ 0.8 µm
Light Grey
TS 35
750
Switchable volt. connection from module/coupling to mounting rail
-40 °C...70 °C
-25 °C...70 °C
IEC 60603-7-51
0.48 mm / 0.76 mm
AWG 26 / AWG 22
0.4 mm / 0.64 mm
AWG 24 / AWG 22
conforming to IEEE 802.3af
≤ 20 mΩ
1 A
≥ 1000 V DC
≥ 1500 V DC
500 MΩ
EAC
Weidmüller connection cat. 7 AWG 27/7 LSZH cable possible

Cat.5 (ISO/IEC 11801)
IP 20
PA UL 94 V0
Au ≥ 0.8 µm
Light Grey
TS 35
750
Switchable volt. connection from module/coupling to mounting rail
-40 °C...70 °C
-25 °C...70 °C
IEC 60603-7-51
0.48 mm / 0.76 mm
AWG 26 / AWG 22
0.4 mm / 0.64 mm
AWG 24 / AWG 22
conforming to IEEE 802.3af
≤ 20 mΩ
1 A
≥ 1000 V DC
≥ 1500 V DC
500 MΩ
EAC

Ordering data

A-coded
B-coded
Outlet RJ45 PROFINET-coded
Note

Type	Qty.	Order No.
IE-TO-RJ45-FJ-A	10	8946930000
IE-TO-RJ45-FJ-B	10	8946940000

Type	Qty.	Order No.
IE-TO-RJ45-FJ-P	10	8946950000

Accessories

Markers
9*11 mm, white

Type	Qty.	Order No.
ESG 9/11 K MC NE WS		1857440000

Type	Qty.	Order No.
ESG 9/11 K MC NE WS		1857440000

Note

Note

Note

Module RJ45

Outlet direction diagonal

- Cat. 6
- IP 20
- TS 35

8-wire

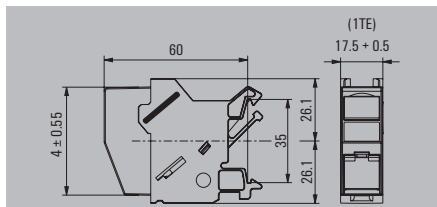

Technical data

Category	
Protection degree	
Housing main material	
Contact surface	
Colour	
Type of mounting	
Plugging cycles	
Configuration	
Ambient temperature (operational)	
Temperature range, installation, min. / max.	
Connector standard	
Connection diameter, flexible, min. / max.	
Connection cross-section, flexible, min. / max.	
Connection diameter, solid, min. / max.	
Connection cross-section, solid, min. / max.	
Electrical properties*	
PoE / PoE+	
Contact resistance	
Current-carrying capacity at 50 °C	
Dielectric strength, contact / contact	
Dielectric strength, contact / shield	
Insulation resistance	
Approvals	
Note	

Cat.6 (ISO/IEC 11801)
IP 20
PA 66, UL 94: V-0
Light Grey
TS 35
750
Inspection window for labelling
1 TE pitch dimension acc. to DIN 43880. insta-compatible
-25 °C...70 °C
IEC 60603-7-5
0.4 mm / 0.64 mm
AWG 26 / AWG 22
0.4 mm / 0.64 mm
AWG 26 / AWG 22
conforming to IEEE 802.3at
≤ 20 mΩ
1 A
≥ 1000 V DC
≥ 1500 V DC
500 MΩ
CULUS; EAC; GERMLLOYD

Ordering data

	A/B-coded
Note	

Type	Qty.	Order No.
IE-XM-RJ45/IDC	1	8808360000

Accessories

Markers	
	Marking tag

Type	Qty.	Order No.
IE-DM	50	8813500000

Note

--

Coupling RJ45, 8-wire

- Cat. 6_A
- IP 20
- TS 35

Outlet direction straight



Outlet direction diagonal

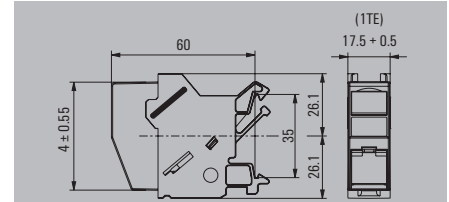
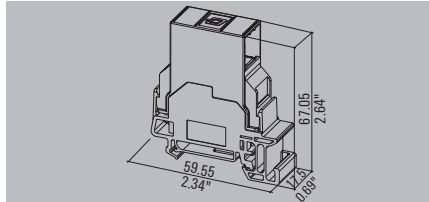

Technical data

Category
Protection degree
Housing main material
Contact material / Contact surface
Colour
Type of mounting
Plugging cycles
Configuration
Ambient temperature (operational)
Temperature range, installation, min. / / max.
Humidity
Shock resistance acc. to IEC 60512-4
Vibration resistance acc. to IEC 60512-4
Housing material, insert
Connector standard
Electrical properties*
PoE / PoE+
Contact resistance
Current-carrying capacity at 50 °C
Dielectric strength, contact / contact
Dielectric strength, contact / shield
Insulation resistance
Approvals
Note

Cat.6 _A / Class E _A (ISO/IEC 11801 2010)
IP 20
PA UL 94 V0
Spring steel, Ni 1.2 µm / Au ≥ 0.8 µm
Light Grey
TS 35
750
Switchable volt. connection from module/coupling to mounting rail
-40 °C...70 °C
-25 °C...70 °C
0...93 % rel. humidity
250 ms ²
50 ms ² sinusoidal (9 - 500 Hz)
Zinc diecast
IEC 60603-7-51
conforming to IEEE 802.3af
≤ 20 mΩ
1 A
≥ 1000 V DC
≥ 1500 V DC
500 MΩ
EAC

Cat.6 (ISO/IEC 11801)
IP 20
PA 66, UL 94: V-0
Light Grey
TS 35
750
Inspection window for labelling
1 TE pitch dimension acc. to DIN 43880. insta-compatible
-25 °C...70 °C
IEC 60603-7-5
conforming to IEEE 802.3at
≤ 20 mΩ
1 A
≥ 1000 V DC
≥ 1500 V DC
500 MΩ
CULUS; EAC; GERMLLOYD

Ordering data

Note

Type	Qty.	Order No.
IE-TO-RJ45-C	10	8946920000

Type	Qty.	Order No.
IE-XM-RJ45/RJ45	1	8879050000

Accessories

Markers	9*11 mm, white Marking tag
----------------	-------------------------------

Type	Qty.	Order No.
ESG 9/11 K MC NE WS		1857440000

Type	Qty.	Order No.
IE-DM	50	8813500000

Note

--

--

IP 20 mounting rail outlets

USB connection

- IP 20
- TS 35

USB A

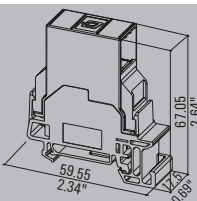

USB AB

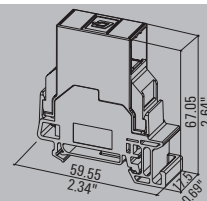

Technical data

Protection degree
Housing main material
Colour
Type of mounting
Ambient temperature (operational)
Temperature range, installation, min. / max.
Connector standard
Connection 1 / 2
Approvals

IP 20
PA UL 94 V0
Light Grey
TS 35
-40 °C...70 °C
-25 °C...70 °C
IEC 61076-3-107
USB A / USB A
EAC

IP 20
PA UL 94 V0
Light Grey
TS 35
-40 °C...70 °C
-25 °C...70 °C
IEC 61076-3-107
USB A / USB B
EAC

Note

Ordering data

USB
Note

Type	Qty.	Order No.
IE-T0-USB	10	8946960000

Type	Qty.	Order No.
IE-T0-USB-AB	1	1438180000

Accessories

Markers
9*11 mm. white

Type	Qty.	Order No.
ESG 9/11 K MC NE WS		1857440000

Type	Qty.	Order No.
ESG 9/11 K MC NE WS		1857440000

Note

Coupling fibre-optic

- IP 20
- TS 35

SC duplex



SC-RJ

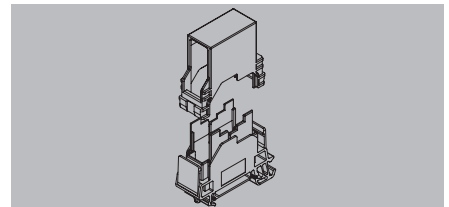
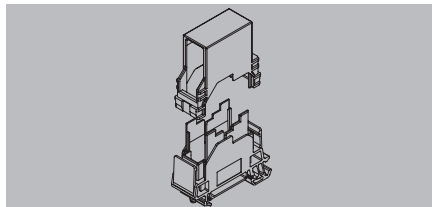

Technical data

Protection degree
 Housing main material
 Colour
 Type of mounting
 Plugging cycles
 Ambient temperature (operational)
 Temperature range, installation, min. / / max.
 Connector standard
 Approvals

IP 20
 PA UL 94 V0
 Light Grey
 TS 35
 1000
 -40 °C...70 °C
 -25 °C...70 °C
 IEC 61754-4
 EAC; UL

IP 20
 PA UL 94 V0
 Light Grey
 TS 35
 1000
 -40 °C...70 °C
 -25 °C...70 °C
 IEC 61754-24
 EAC; UL

Note

Ordering data

Fibre-optic	
	Singlemode
	Multimode/POF

Note

Type	Qty.	Order No.
IE-TO-SCD-SM	10	8946980000
IE-TO-SCD-MM	10	8946970000

Type	Qty.	Order No.
IE-TO-SCRJ-SM	10	8947000000
IE-TO-SCRJ-MM	10	8946990000

Accessories

Markers	
	9*11 mm. white

Type	Qty.	Order No.
ESG 9/11 K MC NE WS		1857440000

Type	Qty.	Order No.
ESG 9/11 K MC NE WS		1857440000

Note

Coupling fibre-optic

- IP 20
- TS 35

LC Duplex



ST

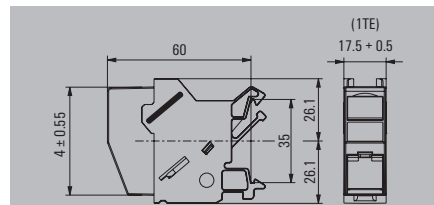
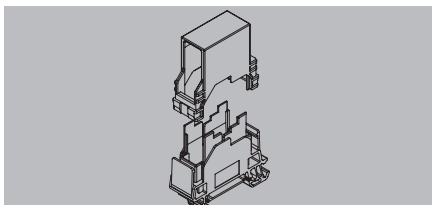

Technical data

Protection degree
 Housing main material
 Colour
 Type of mounting
 Plugging cycles
 Ambient temperature (operational)
 Temperature range, installation, min. / / max.
 Connector standard
 Approvals

IP 20
 PA UL 94 V0
 Light Grey
 TS 35
 1000
 -40 °C...70 °C
 -25 °C...70 °C
 IEC 61754-20
 EAC

IP 20
 PA 66, UL 94: V-0
 Light Grey
 TS 35
 750
 -25 °C...70 °C
 IEC 61754-2
 EAC

Note

Ordering data

	Singlemode
	Multimode
Note	

Type	Qty.	Order No.
IE-TO-LCD-SM	10	8947020000
IE-TO-LCD-MM	10	8947010000

Type	Qty.	Order No.
IE-XM-ST/ST	1	8808340000

Accessories

Markers	
	9*11 mm, white
	Marking tag

Type	Qty.	Order No.
ESG 9/11 K MC NE WS		1857440000

Type	Qty.	Order No.
IE-DM	50	8813500000

Note

IP 65 service interface FrontCom®

Overview

IP 65 service interface FrontCom®	IP 65 service interface FrontCom® Vario	1.2
	IP 65 service interface FrontCom® Micro	
	RJ45	1.24
	USB	1.26

IP 65 service interface FrontCom® Vario

FrontCom® Vario

Frame

- IP 65

Metal cover

Plastic cover

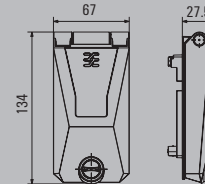
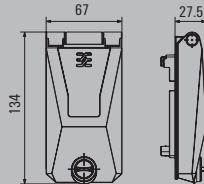

Technical data

Protection degree
Material cover
Material frame
Ambient temperature (operational)
Approvals
Note

IP 65 in enclosed state
Zinc diecast, powder-coated
Zinc diecast
-40 °C...70 °C
CURUS; GERMLLOYD
Note

IP 65 in enclosed state
Polycarbonate PC
Zinc diecast
-40 °C...70 °C
GERMLLOYD
Note

Ordering data

Button operation
Lockable with key
Note

Type	Qty.	Order No.
IE-FC-SFM-KNOB	1	1450530000
IE-FC-SFM-KEY	1	1450540000
Note		

Type	Qty.	Order No.
IE-FC-SFP-KNOB	1	1450510000
IE-FC-SFP-KEY	1	1450520000
Note		

Accessories

Spare key
Markers
silver
light grey
white
for touch-safe protection and insert plates
Touch-safe protection
Touch-safe protection
Note

Type	Qty.	Order No.
IE-FC-KEY	1	1465930000
SM 27/18 K MC NE SI	80	1713760000
SM 27/18 K MC NE GR	80	1073340000
SM 27/18 K MC NE WS	80	1707270000
ESG 7/20 SIRIUS MC NE WS	200	1736181044
IE-FC-PWPC	1	1450820000
Note		

Type	Qty.	Order No.
IE-FC-KEY	1	1465930000
SM 27/18 K MC NE SI	80	1713760000
SM 27/18 K MC NE GR	80	1073340000
SM 27/18 K MC NE WS	80	1707270000
ESG 7/20 SIRIUS MC NE WS	200	1736181044
IE-FC-PWPC	1	1450820000
Note		

FrontCom® Vario

Insert plates

- IP 20

1x Power, 2x Data

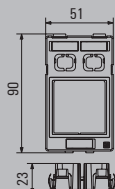

1x Power, 2x Data, 1x Signal

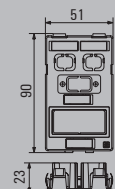

Technical data

Material
Insert, data
Signal insert D-Sub 9-pole / VGA / HDMI
Insert, signal, D-Sub, 25-pole
Insert Power large
Insert Power small
Insert Power US
Ambient temperature (operational)
Approvals
Note

Polycarbonate PC
2
1
1
-40 °C...70 °C
GERMLLOYD

Polycarbonate PC
2
1
1
-40 °C...70 °C
GERMLLOYD

Ordering data

shielded
unshielded
Note

Type	Qty.	Order No.
IE-FC-SP-PWB/2ST	1	1450550000
IE-FC-IP-PWB/2ST	1	1450630000

Type	Qty.	Order No.
IE-FC-SP-PWS/2ST/1D9	1	1450600000
IE-FC-IP-PWS/2ST/1D9	1	1450690000

Accessories

Inserts, Power	
Socket AU 15 A	
Socket AU 10 A	
Socket CH	
Socket CN	
Socket GB	
Socket DE	
Socket DE orange	
Socket FR	
Socket FR orange	
Socket EU	
Socket IT	
Socket multi-contact	
RCBO	
Inserts, Data	
RJ45 coupling	
RJ45 module EIA/TIA T568 B	
RJ45 module PROFINET	
RJ45 module EIA/TIA T568 A	
USB 2.0 A / A	
USB 3.0 A / A	
USB 2.0 A / B	
Markers	
for touch-safe protection and insert plates	
Touch-safe protection	
Touch-safe protection	
Inserts, Signal	
D-Sub, 9-pole, female/female	
D-Sub, 9-pole, female / male	
D-Sub, 9-pole, female / solder connection	
Note	

Type	Qty.	Order No.
IE-FCI-PWB-AU	1	1450830000
IE-FCI-PWB-AU-10A	10	1546590000
IE-FCI-PWB-CH	1	1450780000
IE-FCI-PWB-CN	1	1450790000
IE-FCI-PWB-GB	1	1450770000
IE-FCI-PWB-DE	1	1450730000
IE-FCI-PWB-DE-OR	1	1554000000
IE-FCI-PWB-FR	1	1450750000
IE-FCI-PWB-FR-OR	1	2007230000
IE-FCI-PWS-EU	1	1450740000
IE-FCI-PWS-IT	1	1450810000
IE-FCI-PWB-MC	1	1529570000
IE-FCI-PWB-RCBO	1	1534250000
IE-BI-RJ45-C	10	1962840000
IE-BI-RJ45-FJ-B	10	1963840000
IE-BI-RJ45-FJ-P	10	1963830000
IE-BI-RJ45-FJ-A	10	1962850000
IE-BI-USB-A	10	1019570000
IE-BI-USB-3.0-A	1	1487920000
IE-BI-USB-AB	10	1131380000
ESG 7/20 SIRIUS MC NE WS	200	1736181044
IE-FC-PWPC	1	1450820000
IE-FCI-D9-FF	1	1450840000
IE-FCI-D9-FM	1	1450850000
IE-FCI-D9-FS	1	1450870000

Type	Qty.	Order No.
IE-FCI-PWS-EU	1	1450740000
IE-FCI-PWS-IT	1	1450810000
IE-BI-RJ45-C	10	1962840000
IE-BI-RJ45-FJ-B	10	1963840000
IE-BI-RJ45-FJ-P	10	1963830000
IE-BI-RJ45-FJ-A	10	1962850000
IE-BI-USB-A	10	1019570000
IE-BI-USB-3.0-A	1	1487920000
IE-BI-USB-AB	10	1131380000
ESG 7/20 SIRIUS MC NE WS	200	1736181044
IE-FC-PWPC	1	1450820000
IE-FCI-D9-FF	1	1450840000
IE-FCI-D9-FM	1	1450850000
IE-FCI-D9-FS	1	1450870000

FrontCom® Vario

Insert plates

- IP 20

1x Power, 2x Data

1x power, 1x 3A fuse, 1x data

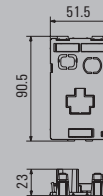
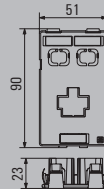

Technical data

Material
 Insert, data
 Signal insert D-Sub 9-pole / VGA / HDMI
 Insert, signal, D-Sub, 25-pole
 Insert Power large
 Insert Power small
 Insert Power US
 Ambient temperature (operational)
 Approvals

Polycarbonate PC
 2
 1
 -40 °C...70 °C
 GERMLLOYD

Polycarbonate PC
 1
 1
 -40 °C...70 °C

Note

Ordering data

shielded
 unshielded

Note

Type	Qty.	Order No.
IE-FC-SP-PWU/2ST	1	1450620000
IE-FC-IP-PWU/2ST	1	1450700000

For US socket the touch-safe protection is mandatory

Type	Qty.	Order No.
IE-FC-IP-PWU/1ST/CB	1	1543710000

Touch-safe protection is obligatory when using the US socket

Accessories

Inserts, Data	
RJ45 coupling	RJ45 module EIA/TIA T568 A
RJ45 module EIA/TIA T568 B	RJ45 module PROFINET
USB 2.0 A / A	USB 2.0 A / B
USB 3.0 A / A	
Inserts, Signal	
D-Sub, 9-pole, female / male	D-Sub, 9-pole, female / solder connection
D-Sub, 9-pole, female/female	
Markers	
for touch-safe protection and insert plates	
Touch-safe protection	
Touch-safe protection	
Inserts, Power	
Fuse inserts	
	3 A

Type	Qty.	Order No.
IE-BI-RJ45-C	10	1962840000
IE-BI-RJ45-FJ-A	10	1962850000
IE-BI-RJ45-FJ-B	10	1963840000
IE-BI-RJ45-FJ-P	10	1963830000
IE-BI-USB-A	10	1019570000
IE-BI-USB-AB	10	1131380000
IE-BI-USB-3.0-A	1	1487920000
ESG 7/20 SIRIUS MC NE WS	200	1736181044
IE-FC-PWPC	1	1450820000
IE-FCI-PWS-US	1	1450800000

Type	Qty.	Order No.
IE-BI-RJ45-C	10	1962840000
IE-BI-RJ45-FJ-A	10	1962850000
IE-BI-RJ45-FJ-B	10	1963840000
IE-BI-RJ45-FJ-P	10	1963830000
IE-BI-USB-A	10	1019570000
IE-BI-USB-AB	10	1131380000
IE-BI-USB-3.0-A	1	1487920000
ESG 7/20 SIRIUS MC NE WS	200	1736181044
IE-FC-PWPC	1	1450820000
IE-FCI-PWS-US	1	1450800000
IE-FCI-PWCB-3A	1	1543690000

Note

FrontCom® Vario

Insert plates

- IP 20

1x Power, 4x Data

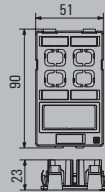

1x Power, 2x Signal

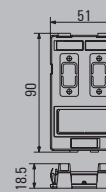

Technical data

Material
Insert, data
Signal insert D-Sub 9-pole / VGA / HDMI
Insert, signal, D-Sub, 25-pole
Insert Power large
Insert Power small
Insert Power US
Ambient temperature (operational)
Approvals
Note

Polycarbonate PC
4
2
1
-40 °C...70 °C
GERMLLOYD

Polycarbonate PC
2
1
-40 °C...70 °C
GERMLLOYD

Ordering data

shielded
unshielded
Note

Type	Qty.	Order No.
IE-FC-SP-PWS/4ST	1	1450570000
IE-FC-IP-PWS/4ST	1	1450640000

Type	Qty.	Order No.
IE-FC-SP-PWS/2D9	1	1450610000
IE-FC-IP-PWS/2D9	1	1450680000

Accessories

Inserts, Power	
Socket EU	
Socket IT	
Inserts, Data	
RJ45 coupling	
RJ45 module EIA/TIA T568 A	
RJ45 module EIA/TIA T568 B	
RJ45 module PROFINET	
USB 2.0 A / A	
USB 3.0 A / A	
USB 2.0 A / B	
Markers	
for touch-safe protection and insert plates	
Touch-safe protection	
Touch-safe protection	
Inserts, Signal	
D-Sub, 9-pole, female/female	
D-Sub, 9-pole, female / male	
D-Sub, 9-pole, female / solder connection	
Note	

Type	Qty.	Order No.
IE-FCI-PWS-EU	1	1450740000
IE-FCI-PWS-IT	1	1450810000
IE-BI-RJ45-C	10	1962840000
IE-BI-RJ45-FJ-A	10	1962850000
IE-BI-RJ45-FJ-B	10	1963840000
IE-BI-RJ45-FJ-P	10	1963830000
IE-BI-USB-A	10	1019570000
IE-BI-USB-3.0-A	1	1487920000
IE-BI-USB-AB	10	1131380000
ESG 7/20 SIRIUS MC NE WS	200	1736181044
IE-FC-PWPC	1	1450820000

Type	Qty.	Order No.
IE-FCI-PWS-EU	1	1450740000
IE-FCI-PWS-IT	1	1450810000
IE-FCI-D9-FF	1	1450840000
IE-FCI-D9-FM	1	1450850000
IE-FCI-D9-FS	1	1450870000
ESG 7/20 SIRIUS MC NE WS	200	1736181044
IE-FC-PWPC	1	1450820000

Data inserts
USB

- Cat. 6_A
- IP 20
- For housing variants 1, 4, 5, 14 and for FrontCom®

Coupling USB A/A



Coupling USB A/B

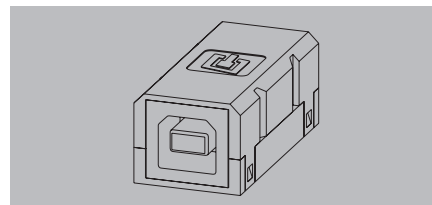
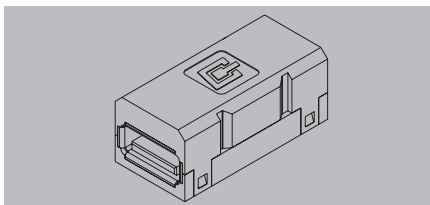

Technical data

Protection degree
Shielding
Ambient temperature (operational)
Connection 1 / 2
Connector standard
Approvals

IP 67 with housing
360° all-round enclosure
-40 °C...70 °C
USB A / USB A
IEC 61076-3-107
GERMLLOYD

IP 67 with housing
360° all-round enclosure
-40 °C...70 °C
USB A / USB B
IEC 61076-3-107
GERMLLOYD

Note

Ordering data

Type	Qty.	Order No.
IE-BI-USB-A	10	1019570000
IE-BI-USB-3.0-A	1	1487920000

Note

Type	Qty.	Order No.
IE-BI-USB-AB	10	1131380000

Accessories

Type	Qty.	Order No.

Type	Qty.	Order No.

Type	Qty.	Order No.

Note

IP 65 service interface FrontCom® Vario

Signal inserts

D-Sub

- IP 20

9-pole

25-pole

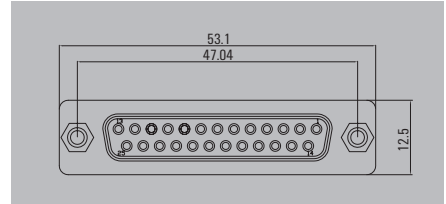
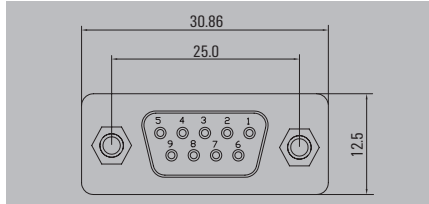
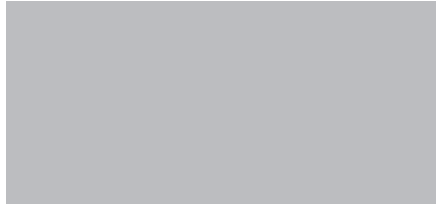

Technical data

Protection degree	IP 20
Housing main material	SPCC
No. of poles	9
Housing surface	tin-plated
Material insulator	PBT glass-fibre reinforced UL 94 V-0
Contact surface	Gold-plated
Contact resistance	≤ 20 mΩ
Insulation resistance	1000 MΩ at 500 V DC
Dielectric strength, contact / contact	1 kV _{eff} / 1 min.
Ambient temperature (operational)	-55 °C...105 °C
Approvals	GERMLLOYD
Note	

Protection degree	IP 20
Housing main material	SPCC
No. of poles	25
Housing surface	tin-plated
Material insulator	PBT glass-fibre reinforced UL 94 V-0
Contact surface	Gold-plated
Contact resistance	≤ 20 mΩ
Insulation resistance	1000 MΩ at 500 V DC
Dielectric strength, contact / contact	1 kV _{eff} / 1 min.
Ambient temperature (operational)	-55 °C...105 °C
Approvals	GERMLLOYD
Note	

Protection degree	IP 20
Housing main material	SPCC
No. of poles	25
Housing surface	tin-plated
Material insulator	PBT glass-fibre reinforced UL 94 V-0
Contact surface	Gold-plated
Contact resistance	≤ 20 mΩ
Insulation resistance	1000 MΩ at 500 V DC
Dielectric strength, contact / contact	1 kV _{eff} / 1 min.
Ambient temperature (operational)	-55 °C...105 °C
Approvals	GERMLLOYD
Note	

Ordering data

	Female / Female
	Female / Male
	Female / Solder connection
Note	

Type	Qty.	Order No.
IE-FCI-D9-FF	1	1450840000
IE-FCI-D9-FM	1	1450850000
IE-FCI-D9-FS	1	1450870000

Type	Qty.	Order No.
IE-FCI-D25-FF	1	1450880000
IE-FCI-D25-FM	1	1450890000
IE-FCI-D25-FS	1	1450900000

Accessories

	Cable-lug sleeve
--	------------------

Type	Qty.	Order No.

Type	Qty.	Order No.

Note

--

--

Signal inserts

- IP 20

HDMI



HD15 / VGA

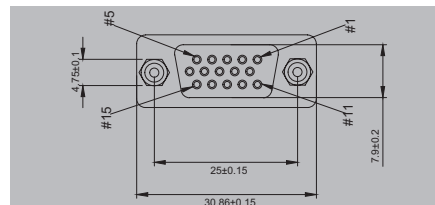

Technical data

Protection degree
 Housing main material
 No. of poles
 Housing surface
 Contact surface
 Contact resistance
 Insulation resistance
 Dielectric strength, contact / contact
 Ambient temperature (operational)
 Approvals

IP 20
 PVC casting
 9
 Gold-plated
 -15 °C...50 °C

IP 20
 25
 Gold over nickel
 1000 MΩ at 500 V DC
 1000 V_{eff} / 1 min
 -55 °C...105 °C
 GERMLLOYD

Note

Ordering data

Note

Accessories

Note

Type	Qty.	Order No.
IE-FCHDMI-FF	1	2003390000

Type	Qty.	Order No.

Type	Qty.	Order No.
IE-FCHD15-FF	1	1556290000

Type	Qty.	Order No.

IP 65 service interface FrontCom® Vario

Power inserts

Sockets

- IP 20

Germany, white

Germany, orange

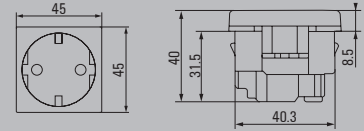
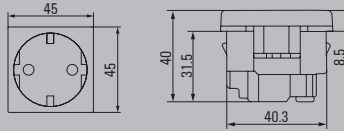

Technical data

Protection degree
 Housing main material
 Type of connection
 Line connection cross-section
 finely stranded with wire-end ferrule
 finely stranded without wire-end ferrule
 finely stranded with wire-end ferrule
 finely stranded without wire-end ferrule
 Conductor connection cross-section, rigid
 Stripping length
 Rated voltage (AC)
 Rated current
 Ambient temperature (operational)
 Approvals

IP 20
 Polycarbonate PC
 PUSH IN
 1.5 ... 1.5 mm²
 1.5 ... 2.5 mm²
 1.5 ... 1.5 mm²
 1.5 ... 2.5 mm²
 1.5 ... 2.5 mm²
 10 mm
 250 V
 16 A
 -5 °C...50 °C
 GERMLLOYD

IP 20
 Polycarbonate PC
 PUSH IN
 1.5 ... 1.5 mm²
 1.5 ... 2.5 mm²
 1.5 ... 1.5 mm²
 1.5 ... 2.5 mm²
 1.5 ... 2.5 mm²
 1.5 ... 2.5 mm²
 10 mm
 250 V
 16 A
 -5 °C...50 °C
 GERMLLOYD

Note

Ordering data

Type	Qty.	Order No.
IE-FCI-PWB-DE	1	1450730000

Type	Qty.	Order No.
IE-FCI-PWB-DE-OR	1	1554000000

Note

Accessories

Type	Qty.	Order No.
------	------	-----------

Type	Qty.	Order No.
------	------	-----------

Note

Switzerland

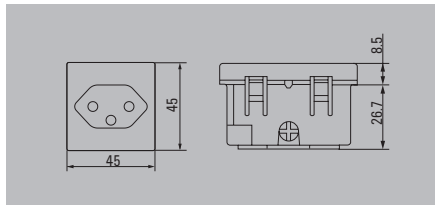

IP 20
Polycarbonate PC
PUSH IN
1.5 ... 1.5 mm ²
1.5 ... 2.5 mm ²
1.5 ... 1.5 mm ²
1.5 ... 2.5 mm ²
1.5 ... 2.5 mm ²
10 mm
250 V
10 A
-5 °C...50 °C
GERMLLOYD

Type	Qty.	Order No.
IE-FCI-PWB-CH	1	1450780000

Type	Qty.	Order No.

France, white

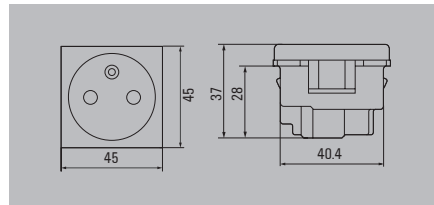

IP 20
Polycarbonate PC
PUSH IN
1.5 ... 1.5 mm ²
1.5 ... 2.5 mm ²
1.5 ... 1.5 mm ²
1.5 ... 2.5 mm ²
1.5 ... 2.5 mm ²
10 mm
250 V
16 A
-5 °C...50 °C
GERMLLOYD

Type	Qty.	Order No.
IE-FCI-PWB-FR	1	1450750000

Type	Qty.	Order No.

France, orange

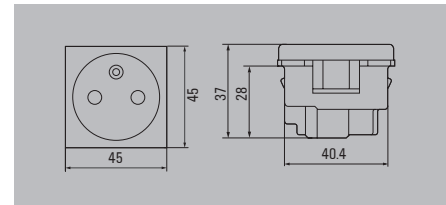

IP 20
Polycarbonate PC
PUSH IN
1.5 ... 1.5 mm ²
1.5 ... 2.5 mm ²
1.5 ... 1.5 mm ²
1.5 ... 2.5 mm ²
1.5 ... 2.5 mm ²
10 mm
250 V
16 A
-5 °C...50 °C

Type	Qty.	Order No.
IE-FCI-PWB-FR-OR	1	2007230000

Type	Qty.	Order No.

IP 65 service interface FrontCom® Vario

Power inserts

Sockets

- IP 20

UK

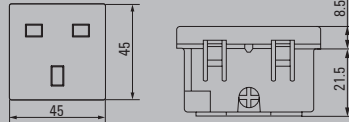

Italy

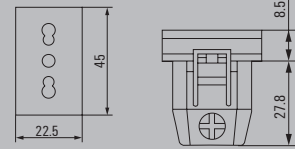

Technical data

Protection degree
 Housing main material
 Type of connection
 Line connection cross-section
 finely stranded with wire-end ferrule
 finely stranded without wire-end ferrule
 finely stranded with wire-end ferrule
 finely stranded without wire-end ferrule
 Conductor connection cross-section, rigid
 Stripping length
 Rated voltage (AC)
 Rated current
 Ambient temperature (operational)
 Approvals

IP 20
 Polycarbonate PC
 Screw connection
 1.5 ... 2.5 mm²
 1.5 ... 4 mm²
 1.5 ... 2.5 mm²
 1.5 ... 4 mm²
 1.5 ... 4 mm²
 9 mm
 250 V
 13 A
 -5 °C...50 °C
 GERMLLOYD

IP 20
 Polycarbonate PC
 Screw connection
 1.5 ... 2.5 mm²
 1.5 ... 4 mm²
 1.5 ... 2.5 mm²
 1.5 ... 4 mm²
 1.5 ... 4 mm²
 9 mm
 250 V
 16 A
 -5 °C...50 °C
 GERMLLOYD

Note

Ordering data

Type	Qty.	Order No.
IE-FCI-PWB-GB	1	1450770000

Type	Qty.	Order No.
IE-FCI-PWS-IT	1	1450810000

Note

Accessories

Type	Qty.	Order No.
------	------	-----------

Type	Qty.	Order No.
------	------	-----------

Note

Euro

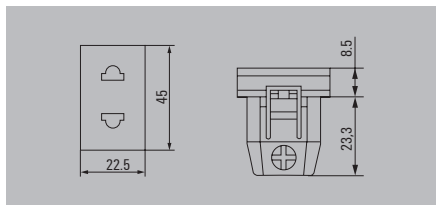

IP 20
Polycarbonate PC
Screw connection
1.5 ... 2.5 mm ²
1.5 ... 4 mm ²
1.5 ... 2.5 mm ²
1.5 ... 4 mm ²
1.5 ... 4 mm ²
9 mm
250 V
16 A
-5 °C...50 °C
GERMLLOYD

Type	Qty.	Order No.
IE-FCI-PWS-EU	1	1450740000

Type	Qty.	Order No.

Australia, 15 A

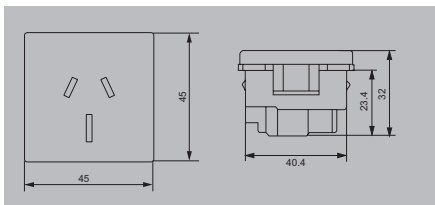

IP 20
Polycarbonate PC
Screw connection
1.5 ... 2.5 mm ²
1.5 ... 4 mm ²
1.5 ... 2.5 mm ²
1.5 ... 4 mm ²
1.5 ... 4 mm ²
9 mm
240 V
15 A
-5 °C...50 °C
GERMLLOYD

Type	Qty.	Order No.
IE-FCI-PWB-AU	1	1450830000

Type	Qty.	Order No.

Australia, 10 A

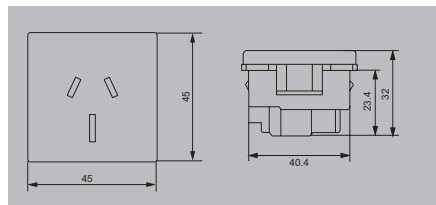

IP 20
Polycarbonate PC
Screw connection
1.5 ... 2.5 mm ²
1.5 ... 4 mm ²
1.5 ... 2.5 mm ²
1.5 ... 4 mm ²
1.5 ... 4 mm ²
9 mm
240 V
10 A
-5 °C...50 °C
GERMLLOYD

Type	Qty.	Order No.
IE-FCI-PWB-AU-10A	10	1546590000

Type	Qty.	Order No.

IP 65 service interface FrontCom® Vario

Power inserts

Sockets

- IP 20

China

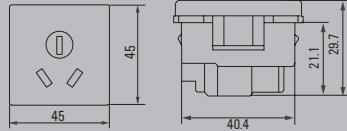

USA

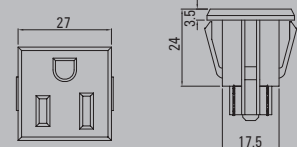

Technical data

Protection degree	IP 20
Housing main material	Polycarbonate PC
Type of connection	Screw connection
Line connection cross-section	1.5 ... 2.5 mm ²
finely stranded with wire-end ferrule	1.5 ... 4 mm ²
finely stranded without wire-end ferrule	1.5 ... 2.5 mm ²
finely stranded with wire-end ferrule	1.5 ... 4 mm ²
finely stranded without wire-end ferrule	1.5 ... 4 mm ²
Conductor connection cross-section, rigid	1.5 ... 4 mm ²
Stripping length	9 mm
Rated voltage (AC)	250 V
Rated current	10 A
Ambient temperature (operational)	-5 °C...50 °C
Approvals	GERMILLOYD
Note	

Protection degree	IP 20
Housing main material	Polycarbonate PC
Type of connection	Screw connection
Line connection cross-section	1.5 ... 2.5 mm ²
finely stranded with wire-end ferrule	1.5 ... 4 mm ²
finely stranded without wire-end ferrule	1.5 ... 2.5 mm ²
finely stranded with wire-end ferrule	1.5 ... 4 mm ²
finely stranded without wire-end ferrule	1.5 ... 4 mm ²
Conductor connection cross-section, rigid	1.5 ... 4 mm ²
Stripping length	9 mm
Rated voltage (AC)	250 V
Rated current	10 A
Ambient temperature (operational)	-5 °C...50 °C
Approvals	GERMILLOYD
Note	

Protection degree	IP 20
Housing main material	PA 66
Type of connection	Solder connection, FS 4.8 x 0.8
Line connection cross-section	
finely stranded with wire-end ferrule	
finely stranded without wire-end ferrule	
finely stranded with wire-end ferrule	
finely stranded without wire-end ferrule	
Conductor connection cross-section, rigid	
Stripping length	
Rated voltage (AC)	125 V
Rated current	15 A
Ambient temperature (operational)	-20 °C...85 °C
Approvals	GERMILLOYD
Note	

Ordering data

Type	Qty.	Order No.
IE-FCI-PWB-CN	1	1450790000

Type	Qty.	Order No.
IE-FCI-PWB-CN	1	1450790000

Type	Qty.	Order No.
IE-FCI-PWS-US	1	1450800000

For US socket the touch-safe protection is mandatory

Accessories

Type	Qty.	Order No.
Cable-lug sleeve		

Type	Qty.	Order No.

Type	Qty.	Order No.
VFSKHV/1,5-2,5/485	100	1491920000

Note

--

--

Multi-contact

EU, US, CN, GB, IND

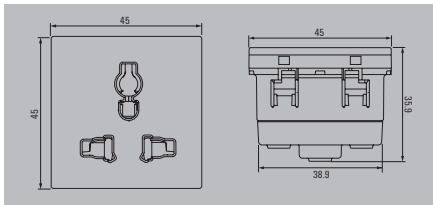

IP 20
Polycarbonate PC
Screw connection
1.5 ... 2.5 mm ²
1.5 ... 4 mm ²
1.5 ... 2.5 mm ²
1.5 ... 4 mm ²
1.5 ... 4 mm ²
10 mm
250 V / 127 V
5 A / 6 A / 10 A / 13 A / 15 A
-5 °C...50 °C
GERMLLOYD

Type	Qty.	Order No.
IE-FCI-PWB-MC	1	1529570000

Type	Qty.	Order No.

Power inserts

RCBO

- IP 20

RCBO

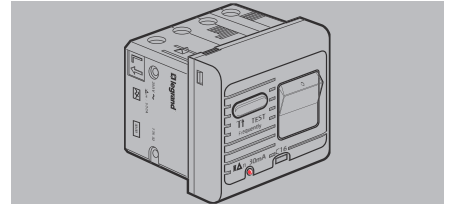
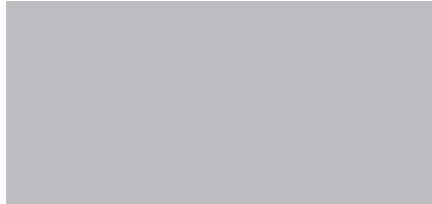
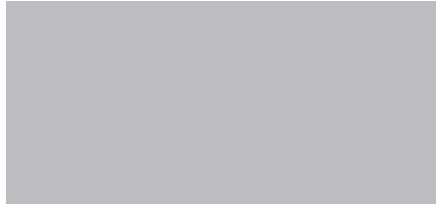

Technical data

Ambient temperature (operational)	-5 °C...40 °C
Operating voltage	230 V AC
Rated current	16 A
I Δ m	500 A
I Δ n	30 mA
Triggering characteristic	Typ C
Type of connection	Screw connection
Line connection cross-section	
finely stranded with wire-end ferrule	1.5 ... 2.5 mm ²
finely stranded with wire-end ferrule	1.5 ... 2.5 mm ²
Conductor connection cross-section, rigid	1.5 ... 2.5 mm ²
Note	

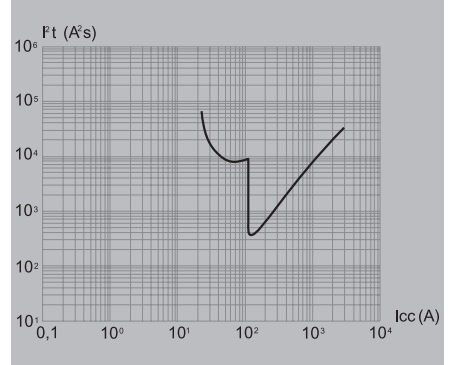

Ordering data

Type	Qty.	Order No.
IE-FCI-PWB-RCBO	1	1534250000
Note		

Accessories

Type	Qty.	Order No.

Note

3A fuse

- IP 20

3A fuse

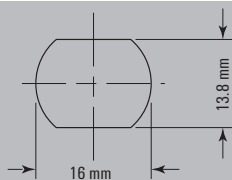

Technical data

Operating voltage	
Rated current	
Type of connection	
Note	

32 V DC, 250 V AC
3 A
Cable-lug sleeves 6.5 mm

Ordering data

Note

Type	Qty.	Order No.
IE-FCI-PWCB-3A	1	1543690000

Accessories

Cable-lug sleeves 6.5 mm	
	angled
	straight

Type	Qty.	Order No.
WFSKHV/1,5-2,5	100	1491970000
VFSKHV/1,5-2,5/638	100	1491940000

Note

--

Accessories

Touch-safe protection

Touch-safe protection

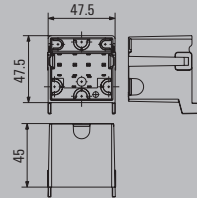

Technical data

Length x width x height	47.5 / 47.5 / 45 mm
Material	PC
Note	

Length x width x height	47.5 / 47.5 / 45 mm
Material	PC
Note	

Ordering data

Type	Qty.	Order No.
IE-FC-PWPC	1	1450820000
Note		

Type	Qty.	Order No.
IE-FC-PWPC	1	1450820000
Note		

Accessories

Type	Qty.	Order No.

Type	Qty.	Order No.

Note	
------	--

Note	
------	--

Sets

- shielded

2x Data 1x Power DE

Plastic cover



2x Data 1x Power MC

Metal cover, lockable

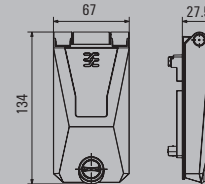
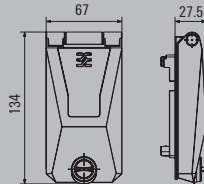

Technical data

Frame
 Insert plate
 Data inserts
 Power inserts
 Rated voltage for socket
 Rated current for socket
 Protection degree
 products included in the set

Plastic cover
 2x data, 1x power, Shielded
 USB 2.0 A/A, RJ45 coupling Cat.6_A
 Socket DE
 250 V
 16 A
 IP 65 in enclosed state
 1450510000;1450550000;1450730000;1019570000;
 1962840000

Metal cover, Lockable with key
 2x data, 1x power, Shielded
 2 x RJ45 coupling Cat.6_A
 Multicontact socket for: EU, US, CN, GB, IND
 127 V, 250 V
 15 A (at 127 V), 5 - 6 - 10 - 13 A (at 250 V)
 IP 65 in enclosed state
 1450540000;1450550000;1529570000;1962840000

Note

Ordering data

shielded
 unshielded

Note

Type	Qty.	Order No.
IE-FC-SET-SPDED001-KN-P	1	1529580000

Type	Qty.	Order No.
IE-FC-SET-SPMCD002-KY-M	1	1529390000

Accessories

Type	Qty.	Order No.

Type	Qty.	Order No.

Note

IP 65 service interface FrontCom® Vario

Sets

Incl. preprinted markers: „Service only!“, „USB“, „Ethernet“, „230 V / AC“

2x Data, 1x Power



2x Data, 1x Power



Technical data

Frame
Insert plate
Data inserts
Power inserts
Rated voltage for socket
Rated current for socket
Protection degree
products included in the set

Plastic cover, Lockable with key
2x data, 1x power, Shielded
USB 2.0 A/A, RJ45 coupling Cat.6 _A
Socket DE
250 V
16 A
IP 65 in enclosed state
1450520000;1450550000;1450730000;1019570000; 1962840000;1450820000

Plastic cover, Lockable with key
2x data, 1x power, Unshielded
USB 2.0 A/A, RJ45 coupling Cat.6 _A
Socket DE
250 V
16 A
IP 65 in enclosed state
1450520000;1450630000;1450730000;1019570000; 1962840000;1450820000

Note

Ordering data

shielded
unshielded

Note

Type	Qty.	Order No.
IE-FC-SET-SPDEK001-KY-P	1	1989020000

Type	Qty.	Order No.
IE-FC-SET-IPDEK001-KY-P	1	1543680000

Accessories

Type	Qty.	Order No.

Type	Qty.	Order No.

Type	Qty.	Order No.

Note

Note

Note

FrontCom® Micro RJ45 Module

8-wire

4-wire

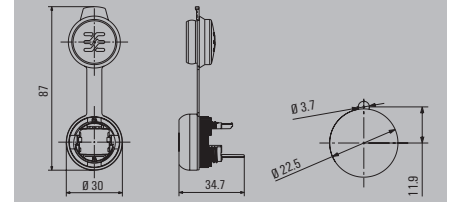
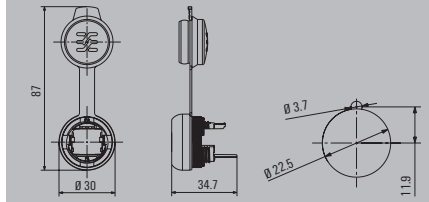

Technical data

Category	
Protection degree	
Housing main material	
Contact surface	
Colour	
Shielding	
Type of mounting	
Plugging cycles	
Connector standard	
Connection 1 / 2	
Wall thickness, min. / max.	
Dust protection cap material	
PoE / PoE+	
Ambient temperature (operational)	
Approvals	
Note	

Cat.6 _n / Class E _n (ISO/IEC 11801 2010)	
IP 65 according to DIN EN 60529	
PA UL 94 V0	
Gold over nickel	
Black	
360° shield contact	
Cabinet, Distribution box	
750	
IEC 60603-7-51	
RJ45 / IDC	
1 mm / 3 mm	
EPDM	
conforming to IEEE 802.3af	
-40 °C...70 °C	
CULUS	
Note	

Cat.5 (ISO/IEC 11801)	
IP 65 according to DIN EN 60529	
PA UL 94 V0	
Gold over nickel	
Black	
360° shield contact	
Cabinet, Distribution box	
750	
IEC 60603-7-51	
RJ45 / IDC	
1 mm / 3 mm	
EPDM	
conforming to IEEE 802.3af	
-40 °C...70 °C	
CULUS	
Note	



Ordering data

PROFINET module	
TIA-A module	
TIA-B module	
Note	

Type	Qty.	Order No.
IE-FCM-RJ45-FJ-A	10	1018810000
IE-FCM-RJ45-FJ-B	10	1018820000
Note		

Type	Qty.	Order No.
IE-FCM-RJ45-FJ-P	10	1018830000
Note		

Accessories

Fixing tool	
Markers	
	SwitchMark markers white
	SwitchMark holder
Note	

Type	Qty.	Order No.
IE-FISP-V4	2	9204370000
SM 27/18 MC NE WS	80	1699860000
SM-H 27/18 SW	25	1716630000
Note		

Type	Qty.	Order No.
IE-FISP-V4	2	9204370000
SM 27/18 MC NE WS	80	1699860000
SM-H 27/18 SW	25	1716630000
Note		

Note	
-------------	--

Note	
-------------	--

Note	
-------------	--

**FrontCom® Micro RJ45
Coupling**

8-wire

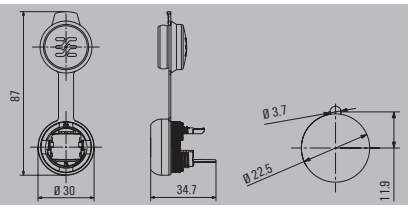

Technical data

Category	Cat.6 _n / Class E _n (ISO/IEC 11801 2010)
Protection degree	IP 65 according to DIN EN 60529
Housing main material	PA UL 94 V0
Contact surface	Gold over nickel
Colour	Black
Shielding	360° shield contact
Type of mounting	Cabinet, Distribution box
Plugging cycles	750
Connector standard	IEC 60603-7-51
Connection 1 / 2	RJ45 / RJ45
Wall thickness, min. / max.	1 mm / 3 mm
Dust protection cap material	EPDM
PoE / PoE+	conforming to IEEE 802.3af
Ambient temperature (operational)	-40 °C...70 °C
Approvals	CULUS
Note	

Ordering data

Type	Qty.	Order No.
IE-FCM-RJ45-C	10	1018790000

Accessories

Type	Qty.	Order No.
IE-FISP-V4	2	9204370000
SM 27/18 MC NE WS	80	1699860000
SM-H 27/18 SW	25	1716630000

Fixing tool	Markers
	SwitchMark markers white SwitchMark holder

Note

IP 65 service interface FrontCom® Micro

FrontCom® Micro USB

Coupling AA

Coupling AB

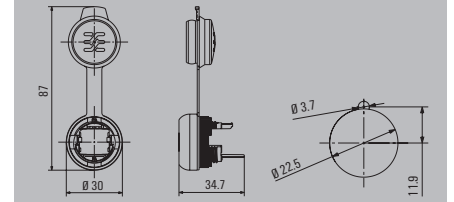
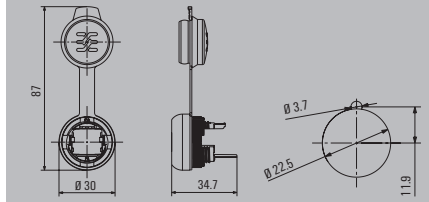

Technical data

Ambient temperature (operational)
Protection degree
Housing main material
Colour
Shielding
Type of mounting
Connector standard
Connection 1 / 2
Dust protection cap material
Wall thickness, min. / max.
Approvals
Note

-40 °C...70 °C
IP 65 according to DIN EN 60529
PA UL 94 V0
Black
360° shield contact
Cabinet, Distribution box
IEC 61076-3-107
USB A / USB A
EPDM
1 mm / 3 mm
CULUS
Approvals available on request

-40 °C...70 °C
IP 65 according to DIN EN 60529
PA UL 94 V0
Black
360° shield contact
Cabinet, Distribution box
IEC 61076-3-107
USB A / USB B
EPDM
1 mm / 3 mm
CULUS

Ordering data

USB 2.0
USB 3.0
Note

Type	Qty.	Order No.
IE-FCM-USB-A	10	1018840000
IE-FCM-USB-3.0-A	10	1427960000

Type	Qty.	Order No.
IE-FCM-USB-AB	10	1222550000

Accessories

Fixing tool
Markers
 SwitchMark markers white
SwitchMark holder
USB cable
0.5 m
1.0 m
1.5 m
1.8 m
3.0 m

Type	Qty.	Order No.
IE-FISP-V4	2	9204370000
SM 27/18 MC NE WS	80	1699860000
SM-H 27/18 SW	25	1716630000
IE-USB-A-A-0.5M	1	1993550005
IE-USB-A-A-1.0M	1	1993550010
IE-USB-A-A-1.5M	1	1993550015
IE-USB-A-A-1.8M	1	1993550018
IE-USB-A-A-3.0M	1	1993550030

Type	Qty.	Order No.
IE-FISP-V4	2	9204370000
SM 27/18 MC NE WS	80	1699860000
SM-H 27/18 SW	25	1716630000

Note

Note

Note

IP 67 plug-in connectors

Overview

IP 67 plug-in connectors	PushPull V14 - RJ45	J.2
	PushPull V14 - Hybrid	J.6
	PushPull V14 - FO	J.10
	Bayonet V1 Metal-RJ45	J.12
	Bayonet V1 Metal-FO	J.14
	Bayonet V1 Plastic-RJ45	J.18
	PushPull V4 - RJ45	J.22
	PushPull V4 - FO	J.26
	RockStar® V5 - RJ45	J.30
	SnapIn V6 - RJ45	J.32
	M12 D-coded	J.36
	M12 X-Type	J.41
	Inserts	J.46
	PushPull Power	J.58

PushPull V14 - RJ45

Plug PushPull V14 - RJ45

- 4- and 8-wire, RJ45 plug field attachable with colour coding on the plug

without anti-kink prevention, 4-wire

PROFINET printing

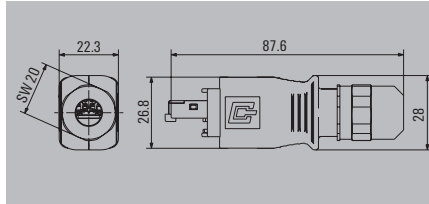

Technical data

Category
Protection degree
Housing main material
Contact surface
Sheath diameter, min. / max.
Plugging cycles
Ambient temperature (operational)
Connector standard
Connection diameter, flexible, min. / max.
Connection cross-section, flexible, min. / max.
Connection diameter, solid, min. / max.
Connection cross-section, solid, min. / max.
Approvals

Cat.5 (ISO/IEC 11801)
IP 67
Zinc diecast
Gold over nickel
5 mm / 10 mm
750
-40 °C...70 °C
IEC 61076-3-117 Var. 14, IEC 60603-7-51
0.48 mm / 0.76 mm
AWG 26 / AWG 22
0.4 mm / 0.64 mm
AWG 24 / AWG 22
EAC

Note Other approvals for individual parts of the set available

Ordering data - Sets

Type	Qty.	Order No.
IE-PS-V14M-RJ45-FHP	10	1012170000

Note RJ45 tool-free

Ordering data - Empty housings

Type	Qty.	Order No.
IE-PH-V14M-RJ	10	1011560000

Note

Accessories

Type	Qty.	Order No.
IE-PP-V14P	10	1058280000

Dust protection cap



Note Plug inserts can also be ordered separately. Refer to Inserts.

**PushPull V14 - RJ45 flange
Module**

4-wire

PROFINET printing

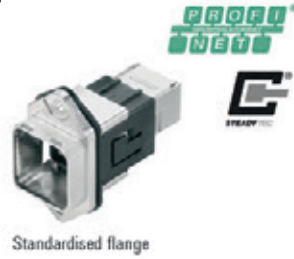

Standardised flange

8-wire

TIA-A

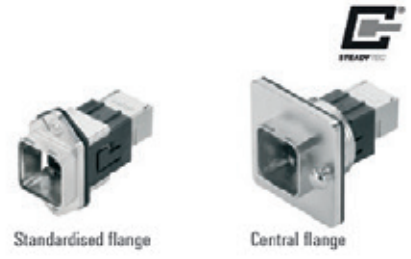

Standardised flange

Central flange

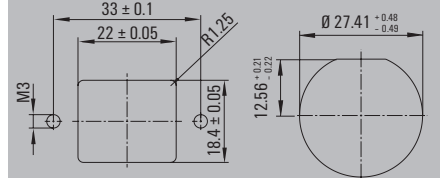
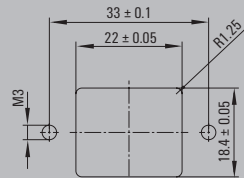

Technical data

Category
Protection degree
Housing main material
Contact surface
Sheath diameter, min. / max.
Plugging cycles
Ambient temperature (operational)
Connector standard
Connection diameter, flexible, min. / max.
Connection cross-section, flexible, min. / max.
Connection diameter, solid, min. / max.
Connection cross-section, solid, min. / max.
Approvals

Cat.5 (ISO/IEC 11801)
IP 67
Zinc diecast
Gold over nickel
5 mm / 10 mm
750
-40 °C...70 °C
IEC 61076-3-117 Var. 14, IEC 60603-7-51
0.48 mm / 0.76 mm
AWG 26 / AWG 22
0.4 mm / 0.64 mm
AWG 24 / AWG 22

Cat.6 _A / Class E _A (ISO/IEC 11801 2010)
IP 67
Zinc diecast
Gold over nickel
5 mm / 10 mm
750
-40 °C...70 °C
IEC 61076-3-117 Var. 14, IEC 60603-7-51
0.48 mm
AWG 26 / AWG 22
0.4 mm / 0.64 mm
AWG 24 / AWG 22

Note Other approvals for individual parts of the set available

Note Other approvals for individual parts of the set available

Ordering data - Sets

Standardised flange
Central flange

Type	Qty.	Order No.
IE-BSS-V14M-RJ45-FJ-P	10	1085260000

Type	Qty.	Order No.
IE-BSS-V14M-RJ45-FJ-A	10	1012320000
IE-BSC-V14M-RJ45-FJ-A	10	1058270000

Note

Ordering data - Empty housings

Standardised flange
Central flange
Device flange

Type	Qty.	Order No.
IE-BHS-V14M-RJA	10	1011540000
IE-BHC-V14M-RJA	10	1047950000
IE-BHD-V14M	10	1047940000

Type	Qty.	Order No.
IE-BHS-V14M-RJA	10	1011540000
IE-BHC-V14M-RJA	10	1047950000
IE-BHD-V14M	10	1047940000

Note

Accessories

Dust protection cap



Type	Qty.	Order No.
IE-BP-V14P	10	1058310000

Type	Qty.	Order No.
IE-BP-V14P	10	1058310000

Note Plug inserts can also be ordered separately. Refer to Inserts.

Note Plug inserts can also be ordered separately, see Inserts

PushPull V14 - RJ45

**PushPull V14 - RJ45 flange
Coupling**

8-wire

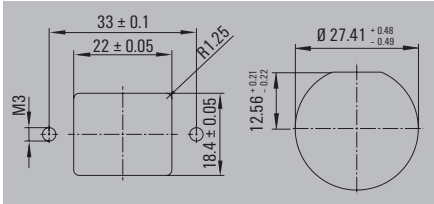
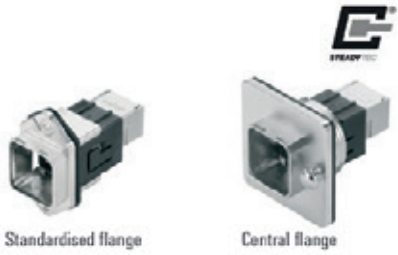

Technical data

Category	Cat.6 _n / Class E _n (ISO/IEC 11801 2010)
Protection degree	IP 67
Housing main material	Zinc diecast
Contact surface	Gold over nickel
Sheath diameter, min. / max.	5 mm / 10 mm
Plugging cycles	750
Ambient temperature (operational)	-40 °C...70 °C
Connector standard	IEC 61076-3-117 Var. 14, IEC 60603-7-51
Connection diameter, flexible, min. / max.	
Connection cross-section, flexible, min. / max.	
Connection diameter, solid, min. / max.	
Connection cross-section, solid, min. / max.	
Approvals	
Note	Other approvals for individual parts of the set available

Ordering data - Sets

	Standardised flange		
	Central flange		
Note			
	Type	Qty.	Order No.
	IE-BSS-V14M-RJ45-C	10	1012310000
	IE-BSC-V14M-RJ45-C	10	1058250000

Ordering data - Empty housings

	Standardised flange		
	Central flange		
	Device flange		
Note			
	Type	Qty.	Order No.
	IE-BHS-V14M-RJA	10	1011540000
	IE-BHC-V14M-RJA	10	1047950000
	IE-BHD-V14M	10	1047940000

Accessories

Dust protection cap			
	Type	Qty.	Order No.
	IE-BP-V14P	10	1058310000

Note	Plug inserts can also be ordered separately. Refer to Inserts.
-------------	--

Flange-mounted empty housing / PushPull device flange V14

- IP 67

Empty housing

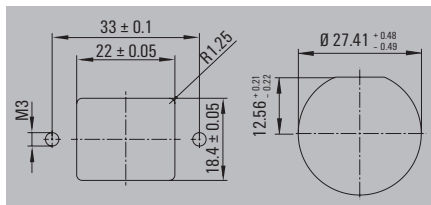
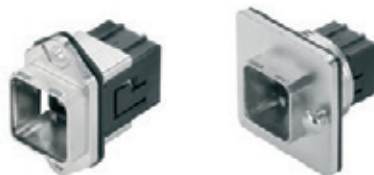

Device flange

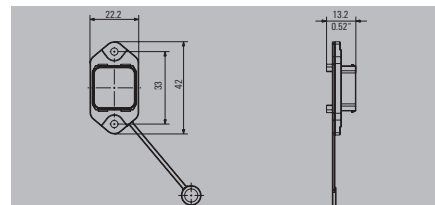

Technical data

Category
Protection degree
Housing main material
Contact surface
Sheath diameter, min. / max.
Plugging cycles
Ambient temperature (operational)
Connector standard
Connection diameter, flexible, min. / max.
Connection cross-section, flexible, min. / max.
Connection diameter, solid, min. / max.
Connection cross-section, solid, min. / max.
Approvals
Note

IP 67
Zinc diecast
750
-40 °C...70 °C
IEC 61076-3-117 Var. 14
Note

IP 67
Zinc diecast
750
-40 °C...70 °C
IEC 61076-3-117 Var. 14
Note

Ordering data

Standardised flange
Central flange
Device flange
Note

Type	Qty.	Order No.
IE-BHS-V14M-RJA	10	1011540000
IE-BHC-V14M-RJA	10	1047950000
Note		

Type	Qty.	Order No.
IE-BHD-V14M	10	1047940000
Note		

Accessories

Dust protection cap
Note

Type	Qty.	Order No.
IE-BP-V14P	10	1058310000
Note		

Type	Qty.	Order No.
IE-BP-V14P	10	1058310000
Note		

Note

Plug inserts can also be ordered separately. Refer to Inserts.

Plug inserts can also be ordered separately. Refer to Inserts.

PushPull V14 - Hybrid

Plug PushPull V14 - Hybrid

Without kink prevention

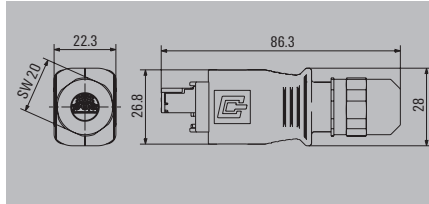

Technical data

Category
Protection degree
Housing main material
Contact surface
Sheath diameter, min. / max.
Plugging cycles
Ambient temperature (operational)
Connection 1 / 2
Connector standard
Connection cross-section, flexible, min. / max.
Connection diameter, flexible, min. / max.
Rated current (hybrid connector)
Volume resistance
Approvals
Note

Cat.5 (ISO/IEC 11801)
IP 67
Zinc diecast
Gold over nickel
5 mm / 10 mm
500
-40 °C...70 °C
Hybrid (Q10) / Crimp
IEC 61076-3-117 Var. 14
AWG 27 / AWG 20
0.08 mm ² / 0.75 mm ²
3 A per contact
< 10 mΩ
EAC
Other approvals for individual parts of the set available

Ordering data - Sets

Note





Type	Qty.	Order No.
IE-PS-V14M-HYB-10P	10	1072910000
Order contacts separately		

Ordering data - Empty housings

Note

Type	Qty.	Order No.
IE-PH-V14M-RJ	10	1011560000

Accessories

Crimp contacts	
	0.08...0.2 mm ²
	0.2...0.5 mm ²
	0.75 mm ²
Crimping tool	
	
Cable	Hybrid cable
	
Dust protection cap	
	
Note	

Type	Qty.	Order No.
IE-PIC-HYB-S-0,2-300	300	1135150000
IE-PIC-HYB-S-0,5-300	300	1096180000
IE-PIC-HYB-S-0,75-300	300	1068950000
HTF HYB	1	1119580000
IE-C5DHAG-MW		1172250000
IE-PP-V14P	10	1058280000
Plug inserts can also be ordered separately. Refer to Inserts.		

Flange PushPull V14 - Hybrid

Standardised flange

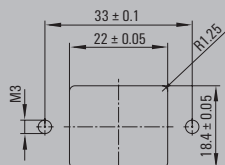

Technical data

Category
Protection degree
Housing main material
Seal material
Contact surface
Sheath diameter, min. / max.
Plugging cycles
Ambient temperature (operational)
Connection 1 / 2
Connector standard
Connection cross-section, flexible, min. / max.
Connection diameter, flexible, min. / max.
Rated current (hybrid connector)
Volume resistance
Approvals
Note

Cat.5 (ISO/IEC 11801)
IP 67
Zinc diecast
EPDM
Gold over nickel
5 mm / 10 mm
500
-40 °C...70 °C
Hybrid (Q10) / Crimp
IEC 61076-3-117 Var. 14
AWG 27 / AWG 20
0.08 mm ² / 0.75 mm ²
3 A per contact
< 10 mΩ
Other approvals for individual parts of the set available

Ordering data - Sets

Note

Type	Qty.	Order No.
IE-BSS-V14M-HYB-10P-FJ	10	1072900000
Order contacts separately		

Ordering data - Empty housings

Standardised flange
Note

Type	Qty.	Order No.
IE-BHS-V14M-RJA	10	1011540000

Accessories

Crimp contacts	
	0.08...0.2 mm ²
	0.2...0.5 mm ²
	0.75 mm ²
Crimping tool	
Cable	Hybrid cable
Dust protection cap	
Note	

Type	Qty.	Order No.
IE-BIC-HYB-P-0,2-300	300	1135160000
IE-BIC-HYB-P-0,5-300	300	1096150000
IE-BIC-HYB-P-0,75-300	300	1068970000
HTF HYB	1	1119580000
IE-C5DHAG-MW		1172250000
IE-BP-V14P	10	1058310000
Plug inserts can also be ordered separately. Refer to Inserts.		



V14 flange adapter

Straight

Angled

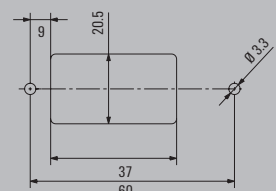
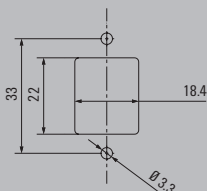

Technical data

Protection degree
Housing main material
Seal material
Type of mounting
Ambient temperature (operational)
Note

IP 67
Zinc diecast
EPDM
2 screws, M3 (not included)
-40...70 °C
Note

IP 67
Zinc diecast
EPDM
2 screws, M3 (not included)
-40...70 °C
Note

Ordering data

Note

Type	Qty.	Order No.
IE-AD-BHS-V14M-RJA	1	1302000000
Flange and plug inserts must be ordered separately, see Inserts/Flanges		

Type	Qty.	Order No.
IE-BHS-V14M-RJA-45	10	1296710000
Flange inserts must be ordered separately, see Inserts		

Accessories

--

Type	Qty.	Order No.

Type	Qty.	Order No.

Note

--

--

PushPull V14 - FO

PushPull V14 plug - fibre-optic

Without kink prevention

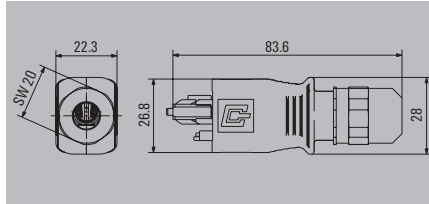

Technical data

Protection degree
Housing main material
Sheath diameter, min. / max.
Plugging cycles
Ambient temperature (operational)
Connector standard
Approvals
Note

IP 67
Zinc diecast
5 mm / 10 mm
750
-40...70 °C
IEC 61076-3-117 Var. 14, IEC 61754-24
EAC

Ordering data - Sets

	POF
Note	

Type	Qty.	Order No.
IE-PS-V14M-2SC-POF	10	1191550000

Ordering data - Empty housings

Note

Type	Qty.	Order No.
IE-PH-V14M-FO	10	1058100000

Accessories

Inserts	
	Singlemode
	Multimode
	POF

Dust protection cap	
	

Tools	
	POF tool set
	Fibre-optic tool case

Replacement ferrule	
	

Type	Qty.	Order No.
IE-PI-SCRJ-SM	10	1067390000
IE-PI-SCRJ-MM	10	1067380000
IE-PI-SCRJ-POF	10	1067410000
IE-PP-V14P	10	1058280000
TOOL SET IE-POF	1	1208930000
IE-CTC-SCST-GOF	1	1032030000
IE-SCRJJP67-POF-100	100	1278430000

Note

Plug inserts can also be ordered separately, see Inserts
--

Flange PushPull V14 - fibre-optic

SC-RJ

LC Duplex

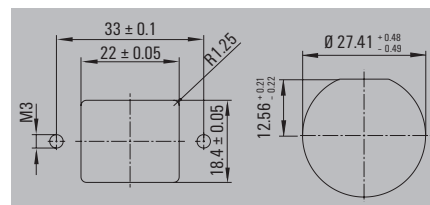
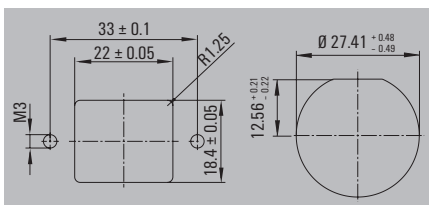
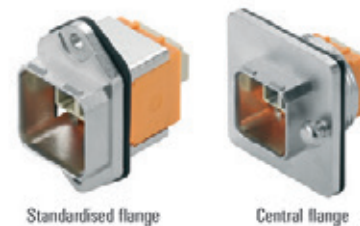
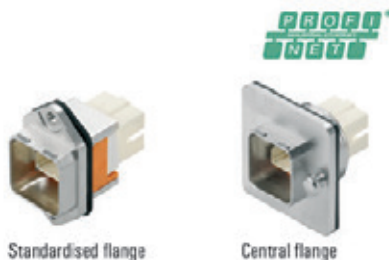

Technical data

Protection degree
Housing main material
Plugging cycles
Ambient temperature (operational)
Insertion loss
Connector standard
Approvals
Note

IP 67
Zinc diecast
500
-40 °C...70 °C
≤ 0.5 dB
IEC 61076-3-117 Var. 14, IEC 61754-24
Note

IP 67
Zinc diecast
500
-40 °C...70 °C
≤ 0.4 dB
IEC 61076-3-117 Var. 14, IEC 61754-20
Note

Ordering data - Sets

Central flange Singlemode
Standardised flange Singlemode
Central flange Multimode
Standardised flange Multimode
Note

Type	Qty.	Order No.
IE-BSC-V14M-SCRJ-SM-C	10	1062600000
IE-BSS-V14M-SCRJ-SM-C	10	1058140000
IE-BSC-V14M-SCRJ-MM-C	10	1062590000
IE-BSS-V14M-SCRJ-MM-C	10	1058120000
Note		

Type	Qty.	Order No.
IE-BSC-V14M-LCD-SM-C	10	1062620000
IE-BSS-V14M-LCD-SM-C	10	1058150000
IE-BSC-V14M-LCD-MM-C	10	1062610000
IE-BSS-V14M-LCD-MM-C	10	1058130000
Note		

Ordering data - Empty housings

Device flange
Note

Type	Qty.	Order No.
IE-BHD-V14M	10	1047940000
Note		

Type	Qty.	Order No.
IE-BHD-V14M	10	1047940000
Note		

Accessories

Dust protection cap

Note

Type	Qty.	Order No.
IE-BP-V14P	10	1058310000
Note		

Type	Qty.	Order No.
IE-BP-V14P	10	1058310000
Note		

Note

Plug inserts can also be ordered separately. Refer to Inserts.

Plug inserts can also be ordered separately. Refer to Inserts.

Bayonet V1 Metal - RJ45

Plug bayonet V1 Metal - RJ45

Without kink prevention

With kink prevention

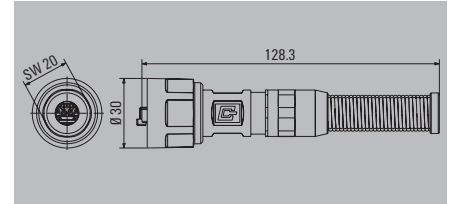
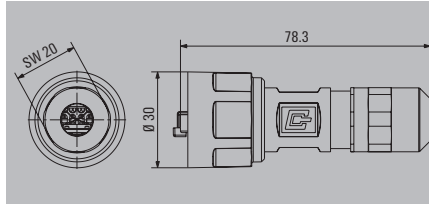

Technical data

Category
Protection degree
Housing main material
Contact surface
Sheath diameter, min. / max.
Plugging cycles
Ambient temperature (operational)
Connection cross-section, flexible, min. / max.
Connection diameter, flexible, min. / max.
Connection cross-section, solid, min. / max.
Connection diameter, solid, min. / max.
Connector standard
Approvals
Note

Cat.6 _n / Class E _n (ISO/IEC 11801 2010)
IP 67
Zinc diecast
Gold over nickel
5 mm / 10 mm
750
-40 °C...70 °C
AWG 26 / AWG 22
0.48 mm / 0.76 mm
AWG 24 / AWG 22
0.4 mm / 0.64 mm
IEC 61076-3-106 Var. 1, IEC 60603-7-51
CULUS; EAC

Cat.6 _n / Class E _n (ISO/IEC 11801 2010)
IP 67
Zinc diecast
Gold over nickel
5 mm / 10 mm
750
-40 °C...70 °C
AWG 26 / AWG 22
0.48 mm / 0.76 mm
AWG 24 / AWG 22
0.4 mm / 0.64 mm
IEC 61076-3-106 Var. 1, IEC 60603-7-51
CULUS; EAC

Ordering data - Sets

RJ45 tool-free. AWG 26-22. TIA-A/B-PROFINET
RJ45 Crimp. AWG 27-24
Note

Type	Qty.	Order No.
IE-PS-V01M-RJ45-FH	10	1963120000
IE-PS-V01M-RJ45-TH	10	1963140000

Type	Qty.	Order No.
IE-PS-V01M-RJ45-FH-BP	10	1963130000
IE-PS-V01M-RJ45-TH-BP	10	1963150000

Ordering data - Empty housings

Note

Type	Qty.	Order No.
IE-PH-V01M	10	1962550000

Type	Qty.	Order No.
IE-PH-V01M-BP	10	1962560000

Accessories

Dust protection cap	Plug housing protective cap
----------------------------	-----------------------------



Type	Qty.	Order No.
IE-PP-V01P	10	1965690000

Type	Qty.	Order No.
IE-PP-V01P	10	1965690000

Note

Plug inserts can also be ordered separately. Refer to Inserts.

Plug inserts can also be ordered separately. Refer to Inserts.

Flange bayonet V1 Metal - RJ45

Module

Coupling

TIA-A

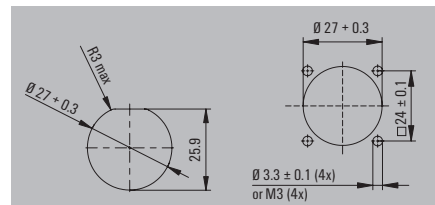
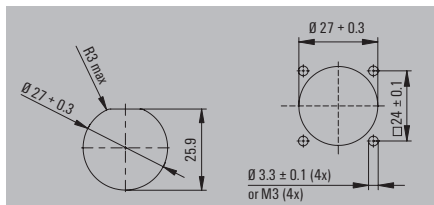

Technical data

Category	
Protection degree	IP 67
Housing main material	Zinc diecast
Contact surface	Gold over nickel
Plugging cycles	750
Ambient temperature (operational)	-40 °C...70 °C
Connector standard	IEC 61076-3-106 Var. 1, IEC 60603-7-51
Connection cross-section, flexible, min. / max.	AWG 26 / AWG 22
Connection diameter, flexible, min. / max.	0.48 mm / 0.76 mm
Connection cross-section, solid, min. / max.	AWG 24 / AWG 22
Connection diameter, solid, min. / max.	0.4 mm / 0.64 mm
Approvals	CULUS
Note	

Cat.6 _n / Class E _n (ISO/IEC 11801 2010)	
IP 67	
Zinc diecast	
Gold over nickel	
750	
-40 °C...70 °C	
IEC 61076-3-106 Var. 1, IEC 60603-7-51	
AWG 26 / AWG 22	
0.48 mm / 0.76 mm	
AWG 24 / AWG 22	
0.4 mm / 0.64 mm	
CULUS	
Note	

Cat.6 _n / Class E _n (ISO/IEC 11801 2010)	
IP 67	
Zinc diecast	
Gold over nickel	
750	
-40 °C...70 °C	
IEC 61076-3-106 Var. 1, IEC 60603-7-51	
CULUS	
Note	

Ordering data - Sets

Note	
------	--

Type	Qty.	Order No.
IE-BS-V01M-RJ45-FJ-A	10	1963480000

Type	Qty.	Order No.
IE-BS-V01M-RJ45-C	10	1963470000

Ordering data - Empty housings

Note	
------	--

Type	Qty.	Order No.
IE-BH-V01M	10	1963540000

Type	Qty.	Order No.
IE-BH-V01M	10	1963540000

Accessories

Dust protection cap	
 Flange-mounted housing protective cap	

Type	Qty.	Order No.
IE-BP-V01P	10	1965700000

Type	Qty.	Order No.
IE-BP-V01P	10	1965700000

Note

Plug inserts can also be ordered separately. Refer to Inserts.

Plug inserts can also be ordered separately. Refer to Inserts.

Bayonet V1 Metal-F0

Plug bayonet V1 metal - fibre-optic-SC

Without kink prevention

With kink prevention

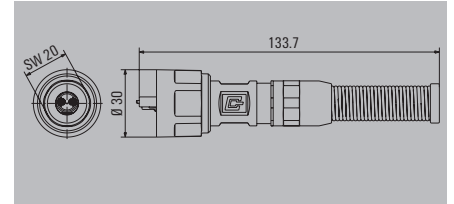
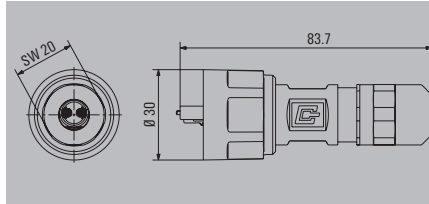

Technical data

Protection degree
Housing main material
Sheath diameter, min. / max.
Plugging cycles
Ambient temperature (operational)
Connector standard
Insertion loss
Return loss (attenuation)
Approvals
Note

IP 67
Zinc diecast
5 mm / 10 mm
500
-40 °C...70 °C
IEC 61076-3-106 Var. 1, IEC 61754-24
0.5 dB singlemode; 0.4 dB multimode; 1.5 dB POF
40 dB singlemode; 30 dB multimode
EAC

IP 67
Zinc diecast
5 mm / 10 mm
500
-40 °C...70 °C
IEC 61076-3-106 Var. 1, IEC 61754-24
0.5 dB singlemode; 0.4 dB multimode; 1.5 dB POF
40 dB singlemode; 30 dB multimode
EAC

Ordering data - Sets

Singlemode
Multimode
Note

Type	Qty.	Order No.
IE-PS-V01M-2SC-SM	10	1963300000
IE-PS-V01M-2SC-MM	10	1963260000

Type	Qty.	Order No.
IE-PS-V01M-2SC-SM-BP	10	1963310000
IE-PS-V01M-2SC-MM-BP	10	1963270000

Ordering data - Empty housings

Note

Type	Qty.	Order No.
IE-PH-V01M	10	1962550000

Type	Qty.	Order No.
IE-PH-V01M-BP	10	1962560000

Accessories

Tools
Fibre-optic tool case
POF tool set
Dust protection cap
Plug housing protective cap

Type	Qty.	Order No.
IE-CTC-SCST-GOF	1	1032030000
TOOL SET IE-POF	1	1208930000
IE-PP-V01P	10	1965690000

Type	Qty.	Order No.
IE-CTC-SCST-GOF	1	1032030000
TOOL SET IE-POF	1	1208930000
IE-PP-V01P	10	1965690000

Note

Plug inserts can also be ordered separately. Refer to Inserts.

Plug inserts can also be ordered separately. Refer to Inserts.

Flange bayonet V1 metal - fibre-optic-SC

Standardised flange

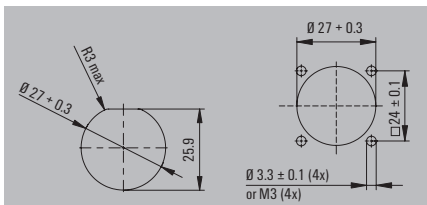

Technical data

Protection degree
Housing main material
Plugging cycles
Ambient temperature (operational)
Connector standard
Approvals
Note

IP 67
Zinc diecast
500
-40 °C...70 °C
IEC 61076-3-106 Var. 1, IEC 61754-24
Note

Ordering data - Sets

Singlemode
Multimode
Note

Type	Qty.	Order No.
IE-BS-V01M-SCRJ-SM	10	1221020000
IE-BS-V01M-SCRJ-MM	10	1221010000
Note		

Ordering data - Empty housings

Note

Type	Qty.	Order No.
IE-BHD-V01M-SCA	10	1221030000
Note		

Accessories

Dust protection cap
Flange-mounted housing protective cap

Note

Type	Qty.	Order No.
IE-BP-V01P	10	1965700000
Note		

Note

Plug inserts can also be ordered separately. Refer to Inserts.

Bayonet V1 Metal-F0

Plug bayonet V1 metal - fibre-optic-LC

Without kink prevention

With kink prevention

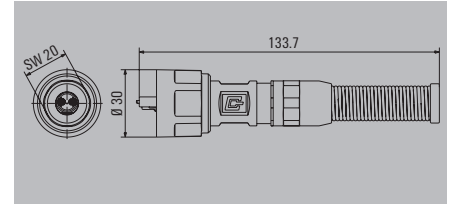
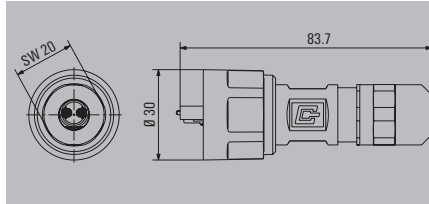

Technical data

Protection degree
Housing main material
Sheath diameter, min. / max.
Plugging cycles
Ambient temperature (operational)
Connector standard
Insertion loss
Return loss (attenuation)
Approvals
Note

IP 67
Zinc diecast
5 mm / 10 mm
500
-40 °C...70 °C
IEC 61076-3-106 Var. 1, IEC 61754-20
0.5 dB singlemode, 0.4 dB multimode
40 dB singlemode; 30 dB multimode
EAC
Note

IP 67
Zinc diecast
5 mm / 10 mm
500
-40 °C...70 °C
IEC 61076-3-106 Var. 1, IEC 61754-20
0.5 dB singlemode, 0.4 dB multimode
40 dB singlemode; 30 dB multimode
EAC
Note

Ordering data - Sets

Singlemode
Multimode
Note

Type	Qty.	Order No.
IE-PS-V01M-2LC-SM	10	1963240000
IE-PS-V01M-2LC-MM	10	1963220000
Note		

Type	Qty.	Order No.
IE-PS-V01M-2LC-SM-BP	10	1963250000
IE-PS-V01M-2LC-MM-BP	10	1963230000
Note		

Ordering data - Empty housings

Note

Type	Qty.	Order No.
IE-PH-V01M	10	1962550000
Note		

Type	Qty.	Order No.
IE-PH-V01M-BP	10	1962560000
Note		

Accessories

Tools
Fibre-optic tool case
Accessory set for LC plugs
Dust protection cap
Plug housing protective cap

Type	Qty.	Order No.
IE-CTC-SCST-GOF	1	1032030000
IE-CTC-AS-LC-GOF	1	1033350000
IE-PP-V01P	10	1965690000
Note		

Type	Qty.	Order No.
IE-CTC-SCST-GOF	1	1032030000
IE-CTC-AS-LC-GOF	1	1033350000
IE-PP-V01P	10	1965690000
Note		

Note

Plug inserts can also be ordered separately. Refer to Inserts.

Plug inserts can also be ordered separately. Refer to Inserts.

Flange bayonet V1 metal - fibre-optic-LC

Standardised flange

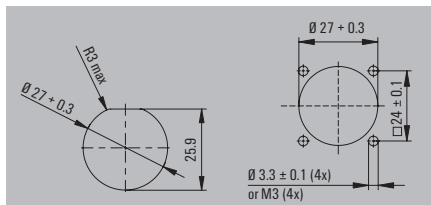

Technical data

Protection degree
Housing main material
Plugging cycles
Ambient temperature (operational)
Connector standard
Approvals
Note

IP 67
Zinc diecast
500
-40 °C...70 °C
IEC 61076-3-106 Var. 1, IEC 61754-20
Note

Ordering data - Sets

Singlemode
Multimode
Note

Type	Qty.	Order No.
IE-BS-V01M-LCD-SM-C	10	1963430000
IE-BS-V01M-LCD-MM-C	10	1964440000
Note		

Ordering data - Empty housings

Note

Type	Qty.	Order No.
IE-BH-V01M	10	1963540000
Note		

Accessories

Dust protection cap
Flange-mounted housing protective cap

Note

Type	Qty.	Order No.
IE-BP-V01P	10	1965700000
Note		

Note

Plug inserts can also be ordered separately. Refer to Inserts.

Bayonet V1 Plastic - RJ45

Plug bayonet V1 Plastic - RJ45

Without kink prevention

With kink prevention

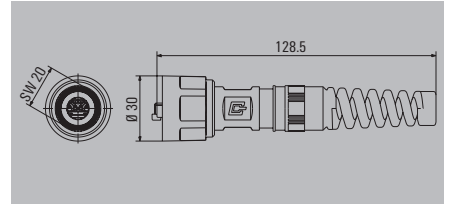
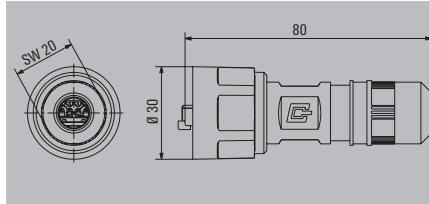

Technical data

Category
Protection degree
Housing main material
Contact surface
Sheath diameter, min. / max.
Plugging cycles
Ambient temperature (operational)
Connection cross-section, flexible, min. / max.
Connection diameter, flexible, min. / max.
Connection cross-section, solid, min. / max.
Connection diameter, solid, min. / max.
Connector standard
Approvals
Note

Cat.6 _n / Class E _n (ISO/IEC 11801 2010)
IP 67
PA UL 94 V0
Gold over nickel
5 mm / 10 mm
750
-40 °C...70 °C
AWG 26 / AWG 22
0.48 mm / 0.76 mm
AWG 24 / AWG 22
0.4 mm / 0.64 mm
IEC 61076-3-106 Var. 1, IEC 60603-7-51
CULUS; EAC
Note

Cat.6 _n / Class E _n (ISO/IEC 11801 2010)
IP 67
PA UL 94 V0
Gold over nickel
5 mm / 10 mm
750
-40 °C...70 °C
AWG 26 / AWG 22
0.48 mm / 0.76 mm
AWG 24 / AWG 22
0.4 mm / 0.64 mm
IEC 61076-3-106 Var. 1, IEC 60603-7-51
CULUS; EAC
Note

Ordering data - Sets

RJ45 tool-free. AWG 26-22. TIA-A/B-PROFINET
RJ45 Crimp. AWG 27-24
Note

Type	Qty.	Order No.
IE-PS-V01P-RJ45-FH	10	1012490000
IE-PS-V01P-RJ45-TH	10	1012470000
Note		

Type	Qty.	Order No.
IE-PS-V01P-RJ45-FH-BP	10	1012570000
IE-PS-V01P-RJ45-TH-BP	10	1012560000
Note		

Ordering data - Empty housings

Note

Type	Qty.	Order No.
IE-PH-V01P	10	1012440000
Note		

Type	Qty.	Order No.
IE-PH-V01P-BP	10	1012460000
Note		

Accessories

Dust protection cap	Plug housing protective cap
	
Note	

Type	Qty.	Order No.
IE-PP-V01P	10	1965690000
Note		

Type	Qty.	Order No.
IE-PP-V01P	10	1965690000
Note		

Note

Plug inserts can also be ordered separately. Refer to Inserts.
--

Plug inserts can also be ordered separately. Refer to Inserts.
--

Flange bayonet V1 Plastic - RJ45

Module

Coupling

TIA-A

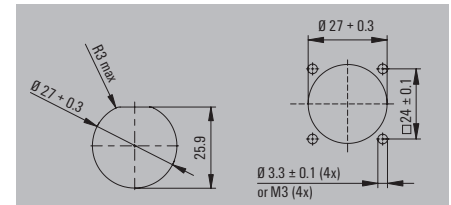
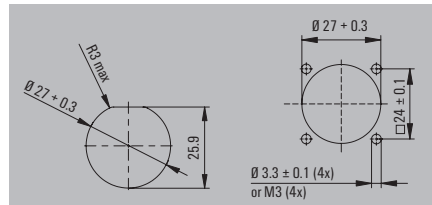

Technical data

Category	
Protection degree	IP 67
Housing main material	PA UL 94 V0
Contact surface	Gold over nickel
Plugging cycles	750
Ambient temperature (operational)	-40 °C...70 °C
Connector standard	IEC 61076-3-106 Var. 1, IEC 60603-7-51
Connection cross-section, flexible, min. / max.	AWG 26 / AWG 22
Connection diameter, flexible, min. / max.	0.48 mm / 0.76 mm
Connection cross-section, solid, min. / max.	AWG 24 / AWG 22
Connection diameter, solid, min. / max.	0.4 mm / 0.64 mm
Approvals	CULUS
Note	

Cat.6 _n / Class E _n (ISO/IEC 11801 2010)	
IP 67	
PA UL 94 V0	
Gold over nickel	
750	
-40 °C...70 °C	
IEC 61076-3-106 Var. 1, IEC 60603-7-51	
AWG 26 / AWG 22	
0.48 mm / 0.76 mm	
AWG 24 / AWG 22	
0.4 mm / 0.64 mm	
CULUS	
Note	

Cat.6 _n / Class E _n (ISO/IEC 11801 2010)	
IP 67	
PA UL 94 V0	
Gold over nickel	
750	
-40 °C...70 °C	
IEC 61076-3-106 Var. 1, IEC 60603-7-51	
CULUS	
Note	

Ordering data - Sets

Note	
------	--

Type	Qty.	Order No.
IE-BS-V01P-RJ45-FJ-A	10	1012380000

Type	Qty.	Order No.
IE-BS-V01P-RJ45-C	10	1012370000

Ordering data - Empty housings

Note	
------	--

Type	Qty.	Order No.
IE-BH-V01P	10	1016960000

Type	Qty.	Order No.
IE-BH-V01P	10	1016960000

Accessories

Dust protection cap	
 Flange-mounted housing protective cap	

Type	Qty.	Order No.
IE-BP-V01P	10	1965700000

Type	Qty.	Order No.
IE-BP-V01P	10	1965700000

Note

Plug inserts can also be ordered separately. Refer to Inserts.

Plug inserts can also be ordered separately. Refer to Inserts.

Bayonet V1 Plastic - RJ45

**Cable coupling bayonet V1
Plastic - RJ45**

Cable coupling

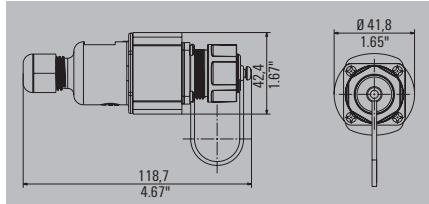
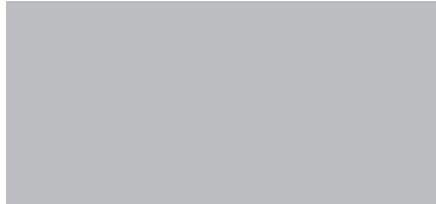

Technical data

Protection degree
Housing main material
Plugging cycles
Ambient temperature (operational)
Connector standard
Sheath diameter, min. / max.
Approvals
Note

IP 67
PA UL 94 V0
750
-40 °C...70 °C
IEC 61076-3-106 Var. 1
6 mm / 9.5 mm
Note

Ordering data

Variant 1	Cable coupling
Note	

Type	Qty.	Order No.
IE-CC-V01P	10	1061820000
RJ45 modules can be ordered separately		

Accessories

Inserts, Data
 RJ45 module EIA/TIA T568 B
RJ45 module PROFINET
RJ45 module EIA/TIA T568 A

Type	Qty.	Order No.
IE-BI-RJ45-FJ-B	10	1963840000
IE-BI-RJ45-FJ-P	10	1963830000
IE-BI-RJ45-FJ-A	10	1962850000

Note

Note

Plug PushPull V4 - RJ45

Without kink prevention

With kink prevention

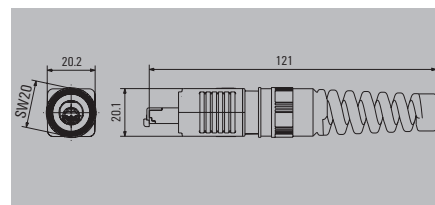
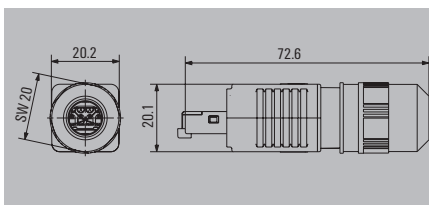

Technical data

Category
Protection degree
Housing main material
Contact surface
Sheath diameter, min. / max.
Plugging cycles
Ambient temperature (operational)
Connection cross-section, flexible, min. / max.
Connection diameter, flexible, min. / max.
Connection cross-section, solid, min. / max.
Connection diameter, solid, min. / max.
Connector standard
Approvals
Note

Cat.6 _n / Class E _x (ISO/IEC 11801 2010)
IP 67
PA UL 94 V0
Gold over nickel
5 mm / 10 mm
750
-40 °C...70 °C
AWG 27 / AWG 24
0.46 mm / 0.61 mm
AWG 24 / AWG 22
0.36 mm / 0.51 mm
IEC 61076-3-106 Var. 4, IEC 60603-7-51
CULUS; EAC

Cat.6 _n / Class E _x (ISO/IEC 11801 2010)
IP 67
PA UL 94 V0
Gold over nickel
5 mm / 10 mm
750
-40 °C...70 °C
AWG 27 / AWG 24
0.46 mm / 0.61 mm
AWG 24 / AWG 22
0.36 mm / 0.51 mm
IEC 61076-3-106 Var. 4, IEC 60603-7-51
CULUS; EAC

Ordering data - Sets

RJ45 tool-free. AWG 26-22. TIA-A/B-PROFINET
RJ45 tool-free. AWG 26-22. TIA-B
RJ45 Crimp. AWG 27-24
Note

Type	Qty.	Order No.
IE-PS-V04P-RJ45-FH	10	1963160000
IE-PS-V04P-RJ45-FH-B	10	1271240000
IE-PS-V04P-RJ45-TH	10	1963180000

Type	Qty.	Order No.
IE-PS-V04P-RJ45-FH-BP	10	1963170000
IE-PS-V04P-RJ45-TH-BP	10	1963190000

Ordering data - Empty housings

Note

Type	Qty.	Order No.
IE-PH-V04P	10	1962520000

Type	Qty.	Order No.
IE-PH-V04P-BP	10	1962530000

Accessories

Dust protection cap
Plug housing protective cap

Type	Qty.	Order No.
IE-PP-V04P	10	1963890000

Type	Qty.	Order No.
IE-PP-V04P	10	1963890000

Note

Plug inserts can also be ordered separately. Refer to Inserts.

Plug inserts can also be ordered separately. Refer to Inserts.

Flange PushPull V4 - RJ45

Module

Coupling

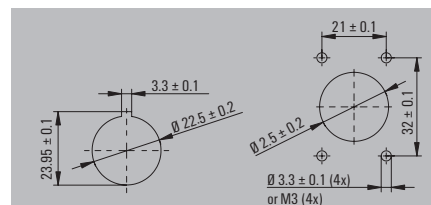
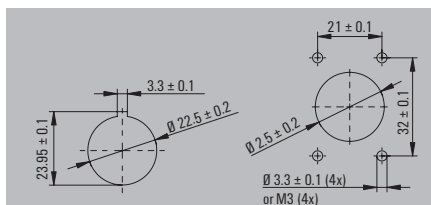

Technical data

Category
Protection degree
Housing main material
Contact surface
Plugging cycles
Ambient temperature (operational)
Connector standard
Connection cross-section, flexible, min. / max.
Connection diameter, flexible, min. / max.
Connection cross-section, solid, min. / max.
Connection diameter, solid, min. / max.
Approvals
Note

Cat.6 _n / Class E _n (ISO/IEC 11801 2010)
IP 67
PA UL 94 V0
Gold over nickel
750
-40 °C...70 °C
IEC 61076-3-106 Var. 4, IEC 60603-7-51
AWG 26 / AWG 22
0.48 mm
AWG 24 / AWG 22
0.4 mm / 0.64 mm
CULUS
Other approvals for individual parts of the set available

Cat.6 _n / Class E _n (ISO/IEC 11801 2010)
IP 67
PA UL 94 V0
Gold over nickel
750
-40 °C...70 °C
IEC 61076-3-106 Var. 4, IEC 60603-7-51
CULUS

Ordering data - Sets

RJ45 module TIA-A
RJ45 module TIA-B
Coupling
Note

Type	Qty.	Order No.
IE-BS-V04P-RJ45-FJ-A	10	1963500000
IE-BS-V04P-RJ45-FJ-B	10	1963730000

Type	Qty.	Order No.
IE-BS-V04P-RJ45-C	10	1963490000

Ordering data - Empty housings

Empty housing
Device flange
Note

Type	Qty.	Order No.
IE-BH-V04P	10	1963520000
IE-BHD-V04P	10	2027660000

Type	Qty.	Order No.
IE-BH-V04P	10	1963520000
IE-BHD-V04P	10	2027660000

Accessories

Dust protection cap
Flange-mounted housing protective cap

Note

Type	Qty.	Order No.
IE-BP-V04P	10	1963900000

Type	Qty.	Order No.
IE-BP-V04P	10	1963900000

Note

Plug inserts can also be ordered separately. Refer to Inserts.

Plug inserts can also be ordered separately. Refer to Inserts.

PushPull V4 - RJ45

Cable coupling PushPull V4 - RJ45

Cable coupling

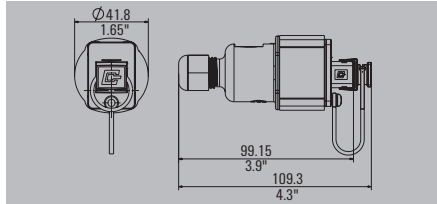
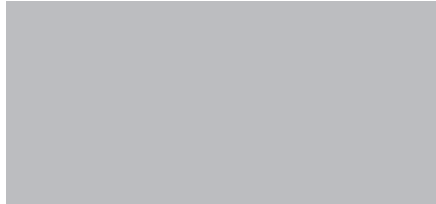

Technical data

Protection degree
Housing main material
Plugging cycles
Ambient temperature (operational)
Connector standard
Sheath diameter, min. / max.
Approvals
Note

IP 67
PA UL 94 V0
750
-40 °C...70 °C
IEC 61076-3-106 Var. 4
6 mm / 9.5 mm
Note

Ordering data

Cable coupling
Note

Type	Qty.	Order No.
IE-CC-V04P	10	1045960000
RJ45 modules can be ordered separately		

Accessories

Inserts, Data	
	RJ45 module EIA/TIA T568 B
	RJ45 module PROFINET
	RJ45 module EIA/TIA T568 A

Type	Qty.	Order No.
IE-BI-RJ45-FJ-B	10	1963840000
IE-BI-RJ45-FJ-P	10	1963830000
IE-BI-RJ45-FJ-A	10	1962850000

Note

Plug inserts can also be ordered separately. Refer to Inserts.

Flange-mounted empty housing / PushPull V4 device flange

- IP 67

Empty housing



Device flange

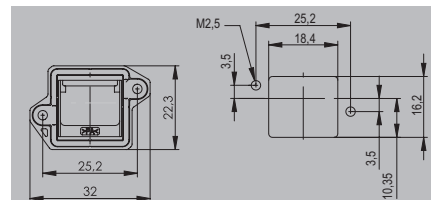
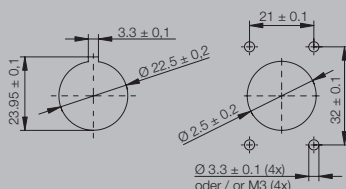

Technical data

Protection degree
Housing main material
Plugging cycles
Ambient temperature (operational)
Connector standard
Sheath diameter, min. / max.
Approvals

IP 67
PA UL 94 V0
750
-40 °C...70 °C
IEC 61076-3-106 Var. 4
5 mm / 10 mm
CULUS

IP 67
PA UL 94 V0
-40 °C...70 °C
IEC 61076-3-106 Var. 4

Note

Ordering data

Empty housing
Device flange

Type	Qty.	Order No.
IE-BH-V04P	10	1963520000

Type	Qty.	Order No.
IE-BHD-V04P	10	2027660000

Note

Accessories

Dust protection cap



Flange-mounted housing protective cap

Type	Qty.	Order No.
IE-BP-V04P	10	1963900000

Type	Qty.	Order No.
IE-BP-V04P	10	1963900000

Note

Plug inserts can also be ordered separately. Refer to Inserts.

PushPull V4 - F0

Plug PushPull V4 - fibre-optic-SC

Without kink prevention

With kink prevention

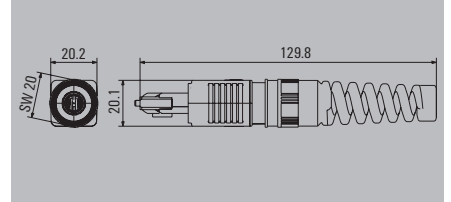
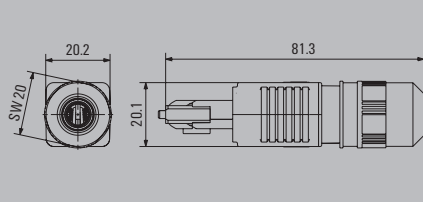

Technical data

Protection degree	IP 67
Housing main material	PA UL 94 V0
Sheath diameter, min. / max.	5 mm / 10 mm
Plugging cycles	500
Ambient temperature (operational)	-40 °C...70 °C
Connector standard	IEC 61076-3-106 Var. 4, IEC 61754-24
Insertion loss	0.5 dB singlemode; 0.4 dB multimode; 1.5 dB POF
Return loss (attenuation)	40 dB singlemode; 30 dB multimode
Approvals	EAC
Note	

Protection degree	IP 67
Housing main material	PA UL 94 V0
Sheath diameter, min. / max.	5 mm / 10 mm
Plugging cycles	500
Ambient temperature (operational)	-40 °C...70 °C
Connector standard	IEC 61076-3-106 Var. 4, IEC 61754-24
Insertion loss	0.5 dB singlemode; 0.4 dB multimode; 1.5 dB POF
Return loss (attenuation)	40 dB singlemode; 30 dB multimode
Approvals	EAC
Note	

Protection degree	IP 67
Housing main material	PA UL 94 V0
Sheath diameter, min. / max.	5 mm / 10 mm
Plugging cycles	500
Ambient temperature (operational)	-40 °C...70 °C
Connector standard	IEC 61076-3-106 Var. 4, IEC 61754-24
Insertion loss	0.5 dB singlemode; 0.4 dB multimode; 1.5 dB POF
Return loss (attenuation)	40 dB singlemode; 30 dB multimode
Approvals	EAC
Note	

Ordering data - Sets

	Singlemode
	Multimode
Note	

Type	Qty.	Order No.
IE-PS-V04P-2SC-SM	10	1963400000
IE-PS-V04P-2SC-MM	10	1963360000

Type	Qty.	Order No.
IE-PS-V04P-2SC-SM-BP	10	1963410000
IE-PS-V04P-2SC-MM-BP	10	1963370000



Ordering data - Empty housings

Note	
------	--

Type	Qty.	Order No.
IE-PH-V04P	10	1962520000

Type	Qty.	Order No.
IE-PH-V04P-BP	10	1962530000

Accessories

Tools	
	Fibre-optic tool case
	POF tool set
Dust protection cap	
	Plug housing protective cap

Type	Qty.	Order No.
IE-CTC-SCST-GOF	1	1032030000
TOOL SET IE-POF	1	1208930000
IE-PP-V04P	10	1963890000

Type	Qty.	Order No.
IE-CTC-SCST-GOF	1	1032030000
TOOL SET IE-POF	1	1208930000
IE-PP-V04P	10	1963890000

Note

Plug inserts can also be ordered separately. Refer to Inserts.

Plug inserts can also be ordered separately. Refer to Inserts.

Flange PushPull V4 - fibre-optic-SC

Standardised flange

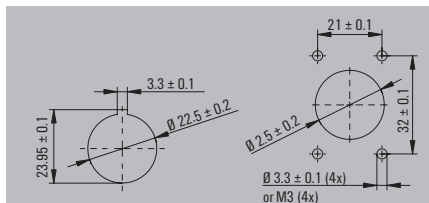

Technical data

Protection degree
Housing main material
Plugging cycles
Ambient temperature (operational)
Connector standard
Approvals
Note

IP 67
PA UL 94 V0
500
-40 °C...70 °C
IEC 61076-3-106 Var. 4, IEC 61754-4, IEC 61754-24
Note

Ordering data - Sets

Singlemode
Multimode
Note

Type	Qty.	Order No.
IE-BS-V04P-SCRJ2SC-SM-C	10	1963420000
IE-BS-V04P-SCRJ2SC-MM-C	10	1964470000
Note		

Ordering data - Empty housings

Empty housing
Note

Type	Qty.	Order No.
IE-BH-V04P	10	1963520000
Note		

Accessories

Dust protection cap
Flange-mounted housing protective cap

Note

Type	Qty.	Order No.
IE-BP-V04P	10	1963900000
Note		

Note

Plug inserts can also be ordered separately. Refer to Inserts.



PushPull V4 - F0

Plug PushPull V4 - fibre-optic-LC

Without kink prevention

With kink prevention

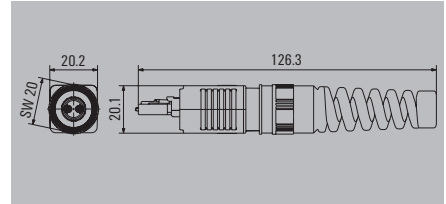
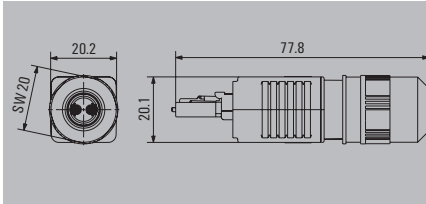

Technical data

Protection degree
Housing main material
Sheath diameter, min. / max.
Plugging cycles
Ambient temperature (operational)
Connector standard
Insertion loss
Return loss (attenuation)
Approvals
Note

IP 67
PA UL 94 V0
5 mm / 10 mm
500
-40 °C...70 °C
IEC 61076-3-106 Var. 4, IEC 61754-20
0.5 dB singlemode, 0.4 dB multimode
40 dB singlemode; 30 dB multimode
EAC

IP 67
PA UL 94 V0
5 mm / 10 mm
500
-40 °C...70 °C
IEC 61076-3-106 Var. 4, IEC 61754-20
0.5 dB singlemode, 0.4 dB multimode
40 dB singlemode; 30 dB multimode
EAC

Ordering data - Sets

	Singlemode
	Multimode
Note	

Type	Qty.	Order No.
IE-PS-V04P-2LC-SM	10	1963340000
IE-PS-V04P-2LC-MM	10	1963320000

Type	Qty.	Order No.
IE-PS-V04P-2LC-SM-BP	10	1963350000
IE-PS-V04P-2LC-MM-BP	10	1963330000

Ordering data - Empty housings

Note

Type	Qty.	Order No.
IE-PH-V04P	10	1962520000

Type	Qty.	Order No.
IE-PH-V04P-BP	10	1962530000

Accessories

Tools	Fibre-optic tool case Accessory set for LC plugs
Dust protection cap	Plug housing protective cap

Type	Qty.	Order No.
IE-CTC-SCST-GOF	1	1032030000
IE-CTC-AS-LC-GOF	1	1033350000
IE-PP-V04P	10	1963890000

Type	Qty.	Order No.
IE-CTC-SCST-GOF	1	1032030000
IE-CTC-AS-LC-GOF	1	1033350000
IE-PP-V04P	10	1963890000

Note

Plug inserts can also be ordered separately. Refer to Inserts.

Plug inserts can also be ordered separately. Refer to Inserts.

Flange PushPull V4 - fibre-optic-LC

Standardised flange

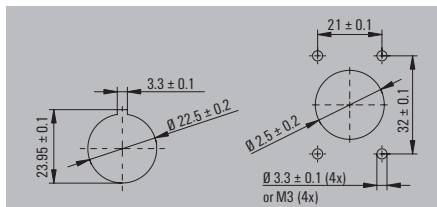

Technical data

Protection degree
Housing main material
Plugging cycles
Ambient temperature (operational)
Connector standard
Approvals
Note

IP 67
PA UL 94 V0
500
-40 °C...70 °C
IEC 61076-3-106 Var. 4, IEC 61754-20
Note

Ordering data - Sets

Singlemode
Multimode
Note

Type	Qty.	Order No.
IE-BS-V04P-LCD-SM-C	10	1963450000
IE-BS-V04P-LCD-MM-C	10	1964460000
Note		

Ordering data - Empty housings

Empty housing
Note

Type	Qty.	Order No.
IE-BH-V04P	10	1963520000
Note		

Accessories

Dust protection cap
Flange-mounted housing protective cap
Note



Type	Qty.	Order No.
IE-BP-V04P	10	1963900000
Note		

Note

Plug inserts can also be ordered separately. Refer to Inserts.

RockStar® V5 - RJ45

**RockStar® heavy-duty connector plug
V5 - RJ45**

Straight V5 - RJ45 plug

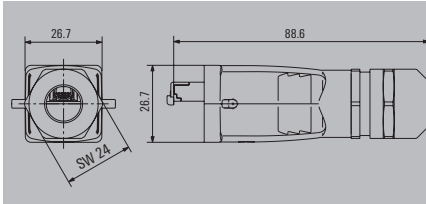

V5-RJ45 plug, angled

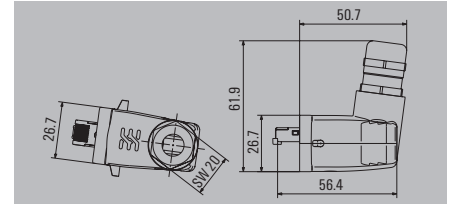

Technical data

Category
Protection degree
Housing main material
Contact surface
Sheath diameter, min. / max.
Plugging cycles
Ambient temperature (operational)
Connector standard
Approvals
Note

Cat.6 _n / Class E _n (ISO/IEC 11801 2010)
IP 67
diecast aluminium
Gold over nickel
5 mm / 12 mm
750
-40 °C...70 °C
IEC 61076-3-106 Var. 5, IEC 60603-7-51
CULUS; EAC

Cat.6 _n / Class E _n (ISO/IEC 11801 2010)
IP 67
diecast aluminium
Gold over nickel
5 mm / 10 mm
750
-40 °C...70 °C
IEC 61076-3-106 Var. 5, IEC 60603-7-51
EAC
Other approvals for individual parts of the set available

Ordering data - Sets

RJ45 tool-free. AWG 26-22. TIA-A/B-PROFINET
RJ45 tool-free. AWG 26-22 . TIA-B
RJ45 Crimp. AWG 27-24
Note

Type	Qty.	Order No.
IE-PS-V05M-RJ45-FH	10	1963200000
IE-PS-V05M-RJ45-FH-B	10	1271250000
IE-PS-V05M-RJ45-TH	10	1963110000

Type	Qty.	Order No.
IE-PS-V05M-A-RJ45-FH	10	1077300000

Ordering data - Empty housings

Note

Type	Qty.	Order No.
IE-PH-V05M	10	1962540000

Type	Qty.	Order No.

Accessories

Dust protection cap	Plug housing protective cap
	Spare insert holder

Type	Qty.	Order No.
IE-PP-V05M	1	1968920000
IE-PH-AD-V05M-RJ45	1	1993540000

Type	Qty.	Order No.
IE-PP-V05M	1	1968920000

Note

Plug inserts can also be ordered separately. Refer to Inserts.

Plug inserts can also be ordered separately. Refer to Inserts.

RockStar® heavy-duty connector flange
V5 - RJ45

Module

Coupling

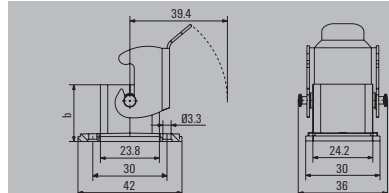
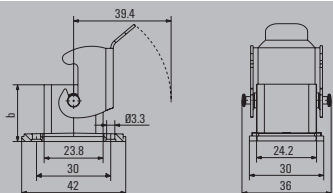

Technical data

Protection degree
Housing main material
Contact surface
Plugging cycles
Ambient temperature (operational)
Connector standard
Connection cross-section, flexible, min. / max.
Connection diameter, flexible, min. / max.
Connection cross-section, solid, min. / max.
Connection diameter, solid, min. / max.
Approvals
Note

IP 67
diecast aluminium
Gold over nickel
750
-40 °C...70 °C
IEC 61076-3-106 Var. 5, IEC 60603-7-51
AWG 26 / AWG 22
0.48 mm / 0.76 mm
AWG 24 / AWG 22
0.4 mm / 0.64 mm
CULUS
Note

IP 67
diecast aluminium
Gold over nickel
750
-40 °C...70 °C
IEC 61076-3-106 Var. 5, IEC 60603-7-51
CULUS
Note

Ordering data - Sets

TIA-A Cat. 6 _A
PROFINET Cat. 5
Coupling
Note

Type	Qty.	Order No.
IE-BS-V05M-RJ45-FJ-A	10	1963460000
IE-BS-V05M-RJ45-FJ-P	10	1963700000
Note		

Type	Qty.	Order No.
IE-BS-V05M-RJ45-C	10	1963510000
Note		

Ordering data - Empty housings

Note

Type	Qty.	Order No.
IE-BH-V05M	10	1963530000
Note		

Type	Qty.	Order No.
IE-BH-V05M	10	1963530000
Note		

Accessories

Dust protection cap	Flange-mounted housing protective cap
	
Note	

Type	Qty.	Order No.
IE-BP-V05M	10	1968930000
Note		

Type	Qty.	Order No.
IE-BP-V05M	10	1968930000
Note		

Note

Plug inserts can also be ordered separately. Refer to Inserts.

Plug inserts can also be ordered separately. Refer to Inserts.

SnapIn V6 - RJ45

Plug SnapIn V6 - RJ45

- Cat. 6
- IP 67

Without kink prevention

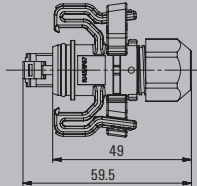

Technical data

Category	Cat.6 (ISO/IEC 11801)
Protection degree	IP 67
Shielding	360° shield contact
Housing main material	PA 66, UL 94: V-0
Contact surface	Gold over nickel
Colour	Light Grey
Plugging cycles	750
Wiring	EIA/TIA T568 A
Type of mounting	Floor-mounted, for exposed connections, Wall mounting
Ambient temperature (operational)	-40 °C...70 °C
Connector standard	IEC 61076-3-106 Var. 6, IEC 60603-7-5
Approvals	EAC; GERMLLOYD

Category	Cat.6 (ISO/IEC 11801)
Protection degree	IP 67
Shielding	360° shield contact
Housing main material	PA 66, UL 94: V-0
Contact surface	Gold over nickel
Colour	Light Grey
Plugging cycles	750
Wiring	EIA/TIA T568 A
Type of mounting	Floor-mounted, for exposed connections, Wall mounting
Ambient temperature (operational)	-40 °C...70 °C
Connector standard	IEC 61076-3-106 Var. 6, IEC 60603-7-5
Approvals	EAC; GERMLLOYD

Note

Ordering data

Note

Accessories

Insert

Type	Qty.	Order No.
IE-P-IP67	1	8808380000

Type	Qty.	Order No.
IE-PM-RJ45-TH	100	1963580000

Note

See also the „Accessories“ chapter.

Flange SnapIn V6 - RJ45

- Cat. 6
- IP 67

Module

Coupling

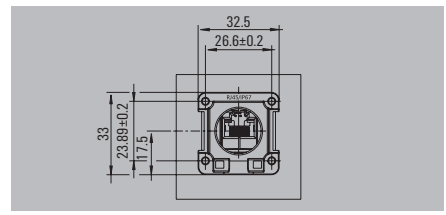
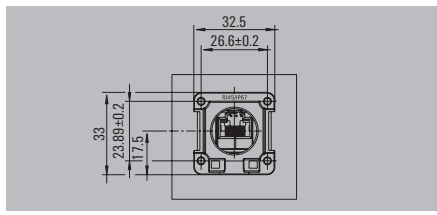

Technical data

Category	
Protection degree	IP 67
Shielding	360° shield contact
Housing main material	PA 66, UL 94: V-0
Contact surface	Gold over nickel
Colour	Light Grey
Plugging cycles	750
Type of mounting	Cabinet, Distribution box
Wiring	Colour-coded pin assignment according to EIA/TIA T568 A., EIA/TIA T568 B
Ambient temperature (operational)	-40 °C...70 °C
Connector standard	IEC 61076-3-106 Var. 6, IEC 60603-7-5
Approvals	EAC; GERMILLOYD
Note	

Category	Cat.6 (ISO/IEC 11801)
Protection degree	IP 67
Shielding	360° shield contact
Housing main material	PA 66, UL 94: V-0
Contact surface	Gold over nickel
Colour	Light Grey
Plugging cycles	750
Type of mounting	Cabinet, Distribution box
Wiring	Colour-coded pin assignment according to EIA/TIA T568 A., EIA/TIA T568 B
Ambient temperature (operational)	-40 °C...70 °C
Connector standard	IEC 61076-3-106 Var. 6, IEC 60603-7-5
Approvals	EAC; GERMILLOYD
Note	

Category	Cat.6 (ISO/IEC 11801)
Protection degree	IP 67
Shielding	360° shield contact
Housing main material	PA 66, UL 94: V-0
Contact surface	Gold over nickel
Colour	Light Grey
Plugging cycles	750
Type of mounting	Cabinet, Distribution box
Wiring	Colour-coded pin assignment according to EIA/TIA T568 A., EIA/TIA T568 B
Ambient temperature (operational)	-40 °C...70 °C
Connector standard	IEC 61076-3-106 Var. 6, IEC 60603-7-5
Approvals	EAC; GERMILLOYD
Note	

Ordering data

	Straight	
	Angled, upwards	
	Angled, downwards	
Note		

Type	Qty.	Order No.
IE-XM-RJ45/IDC-IP67	1	8808440000

Type	Qty.	Order No.
IE-XM-RJ45/RJ45-IP67	1	8808450000
IE-XM-6U-RJ45/RJ45-IP67	1	8829440000
IE-XM-6D-RJ45/RJ45-IP67	1	8829450000

Accessories

Flange insert
RJ45 module A, straight
RJ45 coupling, straight

Type	Qty.	Order No.
IE-XR-RJ45/IDC	1	8808330000

Type	Qty.	Order No.
IE-XR-RJ45/RJ45-2	24	8952950000

Note

Note

Note

SnapIn V6 - RJ45

Cable coupling SnapIn V6 - RJ45

- Cat. 6
- IP 67

Cable coupling

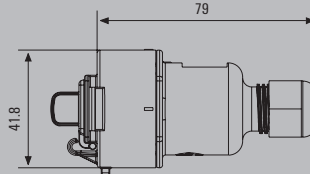

Technical data

Category	Cat.6 (ISO/IEC 11801)
Protection degree	IP 67
Shielding	360° shield contact
Housing main material	PA 66, UL 94: V-0
Contact surface	Gold over nickel
Colour	Light Grey
Plugging cycles	750
Type of mounting	Floor-mounted, for exposed connections, Wall mounting
Wiring	Colour-coded pin assignment according to EIA/TIA T568 A., EIA/TIA T568 B
Ambient temperature (operational)	-40 °C...70 °C
Connector standard	IEC 61076-3-106 Var. 6, IEC 60603-7-5
Sheath diameter, min. / max.	6 mm / 9.5 mm
Approvals	EAC; GERMILLOYD

Note

Ordering data

Type	Qty.	Order No.
IE-C-IP67	1	8813090000

Note

Accessories

Type	Qty.	Order No.
------	------	-----------

Note

See also the „Accessories“ chapter.

M12 D-coded

**M12 plug,
Tension-clamp connection,
D-coded**

SAISM / SAIBM

SAISW / SAIBW

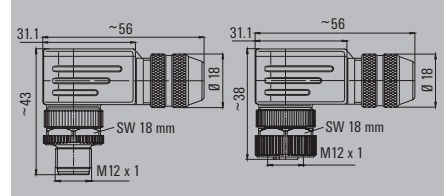
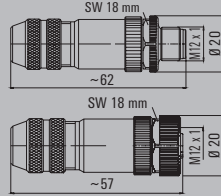

Technical data

Type of connection	Tension clamp connection
Housing main material	PA
Ambient temperature (operational)	-40 °C...85 °C
Connector standard	IEC 61076-2-101
connection thread	M12
Cable diameter	6...8 mm (PG9)
Conductor cross-section min. / max.	0.25 mm ² / 0.5 mm ²
Rated current	4
Rated voltage	250
Temperature range of housing	-25...+85 °C
Protection degree	IP 67
Contact surface	Gold-plated

Type of connection	Tension clamp connection
Housing main material	PA
Ambient temperature (operational)	-40 °C...85 °C
Connector standard	IEC 61076-2-101
connection thread	M12
Cable diameter	6...8 mm (PG9)
Conductor cross-section min. / max.	0.25 mm ² / 0.5 mm ²
Rated current	4
Rated voltage	250
Temperature range of housing	-25...+85 °C
Protection degree	IP 67
Contact surface	Gold-plated

Type of connection	Tension clamp connection
Housing main material	PA
Ambient temperature (operational)	-40 °C...85 °C
Connector standard	IEC 61076-2-101
connection thread	M12
Cable diameter	6...8 mm (PG9)
Conductor cross-section min. / max.	0.25 mm ² / 0.5 mm ²
Rated current	4
Rated voltage	250
Temperature range of housing	-25...+85 °C
Protection degree	IP 67
Contact surface	Gold-plated

Note

Ordering data

Male	4-pole, PG 9
Female	4-pole, PG 9
Note	

Type	Qty.	Order No.
SAISM-4/8S-M12 4P D-ZF	1	1892120001
SAIBM-4/8S-M12 4P D-ZF	1	1892130001

Type	Qty.	Order No.
SAISW-4/8S-M12 4P D-ZF	1	1803930001
SAIBW-4/8S-M12 4P D-ZF	1	1139330000

Accessories

Type	Qty.	Order No.

Type	Qty.	Order No.

Note

M12 plug,
Screw connection,
D-coded

SAISM / SAIBM



Industrial Ethernet

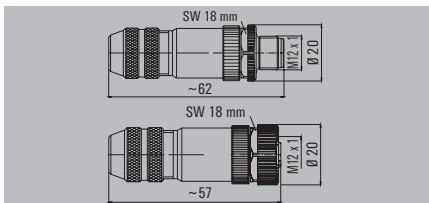

Technical data

Type of connection	Screw connection
Housing main material	CuZn
Ambient temperature (operational)	-40 °C...85 °C
Connector standard	IEC 61076-2-101
connection thread	M12
Cable diameter	6..8 mm (PG9)
Conductor cross-section min. / max.	0.25 mm ² / 0.75 mm ²
Rated current	4
Rated voltage	250
Temperature range of housing	-25...+85 °C
Protection degree	IP 67
Contact surface	Gold-plated
Note	

Ordering data

Male	4-pole, PG 9	Type	Qty.	Order No.
		SAISM-4/8S-M12-4P D-COD	1	1892120000
Female	4-pole, PG 9	Type	Qty.	Order No.
		SAIBM-4/8S-M12-4P D-COD	1	1892130000
Note				

Accessories

Type	Qty.	Order No.

Note

Note

M12 D-coded

Adapter / coupling M12

- Cat. 5
- IP 67
- D-coded

Adapter M12-RJ45, female



Adapter M12-RJ45, male

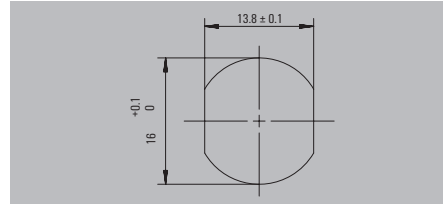
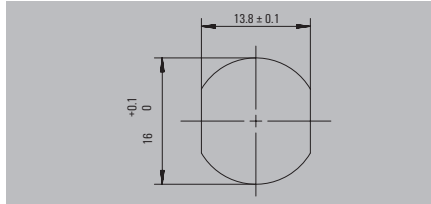
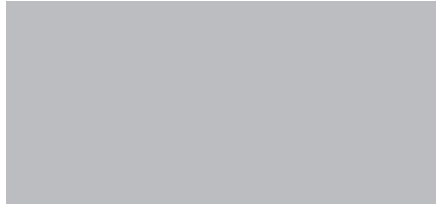

Technical data

Category	
Protection degree	
Housing main material	
Shielding	
Ambient temperature (operational)	
Connector standard	
Approvals	
Note	

Cat.5 (ISO/IEC 11801)
IP 65
PA 66
Yes
-25 °C...80 °C
IEC 60603-7-5, IEC 61076-2-101
EAC

Cat.5 (ISO/IEC 11801)
IP 65
PA 66
Yes
-25 °C...80 °C
IEC 60603-7-5, IEC 61076-2-101
EAC

Ordering data

Adaptor	
	Straight
	Angled
Coupling	
Note	

Type	Qty.	Order No.
IE-M12-ADAP S	1	8901620000
IE-M12-ADAP A	1	8901630000

Type	Qty.	Order No.
IE-AD-M12DRJ45-MF-180	1	1514970000
IE-AD-M12DRJ45-MF-90	1	1514940000

Accessories

Type	Qty.	Order No.
------	------	-----------

Type	Qty.	Order No.
------	------	-----------

Type	Qty.	Order No.
------	------	-----------

Note

--

--

Adapter / coupling M12

- Cat. 5
- IP 67
- D-coded

Coupling M12-M12



Technical data

Category
Protection degree
Housing main material
Shielding
Ambient temperature (operational)
Connector standard
Approvals
Note

Cat.5 (ISO/IEC 11801)
IP 67
Polyamide, Brass, nickel-plated
360° shield contact
-5 °C...60 °C
IEC 61076-2-101
EAC
Note

Ordering data

Adaptor
Straight Angled
Coupling
Note

Type	Qty.	Order No.
IE-M12-COUP	1	8901640000
Note		

Accessories

Note

Type	Qty.	Order No.
Note		

Note

Note

M12 D-coded

M12 PCB connection element

- Cat. 5
- For installation into the end device
- D-coded

Standard assembly



Additional fastening mechanism



Technical data

Category
 Protection degree
 Configuration
 Housing main material
 Shielding
 Ambient temperature (operational)
 Connector standard
 Approvals

Cat.5 (ISO/IEC 11801)
 IP 65 according to DIN EN 60529
 Reflow compatible
 CuZn, Polyamide, nickel-plated
 360° shield contact
 -25...85 °C
 IEC 61076-2-101
 EAC

Cat.5 (ISO/IEC 11801)
 IP 65 according to DIN EN 60529
 Reflow compatible
 CuZn, Polyamide, nickel-plated
 360° shield contact
 -25...85 °C
 IEC 61076-2-101
 EAC

Note

Ordering data

Connection element	
	Straight
	Angled

Type	Qty.	Order No.
IE-M12-PCBCE	60	8902810000

Type	Qty.	Order No.
IE-M12-PCBCE-PANEL	10	8902820000
IE-M12-PCBCE-PANEL-A	10	1393470000

Note

Accessories

Type	Qty.	Order No.

Type	Qty.	Order No.

Note

M12 plug
M12 X-type Cat. 6_A

Plug, AWG 26-22

Plug, AWG 27-22

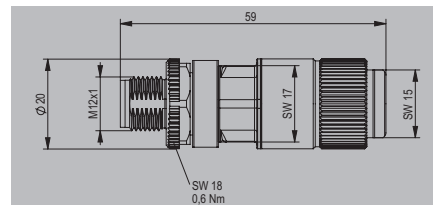
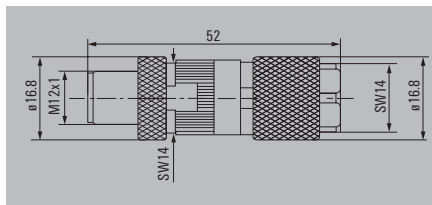
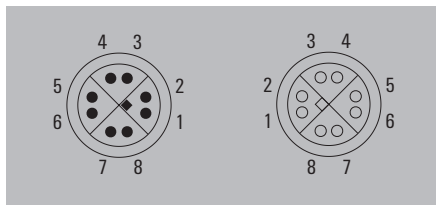

Technical data

Category	Cat.6 _A / Class E _x (ISO/IEC 11801 2010)
Protection degree	IP 67
Connection 1 / 2	M12 / Insulation displacement technology
Housing main material	Zinc diecast
connection thread	M12
Contact material / Contact surface	Brass / Gold-plated
Ambient temperature (operational)	-25 °C...85 °C
Connector standard	IEC 61076-2-109
Current-carrying capacity at 50 °C	0.5 A @ 40 °C
Rated voltage	48 V
Insulation resistance	100 MΩ
Plugging cycles	≥ 100
Configuration	
Wall thickness, min. / max.	
Shielding	360° all-round enclosure
Connection diameter, flexible, min. / max.	0.48 mm / 0.76 mm
Connection cross-section, flexible, min. / max.	AWG 26 / AWG 22
Connection diameter, solid, min. / max.	0.4 mm / 0.64 mm
Connection cross-section, solid, min. / max.	AWG 24 / AWG 22
Insulation cross-section, max.	1.6 mm
Sheath diameter min. / max.	5 mm / 9.7 mm
Approvals	CULUS; EAC
Note	

Category	Cat.6 _A / Class E _x (ISO/IEC 11801 2010)
Protection degree	IP 67
Connection 1 / 2	M12 / Insulation displacement technology
Housing main material	Zinc diecast
connection thread	M12
Contact material / Contact surface	Brass, tinned / Gold-plated
Ambient temperature (operational)	-40 °C...85 °C
Connector standard	IEC 61076-2-109
Current-carrying capacity at 50 °C	0.5 A @ 40 °C
Rated voltage	50 V
Insulation resistance	100 MΩ
Plugging cycles	≥ 100
Configuration	
Wall thickness, min. / max.	
Shielding	360° all-round enclosure
Connection diameter, flexible, min. / max.	0.46 mm / 0.76 mm
Connection cross-section, flexible, min. / max.	AWG 27 / AWG 22
Connection diameter, solid, min. / max.	0.51 mm / 0.64 mm
Connection cross-section, solid, min. / max.	AWG 24 / AWG 22
Insulation cross-section, max.	1.6 mm
Sheath diameter min. / max.	5.5 mm / 9 mm
Approvals	CULUS
Note	

Ordering data

	Plugs
	90° adapter
	180° adapter
Note	

Type	Qty.	Order No.
IE-PS-M12X-P-FH	10	1324020000

Type	Qty.	Order No.
IE-PS-M12X-P-AWG22/27FH	1	2007500000

Accessories

Type	Qty.	Order No.

Type	Qty.	Order No.

Type	Qty.	Order No.

Note

--

--

M12 X-Type

M12 plug M12 X-type Cat. 6_A

Plug, female

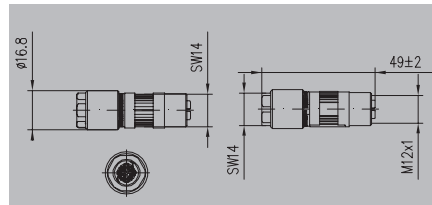

Flange

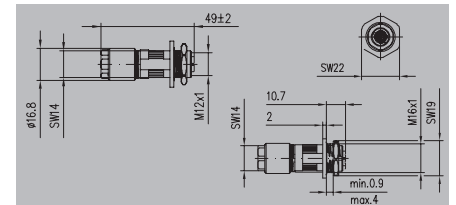

Technical data

Category	Cat.6 _A / Class E _A (ISO/IEC 11801 2010)
Protection degree	IP 67
Connection 1 / 2	M12 / Insulation displacement technology
Housing main material	Zinc diecast
connection thread	M12
Contact material / Contact surface	Brass / Gold-plated
Ambient temperature (operational)	-40 °C...85 °C
Connector standard	IEC 61076-2-109
Current-carrying capacity at 50 °C	0.5 A @ 40 °C
Rated voltage	48 V
Insulation resistance	100 MΩ
Plugging cycles	≥ 100
Configuration	
Wall thickness, min. / max.	
Shielding	360° all-round enclosure
Connection diameter, flexible, min. / max.	0.48 mm / 0.76 mm
Connection cross-section, flexible, min. / max.	AWG 26 / AWG 22
Connection diameter, solid, min. / max.	0.4 mm / 0.64 mm
Connection cross-section, solid, min. / max.	AWG 24 / AWG 22
Insulation cross-section, max.	1.6 mm
Sheath diameter min. / max.	5 mm / 9.7 mm
Approvals	
Note	

Category	Cat.6 _A / Class E _A (ISO/IEC 11801 2010)
Protection degree	IP 67
Connection 1 / 2	M12 / Insulation displacement technology
Housing main material	Zinc diecast
connection thread	M12
Contact material / Contact surface	Brass / Gold-plated
Ambient temperature (operational)	-40 °C...85 °C
Connector standard	IEC 61076-2-109
Current-carrying capacity at 50 °C	0.5 A @ 40 °C
Rated voltage	48 V
Insulation resistance	100 MΩ
Plugging cycles	≥ 100
Configuration	
Wall thickness, min. / max.	
Shielding	360° all-round enclosure
Connection diameter, flexible, min. / max.	0.48 mm / 0.76 mm
Connection cross-section, flexible, min. / max.	AWG 26 / AWG 22
Connection diameter, solid, min. / max.	0.4 mm / 0.64 mm
Connection cross-section, solid, min. / max.	AWG 24 / AWG 22
Insulation cross-section, max.	1.6 mm
Sheath diameter min. / max.	5 mm / 9.7 mm
Approvals	
Note	

Category	Cat.6 _A / Class E _A (ISO/IEC 11801 2010)
Protection degree	IP 67
Connection 1 / 2	M12 / Insulation displacement technology
Housing main material	Zinc diecast
connection thread	M12
Contact material / Contact surface	CuZn / Gold-plated
Ambient temperature (operational)	-40 °C...85 °C
Connector standard	IEC 61076-2-109
Current-carrying capacity at 50 °C	0.5 A @ 40 °C
Rated voltage	48 V
Insulation resistance	100 MΩ
Plugging cycles	≥ 100
Configuration	
Wall thickness, min. / max.	0.9 mm / 4 mm
Shielding	360° all-round enclosure
Connection diameter, flexible, min. / max.	0.48 mm / 0.76 mm
Connection cross-section, flexible, min. / max.	AWG 26 / AWG 22
Connection diameter, solid, min. / max.	0.4 mm / 0.64 mm
Connection cross-section, solid, min. / max.	AWG 24 / AWG 22
Insulation cross-section, max.	1.6 mm
Sheath diameter min. / max.	5 mm / 9.7 mm
Approvals	
Note	

Ordering data

	Plugs
	90° adapter
	180° adapter
Note	

Type	Qty.	Order No.
IE-PS-M12X-S-FH	1	1516330000

Type	Qty.	Order No.
IE-BS-M12X-S-FH	1	1516340000

Accessories

Mounting tool
Tool set
Tool set with torque function

Screwty
Cable gland tool, M 12
Cable gland tool with torque function, M 12

Type	Qty.	Order No.
Screwty Set	1	1910000000
Screwty Set -DM	1	1920000000
Screwty-M12 F	1	1900020000
Screwty-M12 F-DM	1	1900021000

Type	Qty.	Order No.
Screwty Set	1	1910000000
Screwty Set -DM	1	1920000000
Screwty-M12 F	1	1900020000
Screwty-M12 F-DM	1	1900021000

Note

--

--

M12 plug
M12 X-type Cat. 6_A

Adapter M12 X-Type-RJ45

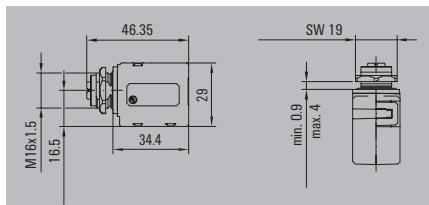
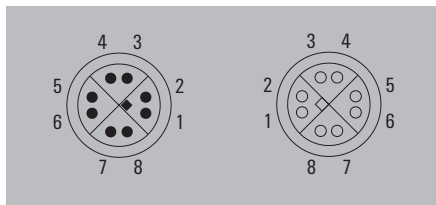

Technical data

Category	Cat.6 _A / Class E _A (ISO/IEC 11801 2010)
Protection degree	IP 67
Connection 1 / 2	RJ45 / M12
Housing main material	Zinc diecast
connection thread	M12
Contact material / Contact surface	CuZn / Gold over nickel
Ambient temperature (operational)	-25 °C...85 °C
Connector standard	IEC 61076-2-109, IEC 60603-7-51
Current-carrying capacity at 50 °C	0.5 A @ 40 °C
Rated voltage	60 V
Insulation resistance	100 MΩ
Plugging cycles	≥ 100 (M12), 750 (RJ45)
Configuration	M12 socket to RJ45 socket
Wall thickness, min. / max.	0.9 mm / 4 mm
Shielding	360° shield contact
Connection diameter, flexible, min. / max.	
Connection cross-section, flexible, min. / max.	
Connection diameter, solid, min. / max.	
Connection cross-section, solid, min. / max.	
Insulation cross-section, max.	
Sheath diameter min. / max.	
Approvals	CULUS; EAC
Note	

Type	Qty.	Order No.
IE-AD-M12XRJ45-90	1	1400610000
IE-AD-M12XRJ45-180	1	1400620000
Note		

Ordering data

Plugs	
90° adapter	
180° adapter	
Note	

Type	Qty.	Order No.
Note		

Accessories

Type	Qty.	Order No.
Note		

Type	Qty.	Order No.
Note		

Note

Note

M12 X-Type

PCB socket
M12 X-type Cat. 6_A

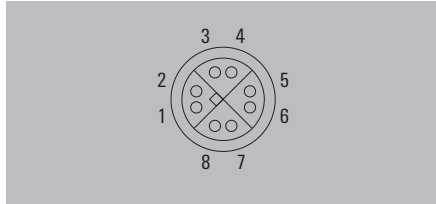

Technical data

Category
Protection degree
Connection 1 / 2
Housing main material
connection thread
Contact material / Contact surface
Ambient temperature (operational)
Connector standard
Current-carrying capacity at 50 °C
Rated voltage
Insulation resistance
Plugging cycles
Configuration
Wall thickness, min. / max.
Shielding
Approvals
Note

Ordering data

	pre-assembled
	1-piece design
	2-piece design
Note	

Accessories

Type	Qty.	Order No.

Note

PCB socket

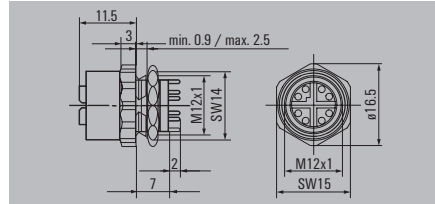

Cat.6 _A / Class E _A (ISO/IEC 11801 2010)
IP 67 (when screwed in)
M12 / Solder connection
CuZn
M12
CuZn / Gold over nickel
-40 °C...85 °C
IEC 61076-2-109
0.5 A @ 40 °C
48 V
100 MΩ
≥ 100
Reflow compatible
0.9 mm / 2.5 mm
360° all-round enclosure
CULUS; EAC
Note

Type	Qty.	Order No.
IE-PCB-M12X-S-180	10	1324010000
IE-PCB2-M12X-S-180	10	1393080000
Note		

Type	Qty.	Order No.

Note

PCB socket, back panel mounting

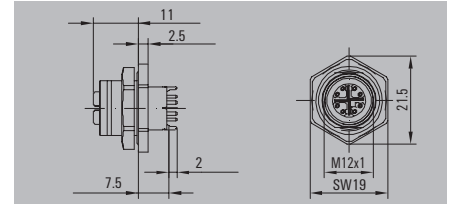

Cat.6 _A / Class E _A (ISO/IEC 11801 2010)
IP 67 (when screwed in)
M12 / Solder connection
CuZn
M12
CuZn / Gold over nickel
-40 °C...85 °C
IEC 61076-2-109
0.5 A @ 40 °C
48 V
100 MΩ
≥ 100
Reflow compatible, Back panel mounting
0.9 mm / 2.5 mm
360° all-round enclosure
CULUS; EAC
Note

Type	Qty.	Order No.
IE-PCBR-M12X-S-180	10	1427670000
IE-PCBR2-M12X-S-180	10	1444650000
Note		

Type	Qty.	Order No.

Note

PCB socket
M12 X-type Cat. 6_A

PCB socket, angled

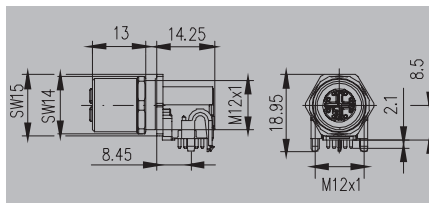

Technical data

Category	
Protection degree	
Connection 1 / 2	
Housing main material	
connection thread	
Contact material / Contact surface	
Ambient temperature (operational)	
Connector standard	
Current-carrying capacity at 50 °C	
Rated voltage	
Insulation resistance	
Plugging cycles	
Configuration	
Wall thickness, min. / max.	
Shielding	
Approvals	
Note	

Cat.6 _A / Class E _A (ISO/IEC 11801 2010)
IP 67 (when screwed in)
M12 / Solder connection
CuZn
M12
CuZn / Gold over nickel
-40 °C...85 °C
IEC 61076-2-109
0.5 A @ 40 °C
48 V
100 MΩ
≥ 100
Reflow compatible
1 mm / 2.5 mm
360° all-round enclosure

Ordering data

	pre-assembled
	1-piece design
	2-piece design
Note	

Type	Qty.	Order No.
IE-PCB-M12X-S-90	10	2168220000

Accessories

--

Type	Qty.	Order No.

Note

--



Inserts

RJ45 plug inserts, tool-free

- Cat. 6_A
- IP 20
- For housing variants 1, 4, 5 and 14

8-wire



4-wire

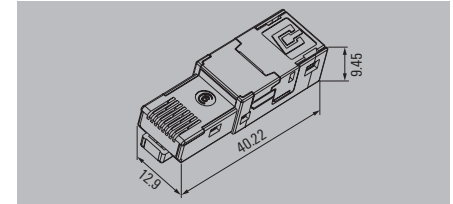
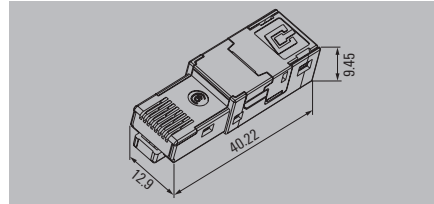
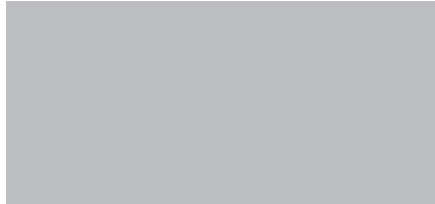

Technical data

Category
Protection degree
Plugging cycles
Shielding
Housing main material
Contact material
Contact surface
Connection cross-section, flexible, min. / max.
Connection diameter, flexible, min. / max.
Connection cross-section, solid, min. / max.
Connection diameter, solid, min. / max.
Wire connection cross-section, finely stranded
Insulation diameter, min. / max.
Humidity
Ambient temperature (operational)
Insulation resistance
Contact resistance
Dielectric strength, contact / contact
Dielectric strength, contact / shield
Current-carrying capacity at 50 °C
PoE / PoE+
Speed
Connector standard
Approvals
Note

Cat.6 _x / Class E _x (ISO/IEC 11801 2010)
IP 67 with housing
750
360° all-round enclosure
Zinc diecast
Gold over nickel, Au ≥ 0.8 μm
AWG 26 / AWG 22
0.48 mm / 0.76 mm
AWG 24 / AWG 22
0.4 mm / 0.64 mm
Approval of the cable by Weidmüller necessary
0.85 mm...1.6 mm
-40 °C...70 °C
500 MΩ
≤ 20 mΩ
≥ 1000 V DC
≥ 1500 V DC
1 A
conforming to IEEE 802.3at
10 GBit/s
IEC 60603-7-51
CULUS; EAC
Approvals available on request

Cat.5 (ISO/IEC 11801)
IP 67 with housing
750
360° all-round enclosure
Zinc diecast
Gold over nickel, Au ≥ 0.8 μm
AWG 26 / AWG 22
AWG 24 / AWG 22
0.4 mm / 0.64 mm
Approval of the cable by Weidmüller necessary
0.85 mm...1.6 mm
-40 °C...70 °C
500 MΩ
≤ 20 mΩ
≥ 1000 V DC
≥ 1500 V DC
1 A
conforming to IEEE 802.3at
100 MBit/s
IEC 60603-7-51
CULUS; EAC

Ordering data

tool-free	TIA-A/B/PROFINET
	TIA-A
	TIA-B
	PROFINET
Note	

Type	Qty.	Order No.
IE-PI-RJ45-FH	10	1962730000
IE-PI-RJ45-FH-A	10	1132010000
IE-PI-RJ45-FH-B	10	1132020000

Type	Qty.	Order No.
IE-PI-RJ45-FH-P	10	1132030000

Accessories

Tools	Optional pressing tool
	

Type	Qty.	Order No.
PWZ RJ45	1	1118040000

Type	Qty.	Order No.
PWZ RJ45	1	1118040000

Note

Note

Note

RJ45 plug inserts, crimp

- Cat. 6_A
- IP 20
- For housing variants 1, 4, 5 and 14

8-wire

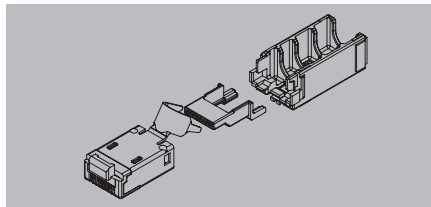

Technical data

Category	
Protection degree	
Plugging cycles	
Shielding	
Housing main material	
Contact material	
Contact surface	
Connection cross-section, flexible, min. / max.	
Connection diameter, flexible, min. / max.	
Connection cross-section, solid, min. / max.	
Connection diameter, solid, min. / max.	
Insulation diameter, min. / max.	
Humidity	
Ambient temperature (operational)	
Insulation resistance	
Contact resistance	
Dielectric strength, contact / contact	
Dielectric strength, contact / shield	
Current-carrying capacity at 50 °C	
PoE / PoE+	
Speed	
Connector standard	
Approvals	
Note	

Cat.6 _A / Class E _A (ISO/IEC 11801 2010)
IP 67 with housing
750
360° all-round enclosure
Brass, PC UL 94 V0
Phosphorus bronze
Gold over nickel, Au ≥ 0.8 µm, Ni 2.54 µm
AWG 27 / AWG 24
0.46 mm / 0.61 mm
AWG 24 / AWG 24
0.4 mm / 0.51 mm
0.85 mm...1.05 mm
0...93 % rel. humidity
-40 °C...70 °C
500 MΩ
≤ 20 mΩ
≥ 1000 V DC
≥ 1500 V DC
1 A
conforming to IEEE 802.3af
IEC 60603-7-51
CURUS; EAC

Ordering data

Crimp
Note

Type	Qty.	Order No.
IE-PI-RJ45-TH	10	1962720000

Accessories

Tools
 Crimping tool

Type	Qty.	Order No.
TT 8 RS MP 8	1	9202800000

Note

--

Inserts

RJ45 flange inserts, module

- Cat. 6_A
- IP 20
- For housing variants 1, 4, 5, 14 and for FrontCom®

8-wire

4-wire

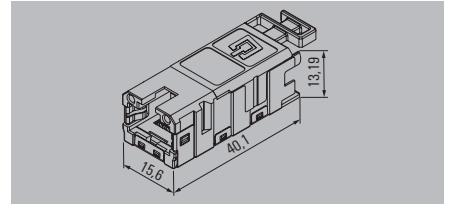
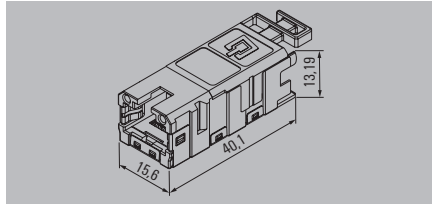
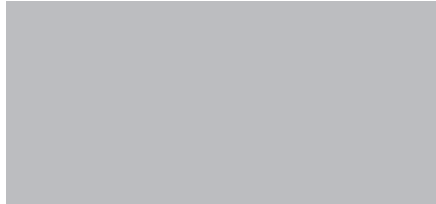
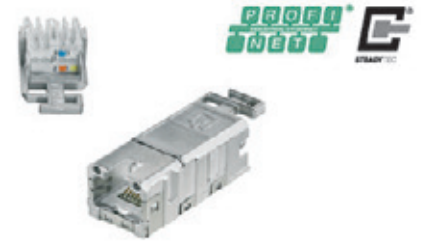

Technical data

Category
Protection degree
Plugging cycles
Shielding
Housing main material
Contact surface
Connection cross-section, flexible, min. / max.
Connection cross-section, solid, min. / max.
Insulation diameter, min. / max.
Connector standard
Ambient temperature (operational)
PoE / PoE+
Approvals
Note

Cat.6 _A / Class E _A (ISO/IEC 11801 2010)
IP 67 with housing
750
360° all-round enclosure
Zinc diecast
Gold over nickel, Au ≥ 0.8 μm
AWG 26 / AWG 22
AWG 24 / AWG 22
0.85 mm...1.6 mm
IEC 60603-7-51
-40 °C...70 °C
conforming to IEEE 802.3af
CULUS

Cat.5 (ISO/IEC 11801)
IP 67 with housing
750
360° all-round enclosure
Zinc diecast
Gold over nickel, Au ≥ 0.8 μm
AWG 26 / AWG 22
AWG 24 / AWG 22
0.85 mm...1.6 mm
IEC 60603-7-51
-40 °C...70 °C
conforming to IEEE 802.3af
CULUS; GERMLLOYD

Ordering data

tool-free
TIA-A. Cat. 6 _A
TIA-B. Cat. 6 _A
PROFINET Cat. 5
Note

Type	Qty.	Order No.
IE-BI-RJ45-FJ-A	10	1962850000
IE-BI-RJ45-FJ-B	10	1963840000

Type	Qty.	Order No.
IE-BI-RJ45-FJ-P	10	1963830000

Accessories

Tools
 Optional pressing tool

Type	Qty.	Order No.
PWZ RJ45	1	1118040000

Type	Qty.	Order No.
PWZ RJ45	1	1118040000

Note

Note

Note

RJ45 flange inserts, coupling

- Cat. 6_A
- IP 20
- For housing variants 1, 4, 5, 14 and for FrontCom®

8-wire

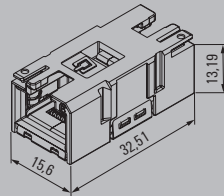
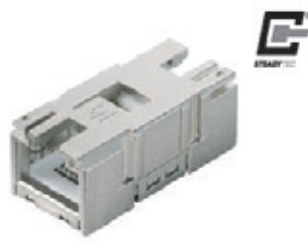

Technical data

Category
 Protection degree
 Plugging cycles
 Shielding
 Housing main material
 Contact surface
 Connection cross-section, flexible, min. / max.
 Connection cross-section, solid, min. / max.
 Insulation diameter, min. / max.
 Connector standard
 Ambient temperature (operational)
 PoE / PoE+
 Approvals

Cat.6_A / Class E_A (ISO/IEC 11801 2010)
 IP 67 with housing
 750
 360° all-round enclosure
 Zinc diecast
 Gold over nickel, Au ≥ 0.8 μm

IEC 60603-7-51
 -40 °C...70 °C
 conforming to IEEE 802.3af
 CULUS; GERMLLOYD

Note

Ordering data

tool-free
 Coupling

Note

Type	Qty.	Order No.
IE-BI-RJ45-C	10	1962840000

Accessories

Type	Qty.	Order No.
------	------	-----------

Note

Inserts

Plug inserts Hybrid

- Cat. 5
- IP 20
- For housing variants 1 (metal) and 14

Crimp

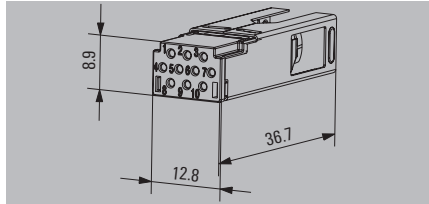



Technical data

Category	Cat.5 (ISO/IEC 11801)
Protection degree	IP 67 with housing
Plugging cycles	500
Shielding	360° all-round enclosure
Housing main material	Nickel silver, PA 66
Contact surface	Gold over nickel
No. of poles	10
Connection cross-section, flexible, min. / max.	AWG 27 / AWG 20
Connection diameter, flexible, min. / max.	0.08 mm ² / 0.75 mm ²
Insulation diameter, min. / max.	1 mm...2.2 mm
Ambient temperature (operational)	-40 °C...70 °C
Volume resistance	< 10 mΩ
Rated current	3 A per contact
Rated voltage	24 V
Contact resistance	≤ 5 mΩ
Approvals	CULUS; EAC
Note	

Ordering data

Note		
Type	Qty.	Order No.
IE-PI-HYB-10P	10	106890000
Order contacts separately		

Accessories

Crimp contacts	0.08...0.2 mm ²		
	0.2...0.5 mm ²		
	0.75 mm ²		
Crimping tool			
			
Type	Qty.	Order No.	
IE-PIC-HYB-S-0,2-300	300	1135150000	
IE-PIC-HYB-S-0,5-300	300	1096180000	
IE-PIC-HYB-S-0,75-300	300	1068950000	
HTF HYB	1	1119580000	

Note

Flange inserts Hybrid

- Cat. 5
- IP 20
- For housing variants 1 (metal) and 14

Module

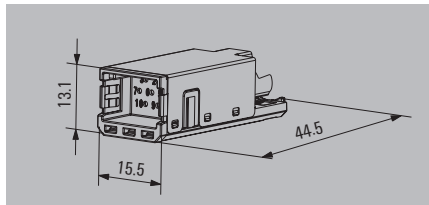

Technical data

Category	Cat.5 (ISO/IEC 11801)
Protection degree	IP 67 with housing
Plugging cycles	500
Shielding	360° all-round enclosure
Housing main material	Zinc diecast, Nickel silver, PA 66
Contact surface	Gold over nickel
No. of poles	10
Connection cross-section, flexible, min. / max.	AWG 27 / AWG 20
Connection diameter, flexible, min. / max.	0.08 mm ² / 0.75 mm ²
Insulation diameter, min. / max.	1 mm...2.2 mm
Rated current	3 A per contact
Rated voltage	24 V
Contact resistance	≤ 10 mΩ
Volume resistance	< 10 mΩ
Ambient temperature (operational)	-40 °C...70 °C
Approvals	CULUS

Note

Ordering data

Note

Type	Qty.	Order No.
IE-BI-HYB-10P	10	1069010000
Order contacts separately		

Accessories

Crimp contacts	
	0.08...0.2 mm ²
	0.2...0.5 mm ²
	0.75 mm ²

Crimping tool	
	

Type	Qty.	Order No.
IE-BIC-HYB-P-0,2-300	300	1135160000
IE-BIC-HYB-P-0,5-300	300	1096150000
IE-BIC-HYB-P-0,75-300	300	1068970000
HTF HYB	1	1119580000

Note

Note

Inserts

Flange inserts USB

- Cat. 6_A
- IP 20
- For housing variants 1, 4, 5, 14 and for FrontCom

Coupling USB A/A



Coupling USB A/B

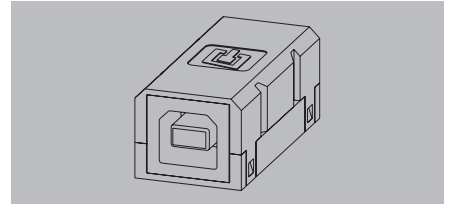
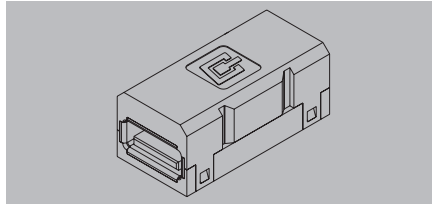
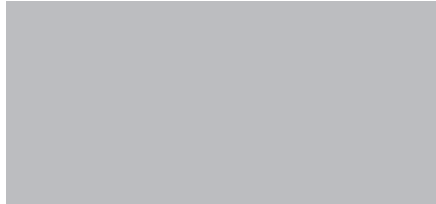

Technical data

Protection degree
Shielding
Ambient temperature (operational)
Connection 1 / 2
Connector standard
Approvals

IP 67 with housing
360° all-round enclosure
-40 °C...70 °C
USB A / USB A
IEC 61076-3-107
GERMLLOYD

IP 67 with housing
360° all-round enclosure
-40 °C...70 °C
USB A / USB B
IEC 61076-3-107
GERMLLOYD

Note

Ordering data

	USB 2.0
	USB 3.0

Type	Qty.	Order No.
IE-BI-USB-A	10	1019570000
IE-BI-USB-3.0-A	1	1487920000

Type	Qty.	Order No.
IE-BI-USB-AB	10	1131380000

Note

Accessories

Type	Qty.	Order No.

Type	Qty.	Order No.

Note

Plug inserts SC

- IP 20
- For variant 1, 4 and 14 housings

Plug inserts SC, fibre optics



Plug inserts SC, POF

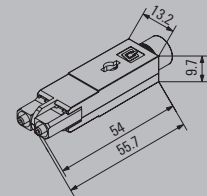
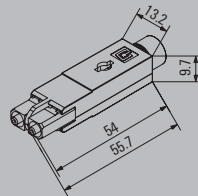

Technical data

Protection degree
 Housing main material
 Plugging cycles
 Ambient temperature (operational)
 Connector standard
 Approvals

Note

IP 67 with housing
 Zinc diecast
 1000
 -40 °C...70 °C
 IEC 61754-24
 EAC; UL

IP 67 with housing
 Zinc diecast
 1000
 -40 °C...70 °C
 IEC 61754-24
 EAC; UL

Ordering data

Singlemode
 Multimode
 POF

Note

Type	Qty.	Order No.
IE-PI-SCRJ-SM	10	1067390000
IE-PI-SCRJ-MM	10	1067380000

Type	Qty.	Order No.
IE-PI-SCRJ-POF	10	1067410000

Accessories

Tools

POF tool set
 Crimping tool POF
 Fibre-optic tool case

Replacement ferrule



Type	Qty.	Order No.
IE-CTC-SCST-GOF	1	1032030000

Type	Qty.	Order No.
TOOL SET IE-POF	1	1208930000
HTX-IE-POF	1	1208870000

IE-SCRJ-HP67-POF-100	100	1278430000
----------------------	-----	------------

Note

Inserts

Flange inserts SC

- IP 20
- SC-RJ on 2 SC
- For variant 1, 4 and 14 housings

Flange inserts SC

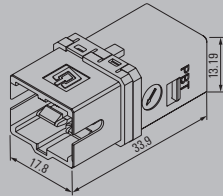

Technical data

Protection degree
 Housing main material
 Plugging cycles
 Ambient temperature (operational)
 Approvals

IP 67 with housing
 PA
 1000
 -40 °C...70 °C

Note

Ordering data

Flange insert	
	Singlemode
	Multimode/POF

Type	Qty.	Order No.
IE-BI-SCRJ2SC-SM-C	10	1962870000
IE-BI-SCRJ2SC-MM-C	10	1964430000

Note

Accessories

Type	Qty.	Order No.

Note

Plug inserts LC

- IP 20
- For variant 1, 4 and 14 housings

Plug inserts LC

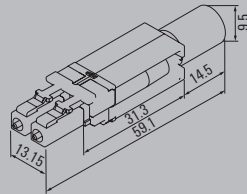

Technical data

Protection degree
 Housing main material
 Plugging cycles
 Ambient temperature (operational)
 Connector standard
 Approvals

IP 67 with housing
 PBT diecast zinc
 1000
 -40 °C...70 °C
 IEC 61754-20
 EAC

Note

Ordering data

Plug insert	
	Singlemode
	Multimode

Type	Qty.	Order No.
IE-PI-2LC-SM	10	1962790000
IE-PI-2LC-MM	10	1962780000

Note

Accessories

Tools	
	Crimping pliers GOF LC
	Fibre-optic tool case

Type	Qty.	Order No.
IE-CT-LC-GOF	1	9205330000
IE-CTC-SCST-GOF	1	1032030000

Note

Inserts

Flange inserts LC

- IP 20
- For variant 1, 4 and 14 housings

Flange inserts LC

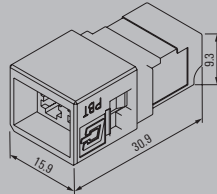

Technical data

Protection degree
 Housing main material
 Plugging cycles
 Ambient temperature (operational)
 Connector standard
 Approvals

IP 67 with housing
 PBT diecast zinc
 1000
 -40 °C...70 °C
 IEC 61754-20

Note

Ordering data

Flange insert	
	Singlemode
	Multimode

Type	Qty.	Order No.
IE-BH-LCD-SM-C	10	1962880000
IE-BH-LCD-MM-C	10	1964420000

Note

Accessories

Tools	
	Fibre-optic tool case
	Crimping pliers GOF LC



Type	Qty.	Order No.
IE-CTC-SCST-GOF	1	1032030000
IE-CT-LC-GOF	1	9205330000

Note

PushPull Power

Plug PushPull Power

Power 24 V plug

Power 400 V plug

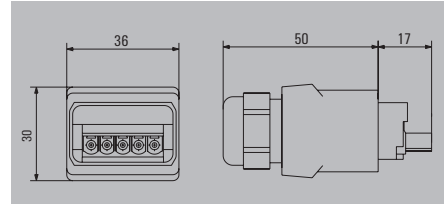
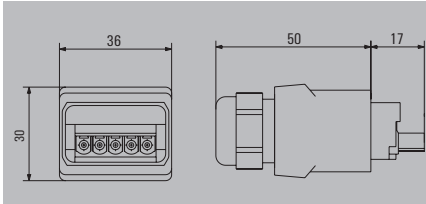

Technical data

General data

Protection degree
 Connector standard
 Ambient temperature (operational)
 No. of poles
 Wire connection cross-section, flexible, min./max.
 Sheath diameter, min. / max.
 Connection
 Approvals

IP 65
 in accordance with PROFINET specification
 -40 °C...70 °C
 5
 0.75 mm² / 2.5 mm²
 9 mm / 13 mm
 Tension clamp
 EAC; UR

IP 65
 in accordance with PROFINET specification
 -40 °C...70 °C
 5
 0.75 mm² / 2.5 mm²
 9 mm / 13 mm
 Tension clamp
 EAC; UR

Material properties

Housing base material
 Sealing material
 Cable sealing material
 Contact material / Contact surface
 UL 94 flammability rating
 Pollution severity level
 Plugging cycles

Zinc diecast, nickel-plated
 NBR
 TPE
 Copper alloy / Gold over nickel
 V-2
 2
 ≤ 100

Zinc diecast, nickel-plated
 NBR
 TPE
 Copper alloy / Gold over nickel
 V-2
 2
 ≤ 100

Electrical properties*

Current-carrying capacity at 50 °C
 Rated voltage

16 A
 24 V

16 A
 400 V

Note

We recommend using 10-mm-long wire-end ferrules

We recommend using 10-mm-long wire-end ferrules

Ordering data - Sets

Note

Type	Qty.	Order No.
IE-PS-VAPM-24V	10	1068910000

Type	Qty.	Order No.
IE-PS-VAPM-400V	10	1323940000

Ordering data - Empty housings

Note

Type	Qty.	Order No.

Type	Qty.	Order No.

Accessories

Note

Flange PushPull Power

Power 24 V flange

Power 400 V flange

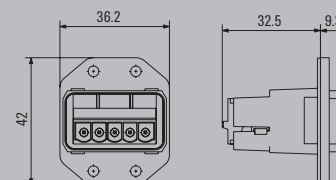
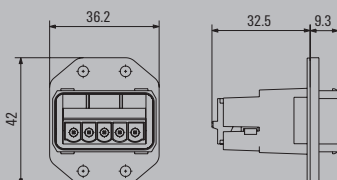

Technical data

General data	
Protection degree	IP 67
Connector standard	in accordance with PROFINET specification
Ambient temperature (operational)	-40 °C...70 °C
No. of poles	5
Connection diameter, flexible, min. / max.	0.75 mm ² / 2.5 mm ²
Connection 1	Tension clamp
Approvals	UR
Installation	4 screws
Material properties	
Housing base material	Zinc diecast, nickel-plated
Sealing material	NBR
Cable sealing material	TPE
Contact carrier material	PA
Contact material / Contact surface	Copper alloy / Gold over nickel
UL 94 flammability rating	V-2
Pollution severity level	2
Plugging cycles	≤ 100
Electrical properties*	
Current-carrying capacity at 50 °C	16 A
Rated voltage	24 V
Note	We recommend using 10-mm-long wire-end ferrules

General data		
Protection degree	IP 67	
Connector standard	in accordance with PROFINET specification	
Ambient temperature (operational)	-40 °C...70 °C	
No. of poles	5	
Connection diameter, flexible, min. / max.	0.75 mm ² / 2.5 mm ²	
Connection 1	Tension clamp	
Approvals	UR	
Installation	4 screws	
Material properties		
Housing base material	Zinc diecast, nickel-plated	
Sealing material	NBR	
Cable sealing material	TPE	
Contact carrier material	PA	
Contact material / Contact surface	Copper alloy / Gold over nickel	
UL 94 flammability rating	V-2	
Pollution severity level	2	
Plugging cycles	≤ 100	
Electrical properties*		
Current-carrying capacity at 50 °C	16 A	
Rated voltage	24 V	
Note	We recommend using 10-mm-long wire-end ferrules	

General data		
Protection degree	IP 67	
Connector standard	in accordance with PROFINET specification	
Ambient temperature (operational)	-40 °C...70 °C	
No. of poles	5	
Connection diameter, flexible, min. / max.	0.75 mm ² / 2.5 mm ²	
Connection 1	Tension clamp	
Approvals	UR	
Installation	4 screws	
Material properties		
Housing base material	Zinc diecast, nickel-plated	
Sealing material	NBR	
Cable sealing material	TPE	
Contact carrier material	PA	
Contact material / Contact surface	Copper alloy / Gold over nickel	
UL 94 flammability rating	V-2	
Pollution severity level	2	
Plugging cycles	≤ 100	
Electrical properties*		
Current-carrying capacity at 50 °C	16 A	
Rated voltage	400 V	
Note	We recommend using 10-mm-long wire-end ferrules	

Ordering data - Sets

Note

Type	Qty.	Order No.
IE-BSS-VAPM-24V	10	1068930000

Type	Qty.	Order No.
IE-BSS-VAPM-400V	10	1323950000

Ordering data - Empty housings

Device flange
Note

Type	Qty.	Order No.
IE-BHD-VAPM	10	1068920000

Type	Qty.	Order No.
IE-BHD-VAPM	10	1068920000

Accessories

Dust protection cap

Type	Qty.	Order No.
IE-BP-VAPP	10	1068930000

Type	Qty.	Order No.
IE-BP-VAPP	10	1068930000

Note

Note

Note

IP 65 connection components / FreeCon connectivity components

Overview

IP 65 connection components / FreeCon connecting components	FreeCon Passive V14	K.2
	FreeCon Active PROFINET	K.9
	FreeCon Contactless Power	K.10
	V1 junction boxes	K.11
	V4 junction boxes	K.13
	V5 junction boxes	K.15
	V6 junction boxes	K.16

FreeCon V14 - junction box

Double junction box, Power / RJ45

Single junction box, RJ45

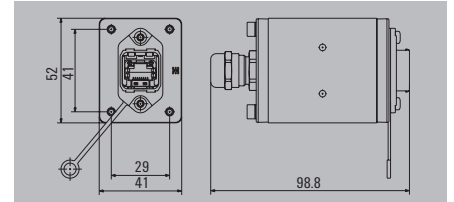
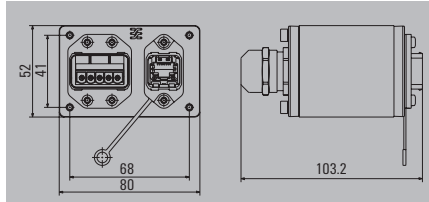

Technical data

General data	
Housing main material	Aluminium profile, Cover: die-cast zinc, painted
Protection degree	IP 65
Ambient temperature (operational)	-40 °C...70 °C
Connector standard	IEC 61076-3-117 Var. 14, IEC 60603-7-5
Approvals	CULUS
Technical specifications power connector	
Housing base material	Zinc diecast, nickel-plated
Sealing material	NBR
Contact material	Copper alloy
Contact carrier material	PA
Contact surface	Gold over nickel
Plugging cycles	5
No. of poles	6 mm / 12 mm
Sheath diameter, min. / max.	Tension clamp
Connection	16 A
Electrical properties power connector	
Current-carrying capacity at 50 °C	24 V
Rated voltage	
Technical specifications for RJ45 module	
Housing base material	Zinc diecast, nickel-plated
Contact surface	Gold over nickel
Connection cross-section, flexible, min. / max.	AWG 26 / AWG 22
Connection 1	IDC
Sheath diameter, min./max.	5 mm / 10 mm
Electrical properties for RJ45 module	
Category	Cat.5 (ISO/IEC 11801)
Contact resistance	≤ 20 mΩ
Insulation resistance	> 500 MΩ
Dielectric strength, contact - contact, max.	≤ 1000 V DC
Dielectric strength, contact - contact, min.	≤ 1500 V DC
Current carrying capacity	1 A
Note	

General data		
Housing main material	Aluminium profile, Cover: die-cast zinc, painted	
Protection degree	IP 65	
Ambient temperature (operational)	-40 °C...70 °C	
Connector standard	IEC 61076-3-117 Var. 14, IEC 60603-7-5	
Approvals	CULUS	
Technical specifications power connector		
Housing base material	Zinc diecast, nickel-plated	
Sealing material	NBR	
Contact material	Copper alloy	
Contact carrier material	PA	
Contact surface	Gold over nickel	
Plugging cycles	5	
No. of poles	6 mm / 12 mm	
Sheath diameter, min. / max.	Tension clamp	
Connection	16 A	
Rated voltage	24 V	
Technical specifications for RJ45 module		
Housing base material	Zinc diecast, nickel-plated	
Contact surface	Gold over nickel	
Connection cross-section, flexible, min. / max.	AWG 26 / AWG 22	
Connection 1	IDC	
Sheath diameter, min./max.	5 mm / 10 mm	
Electrical properties for RJ45 module		
Category	Cat.5 (ISO/IEC 11801)	
Contact resistance	≤ 20 mΩ	
Insulation resistance	> 500 MΩ	
Dielectric strength, contact - contact, max.	≤ 1000 V DC	
Dielectric strength, contact - contact, min.	≤ 1500 V DC	
Current carrying capacity	1 A	
Note		

General data		
Housing main material	Aluminium profile, Cover: die-cast zinc, painted	
Protection degree	IP 65	
Ambient temperature (operational)	-40 °C...70 °C	
Connector standard	IEC 61076-3-117 Var. 14, IEC 60603-7-5	
Approvals	CULUS	
Technical specifications power connector		
Housing base material	Zinc diecast, nickel-plated	
Sealing material	NBR	
Contact material	Copper alloy	
Contact carrier material	PA	
Contact surface	Gold over nickel	
Plugging cycles	5	
No. of poles	6 mm / 12 mm	
Sheath diameter, min. / max.	Tension clamp	
Connection	16 A	
Rated voltage	24 V	
Technical specifications for RJ45 module		
Housing base material	Zinc diecast, nickel-plated	
Contact surface	Gold over nickel	
Connection cross-section, flexible, min. / max.	AWG 26 / AWG 22	
Connection 1	IDC	
Sheath diameter, min./max.	5 mm / 10 mm	
Electrical properties for RJ45 module		
Category	Cat.5 (ISO/IEC 11801)	
Contact resistance	≤ 20 mΩ	
Insulation resistance	> 500 MΩ	
Dielectric strength, contact - contact, max.	≤ 1000 V DC	
Dielectric strength, contact - contact, min.	≤ 1500 V DC	
Current carrying capacity	1 A	
Note		

Ordering data

Type	Qty.	Order No.
IE-CD-V14MRJ/VAPM24V-FJ	1	1068830000
Note		

Type	Qty.	Order No.
IE-CD-V14MRJ/VAPM24V-FJ	1	1068830000
Note		

Type	Qty.	Order No.
IE-CD-V14MRJ-FJ	1	1068880000
Note		

Accessories

Type	Qty.	Order No.
IE-CD-MA	10	1099580000
IE-BP-V14P	10	1058310000
IE-BP-VAPP	10	1068930000
Note		

Type	Qty.	Order No.
IE-CD-MA	10	1099580000
IE-BP-V14P	10	1058310000
IE-BP-VAPP	10	1068930000
Note		

Type	Qty.	Order No.
IE-CD-MA	10	1099580000
IE-BP-V14P	10	1058310000
Note		



FreeCon V14 - single junction box

RJ45 cable coupling

PushPull Power cable coupling

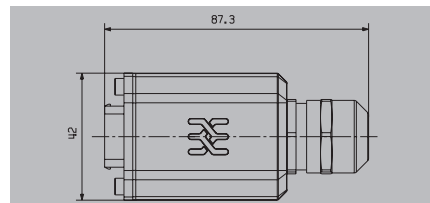
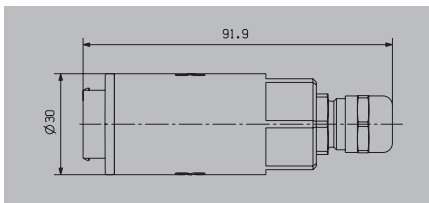

Technical data

General data	
Housing main material	diecast aluminium
Protection degree	IP 65
Ambient temperature (operational)	-40 °C...70 °C
Connector standard	IEC 61076-3-117 Var. 14, IEC 60603-7-5
Approvals	
Technical specifications power connector	
Housing base material	
Sealing material	
Contact material	
Contact carrier material	
Contact surface	
Plugging cycles	
No. of poles	
Sheath diameter, min. / max.	
Connection	
Electrical properties power connector	
Current-carrying capacity at 50 °C	
Rated voltage	
Technical specifications for RJ45 module	
Housing base material	Zinc diecast, nickel-plated
Contact surface	Gold over nickel
Connection cross-section, flexible, min. / max.	AWG 26 / AWG 22
Connection 1	IDC
Sheath diameter, min./max.	5 mm / 10 mm
Electrical properties for RJ45 module	
Category	Cat.5 (ISO/IEC 11801)
Contact resistance	≤ 20 mΩ
Insulation resistance	> 500 MΩ
Dielectric strength, contact - contact, max.	≤ 1000 V DC
Dielectric strength, contact - contact, min.	≤ 1500 V DC
Current carrying capacity	1 A
Note	

General data		
Housing main material	diecast aluminium	
Protection degree	IP 65	
Ambient temperature (operational)	-40 °C...70 °C	
Connector standard	IEC 61076-3-117 Var. 14, IEC 60603-7-5	
Approvals		
Technical specifications power connector		
Housing base material		Zinc diecast, nickel-plated
Sealing material		NBR
Contact material		Copper alloy
Contact carrier material		PA
Contact surface		Gold over nickel
Plugging cycles		
No. of poles		5
Sheath diameter, min. / max.		6 mm / 12 mm
Connection		Tension clamp
Electrical properties power connector		
Current-carrying capacity at 50 °C		16 A
Rated voltage		24 V
Technical specifications for RJ45 module		
Housing base material	Zinc diecast, nickel-plated	
Contact surface	Gold over nickel	
Connection cross-section, flexible, min. / max.	AWG 26 / AWG 22	
Connection 1	IDC	
Sheath diameter, min./max.	5 mm / 10 mm	
Electrical properties for RJ45 module		
Category	Cat.5 (ISO/IEC 11801)	
Contact resistance	≤ 20 mΩ	
Insulation resistance	> 500 MΩ	
Dielectric strength, contact - contact, max.	≤ 1000 V DC	
Dielectric strength, contact - contact, min.	≤ 1500 V DC	
Current carrying capacity	1 A	
Note		
We recommend using 10-mm-long wire-end ferrules		

General data		
Housing main material	diecast aluminium	
Protection degree	IP 65	
Ambient temperature (operational)	-40 °C...70 °C	
Connector standard	IEC 61076-3-117 Var. 14, IEC 60603-7-5	
Approvals		
Technical specifications power connector		
Housing base material		Zinc diecast, nickel-plated
Sealing material		NBR
Contact material		Copper alloy
Contact carrier material		PA
Contact surface		Gold over nickel
Plugging cycles		
No. of poles		5
Sheath diameter, min. / max.		6 mm / 12 mm
Connection		Tension clamp
Electrical properties power connector		
Current-carrying capacity at 50 °C		16 A
Rated voltage		24 V
Technical specifications for RJ45 module		
Housing base material	Zinc diecast, nickel-plated	
Contact surface	Gold over nickel	
Connection cross-section, flexible, min. / max.	AWG 26 / AWG 22	
Connection 1	IDC	
Sheath diameter, min./max.	5 mm / 10 mm	
Electrical properties for RJ45 module		
Category	Cat.5 (ISO/IEC 11801)	
Contact resistance	≤ 20 mΩ	
Insulation resistance	> 500 MΩ	
Dielectric strength, contact - contact, max.	≤ 1000 V DC	
Dielectric strength, contact - contact, min.	≤ 1500 V DC	
Current carrying capacity	1 A	
Note		
We recommend using 10-mm-long wire-end ferrules		

Ordering data

Type	Qty.	Order No.
IE-CC-V14M-RJ45-FJ-P	1	1990600000

Type	Qty.	Order No.
IE-CC-V14M-RJ45-FJ-P	1	1990600000

Type	Qty.	Order No.
IE-CC-VAPM-24V	1	1990630000

Accessories

Mounting frame	
Dust protection cap	
Note	

Type	Qty.	Order No.
IE-CC-V14M-MF	1	1990620000
IE-BP-V14P	10	1058310000

Type	Qty.	Order No.
IE-CC-VAPM-MF	1	1990640000
IE-BP-VAPP	10	1068930000

FreeCon Passive V14

FreeCon V14 - coupling

Double coupling, Power / RJ45

Single coupling, RJ45

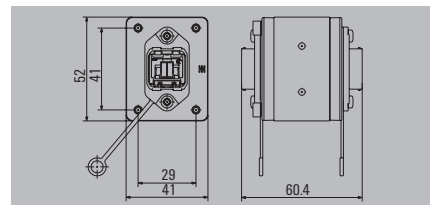
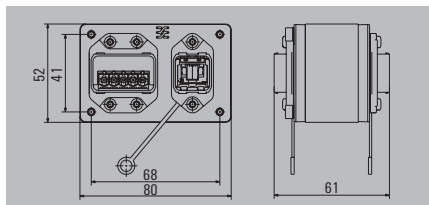

Technical data

General data	
Housing main material	Aluminium profile, Cover: die-cast zinc, painted
Protection degree	IP 65
Ambient temperature (operational)	-40 °C...70 °C
Connector standard	IEC 61076-3-117 Var. 14, IEC 60603-7-5
Approvals	CULUS
Technical specifications power connector	
Housing base material	Zinc diecast, nickel-plated
Sealing material	NBR
Contact material	Copper alloy
Contact carrier material	PA
Contact surface	Gold over nickel
Plugging cycles	≥ 100
No. of poles	5
Sheath diameter, min. / max.	6 mm / 12 mm
Connection	Tension clamp
Electrical properties power connector	
Current-carrying capacity at 50 °C	16 A
Rated voltage	24 V
Technical data for RJ45 coupling	
Housing base material	Zinc diecast, PA 66
Electrical properties RJ45 coupling	
Category	Cat.6 _A / Class E _A (ISO/IEC 11801 2010)
Contact resistance	≤ 20 mΩ
Contact surface	Gold over nickel
Insulation resistance	> 500 MΩ
Dielectric strength, contact - contact, min.	≥ 1000 V DC
Dielectric strength, contact - shielding, max.	≥ 1500 V DC
Current carrying capacity	1 A
Note	

General data		
Housing main material	Aluminium profile, Cover: die-cast zinc, painted	
Protection degree	IP 65	
Ambient temperature (operational)	-40 °C...70 °C	
Connector standard	IEC 61076-3-117 Var. 14, IEC 60603-7-5	
Approvals	CULUS	
Technical specifications power connector		
Housing base material	Zinc diecast, nickel-plated	
Sealing material	NBR	
Contact material	Copper alloy	
Contact carrier material	PA	
Contact surface	Gold over nickel	
Plugging cycles	≥ 100	
No. of poles	5	
Sheath diameter, min. / max.	6 mm / 12 mm	
Connection	Tension clamp	
Electrical properties power connector		
Current-carrying capacity at 50 °C	16 A	
Rated voltage	24 V	
Technical data for RJ45 coupling		
Housing base material	Zinc diecast, PA 66	
Electrical properties RJ45 coupling		
Category	Cat.6 _A / Class E _A (ISO/IEC 11801 2010)	
Contact resistance	≤ 20 mΩ	
Contact surface	Gold over nickel	
Insulation resistance	> 500 MΩ	
Dielectric strength, contact - contact, min.	≥ 1000 V DC	
Dielectric strength, contact - shielding, max.	≥ 1500 V DC	
Current carrying capacity	1 A	
Note		

General data		
Housing main material	Aluminium profile, Cover: die-cast zinc, painted	
Protection degree	IP 65	
Ambient temperature (operational)	-40 °C...70 °C	
Connector standard	IEC 61076-3-117 Var. 14, IEC 60603-7-5	
Approvals	CULUS	
Technical specifications power connector		
Housing base material	Zinc diecast, nickel-plated	
Sealing material	NBR	
Contact material	Copper alloy	
Contact carrier material	PA	
Contact surface	Gold over nickel	
Plugging cycles	≥ 100	
No. of poles	5	
Sheath diameter, min. / max.	6 mm / 12 mm	
Connection	Tension clamp	
Electrical properties power connector		
Current-carrying capacity at 50 °C	16 A	
Rated voltage	24 V	
Technical data for RJ45 coupling		
Housing base material	Zinc diecast, PA 66	
Electrical properties RJ45 coupling		
Category	Cat.6 _A / Class E _A (ISO/IEC 11801 2010)	
Contact resistance	≤ 20 mΩ	
Contact surface	Gold over nickel	
Insulation resistance	> 500 MΩ	
Dielectric strength, contact - contact, min.	≥ 1000 V DC	
Dielectric strength, contact - shielding, max.	≥ 1500 V DC	
Current carrying capacity	1 A	
Note		

Ordering data

Type	Qty.	Order No.
IE-CD-V14MRJ/VAPM24V-C-MA	1	1068820000
Note		
Including mounting foot		

Type	Qty.	Order No.
IE-CD-V14MRJ/VAPM24V-C-MA	1	1068820000
Note		
Including mounting foot		

Type	Qty.	Order No.
IE-CD-V14MRJ-C-MA	1	1068870000
Note		
Including mounting foot		

Accessories

Dust protection cap		
		
Type	Qty.	Order No.
IE-BP-V14P	10	1058310000
IE-BP-VAPP	10	1068930000

Type	Qty.	Order No.
IE-BP-V14P	10	1058310000
IE-BP-VAPP	10	1068930000

Type	Qty.	Order No.
IE-BP-V14P	10	1058310000

Note		
------	--	--

Note		
------	--	--

Note		
------	--	--

FreeCon V14 single coupling

Single coupling, SCRJ

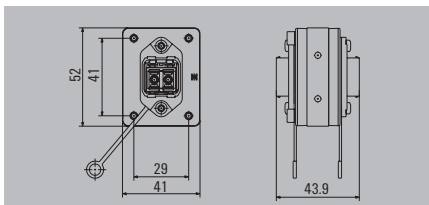

Technical data

General data	
Housing main material	Aluminium profile, Cover: die-cast zinc, painted
Protection degree	IP 65
Ambient temperature (operational)	-40...70 °C
Connector standard	IEC 61076-3-117 Var. 14, IEC 61754-24
Approvals	
Technical specifications - fibre-optic coupler	
Housing base material (fibre-optic coupling)	PA
Plugging cycles (fibre-optic coupling)	≥ 500
Seal material (fibre-optic coupling)	NBR
Connection 1 / 2	SCRJ / SCRJ
Insertion attenuation (fibre-optic coupling)	< 0.2 dB
Fibre type	Multimode, POF
Note	

Ordering data

Note	

Type	Qty.	Order No.
IE-CD-V14MSCRJ-MM-C-MA	1	1318150000

Accessories

Dust protection cap	
	
Note	

Type	Qty.	Order No.
IE-BP-V14P	10	1058310000

Note	
------	--

--

FreeCon Passive V14

FreeCon V14 - Power

Y-distributor, Power

Single coupling, Power

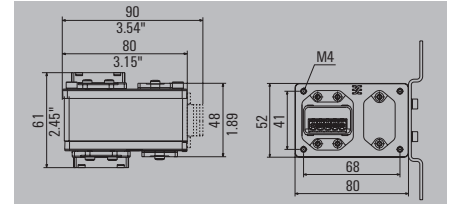
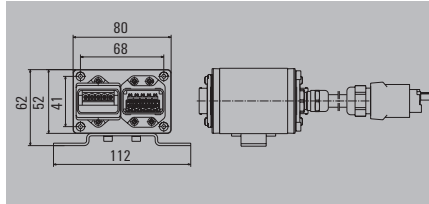

Technical data

General data

Housing main material
Protection degree
Ambient temperature (operational)
Connector standard
Approvals

Technical specifications power connector

Housing base material
Sealing material
Cable sealing material
Contact material
Contact carrier material
Contact surface
UL 94 flammability rating
Plugging cycles
Pollution severity level

Electrical properties power connector

Current-carrying capacity at 50 °C
Rated voltage
No. of poles

Note

Aluminium profile, Cover: die-cast zinc, painted
IP 65
-40...70 °C
in accordance with PROFINET specification

Zinc diecast, nickel-plated
NBR
TPE
Copper alloy
PA
Gold over nickel

V-0
≥ 100
2

16 A @ 20 °C
24 V
5

Aluminium profile, Cover: die-cast zinc, painted
IP 65, If thread-locking fluid is used
-40...70 °C
in accordance with PROFINET specification

Zinc diecast, nickel-plated
NBR
TPE
Copper alloy
PA
Gold over nickel

V-0
≥ 100
2

16 A @ 20 °C
24 V
5

Ordering data

Note

Type	Qty.	Order No.
IE-CD-VAPM24V-Y-MA	1	1297010000

Type	Qty.	Order No.
IE-CD-VAPM24V-C-MA	1	1397690000

Accessories

Dust protection cap



Type	Qty.	Order No.
IE-BP-VAPP	10	1068930000

Type	Qty.	Order No.
IE-BP-VAPP	10	1068930000

Note

FreeCon V14 - junction box

Single junction box, Hybrid

Hybrid cable coupling

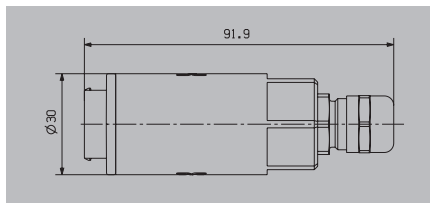
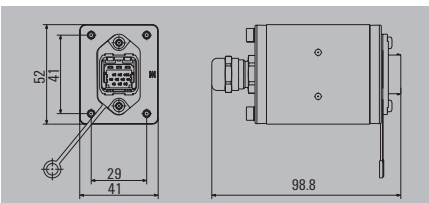

Technical data

General data	
Housing main material	Aluminium profile, Cover: die-cast zinc, painted
Protection degree	IP 65
Ambient temperature (operational)	-40 °C...70 °C
Approvals	CULUS
Technical specifications hybrid connector	
Housing base material	Zinc diecast (flange), PA 66
Sealing material	NBR
Contact material	Copper alloy
Contact surface	Gold over nickel
Plugging cycles	500
Pole count	10
Connection cross-section, flexible, min. / max.	AWG 27 / AWG 20
Connection cross-section, flexible, min. / max.	0.08 mm ² / 0.75 mm ²
Electrical properties hybrid connector	
Rated current (hybrid connector)	3 A per contact
Rated voltage (DIN EN 61984)	24 V
Contact resistance	≤ 10 mΩ
Note	

General data		
Housing main material	diecast aluminium	
Protection degree	IP 65	
Ambient temperature (operational)	-40 °C...70 °C	
Technical specifications hybrid connector		
Housing base material	Zinc diecast (flange), PA 66	
Sealing material	NBR	
Contact material	Copper alloy	
Contact surface	Gold over nickel	
Plugging cycles	500	
Pole count	10	
Connection cross-section, flexible, min. / max.	AWG 27 / AWG 20	
Connection cross-section, flexible, min. / max.	0.08 mm ² / 0.75 mm ²	
Electrical properties hybrid connector		
Rated current (hybrid connector)	3 A per contact	
Rated voltage (DIN EN 61984)	24 V	
Contact resistance	≤ 10 mΩ	
Note		

General data		
Housing main material	diecast aluminium	
Protection degree	IP 65	
Ambient temperature (operational)	-40 °C...70 °C	
Technical specifications hybrid connector		
Housing base material	Zinc diecast (flange), PA 66	
Sealing material	NBR	
Contact material	Copper alloy	
Contact surface	Gold over nickel	
Plugging cycles	500	
Pole count	10	
Connection cross-section, flexible, min. / max.	AWG 27 / AWG 20	
Connection cross-section, flexible, min. / max.	0.08 mm ² / 0.75 mm ²	
Electrical properties hybrid connector		
Rated current (hybrid connector)	3 A per contact	
Rated voltage (DIN EN 61984)	24 V	
Contact resistance	≤ 10 mΩ	
Note		

Ordering data

Type	Qty.	Order No.
IE-CD-V14M-HYB-10P-FJ	1	1068850000
Note		

Type	Qty.	Order No.
IE-CD-V14M-HYB-10P-FJ	1	1068850000
Order contacts separately		

Type	Qty.	Order No.
IE-CC-V14M-HYB-10P-FJ	1	1990610000
Order contacts separately		

Accessories

Mounting foot	
Crimp contacts	
	0.08...0.2 mm ²
	0.2...0.5 mm ²
	0.75 mm ²
Crimping tool	
Dust protection cap	
Mounting frame	
Note	

Type	Qty.	Order No.
IE-CD-MA	10	1099580000
IE-BIC-HYB-P-0,2-300	300	1135160000
IE-BIC-HYB-P-0,5-300	300	1096150000
IE-BIC-HYB-P-0,75-300	300	1068970000
HTF HYB	1	1119580000
IE-BP-V14P	10	1058310000
Note		

Type	Qty.	Order No.
IE-BIC-HYB-P-0,2-300	300	1135160000
IE-BIC-HYB-P-0,5-300	300	1096150000
IE-BIC-HYB-P-0,75-300	300	1068970000
HTF HYB	1	1119580000
IE-BP-V14P	10	1058310000
IE-CC-V14M-MF	1	1990620000
Note		



FreeCon V14 single coupling

Single coupling, hybrid

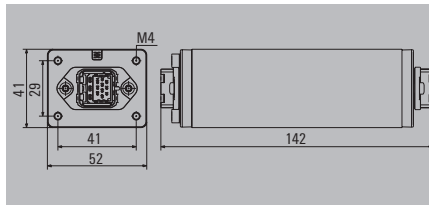

Technical data

General data	
Housing main material	Aluminium profile, Cover: die-cast zinc, painted
Protection degree	IP 65
Ambient temperature (operational)	-40...70 °C
Technical specifications hybrid connector	
Housing base material	Zinc diecast (flange), PA 66
Sealing material	NBR
Contact material	Copper alloy
Contact surface	Gold over nickel
Plugging cycles	500
Electrical properties hybrid connector	
Rated current (hybrid connector)	3 A per contact
Rated voltage (DIN EN 61984)	24
Contact resistance	≤ 10 mΩ
Pole count	10
Approvals	
Note	

Ordering data		
Type	Qty.	Order No.
IE-CD-V14MHYB-10P-C-MA	1	1068840000
Note		

Ordering data

Ordering data		
Type	Qty.	Order No.
IE-CD-V14MHYB-10P-C-MA	1	1068840000
Note		

Ordering data		
Type	Qty.	Order No.
IE-CD-V14MHYB-10P-C-MA	1	1068840000
Note		

Accessories

Accessories		
Type	Qty.	Order No.
IE-BP-V14P	10	1058310000
Note		



Accessories		
Type	Qty.	Order No.
IE-BP-V14P	10	1058310000
Note		

Note

Note



FreeCon Active PROFINET
with diagnostics functionality

POF repeater

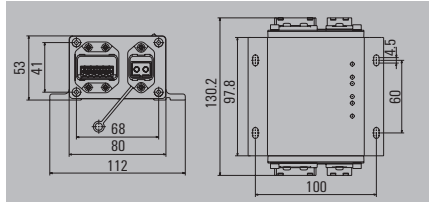

POF media converter

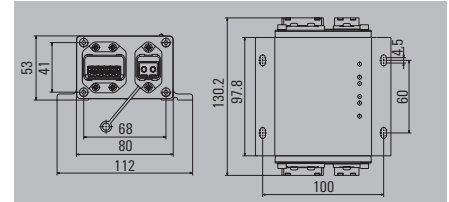

Technical data

General data	
Housing main material	
Weight	
Data interface	
Power interface	
Protection degree	
Ambient temperature (operational)	
Network standard	
Connector standard	
Electrical data	
Operating voltage	
Operational voltage range	
Current consumption	
Baud rate	
Protocol	
LED indicator	
Approvals	
Note	

Aluminium profile, Cover: die-cast zinc, painted
780 g
PROFINET PushPull SCRJ POF (V14)
PROFINET PushPull Power
IP 65
-20 °C...55 °C
IEC 61158, IEC 61784
IEC 61076-3-117 Var. 14, IEC 61754-24
24 V DC
18...30 V DC
200 mA typical
100 MB
PROFINET IRT
F01: port active, F02: port active, SF: general error, BF: bus error, US1: voltage 1 (electronics), US2: voltage 2
CULUS

Aluminium profile, Cover: die-cast zinc, painted
780 g
PROFINET PushPull SCRJ POF (V14), PROFINET PushPull RJ45 (V14)
PROFINET PushPull Power
IP 65
-20 °C...55 °C
IEC 61158, IEC 61784
IEC 61076-3-117 Var. 14, IEC 61754-24, IEC 60603-7-51
24 V DC
18...30 V DC
200 mA typical
100 MB
PROFINET IRT
P1: port active, P2: port active, SF: general error, BF: bus error, US1: voltage 1 (electronics), US2: voltage 2
CULUS

Ordering data

Type	Qty.	Order No.
IE-CDR-V14MSCPOF/VAPM-C	1	1253240000
Delivery incl. IP 67 protective caps		
Note		

Type	Qty.	Order No.
IE-CDR-V14MSCPOF/VAPM-C	1	1253240000
Delivery incl. IP 67 protective caps		

Type	Qty.	Order No.
IE-CDM-V14MRJSCP/VAPM-C	1	1324440000
Delivery incl. IP 67 protective caps		

Accessories

Type	Qty.	Order No.

Type	Qty.	Order No.

Type	Qty.	Order No.

Note

Note

Note

FreeCon Contactless Power

FreeCon Contactless

- Contactless power transmission via air gap

Primary side (base)

Secondary side (remote)

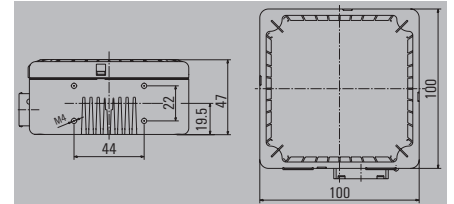
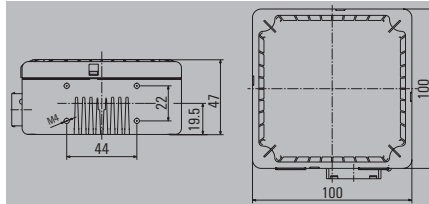

Technical data

General data

- Housing main material
- Technologie, version
- Loads
- Turn-on time
- Coupling time
- Air gap
- Power interface
- Protection degree
- Ambient temperature (operational)
- Weight

Electrical data

- Primary voltage
- Secondary voltage
- Secondary current
- Degree of efficiency
- LED indicator
- Approvals

Note

Ordering data

Note

Accessories

Plug

PushPull Power

preliminary technical data

- Diecast zinc, painted, Cover PBT
- Inductive resonance coupling
- Inductive and resistive loads
- 1 s
- 0...4 mm
- PROFINET PushPull Power
- IP 65
- 10...45 °C Consider derating
- 1000 g

24 V DC (21.6...26.4 V DC)

max. 91 %

Status indication via multi-coloured LED

Note

Type	Qty.	Order No.
IE-CL240W-PP-BASE	1	1547440000

Type	Qty.	Order No.
IE-PS-VAPM-24V	10	1068910000

preliminary technical data

- Diecast zinc, painted, Cover PBT
- Inductive resonance coupling
- Inductive and resistive loads
- < 500 ms
- 0...4 mm
- PROFINET PushPull Power
- IP 65
- 10...45 °C Consider derating
- 1000 g

24 V DC (19.2...28.8 V DC)

10 A

max. 91 %

Status indication via multi-coloured LED

Note

Type	Qty.	Order No.
IE-CL240W-PP-REMOTE	1	1547450000

Type	Qty.	Order No.
IE-PS-VAPM-24V	10	1068910000

Note

V1 junction boxes - plastic

Single junction box

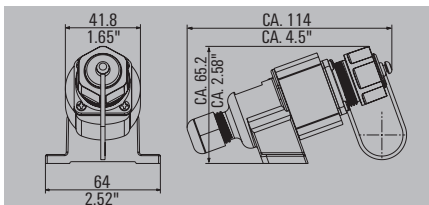

Technical data

Protection degree
Housing main material
Plugging cycles
Ambient temperature (operational)
Connector standard
Sheath diameter min. / max.
Approvals
Note

IP 67
PA UL 94 V0
750
-40 °C...70 °C
IEC 61076-3-106 Var. 1
6 mm / 9.5 mm
Note

Ordering data

Variant 1
Junction box
Note

Type	Qty.	Order No.
IE-OP-V01P-1S	10	1061830000
Order RJ45 modules separately		

Accessories

Inserts, Data
 RJ45 module EIA/TIA T568 B
RJ45 module PROFINET
RJ45 module EIA/TIA T568 A

Type	Qty.	Order No.
IE-BI-RJ45-FJ-B	10	1963840000
IE-BI-RJ45-FJ-P	10	1963830000
IE-BI-RJ45-FJ-A	10	1962850000

Note

Note

V1 junction boxes

V1 junction boxes - metal

- IP 67
- For wall or floor mounting

Double junction box

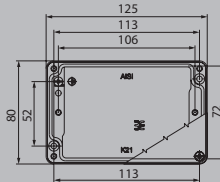

Single junction box

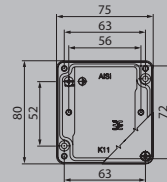

Technical data

Protection degree
Housing main material
Colour
Type of mounting
Ambient temperature (operational)
Plugging cycles
Connector standard
Sheath diameter min. / max.
Approvals
Note

IP 67
Al - Si 12
Grey
Floor-mounted, Wall mounting
-40 °C...70 °C
750
IEC 61076-3-106 Var. 1
5 mm / 10 mm
GOSTME25
Note

IP 67
Al - Si 12
Grey
Floor-mounted, Wall mounting
-40 °C...70 °C
750
IEC 61076-3-106 Var. 1
5 mm / 10 mm
Note

Ordering data

Variant 1
Note

Type	Qty.	Order No.
IE-OM-V01M-K21-2S	1	1966330000
RJ45 modules can be ordered separately		

Type	Qty.	Order No.
IE-OM-V01M-K11-1S	1	1966300000
RJ45 modules can be ordered separately		

Accessories

Inserts, Data	
	RJ45 module EIA/TIA T568 B
	RJ45 module PROFINET
	RJ45 module EIA/TIA T568 A

Type	Qty.	Order No.
IE-BI-RJ45-FJ-B	10	1963840000
IE-BI-RJ45-FJ-P	10	1963830000
IE-BI-RJ45-FJ-A	10	1962850000

Type	Qty.	Order No.
IE-BI-RJ45-FJ-B	10	1963840000
IE-BI-RJ45-FJ-P	10	1963830000
IE-BI-RJ45-FJ-A	10	1962850000

Note

Note

Note

FreeCon V4 junction boxes

Single coupling, RJ45

Single junction box

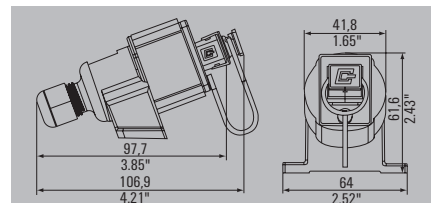
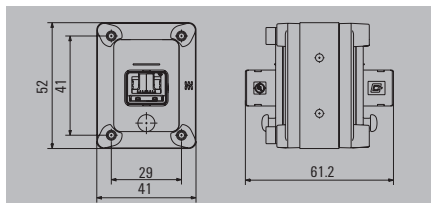

Technical data

General data	
Plugging cycles	
Housing main material	
Contact surface	
UL 94 flammability rating	
Connector standard	
Protection degree	
Ambient temperature (operational)	
Sheath diameter min. / max.	
Approvals	
Electrical properties for RJ45 module	
Category	
Contact resistance	
Insulation resistance	
Dielectric strength, contact - contact, min.	
Dielectric strength, contact - shielding, max.	
Current carrying capacity	
Material properties RJ45 coupling	
Housing base material	
Note	

750
Aluminium profile, Cover: die-cast zinc, painted
Gold over nickel
IEC 61076-3-106 Var. 4, IEC 60603-7-5
IP 65
-40 °C...70 °C
CULUS
Cat.6 _n / Class E _x (ISO/IEC 11801 2010)
≤ 20 mΩ
> 500 MΩ
≥ 1000 V DC
≥ 1500 V DC
1 A
Zinc diecast, PA 66

750
PA
Gold over nickel
V-0
IEC 61076-3-106 Var. 4
IP 67
-40 °C...70 °C
6 mm / 9.5 mm

Ordering data

Junction box	
Coupling	
Note	

Type	Qty.	Order No.
IE-CD-V04PRJ-C-MA	1	1122710000
Including mounting foot		

Type	Qty.	Order No.
IE-OP-V04P-1S	10	1045780000
Order RJ45 modules separately, IP 67 protective cap included in delivery		

Accessories

Dust protection cap	
	Flange-mounted housing protective cap
Inserts, Data	
	RJ45 module PROFINET
	RJ45 module EIA/TIA T568 A
	RJ45 module EIA/TIA T568 B

Type	Qty.	Order No.
IE-BP-V04P	10	1963900000

Type	Qty.	Order No.
IE-BP-V04P	10	1963900000
IE-BI-RJ45-FJ-P	10	1963830000
IE-BI-RJ45-FJ-A	10	1962850000
IE-BI-RJ45-FJ-B	10	1963840000

Note	
------	--

Note	
------	--

Note	
------	--

V4 junction boxes

V4 junction boxes

- IP 67
- For wall or floor mounting

Double junction box

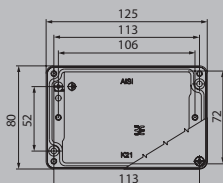

Single junction box

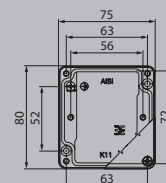

Technical data

Protection degree
Housing main material
Colour
Type of mounting
Ambient temperature (operational)
Plugging cycles
Connector standard
Sheath diameter min. / max.
Approvals

IP 67
Al - Si 12
Grey
Floor-mounted, Wall mounting
-40 °C...70 °C
750
IEC 61076-3-106 Var. 4
5 mm / 10 mm
GOSTME25

IP 67
Al - Si 12
Grey
Floor-mounted, Wall mounting
-40 °C...70 °C
750
IEC 61076-3-106 Var. 4
5 mm / 10 mm

Note

Ordering data

Variant 4

Type	Qty.	Order No.
IE-OM-V04P-K21-2S	1	1966250000

Type	Qty.	Order No.
IE-OM-V04P-K11-1S	1	1966220000

Note

RJ45 modules can be ordered separately

RJ45 modules can be ordered separately

Accessories

Inserts, Data



RJ45 module EIA/TIA T568 B
RJ45 module PROFINET
RJ45 module EIA/TIA T568 A

Type	Qty.	Order No.
IE-BI-RJ45-FJ-B	10	1963840000
IE-BI-RJ45-FJ-P	10	1963830000
IE-BI-RJ45-FJ-A	10	1962850000

Type	Qty.	Order No.
IE-BI-RJ45-FJ-B	10	1963840000
IE-BI-RJ45-FJ-P	10	1963830000
IE-BI-RJ45-FJ-A	10	1962850000

Note

V5 junction boxes

- IP 67
- For wall or floor mounting

Double junction box

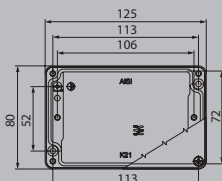

Single junction box

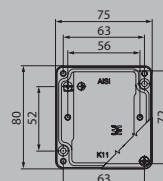
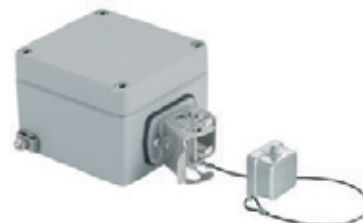

Technical data

Protection degree
Housing main material
Colour
Type of mounting
Ambient temperature (operational)
Plugging cycles
Connector standard
Sheath diameter min. / max.
Approvals

IP 67
Al - Si 12
Grey
Floor-mounted, Wall mounting
-40 °C...70 °C
750
IEC 61076-3-106 Var. 5
5 mm / 10 mm
GOSTME25

IP 67
Al - Si 12
Grey
Floor-mounted, Wall mounting
-40 °C...70 °C
750
IEC 61076-3-106 Var. 5
5 mm / 10 mm

Note

Ordering data

Variant 5	
	2 ports. straight
	1 port. straight

Note

Type	Qty.	Order No.
IE-OM-V05M-K21-2S	1	1966290000

RJ45 modules can be ordered separately

Type	Qty.	Order No.
IE-OM-V05M-K11-1S	1	1966260000

RJ45 modules can be ordered separately

Accessories

Inserts, Data	
	RJ45 module EIA/TIA T568 B
	RJ45 module PROFINET
	RJ45 module EIA/TIA T568 A

Type	Qty.	Order No.
IE-BI-RJ45-FJ-B	10	1963840000
IE-BI-RJ45-FJ-P	10	1963830000
IE-BI-RJ45-FJ-A	10	1962850000

Type	Qty.	Order No.
IE-BI-RJ45-FJ-B	10	1963840000
IE-BI-RJ45-FJ-P	10	1963830000
IE-BI-RJ45-FJ-A	10	1962850000

Note

V6 junction boxes

V6 junction boxes

- Cat. 6
- IP 67

Single junction box, RJ45

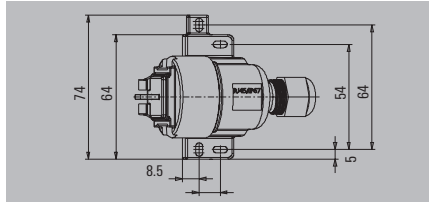

Technical data

Protection degree
Housing main material
Colour
Type of mounting

Configuration

Wiring
Ambient temperature (operational)
Plugging cycles
Connector standard
Sheath diameter min. / max.
Approvals

Note

IP 67
PA 66, UL 94: V-0
Light Grey
Floor-mounted, for exposed connections, Wall mounting

Screw-on junction box
including RJ45 module with
IDC connection

EIA/TIA T568 A, EIA/TIA T568 B
-40 °C...70 °C
750
IEC 61076-3-106 Var. 6
6 mm / 9.5 mm
EAC; GERMILLOYD

Ordering data

Note

Type	Qty.	Order No.
IE-S-IP67	1	8808370000

Accessories

Tools	
	Crimping tool

Type	Qty.	Order No.
TT 8 RS MP 8	1	9202800000

Note

Copper cabling solutions

Overview

Copper cabling solutions	Introduction AdvancedLine and CabinetLine	L.2
	Product configurator – Copper cables	L.3
	Overview – Copper cables	L.4
	Raw cables – Installation cable	L.6
	Raw cables – Connection cable	L.8
	Raw cables – Dragline cable	L.13
	Raw cables – PROFINET cable	L.14
	Raw cables – Hybrid cable	L.16
	Assembled cables – Patch cable	L.17
	Assembled cables – PROFINET cable	L.25
	Assembled cables – PROFINET cable PushPull Power	L.29
	Assembled cables – PROFINET cable M12	L.30
	Assembled cables – EtherNet/IP	L.37
	Assembled cables – Railway cable M12	L.39
	Assembled cables – Railway cable RJ45	L.44
	Assembled cables – USB cable	L.45

The ideal solution, whatever your needs

Our AdvancedLine and CabinetLine product ranges

AdvancedLine



The AdvancedLine from Weidmüller offers all combinations of cables that are possible with the extensive range of plug connections.

This means flexibility and robustness through the high quality of the used components. The range comprises standard cables and customer-specific versions. Standard cables can be found in the catalogue; customer-specific versions can be freely configured online using the "Galaxy" configuration software. All AdvancedLine cables are particularly suitable for industrial use.

- High-quality cables with very good technical characteristics
- Suitable for demanding IP 20 to IP 67 applications
- Suitable for temperatures from -40 to +70 °C
- High-quality shielding

CabinetLine



The new CabinetLine range of patch cables from Weidmüller is available in a variety of colours for visually differentiating between various networks.

Additional benefits:

All CabinetLine cables are fitted with Weidmüller TM marking sleeves for clearly labelling cables and ports. CabinetLine is available in the colours grey, blue, red and violet in combination with LSZH sheathing material and transmission power Cat. 6A. CabinetLine is also available in the colour green and Cat. 5 with PUR or PVC sheathing material. All variants are fitted with protected clips which facilitate, e.g., pulling through a cable duct.

- For applications in switching cabinets and simple environmental conditions
- Suitable for temperatures from 0 to +60 °C
- Simple shielding

Configurators for copper cables

Tailor-made connections

The cable configurator in Weidmüller's online catalogue makes it possible for you to create fully-assembled cables customised specifically to your requirements and specifications.

An RJ45 plug with IP 20 protection is available. The following variants are also available with IP 67 protection:

- Variant 1, metal and plastic
- Variant 4, plastic
- Variant 5, metal
- Variant 14, metal
- M12 connector, straight and angled

You have the choice of configuring a cable which is identical on both ends, or with two different mating profiles, or with one end left open.



When selecting the cable, the following types are available:

- 8-wire system cable, AWG 26/7 in Cat. 5 or Cat. 7, with PVC or PUR sheath
- 8-wire dragline cable, AWG 26/7 in Cat. 5, PUR sheath
- 4-wire PROFINET dragline cable in Cat. 5, PUR sheath
- 4-wire PROFINET system cables in Cat. 5, PVC sheathing
- 4-wire railway cable in Cat. 5, Radox sheathing

The cable length can also be customised:

- From 0.3 m to 9.9 m, in 0.1 m steps
- From 10 m to 100 m, in 1 m steps

The cable configurator can automatically create technical data sheets for all of your customised cable variants.

All of your cable selections can be sent to Weidmüller using the "request list". You will then quickly receive a price proposal for the cables from your local Weidmüller representative.

Overview of copper cables

Solutions for every environment

Copper cables should be your first choice for applications in offices and harsh industrial environments.

Advantages:

- Available in many different variations and lengths
- Robust
- Easy to assemble
- RJ45 connections are the most popular

Raw cables / Metre goods

Industrial installation cables, horizontal cables



...for stationary, permanent installation in cable ducts and cable trays

- Cat. 5 or Cat. 7
- Available for PROFINET as well
- With PUR or PVC sheathing

Industrial connecting cables



...for flexible installation in machines and plants in industrial applications and difficult environments

- Cat. 5 or Cat. 7
- Available for PROFINET as well
- With PUR or PVC sheathing

Industrial trailing cables



...for applications subjected to constant movement

- Cat. 5
- Available for PROFINET as well
- With PUR sheathing

Assembled cables

Industrial patch cables / CabinetLine



...not only for office applications, but also in switching cabinets for industrial applications

- Cat. 6
- With LSZH sheathing – low smoke and zero halogens
- In straight and crossover versions

Industrial system cables



...pre-assembled cables for flexible installation in machines and plants in industrial applications and difficult environments

- Cat. 5 or Cat. 6
- With PUR sheathing

Industrial trailing cables



...pre-assembled cable for constant motion, e.g., with draglines

- Cat. 5
- Available for PROFINET as well
- With PUR sheathing

System cable for railway applications



...pre-assembled cable for flexible wiring on railway vehicles for both interior and exterior installations.

- In Cat. 5
- Also for PROFINET
- With Radox sheath

Ordering data for copper cables, metre goods

Type	Cat./Class	Colour	Plug-in connector		Length					
			left	right	100 m	Metre goods	305 m			
Industrial installation cables										
IE-51C4x2xAWG24/1-PUR	Cat. 5	green	-	-	8813160000	8944310000				
IE-51C4x2xAWG24/1-PVC	Cat. 5	green	-	-	8813150000	8953160000				
IE-71C4x2xAWG23/1-PUR	Cat. 7	green	-	-	8813140000	8955350000				
IE-71C4x2xAWG23/1-PVC	Cat. 7	green	-	-	8813130000	8955360000				
IE-C5AS4Vxx	Cat. 5 PROFINET	green	-	-	8899000000	8955950000				
Industrial connecting cables										
IE-5CC4x2xAWG26/7-PUR	Cat. 5	green	-	-	8813200000	8938880000				
IE-5CC4x2xAWG26/7-PVC	Cat. 5	green	-	-	8813190000	8955490000				
IE-7CC4x2xAWG26/7-PUR	Cat. 7	green	-	-	8813180000	8954300000				
IE-7CC4x2xAWG26/7-PVC	Cat. 7	green	-	-	8813170000	8955480000				
IE-C5DS4Vxx	Cat. 5 PROFINET	green	-	-	8898990000	8955560000				
IE-C5DHAGxx	Cat. 5 PROFINET	green	-	-		1172250000				
IE-C7FS8LD-305M	Cat. 7	grey	-	-			1273090000			
IE-C7FS8LB-305M	Cat. 7	blue	-	-			1326540000			
IE-C7FS8LE-305M	Cat. 7	black	-	-			1344690000			
IE-C7FS8LG-305M	Cat. 7	green	-	-			1344680000			
IE-C7FS8LR-305M	Cat. 7	red	-	-			1287910000			
IE-C7FS8LM-305M	Cat. 7	magenta	-	-			1333160000			
IE-C7FS8LY-305M	Cat. 7	yellow	-	-			1344670000			
Industrial trailing cables										
IE-5TC4x2xAWG26/7-PUR	Cat. 5	green	-	-	8813210000	8936390000				
IE-C5ED8UBxx	Cat. 5	blue	-	-	8960670000	8949760000				
IE-C5DD4UGx	Cat. 5 PROFINET	green	-	-	8899010000	8947670000				
IE-C5IT4UGx	Cat. 5 PROFINET	green	-	-		1103010000				

Raw cables – Installation cable

Raw cables

Installation cable Cat. 5

- In lengths from 100 to 1000 metres

PUR

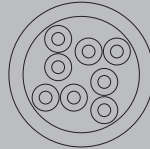

PVC

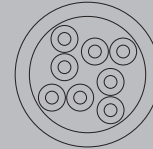

Technical data

Product type
Category
Shielding
Cross-section
Sheath diameter, max.
Material sheath
Sheathing colour
Insulation diameter
Min. bending radius, repetitive
Min. bending radius, once only
Ambient temperature (operational)
Installation temperature
Storage temperature
Abrasion resistance
Halogen
Resistance to spread of flame
Resistance to oils
Approvals

Note

Installation cable
Cat.5 (ISO/IEC 11801) / Cat.5e (TIA T568-B)
SF/UTP
4*2*AWG 24/1 - 4*2*0.205 mm ²
6.7 mm
PUR
green (RAL 6018)
1 mm
10 *diameter
5 *diameter
-40 °C...80 °C
-15 °C...60 °C
-40 °C...80 °C
very good
halogen-free, according to IEC 60754-2
in accordance with IEC 60332-1
in accordance with IEC 60811-2-1

Installation cable
Cat.5 (ISO/IEC 11801) / Cat.5e (TIA T568-B)
SF/UTP
4*2*AWG 24/1 - 4*2*0.205 mm ²
6.3 mm
PVC
green (RAL 6018)
1 mm
10 *diameter
5 *diameter
-40 °C...80 °C
-15 °C...60 °C
-40 °C...80 °C
good
in accordance with IEC 60332-1

Ordering data

100.0 m
Cut to metre starting at 110.0 m

Note

Type	Qty.	Order No.
IE-5IC4x2xAWG24/1-PUR	1	8813160000
IE-C5CS8UG-MW		8944310000

Order example, for cut cable: 150 x „article number“ = 150 m on drum

Type	Qty.	Order No.
IE-5IC4x2xAWG24/1-PVC	1	8813150000
IE-C5CS8VG-MW		8953160000

Order example, for cut cable: 150 x „article number“ = 150 m on drum

Accessories

Sheathing stripper
For UTP and STP data cables
For coaxial and round data cables

Markers

Wire and cable marker. ø 4.7 - 7.4 mm
Wire and cable marker. ø 5.8 - 7.8 mm
Insertion label. yellow. 12 mm
Insertion label. yellow. 18 mm
Transparent sleeves. 12-mm length
Transparent sleeves. 18-mm length

Type	Qty.	Order No.
AM 12	1	9030060000
IE-CST	1	9204350000

VT SF 5/21 MC NE WS VO	160	1689470001
VT SF 6/21 MC NE WS VO	160	1730560001
TM-I 12 MC NE GE	320	1718411687
TM-I 18 MC NE GE	320	1718431687
TM 4/12 HF/HB	500	1719840000
TM 4/18 HF/HB	500	1719850000

Type	Qty.	Order No.
AM 12	1	9030060000
IE-CST	1	9204350000

VT SF 5/21 MC NE WS VO	160	1689470001
VT SF 6/21 MC NE WS VO	160	1730560001
TM-I 12 MC NE GE	320	1718411687
TM-I 18 MC NE GE	320	1718431687
TM 4/12 HF/HB	500	1719840000
TM 4/18 HF/HB	500	1719850000

Note

Raw cables

Installation cable Cat. 7

- In lengths from 100 to 1000 metres

PUR

PVC

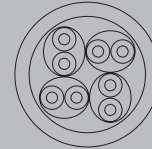
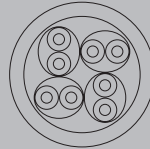

Technical data

Product type	Installation cable
Category	Cat.7 (ISO/IEC 11801)
Shielding	S/FTP
Cross-section	4*2*AWG 23/1 - 4*2*0.255 mm ²
Sheath diameter, max.	8.4 mm
Material sheath	PUR
Sheathing colour	green (RAL 6018)
Insulation diameter	1.4 mm
Min. bending radius, repetitive	10 *diameter
Min. bending radius, once only	5 *diameter
Ambient temperature (operational)	-40 °C...80 °C
Installation temperature	-15 °C...60 °C
Storage temperature	-40 °C...80 °C
Abrasion resistance	very good
Halogen	halogen-free, according to IEC 60754-2
Resistance to spread of flame	in accordance with IEC 60332-1
Resistance to oils	in accordance with IEC 60811-2-1
Approvals	
Note	

Product type	Installation cable
Category	Cat.7 (ISO/IEC 11801)
Shielding	S/FTP
Cross-section	4*2*AWG 23/1 - 4*2*0.255 mm ²
Sheath diameter, max.	8.4 mm
Material sheath	PVC
Sheathing colour	green (RAL 6018)
Insulation diameter	1.4 mm
Min. bending radius, repetitive	10 *diameter
Min. bending radius, once only	5 *diameter
Ambient temperature (operational)	-40 °C...80 °C
Installation temperature	-15 °C...60 °C
Storage temperature	-40 °C...80 °C
Abrasion resistance	good
Halogen	
Resistance to spread of flame	in accordance with IEC 60332-1
Resistance to oils	
Approvals	
Note	

Product type	Installation cable
Category	Cat.7 (ISO/IEC 11801)
Shielding	S/FTP
Cross-section	4*2*AWG 23/1 - 4*2*0.255 mm ²
Sheath diameter, max.	8.4 mm
Material sheath	PVC
Sheathing colour	green (RAL 6018)
Insulation diameter	1.4 mm
Min. bending radius, repetitive	10 *diameter
Min. bending radius, once only	5 *diameter
Ambient temperature (operational)	-40 °C...80 °C
Installation temperature	-15 °C...60 °C
Storage temperature	-40 °C...80 °C
Abrasion resistance	good
Halogen	
Resistance to spread of flame	in accordance with IEC 60332-1
Resistance to oils	
Approvals	
Note	

Ordering data

100.0 m
Cut to metre starting at 110.0 m
Note

Type	Qty.	Order No.
IE-7IC4x2xAWG23/1-PUR	1	8813140000
IE-C7BS8UG-MW		8955350000
Order example, for cut cable: 150 x „article number“ = 150 m on drum		

Type	Qty.	Order No.
IE-7IC4x2xAWG23/1-PVC	1	8813130000
IE-C7BS8VG-MW		8955360000
Order example, for cut cable: 150 x „article number“ = 150 m on drum		

Accessories

Sheathing stripper	
	For UTP and STP data cables
	For coaxial and round data cables
Markers	
	Wire and cable marker. ø 4.7 - 7.4 mm
	Wire and cable marker. ø 5.8 - 7.8 mm
	Insertion label. yellow. 12 mm
	Insertion label. yellow. 18 mm
	Transparent sleeves. 12-mm length
	Transparent sleeves. 18-mm length

Type	Qty.	Order No.
AM 12	1	9030060000
IE-CST	1	9204350000
VT SF 5/21 MC NE WS VO	160	1689470001
VT SF 6/21 MC NE WS VO	160	1730560001
TM-H 12 MC NE GE	320	1718411687
TM-H 18 MC NE GE	320	1718431687
TM 4/12 HF/HB	500	1719840000
TM 4/18 HF/HB	500	1719850000

Type	Qty.	Order No.
AM 12	1	9030060000
IE-CST	1	9204350000
VT SF 5/21 MC NE WS VO	160	1689470001
VT SF 6/21 MC NE WS VO	160	1730560001
TM-H 12 MC NE GE	320	1718411687
TM-H 18 MC NE GE	320	1718431687
TM 4/12 HF/HB	500	1719840000
TM 4/18 HF/HB	500	1719850000

Note

Note

Note

Raw cables – Connection cable

Raw cables

Connecting cable Cat. 5

- In lengths from 100 to 1000 metres

PUR

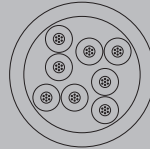

PVC

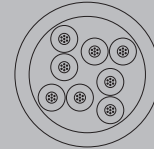

Technical data

Product type
Category
Shielding
Cross-section
Sheath diameter, max.
Material sheath
Sheathing colour
Insulation diameter
Min. bending radius, repetitive
Min. bending radius, once only
Ambient temperature (operational)
Installation temperature
Storage temperature
Abrasion resistance
Halogen
Resistance to spread of flame
Resistance to oils
Standard, assembly
Approvals

Note

System cable
Cat.5 (ISO/IEC 11801) / Cat.5e (TIA T568-B)
SF/UTP
4*2*AWG 26/7 - 4*2*0.128 mm ²
6.1 mm
PUR
green (RAL 6018)
1 mm
10 *diameter
5 *diameter
-40 °C...80 °C
-10 °C...60 °C
-40 °C...80 °C
very good
halogen-free, according to IEC 60754-2
in accordance with IEC 60332-1
in accordance with IEC 60811-2-1
UL-Style 20963 (80°C/30V)

System cable
Cat.5 (ISO/IEC 11801) / Cat.5e (TIA T568-B)
SF/UTP
4*2*AWG 26/7 - 4*2*0.128 mm ²
5.8 mm
PVC
green (RAL 6018)
1 mm
10 *diameter
5 *diameter
-40 °C...80 °C
-15 °C...60 °C
-40 °C...80 °C
good

in accordance with IEC 60332-1

Ordering data

100.0 m
Cut to metre starting at 110.0 m

Note

Type	Qty.	Order No.
IE-5CC4x2xAWG26/7-PUR	1	8813200000
IE-C5ES8UG-MW		8938880000

Order example, for cut cable: 150 x „article number“ = 150 m on drum

Type	Qty.	Order No.
IE-5CC4x2xAWG26/7-PVC	1	8813190000
IE-C5ES8VG-MW		8955490000

Order example, for cut cable: 150 x „article number“ = 150 m on drum

Accessories

Sheathing stripper
For UTP and STP data cables
For coaxial and round data cables

Markers
Wire and cable marker. ø 4.7 - 7.4 mm
Wire and cable marker. ø 5.8 - 7.8 mm
Insertion label. yellow. 12 mm
Insertion label. yellow. 18 mm
Transparent sleeves. 12-mm length
Transparent sleeves. 18-mm length

Type	Qty.	Order No.
AM 12	1	9030060000
IE-CST	1	9204350000
VT SF 5/21 MC NE WS VO	160	1689470001
VT SF 6/21 MC NE WS VO	160	1730560001
TM-H 12 MC NE GE	320	1718411687
TM-H 18 MC NE GE	320	1718431687
TM 4/12 HF/HB	500	1719840000
TM 4/18 HF/HB	500	1719850000

Type	Qty.	Order No.
AM 12	1	9030060000
IE-CST	1	9204350000
VT SF 5/21 MC NE WS VO	160	1689470001
VT SF 6/21 MC NE WS VO	160	1730560001
TM-H 12 MC NE GE	320	1718411687
TM-H 18 MC NE GE	320	1718431687
TM 4/12 HF/HB	500	1719840000
TM 4/18 HF/HB	500	1719850000

Note

Raw cables

Connecting cable Cat. 7

- In lengths from 100 to 1000 metres

PUR

PVC

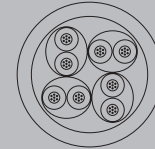
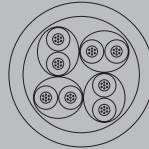

Technical data

Product type	System cable
Category	Cat.7 (ISO/IEC 11801)
Shielding	S/FTP
Cross-section	4*2*AWG 26/7 - 4*2*0.128 mm ²
Sheath diameter, max.	6.6 mm
Material sheath	PUR
Sheathing colour	green (RAL 6018)
Insulation diameter	1.03 mm
Min. bending radius, repetitive	10 *diameter
Min. bending radius, once only	5 *diameter
Ambient temperature (operational)	-40 °C...80 °C
Installation temperature	-15 °C...60 °C
Storage temperature	-40 °C...80 °C
Abrasion resistance	very good
Halogen	halogen-free, according to IEC 60754-2
Resistance to spread of flame	in accordance with IEC 60332-1
Resistance to oils	in accordance with IEC 60811-2-1
Standard, assembly	UL-Style 20963 (80°C/30V)

Product type	System cable
Category	Cat.7 (ISO/IEC 11801)
Shielding	S/FTP
Cross-section	4*2*AWG 26/7 - 4*2*0.128 mm ²
Sheath diameter, max.	6.7 mm
Material sheath	PVC
Sheathing colour	green (RAL 6018)
Insulation diameter	0.98 mm
Min. bending radius, repetitive	10 *diameter
Min. bending radius, once only	5 *diameter
Ambient temperature (operational)	-40 °C...80 °C
Installation temperature	-15 °C...60 °C
Storage temperature	-40 °C...80 °C
Abrasion resistance	good
Halogen	in accordance with IEC 60332-1
Resistance to spread of flame	in accordance with IEC 60332-1
Resistance to oils	in accordance with IEC 60811-2-1
Standard, assembly	UL-Style 2879 (80°C/30V)

Product type	System cable
Category	Cat.7 (ISO/IEC 11801)
Shielding	S/FTP
Cross-section	4*2*AWG 26/7 - 4*2*0.128 mm ²
Sheath diameter, max.	6.7 mm
Material sheath	PVC
Sheathing colour	green (RAL 6018)
Insulation diameter	0.98 mm
Min. bending radius, repetitive	10 *diameter
Min. bending radius, once only	5 *diameter
Ambient temperature (operational)	-40 °C...80 °C
Installation temperature	-15 °C...60 °C
Storage temperature	-40 °C...80 °C
Abrasion resistance	good
Halogen	in accordance with IEC 60332-1
Resistance to spread of flame	in accordance with IEC 60332-1
Resistance to oils	in accordance with IEC 60811-2-1
Standard, assembly	UL-Style 2879 (80°C/30V)

Note

Note

Note

Ordering data

100.0 m
Cut to metre starting at 110.0 m

Type	Qty.	Order No.
IE-7CC4x2xAWG26/7-PUR	1	8813180000
IE-C7ES8UG-MW		8954300000

Order example, for cut cable: 150 x „article number“ = 150 m on drum

Type	Qty.	Order No.
IE-7CC4x2xAWG26/7-PVC	1	8813170000
IE-C7ES8VG-MW		8955480000

Order example, for cut cable: 150 x „article number“ = 150 m on drum

Note

Accessories

Sheathing stripper
For UTP and STP data cables
For coaxial and round data cables

Markers
Wire and cable marker. ø 4.7 - 7.4 mm
Wire and cable marker. ø 5.8 - 7.8 mm
Insertion label. yellow. 12 mm
Insertion label. yellow. 18 mm
Transparent sleeves. 12-mm length
Transparent sleeves. 18-mm length

Type	Qty.	Order No.
AM 12	1	9030060000
IE-CST	1	9204350000
VT SF 5/21 MC NE WS VO	160	1689470001
VT SF 6/21 MC NE WS VO	160	1730560001
TM-H 12 MC NE GE	320	1718411687
TM-H 18 MC NE GE	320	1718431687
TM 4/12 HF/HB	500	1719840000
TM 4/18 HF/HB	500	1719850000

Type	Qty.	Order No.
AM 12	1	9030060000
IE-CST	1	9204350000
VT SF 5/21 MC NE WS VO	160	1689470001
VT SF 6/21 MC NE WS VO	160	1730560001
TM-H 12 MC NE GE	320	1718411687
TM-H 18 MC NE GE	320	1718431687
TM 4/12 HF/HB	500	1719840000
TM 4/18 HF/HB	500	1719850000

Note

Note

Note

Raw cables – Connection cable

Raw cables

Connecting cable Cat. 7

- 305 m / 1,000 ft

LSZH grey

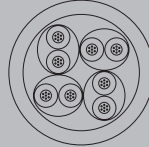

LSZH blue

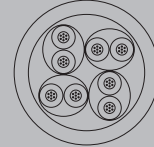

Technical data

Product type
Category
Shielding
Cross-section
Sheath diameter, max.
Material sheath
Sheathing colour
Insulation diameter
Min. bending radius, repetitive
Min. bending radius, once only
Ambient temperature (operational)
Installation temperature
Halogen
Resistance to spread of flame
Resistance to oils
Approvals

Note

System cable
Cat.7 (ISO/IEC 11801)
S/FTP
4*2*AWG 27/7 - 4*2*0.1 mm ²
5.9 mm
LSZH
light grey (RAL 7035)
1.04 mm
50 mm
25 mm
-20 °C...60 °C
0 °C...50 °C
No
in accordance with IEC 60332-1

CULUS

System cable
Cat.7 (ISO/IEC 11801)
S/FTP
4*2*AWG 27/7 - 4*2*0.1 mm ²
5.9 mm
LSZH
blue (RAL 5015)
1.04 mm
50 mm
25 mm
-20 °C...60 °C
0 °C...50 °C
No
in accordance with IEC 60332-1

CULUS

Ordering data

305 m / 1000 ft

Note

Type	Qty.	Order No.
IE-C7FS8LD-305M	1	1273090000

Type	Qty.	Order No.
IE-C7FS8LB-305M	1	1326540000

Accessories

Sheathing stripper

For UTP and STP data cables
For coaxial and round data cables

Markers

Wire and cable marker. ø 4.7 - 7.4 mm
Wire and cable marker. ø 5.8 - 7.8 mm
Insertion label, yellow. 12 mm
Insertion label, yellow. 18 mm
Transparent sleeves. 12-mm length
Transparent sleeves. 18-mm length

Type	Qty.	Order No.
AM 12	1	9030060000
IE-CST	1	9204350000

VT SF 5/21 MC NE WS VO	160	1689470001
VT SF 6/21 MC NE WS VO	160	1730560001
TM-H 12 MC NE GE	320	1718411687
TM-H 18 MC NE GE	320	1718431687
TM 4/12 HF/HB	500	1719840000
TM 4/18 HF/HB	500	1719850000

Type	Qty.	Order No.
AM 12	1	9030060000
IE-CST	1	9204350000

VT SF 5/21 MC NE WS VO	160	1689470001
VT SF 6/21 MC NE WS VO	160	1730560001
TM-H 12 MC NE GE	320	1718411687
TM-H 18 MC NE GE	320	1718431687
TM 4/12 HF/HB	500	1719840000
TM 4/18 HF/HB	500	1719850000

Note

LSZH black

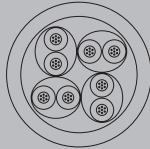

System cable
Cat.7 (ISO/IEC 11801)
S/FTP
4*2*AWG 27/7 - 4*2*0.1 mm²
5.9 mm
LSZH
Black
1.04 mm
50 mm
25 mm
-20 °C...60 °C
0 °C...50 °C
No
in accordance with IEC 60332-1

CULUS

Type	Qty.	Order No.
IE-C7FS8LE-305M	1	1344690000

Type	Qty.	Order No.
AM 12	1	9030060000
IE-CST	1	9204350000
VT SF 5/21 MC NE WS VO	160	1689470001
VT SF 6/21 MC NE WS VO	160	1730560001
TMH 12 MC NE GE	320	1718411687
TMH 18 MC NE GE	320	1718431687
TM 4/12 HF/HB	500	1719840000
TM 4/18 HF/HB	500	1719850000

LSZH green

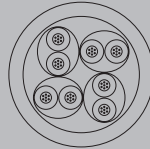

System cable
Cat.7 (ISO/IEC 11801)
S/FTP
4*2*AWG 27/7 - 4*2*0.1 mm²
5.9 mm
LSZH
Green
1.04 mm
50 mm
25 mm
-20 °C...60 °C
0 °C...50 °C
No
in accordance with IEC 60332-1

CULUS

Type	Qty.	Order No.
IE-C7FS8LG-305M	1	1344680000

Type	Qty.	Order No.
AM 12	1	9030060000
IE-CST	1	9204350000
VT SF 5/21 MC NE WS VO	160	1689470001
VT SF 6/21 MC NE WS VO	160	1730560001
TMH 12 MC NE GE	320	1718411687
TMH 18 MC NE GE	320	1718431687
TM 4/12 HF/HB	500	1719840000
TM 4/18 HF/HB	500	1719850000

LSZH red

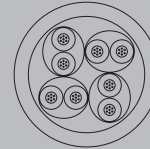

System cable
Cat.7 (ISO/IEC 11801)
S/FTP
4*2*AWG 27/7 - 4*2*0.1 mm²
5.9 mm
LSZH
Red
1.04 mm
50 mm
25 mm
-20 °C...60 °C
0 °C...50 °C
No
in accordance with IEC 60332-1

CULUS

Type	Qty.	Order No.
IE-C7FS8LR-305M	1	1287910000

Type	Qty.	Order No.
AM 12	1	9030060000
IE-CST	1	9204350000
VT SF 5/21 MC NE WS VO	160	1689470001
VT SF 6/21 MC NE WS VO	160	1730560001
TMH 12 MC NE GE	320	1718411687
TMH 18 MC NE GE	320	1718431687
TM 4/12 HF/HB	500	1719840000
TM 4/18 HF/HB	500	1719850000

Raw cables – Connection cable

Raw cables

Connecting cable Cat. 7

- 305 m / 1,000 ft

LSZH magenta

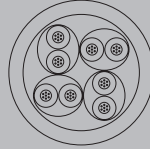

LSZH yellow

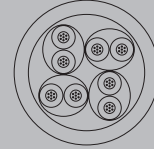

Technical data

Product type
Category
Shielding
Cross-section
Sheath diameter, max.
Material sheath
Sheathing colour
Insulation diameter
Min. bending radius, repetitive
Min. bending radius, once only
Ambient temperature (operational)
Installation temperature
Halogen
Resistance to spread of flame
Resistance to oils
Approvals

Note

System cable
Cat.7 (ISO/IEC 11801)
S/FTP
4*2*AWG 27/7 - 4*2*0.1 mm ²
5.9 mm
LSZH
Magenta
1.04 mm
50 mm
25 mm
-20 °C...60 °C
0 °C...50 °C
No
in accordance with IEC 60332-1

CULUS

System cable
Cat.7 (ISO/IEC 11801)
S/FTP
4*2*AWG 27/7 - 4*2*0.1 mm ²
5.9 mm
LSZH
Yellow
1.04 mm
50 mm
25 mm
-20 °C...60 °C
0 °C...50 °C
No
in accordance with IEC 60332-1

CULUS

Ordering data

305 m / 1000 ft

Note

Type	Qty.	Order No.
IE-C7FS8LM-305M	1	1333160000

Type	Qty.	Order No.
IE-C7FS8LY-305M	1	1344670000

Accessories

Sheathing stripper

For UTP and STP data cables
For coaxial and round data cables

Markers

Insertion label, yellow, 12 mm
Insertion label, yellow, 18 mm
Transparent sleeves, 12-mm length
Transparent sleeves, 18-mm length
Wire and cable marker, ø 4.7 - 7.4 mm
Wire and cable marker, ø 5.8 - 7.8 mm

Type	Qty.	Order No.
AM 12	1	9030060000
IE-CST	1	9204350000

TM-I 12 MC NE GE	320	1718411687
TM-I 18 MC NE GE	320	1718431687
TM 4/12 HF/HB	500	1719840000
TM 4/18 HF/HB	500	1719850000
VT SF 5/21 MC NE WS VO	160	1689470001
VT SF 6/21 MC NE WS VO	160	1730560001

Type	Qty.	Order No.
AM 12	1	9030060000
IE-CST	1	9204350000

TM-I 12 MC NE GE	320	1718411687
TM-I 18 MC NE GE	320	1718431687
TM 4/12 HF/HB	500	1719840000
TM 4/18 HF/HB	500	1719850000
VT SF 5/21 MC NE WS VO	160	1689470001
VT SF 6/21 MC NE WS VO	160	1730560001

Note

Raw cables

Dragline cable Cat. 5

- In lengths from 100 to 1000 metres

PUR green

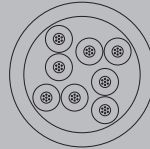

PUR blue

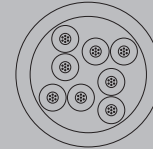

Technical data

Product type	Dragline cable
Category	Cat.5 (ISO/IEC 11801) / Cat.5e (TIA T568-B)
Shielding	SF/UTP
Cross-section	4*2*AWG 26/7 - 4*2*0.128 mm ²
Sheath diameter, max.	6.8 mm
Material sheath	PUR
Sheathing colour	green (RAL 6018)
Insulation diameter	0.95 mm
Min. bending radius, repetitive	7.5 *diameter
Min. bending radius, once only	4 *diameter
Bending cycles	5 Mio
Ambient temperature (operational)	-40 °C...80 °C
Installation temperature	-20 °C...60 °C
Storage temperature	-40 °C...80 °C
Abrasion resistance	very good
Halogen	halogen-free, according to IEC 60754-2
Resistance to spread of flame	in accordance with IEC 60332-1
Resistance to oils	in accordance with IEC 60811-2-1
Standard, assembly	UL-Style 20963 (80°C/30V)
Approvals	

Product type	Dragline cable
Category	Cat.5 (ISO/IEC 11801) / Cat.5e (TIA T568-B)
Shielding	SF/UTP
Cross-section	4*2*AWG 26/7 - 4*2*0.128 mm ²
Sheath diameter, max.	6.8 mm
Material sheath	PUR
Sheathing colour	blue (RAL 5015)
Insulation diameter	0.95 mm
Min. bending radius, repetitive	7.5 *diameter
Min. bending radius, once only	4 *diameter
Bending cycles	5 Mio
Ambient temperature (operational)	-40 °C...80 °C
Installation temperature	-20 °C...60 °C
Storage temperature	-40 °C...80 °C
Abrasion resistance	very good
Halogen	halogen-free, according to IEC 60754-2
Resistance to spread of flame	in accordance with IEC 60332-1
Resistance to oils	in accordance with IEC 60811-2-1
Standard, assembly	UL-Style 20963 (80°C/30V)
Approvals	

Product type	Dragline cable
Category	Cat.5 (ISO/IEC 11801) / Cat.5e (TIA T568-B)
Shielding	SF/UTP
Cross-section	4*2*AWG 26/7 - 4*2*0.128 mm ²
Sheath diameter, max.	6.8 mm
Material sheath	PUR
Sheathing colour	blue (RAL 5015)
Insulation diameter	0.95 mm
Min. bending radius, repetitive	7.5 *diameter
Min. bending radius, once only	4 *diameter
Bending cycles	5 Mio
Ambient temperature (operational)	-40 °C...80 °C
Installation temperature	-20 °C...60 °C
Storage temperature	-40 °C...80 °C
Abrasion resistance	very good
Halogen	halogen-free, according to IEC 60754-2
Resistance to spread of flame	in accordance with IEC 60332-1
Resistance to oils	in accordance with IEC 60811-2-1
Standard, assembly	UL-Style 20963 (80°C/30V)
Approvals	

Note

Ordering data

100.0 m
Cut to metre starting at 110.0 m

Note

Type	Qty.	Order No.
IE-5TC4x2xAWG26/7-PUR	1	8813210000
IE-C5ED8UG-MW		8936390000

Order example, for cut cable: 150 x „article number“ = 150 m on drum

Type	Qty.	Order No.
IE-C5ED8UB-100M	1	8960670000
IE-C5ED8UB-MW		8949760000

Order example, for cut cable: 150 x „article number“ = 150 m on drum

Accessories

Sheathing stripper

For UTP and STP data cables
For coaxial and round data cables

Markers

Wire and cable marker. ø 4.7 - 7.4 mm
Wire and cable marker. ø 5.8 - 7.8 mm
Insertion label. yellow. 12 mm
Insertion label. yellow. 18 mm
Transparent sleeves. 12-mm length
Transparent sleeves. 18-mm length

Type	Qty.	Order No.
AM 12	1	9030060000
IE-CST	1	9204350000

VT SF 5/21 MC NE WS VO	160	1689470001
VT SF 6/21 MC NE WS VO	160	1730560001
TM-H 12 MC NE GE	320	1718411687
TM-H 18 MC NE GE	320	1718431687
TM 4/12 HF/HB	500	1719840000
TM 4/18 HF/HB	500	1719850000

Type	Qty.	Order No.
AM 12	1	9030060000
IE-CST	1	9204350000

VT SF 5/21 MC NE WS VO	160	1689470001
VT SF 6/21 MC NE WS VO	160	1730560001
TM-H 12 MC NE GE	320	1718411687
TM-H 18 MC NE GE	320	1718431687
TM 4/12 HF/HB	500	1719840000
TM 4/18 HF/HB	500	1719850000

Note

Raw cables – PROFINET cable

Raw cables

PROFINET cable

- In lengths from 100 to 1000 metres

Installation cable type A, PVC

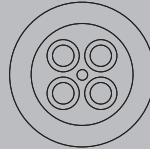

Connection cable type B, PVC

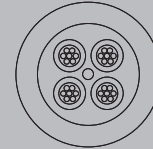

Technical data

Product type
Category
Shielding
Cross-section
Sheath diameter, max.
Material sheath
Sheathing colour
Insulation diameter
Min. bending radius, repetitive
Min. bending radius, once only
Ambient temperature (operational)
Installation temperature
Storage temperature
Abrasion resistance
Resistance to spread of flame
Standard, assembly
Approvals

Note

Installation cable
Cat.5 (ISO/IEC 11801) / Cat.5e (TIA T568-B)
SF/UTP
4*AWG 22/1 - 0.33 mm ²
6.7 mm
PVC
green (RAL 6018)
1.5 mm
7.5 *diameter
3.5 *diameter
-40 °C...75 °C
-20 °C...60 °C
-40 °C...75 °C
good
in accordance with IEC 60332-1 / UL 1685
UL-Style 21694

System cable
Cat.5 (ISO/IEC 11801) / Cat.5e (TIA T568-B)
SF/UTP
4*AWG 22/7 - 0.36 mm ²
6.7 mm
PVC
green (RAL 6018)
1.5 mm
7.5 *diameter
3.5 *diameter
-40 °C...70 °C
-20 °C...60 °C
-40 °C...70 °C
good
in accordance with IEC 60332-1 / UL 1685
UL-Style 21694

Ordering data

100.0 m

Cut to metre starting at 110.0 m

Note

Type	Qty.	Order No.
IE-C5AS4V1000	1	8899000000
IE-C5AS4VG-MW		8955950000

Order example, for cut cable: 150 x „article number“ = 150 m on drum

Type	Qty.	Order No.
IE-C5DS4V1000	1	8898990000
IE-C5DS4VG-MW		8955560000

Order example, for cut cable: 150 x „article number“ = 150 m on drum

Accessories

Sheathing stripper
For UTP and STP data cables
For coaxial and round data cables

Markers
Wire and cable marker. ø 4.7 - 7.4 mm
Wire and cable marker. ø 5.8 - 7.8 mm
Insertion label. yellow. 12 mm
Insertion label. yellow. 18 mm
Transparent sleeves. 12-mm length
Transparent sleeves. 18-mm length

Type	Qty.	Order No.
AM 12	1	9030060000
IE-CST	1	9204350000
VT SF 5/21 MC NE WS VO	160	1689470001
VT SF 6/21 MC NE WS VO	160	1730560001
TM-I 12 MC NE GE	320	1718411687
TM-I 18 MC NE GE	320	1718431687
TM 4/12 HF/HB	500	1719840000
TM 4/18 HF/HB	500	1719850000

Type	Qty.	Order No.
AM 12	1	9030060000
IE-CST	1	9204350000
VT SF 5/21 MC NE WS VO	160	1689470001
VT SF 6/21 MC NE WS VO	160	1730560001
TM-I 12 MC NE GE	320	1718411687
TM-I 18 MC NE GE	320	1718431687
TM 4/12 HF/HB	500	1719840000
TM 4/18 HF/HB	500	1719850000

Note

Raw cables
PROFINET cable

- In lengths from 100 to 1000 metres

Dragline cable type C, PUR

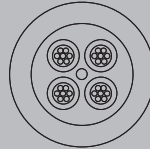

Torsion cable type C, PUR

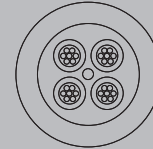

Technical data

Product type
Category
Shielding
Cross-section
Sheath diameter, max.
Material sheath
Sheathing colour
Insulation diameter
Min. bending radius, repetitive
Min. bending radius, once only
Bending cycles
Torsion cycles
Torsion resistance
Ambient temperature (operational)
Installation temperature
Storage temperature
Abrasion resistance
Halogen
Resistance to spread of flame
Resistance to oils
Standard, assembly
Approvals

Note

Dragline cable
Cat.5 (ISO/IEC 11801) / Cat.5e (TIA T568-B)
SF/UTP
4*AWG 22/7 - 0.36 mm ²
6.7 mm
PUR
green (RAL 6018)
1.5 mm
7.5 *diameter
5 *diameter
3 Mio
-40 °C...70 °C
-20 °C...60 °C
-50 °C...70 °C
very good
halogen-free, according to IEC 60754-2
in accordance with IEC 60332-1
in accordance with IEC 60811-2-1

Torsion cable
Cat.5 (ISO/IEC 11801) / Cat.5e (TIA T568-B)
S/UTP
4* AWG 22/19 - 0.38 mm ²
6.7 mm
PUR
green (RAL 6018)
1.5 mm
10 *diameter
5 *diameter
1 mill.
180 °/m
-40 °C...80 °C
-40 °C...80 °C
-40 °C...80 °C
very good
halogen-free, according to IEC 60754-2
in accordance with IEC 60332-1
in accordance with IEC 60811-2-1
UL Style 21161

Ordering data

Cat. 5 PROFINET. PUR
100.0 m
Cut to metre starting at 110.0 m

Note

Type	Qty.	Order No.
IE-C5DD4U1000	1	8899010000
IE-C5DD4UG-MW		8947670000

Order example, for cut cable: 150 x „article number“ = 150 m on drum

Type	Qty.	Order No.
IE-C5IT4UG-MW		1103010000

Order example, for cut cable: 150 x „article number“ = 150 m on drum

Accessories

Sheathing stripper
For UTP and STP data cables
For coaxial and round data cables

Markers

Wire and cable marker. ø 4.7 - 7.4 mm
Wire and cable marker. ø 5.8 - 7.8 mm
Insertion label. yellow. 12 mm
Insertion label. yellow. 18 mm
Transparent sleeves. 12-mm length
Transparent sleeves. 18-mm length

Type	Qty.	Order No.
AM 12	1	9030060000
IE-CST	1	9204350000
VT SF 5/21 MC NE WS VO	160	1689470001
VT SF 6/21 MC NE WS VO	160	1730560001
TM-H 12 MC NE GE	320	1718411687
TM-H 18 MC NE GE	320	1718431687
TM 4/12 HF/HB	500	1719840000
TM 4/18 HF/HB	500	1719850000

Type	Qty.	Order No.
AM 12	1	9030060000
IE-CST	1	9204350000
VT SF 5/21 MC NE WS VO	160	1689470001
VT SF 6/21 MC NE WS VO	160	1730560001
TM-H 12 MC NE GE	320	1718411687
TM-H 18 MC NE GE	320	1718431687
TM 4/12 HF/HB	500	1719840000
TM 4/18 HF/HB	500	1719850000

Note

Raw cables – Hybrid cable

Raw cables

Hybrid cable

- In lengths from 100 to 1000 metres

PVC

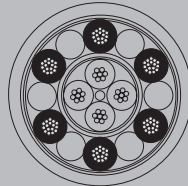

Technical data

Product type
Category
Shielding
Cross-section
Sheath diameter, max.
Material sheath
Sheathing colour
Insulation diameter
Min. bending radius, repetitive
Min. bending radius, once only
Ambient temperature (operational)
Installation temperature
Storage temperature
Abrasion resistance
Halogen
Resistance to spread of flame
Resistance to oils
Standard, assembly
Approvals

Note

Connecting cables
Cat.5 (ISO/IEC 11801) / Cat.5e (TIA T568-B)
SF/UTP
4*AWG 22/7 - 0.36 mm ² , 6*0.5 mm ²
9.5 mm
PVC
green (RAL 6018)
1.5 mm / 1.75 mm
7.5 *diameter
3.5 *diameter
-40 °C...70 °C
-20 °C...60 °C
-40 °C...70 °C
good
Yes
in accordance with IEC 60332-1 / UL 1685
limited

Ordering data

Cut to metre starting at 110.0 m

Note

Type	Qty.	Order No.
IE-C5DHAG-MW		1172250000

Order example, for cut cable: 150 x „article number“ = 150 m on drum

Accessories

Sheathing stripper

For UTP and STP data cables
For coaxial and round data cables

Markers

Wire and cable marker. ø 4.7 - 7.4 mm
Wire and cable marker. ø 5.8 - 7.8 mm
Insertion label. yellow. 12 mm
Insertion label. yellow. 18 mm
Transparent sleeves. 12-mm length
Transparent sleeves. 18-mm length

Type	Qty.	Order No.
AM 12	1	9030060000
IE-CST	1	9204350000
VT SF 5/21 MC NE WS V0	160	1689470001
VT SF 6/21 MC NE WS V0	160	1730560001
TMH 12 MC NE GE	320	1718411687
TMH 18 MC NE GE	320	1718431687
TM 4/12 HF/HB	500	1719840000
TM 4/18 HF/HB	500	1719850000

Note

Assembled cables

Patch cable CabinetLine Cat. 6 straight

LSZH grey



RJ45			RJ45
1	white (orange)	1	RJ45
2	orange	2	
3	white (green)	3	
4	blue	4	
5	white (blue)	5	
6	green	6	
7	white (brown)	7	
8	brown	8	

Technical data

Product type	Patch cable
Category	Cat.6 _A / Class E _A (ISO/IEC 11801 2010)
Shielding	S/FTP
Version connector left / Version connector right	RJ45 IP 20 / RJ45 IP 20
Connector standard	IEC 60603-7-51
PoE / PoE+	conforming to IEEE 802.3at
Cross-section	4*2*AWG 27/7 - 4*2*0.1 mm ²
Sheath diameter, max.	5.9 mm
Material sheath	LSZH
Colour	Grey
Insulation diameter	1.04 mm
Min. bending radius, repetitive	50 mm
Min. bending radius, once only	25 mm
Ambient temperature (operational)	-20 °C...60 °C
Installation temperature	0 °C...50 °C
Storage temperature	-20 °C...60 °C
Halogen	halogen-free, according to IEC 60754-2
Resistance to spread of flame	in accordance with IEC 60332-1 / UL 1581 FT2
Approvals	CULUS

Note

Ordering data

	0.2 m
	0.5 m
	1.0 m
	1.5 m
	2.0 m
	3.0 m
	5.0 m
	7.5 m
	10.0 m
	15.0 m
	20.0 m
	25.0 m

Note

Accessories

Sheathing stripper

For UTP and STP data cables
For coaxial and round data cables

Markers

Insertion label, yellow, 12 mm
Insertion label, yellow, 18 mm

Note

Type	Qty.	Order No.
IE-C6FP8LD0002M40M40-D	1	1165940002
IE-C6FP8LD0005M40M40-D	1	1165940005
IE-C6FP8LD0010M40M40-D	1	1165940010
IE-C6FP8LD0015M40M40-D	1	1165940015
IE-C6FP8LD0020M40M40-D	1	1165940020
IE-C6FP8LD0030M40M40-D	1	1165940030
IE-C6FP8LD0050M40M40-D	1	1165940050
IE-C6FP8LD0075M40M40-D	1	1165940075
IE-C6FP8LD0100M40M40-D	1	1165940100
IE-C6FP8LD0150M40M40-D	1	1165940150
IE-C6FP8LD0200M40M40-D	1	1165940200
IE-C6FP8LD0250M40M40-D	1	1165940250

Other lengths available on request

Type	Qty.	Order No.
AM 12	1	9030060000
IE-CST	1	9204350000
TMH 12 MC NE GE	320	1718411687
TMH 18 MC NE GE	320	1718431687

Assembled cables - Patch cable

Assembled cables

Patch cable CabinetLine Cat. 6 straight

LSZH blue



RJ45				RJ45
1	white (orange)	1		
2	orange	2		
3	white (green)	3		
4	blue	4		
5	white (blue)	5		
6	green	6		
7	white (brown)	7		
8	brown	8		

LSZH black



RJ45				RJ45
1	white (orange)	1		
2	orange	2		
3	white (green)	3		
4	blue	4		
5	white (blue)	5		
6	green	6		
7	white (brown)	7		
8	brown	8		

Technical data

Product type	Patch cable
Category	Cat.6 _A / Class E _A (ISO/IEC 11801 2010)
Shielding	S/FTP
Version connector left / Version connector right	RJ45 IP 20 / RJ45 IP 20
Connector standard	IEC 60603-7-51
PoE / PoE+	conforming to IEEE 802.3at
Cross-section	4*2*AWG 27/7 - 4*2*0.1 mm ²
Sheath diameter, max.	5.9 mm
Material sheath	LSZH
Colour	Blue
Insulation diameter	1.04 mm
Min. bending radius, repetitive	50 mm
Min. bending radius, once only	25 mm
Ambient temperature (operational)	-20 °C...60 °C
Installation temperature	0 °C...50 °C
Storage temperature	-20 °C...60 °C
Halogen	halogen-free, according to IEC 60754-2
Resistance to spread of flame	in accordance with IEC 60332-1 / UL 1581 FT2
Approvals	CULUS
Note	

Product type	Patch cable
Category	Cat.6 _A / Class E _A (ISO/IEC 11801 2010)
Shielding	S/FTP
Version connector left / Version connector right	RJ45 IP 20 / RJ45 IP 20
Connector standard	IEC 60603-7-51
PoE / PoE+	conforming to IEEE 802.3at
Cross-section	4*2*AWG 27/7 - 4*2*0.1 mm ²
Sheath diameter, max.	5.9 mm
Material sheath	LSZH
Colour	Black
Insulation diameter	1.04 mm
Min. bending radius, repetitive	50 mm
Min. bending radius, once only	25 mm
Ambient temperature (operational)	-20 °C...60 °C
Installation temperature	0 °C...50 °C
Storage temperature	-20 °C...60 °C
Halogen	halogen-free, according to IEC 60754-2
Resistance to spread of flame	in accordance with IEC 60332-1 / UL 1581 FT2
Approvals	
Note	

Product type	Patch cable
Category	Cat.6 _A / Class E _A (ISO/IEC 11801 2010)
Shielding	S/FTP
Version connector left / Version connector right	RJ45 IP 20 / RJ45 IP 20
Connector standard	IEC 60603-7-51
PoE / PoE+	conforming to IEEE 802.3at
Cross-section	4*2*AWG 27/7 - 4*2*0.1 mm ²
Sheath diameter, max.	5.9 mm
Material sheath	LSZH
Colour	Black
Insulation diameter	1.04 mm
Min. bending radius, repetitive	50 mm
Min. bending radius, once only	25 mm
Ambient temperature (operational)	-20 °C...60 °C
Installation temperature	0 °C...50 °C
Storage temperature	-20 °C...60 °C
Halogen	halogen-free, according to IEC 60754-2
Resistance to spread of flame	in accordance with IEC 60332-1 / UL 1581 FT2
Approvals	
Note	

Ordering data

	0.2 m
	0.5 m
	1.0 m
	1.5 m
	2.0 m
	3.0 m
	5.0 m
	10.0 m
	15.0 m
	20.0 m
	25.0 m
Note	

Type	Qty.	Order No.
IE-C6FP8LB0002M40M40-B	1	1165900002
IE-C6FP8LB0005M40M40-B	1	1165900005
IE-C6FP8LB0010M40M40-B	1	1165900010
IE-C6FP8LB0015M40M40-B	1	1165900015
IE-C6FP8LB0020M40M40-B	1	1165900020
IE-C6FP8LB0030M40M40-B	1	1165900030
IE-C6FP8LB0050M40M40-B	1	1165900050
IE-C6FP8LB0100M40M40-B	1	1165900100
IE-C6FP8LB0150M40M40-B	1	1165900150
IE-C6FP8LB0200M40M40-B	1	1165900200
IE-C6FP8LB0250M40M40-B	1	1165900250

Type	Qty.	Order No.
IE-C6FP8LE0002M40M40-E	1	1251610002
IE-C6FP8LE0005M40M40-E	1	1251610005
IE-C6FP8LE0010M40M40-E	1	1251610010
IE-C6FP8LE0015M40M40-E	1	1251610015
IE-C6FP8LE0020M40M40-E	1	1251610020
IE-C6FP8LE0030M40M40-E	1	1251610030
IE-C6FP8LE0050M40M40-E	1	1251610050
IE-C6FP8LE0100M40M40-E	1	1251610100
IE-C6FP8LE0150M40M40-E	1	1251610150
IE-C6FP8LE0200M40M40-E	1	1251610200
IE-C6FP8LE0250M40M40-E	1	1251610250

Accessories

Sheathing stripper	
	For UTP and STP data cables
	For coaxial and round data cables
Markers	
	Insertion label, yellow, 12 mm
	Insertion label, yellow, 18 mm
Note	

Type	Qty.	Order No.
AM 12	1	9030060000
IE-CST	1	9204350000
TM-H 12 MC NE GE	320	1718411687
TM-H 18 MC NE GE	320	1718431687

Type	Qty.	Order No.
AM 12	1	9030060000
IE-CST	1	9204350000
TM-H 12 MC NE GE	320	1718411687
TM-H 18 MC NE GE	320	1718431687

Assembled cables

Patch cable CabinetLine Cat. 6 straight

LSZH green



LSZH red



RJ45			RJ45
1	white (orange)	1	RJ45
2	orange	2	
3	white (green)	3	
4	blue	4	
5	white (blue)	5	
6	green	6	
7	white (brown)	7	
8	brown	8	

RJ45			RJ45
1	white (orange)	1	RJ45
2	orange	2	
3	white (green)	3	
4	blue	4	
5	white (blue)	5	
6	green	6	
7	white (brown)	7	
8	brown	8	

Technical data

Product type	Patch cable
Category	Cat.6 _A / Class E _A (ISO/IEC 11801 2010)
Shielding	S/FTP
Version connector left / Version connector right	RJ45 IP 20 / RJ45 IP 20
Connector standard	IEC 60603-7-51
PoE / PoE+	conforming to IEEE 802.3at
Cross-section	4*2*AWG 27/7 - 4*2*0.1 mm ²
Sheath diameter, max.	5.9 mm
Material sheath	LSZH
Colour	Green
Insulation diameter	1.04 mm
Min. bending radius, repetitive	50 mm
Min. bending radius, once only	25 mm
Ambient temperature (operational)	-20 °C...60 °C
Installation temperature	0 °C...50 °C
Storage temperature	-20 °C...60 °C
Halogen	halogen-free, according to IEC 60754-2
Resistance to spread of flame	in accordance with IEC 60332-1 / UL 1581 FT2
Approvals	CULUS
Note	

Product type	Patch cable
Category	Cat.6 _A / Class E _A (ISO/IEC 11801 2010)
Shielding	S/FTP
Version connector left / Version connector right	RJ45 IP 20 / RJ45 IP 20
Connector standard	IEC 60603-7-51
PoE / PoE+	conforming to IEEE 802.3at
Cross-section	4*2*AWG 27/7 - 4*2*0.1 mm ²
Sheath diameter, max.	5.9 mm
Material sheath	LSZH
Colour	Red
Insulation diameter	1.04 mm
Min. bending radius, repetitive	50 mm
Min. bending radius, once only	25 mm
Ambient temperature (operational)	-20 °C...60 °C
Installation temperature	0 °C...50 °C
Storage temperature	-20 °C...60 °C
Halogen	halogen-free, according to IEC 60754-2
Resistance to spread of flame	in accordance with IEC 60332-1 / UL 1581 FT2
Approvals	
Note	

Product type	Patch cable
Category	Cat.6 _A / Class E _A (ISO/IEC 11801 2010)
Shielding	S/FTP
Version connector left / Version connector right	RJ45 IP 20 / RJ45 IP 20
Connector standard	IEC 60603-7-51
PoE / PoE+	conforming to IEEE 802.3at
Cross-section	4*2*AWG 27/7 - 4*2*0.1 mm ²
Sheath diameter, max.	5.9 mm
Material sheath	LSZH
Colour	Red
Insulation diameter	1.04 mm
Min. bending radius, repetitive	50 mm
Min. bending radius, once only	25 mm
Ambient temperature (operational)	-20 °C...60 °C
Installation temperature	0 °C...50 °C
Storage temperature	-20 °C...60 °C
Halogen	halogen-free, according to IEC 60754-2
Resistance to spread of flame	in accordance with IEC 60332-1 / UL 1581 FT2
Approvals	
Note	

Ordering data

	0.2 m
	0.5 m
	1.0 m
	1.5 m
	2.0 m
	3.0 m
	5.0 m
	10.0 m
	15.0 m
	20.0 m
	25.0 m
Note	

Type	Qty.	Order No.
IE-C6FP8LG0002M40M40-G	1	1251590002
IE-C6FP8LG0005M40M40-G	1	1251590005
IE-C6FP8LG0010M40M40-G	1	1251590010
IE-C6FP8LG0015M40M40-G	1	1251590015
IE-C6FP8LG0020M40M40-G	1	1251590020
IE-C6FP8LG0030M40M40-G	1	1251590030
IE-C6FP8LG0050M40M40-G	1	1251590050
IE-C6FP8LG0100M40M40-G	1	1251590100
IE-C6FP8LG0150M40M40-G	1	1251590150
IE-C6FP8LG0200M40M40-G	1	1251590200
IE-C6FP8LG0250M40M40-G	1	1251590250

Type	Qty.	Order No.
IE-C6FP8LR0002M40M40-R	1	1166030002
IE-C6FP8LR0005M40M40-R	1	1166030005
IE-C6FP8LR0010M40M40-R	1	1166030010
IE-C6FP8LR0015M40M40-R	1	1166030015
IE-C6FP8LR0020M40M40-R	1	1166030020
IE-C6FP8LR0030M40M40-R	1	1166030030
IE-C6FP8LR0050M40M40-R	1	1166030050
IE-C6FP8LR0100M40M40-R	1	1166030100
IE-C6FP8LR0150M40M40-R	1	1166030150
IE-C6FP8LR0200M40M40-R	1	1166030200
IE-C6FP8LR0250M40M40-R	1	1166030250

Accessories

Sheathing stripper	
	For UTP and STP data cables
	For coaxial and round data cables
Markers	
	Insertion label, yellow, 12 mm
	Insertion label, yellow, 18 mm
Note	

Type	Qty.	Order No.
AM 12	1	9030060000
IE-CST	1	9204350000
TM-I 12 MC NE GE	320	1718411687
TM-I 18 MC NE GE	320	1718431687

Type	Qty.	Order No.
AM 12	1	9030060000
IE-CST	1	9204350000
TM-I 12 MC NE GE	320	1718411687
TM-I 18 MC NE GE	320	1718431687

Assembled cables - Patch cable

Assembled cables

Patch cable CabinetLine Cat. 6 straight

LSZH magenta



RJ45				RJ45
1	white (orange)	1		
2	orange	2		
3	white (green)	3		
4	blue	4		
5	white (blue)	5		
6	green	6		
7	white (brown)	7		
8	brown	8		

LSZH yellow



RJ45				RJ45
1	white (orange)	1		
2	orange	2		
3	white (green)	3		
4	blue	4		
5	white (blue)	5		
6	green	6		
7	white (brown)	7		
8	brown	8		

Technical data

Product type	Patch cable
Category	Cat.6 _A / Class E _A (ISO/IEC 11801 2010)
Shielding	S/FTP
Version connector left / Version connector right	RJ45 IP 20 / RJ45 IP 20
Connector standard	IEC 60603-7-51
PoE / PoE+	conforming to IEEE 802.3at
Cross-section	4*2*AWG 27/7 - 4*2*0.1 mm ²
Sheath diameter, max.	5.9 mm
Material sheath	LSZH
Colour	Magenta
Insulation diameter	1.04 mm
Min. bending radius, repetitive	50 mm
Min. bending radius, once only	25 mm
Ambient temperature (operational)	-20 °C...60 °C
Installation temperature	0 °C...50 °C
Storage temperature	-20 °C...60 °C
Halogen	halogen-free, according to IEC 60754-2
Resistance to spread of flame	in accordance with IEC 60332-1 / UL 1581 FT2
Approvals	CULUS
Note	

Product type	Patch cable
Category	Cat.6 _A / Class E _A (ISO/IEC 11801 2010)
Shielding	S/FTP
Version connector left / Version connector right	RJ45 IP 20 / RJ45 IP 20
Connector standard	IEC 60603-7-51
PoE / PoE+	conforming to IEEE 802.3at
Cross-section	4*2*AWG 27/7 - 4*2*0.1 mm ²
Sheath diameter, max.	5.9 mm
Material sheath	LSZH
Colour	Yellow
Insulation diameter	1.04 mm
Min. bending radius, repetitive	50 mm
Min. bending radius, once only	25 mm
Ambient temperature (operational)	-20 °C...60 °C
Installation temperature	0 °C...50 °C
Storage temperature	-20 °C...60 °C
Halogen	halogen-free, according to IEC 60754-2
Resistance to spread of flame	in accordance with IEC 60332-1 / UL 1581 FT2
Approvals	CULUS
Note	

Product type	Patch cable
Category	Cat.6 _A / Class E _A (ISO/IEC 11801 2010)
Shielding	S/FTP
Version connector left / Version connector right	RJ45 IP 20 / RJ45 IP 20
Connector standard	IEC 60603-7-51
PoE / PoE+	conforming to IEEE 802.3at
Cross-section	4*2*AWG 27/7 - 4*2*0.1 mm ²
Sheath diameter, max.	5.9 mm
Material sheath	LSZH
Colour	Yellow
Insulation diameter	1.04 mm
Min. bending radius, repetitive	50 mm
Min. bending radius, once only	25 mm
Ambient temperature (operational)	-20 °C...60 °C
Installation temperature	0 °C...50 °C
Storage temperature	-20 °C...60 °C
Halogen	halogen-free, according to IEC 60754-2
Resistance to spread of flame	in accordance with IEC 60332-1 / UL 1581 FT2
Approvals	CULUS
Note	

Ordering data

	0.2 m
	0.5 m
	1.0 m
	1.5 m
	2.0 m
	3.0 m
	5.0 m
	10.0 m
	15.0 m
	20.0 m
	25.0 m
Note	

Type	Qty.	Order No.
IE-C6FP8LM0002M40M40-M	1	1201270002
IE-C6FP8LM0005M40M40-M	1	1201270005
IE-C6FP8LM0010M40M40-M	1	1201270010
IE-C6FP8LM0015M40M40-M	1	1201270015
IE-C6FP8LM0020M40M40-M	1	1201270020
IE-C6FP8LM0030M40M40-M	1	1201270030
IE-C6FP8LM0050M40M40-M	1	1201270050
IE-C6FP8LM0100M40M40-M	1	1201270100
IE-C6FP8LM0150M40M40-M	1	1201270150
IE-C6FP8LM0200M40M40-M	1	1201270200
Note		

Type	Qty.	Order No.
IE-C6FP8LY0002M40M40-Y	1	1251580002
IE-C6FP8LY0005M40M40-Y	1	1251580005
IE-C6FP8LY0010M40M40-Y	1	1251580010
IE-C6FP8LY0015M40M40-Y	1	1251580015
IE-C6FP8LY0020M40M40-Y	1	1251580020
IE-C6FP8LY0030M40M40-Y	1	1251580030
IE-C6FP8LY0050M40M40-Y	1	1251580050
IE-C6FP8LY0100M40M40-Y	1	1251580100
IE-C6FP8LY0150M40M40-Y	1	1251580150
IE-C6FP8LY0200M40M40-Y	1	1251580200
IE-C6FP8LY0250M40M40-Y	1	1251580250
Note		

Accessories

Sheathing stripper	
	For UTP and STP data cables
	For coaxial and round data cables
Markers	
	Insertion label, yellow, 12 mm
	Insertion label, yellow, 18 mm
Note	

Type	Qty.	Order No.
AM 12	1	9030060000
IE-CST	1	9204350000
TM-H 12 MC NE GE	320	1718411687
TM-H 18 MC NE GE	320	1718431687
Note		

Type	Qty.	Order No.
AM 12	1	9030060000
IE-CST	1	9204350000
TM-H 12 MC NE GE	320	1718411687
TM-H 18 MC NE GE	320	1718431687
Note		

Assembled cables

Patch cable CabinetLine Cat. 6 angled

LSZH grey 270°



RJ45				RJ45
1	white (orange)	1		
2	orange	2		
3	white (green)	3		
4	blue	4		
5	white (blue)	5		
6	green	6		
7	white (brown)	7		
8	brown	8		

LSZH grey 90°



RJ45				RJ45
1	white (orange)	1		
2	orange	2		
3	white (green)	3		
4	blue	4		
5	white (blue)	5		
6	green	6		
7	white (brown)	7		
8	brown	8		

Technical data

Connector standard	IEC 60603-7-51
PoE / PoE+	conforming to IEEE 802.3at
Product type	Patch cable
Category	Cat.6 _A / Class E _A (ISO/IEC 11801 2010)
Shielding	S/FTP
Version connector left / Version connector right	RJ45 IP 20, Angled 270° / RJ45 IP 20
Cross-section	4*2*AWG 27/7 - 4*2*0.1 mm ²
Sheath diameter, max.	5.9 mm
Material sheath	LSZH
Colour	Grey
Insulation diameter	1.04 mm
Min. bending radius, repetitive	50 mm
Min. bending radius, once only	25 mm
Ambient temperature (operational)	-20 °C...60 °C
Installation temperature	0 °C...50 °C
Storage temperature	-20 °C...60 °C
Halogen	halogen-free, according to IEC 60754-2
Resistance to spread of flame	in accordance with IEC 60332-1 / UL 1581 FT2
Approvals	CULUS

Note

Ordering data

0.5 m	IE-C6FP8LD0005M40W40-D	1	1233160005
1.0 m	IE-C6FP8LD0010M40W40-D	1	1233160010
1.2 m	IE-C6FP8LD0012M40W40-D	1	1233160012
1.5 m	IE-C6FP8LD0015M40W40-D	1	1233160015
2.0 m	IE-C6FP8LD0020M40W40-D	1	1233160020
3.0 m	IE-C6FP8LD0030M40W40-D	1	1233160030
5.0 m	IE-C6FP8LD0050M40W40-D	1	1233160050
10.0 m	IE-C6FP8LD0100M40W40-D	1	1233160100

Note

Accessories

Sheathing stripper	
	For UTP and STP data cables
	For coaxial and round data cables
Markers	
	Insertion label, yellow, 12 mm
	Insertion label, yellow, 18 mm

Note

Type	Qty.	Order No.
IE-C6FP8LD0005M40W40-D	1	1233160005
IE-C6FP8LD0010M40W40-D	1	1233160010
IE-C6FP8LD0012M40W40-D	1	1233160012
IE-C6FP8LD0015M40W40-D	1	1233160015
IE-C6FP8LD0020M40W40-D	1	1233160020
IE-C6FP8LD0030M40W40-D	1	1233160030
IE-C6FP8LD0050M40W40-D	1	1233160050
IE-C6FP8LD0100M40W40-D	1	1233160100

Type	Qty.	Order No.
AM 12	1	9030060000
IE-CST	1	9204350000
TM-I 12 MC NE GE	320	1718411687
TM-I 18 MC NE GE	320	1718431687

Type	Qty.	Order No.
IE-C6FP8LD0005M40V40-D	1	1248280005
IE-C6FP8LD0010M40V40-D	1	1248280010
IE-C6FP8LD0012M40V40-D	1	1248280012
IE-C6FP8LD0015M40V40-D	1	1248280015
IE-C6FP8LD0020M40V40-D	1	1248280020
IE-C6FP8LD0030M40V40-D	1	1248280030
IE-C6FP8LD0050M40V40-D	1	1248280050
IE-C6FP8LD0100M40V40-D	1	1248280100

Type	Qty.	Order No.
AM 12	1	9030060000
IE-CST	1	9204350000
TM-I 12 MC NE GE	320	1718411687
TM-I 18 MC NE GE	320	1718431687

Assembled cables - Patch cable

Assembled cables

Patch cable CabinetLine Cat. 6 crossover

LSZH grey

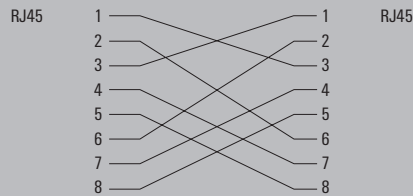

Technical data

Product type
Category
Shielding
Version connector left / Version connector right
Connector standard
PoE / PoE+
Cross-section
Sheath diameter, max.
Material sheath
Colour
Insulation diameter
Min. bending radius, repetitive
Min. bending radius, once only
Ambient temperature (operational)
Installation temperature
Storage temperature
Halogen
Resistance to spread of flame
Approvals

Patch cable, crossover
Cat.6 _A / Class E _A (ISO/IEC 11801 2010)
S/FTP
RJ45 IP 20 / RJ45 IP 20
IEC 60603-7-51
conforming to IEEE 802.3at
4*2*AWG 27/7 - 4*2*0.1 mm ²
5.9 mm
LSZH
Grey
1.04 mm
50 mm
25 mm
-20 °C...60 °C
0 °C...50 °C
-20 °C...60 °C
halogen-free, according to IEC 60754-2
in accordance with IEC 60332-1 / UL 1581 FT2
CULUS

Note

Ordering data

0.3 m
0.4 m
0.5 m
1.0 m
2.0 m
3.0 m
5.0 m
10.0 m
15.0 m
20.0 m

Type	Qty.	Order No.
IE-C6FP8LD0003X40X40-Y	1	1312160003
IE-C6FP8LD0004X40X40-Y	1	1312160004
IE-C6FP8LD0005X40X40-Y	1	1312160005
IE-C6FP8LD0010X40X40-Y	1	1312160010
IE-C6FP8LD0020X40X40-Y	1	1312160020
IE-C6FP8LD0030X40X40-Y	1	1312160030
IE-C6FP8LD0050X40X40-Y	1	1312160050
IE-C6FP8LD0100X40X40-Y	1	1312160100
IE-C6FP8LD0150X40X40-Y	1	1312160150
IE-C6FP8LD0200X40X40-Y	1	1312160200

Note

Accessories

Sheathing stripper	For UTP and STP data cables For coaxial and round data cables
Markers	Insertion label, yellow, 12 mm Insertion label, yellow, 18 mm

Type	Qty.	Order No.
AM 12	1	9030060000
IE-CST	1	9204350000
TMH 12 MC NE GE	320	1718411687
TMH 18 MC NE GE	320	1718431687

Note

Assembled cables

Patch cable CabinetLine Cat. 5 straight

PVC green



PUR green



RJ45			RJ45
1	white (orange)	1	RJ45
2	orange	2	
3	white (green)	3	
4	blue	4	
5	white (blue)	5	
6	green	6	
7	white (brown)	7	
8	brown	8	

RJ45			RJ45
1	white (orange)	1	RJ45
2	orange	2	
3	white (green)	3	
4	blue	4	
5	white (blue)	5	
6	green	6	
7	white (brown)	7	
8	brown	8	

Technical data

Product type	System cable
Category	Cat.5 (ISO/IEC 11801)
Shielding	SF/UTP
Version connector left / Version connector right	RJ45 IP 20 / RJ45 IP 20
Connector standard	IEC 60603-7-51
PoE / PoE+	conforming to IEEE 802.3at
Cross-section	4*2*AWG 26/7 - 4*2*0.128 mm ²
Sheath diameter, max.	5.8 mm
Material sheath	PVC
Sheathing colour	green (RAL 6018)
Insulation diameter	0.98 mm
Min. bending radius, repetitive	10 *diameter
Min. bending radius, once only	5 *diameter
Ambient temperature (operational)	-40 °C...75 °C
Abrasion resistance	good
Halogen	
Resistance to spread of flame	in accordance with IEC 60332-1
Resistance to oils	
Approvals	
Note	

Product type	System cable
Category	Cat.5 (ISO/IEC 11801)
Shielding	SF/UTP
Version connector left / Version connector right	RJ45 IP 20 / RJ45 IP 20
Connector standard	IEC 60603-7-51
PoE / PoE+	conforming to IEEE 802.3at
Cross-section	4*2*AWG 26/7 - 4*2*0.128 mm ²
Sheath diameter, max.	6 mm
Material sheath	PUR
Sheathing colour	green (RAL 6018)
Insulation diameter	0.98 mm
Min. bending radius, repetitive	10 *diameter
Min. bending radius, once only	5 *diameter
Ambient temperature (operational)	-40 °C...75 °C
Abrasion resistance	very good
Halogen	halogen-free, according to IEC 60754-2
Resistance to spread of flame	in accordance with IEC 60332-1
Resistance to oils	EN 50305
Approvals	
Note	

Product type	System cable
Category	Cat.5 (ISO/IEC 11801)
Shielding	SF/UTP
Version connector left / Version connector right	RJ45 IP 20 / RJ45 IP 20
Connector standard	IEC 60603-7-51
PoE / PoE+	conforming to IEEE 802.3at
Cross-section	4*2*AWG 26/7 - 4*2*0.128 mm ²
Sheath diameter, max.	6 mm
Material sheath	PUR
Sheathing colour	green (RAL 6018)
Insulation diameter	0.98 mm
Min. bending radius, repetitive	10 *diameter
Min. bending radius, once only	5 *diameter
Ambient temperature (operational)	-40 °C...75 °C
Abrasion resistance	very good
Halogen	halogen-free, according to IEC 60754-2
Resistance to spread of flame	in accordance with IEC 60332-1
Resistance to oils	EN 50305
Approvals	
Note	

Ordering data

	0.5 m
	1.0 m
	1.5 m
	2.0 m
	3.0 m
	5.0 m
	10.0 m
	15.0 m
	20.0 m
Note	

Type	Qty.	Order No.
IE-C5ES8VG0005M40M40-G	1	1166020005
IE-C5ES8VG0010M40M40-G	1	1166020010
IE-C5ES8VG0015M40M40-G	1	1166020015
IE-C5ES8VG0020M40M40-G	1	1166020020
IE-C5ES8VG0030M40M40-G	1	1166020030
IE-C5ES8VG0050M40M40-G	1	1166020050
IE-C5ES8VG0100M40M40-G	1	1166020100
IE-C5ES8VG0150M40M40-G	1	1166020150
IE-C5ES8VG0200M40M40-G	1	1166020200

Type	Qty.	Order No.
IE-C5ES8UG0005M40M40-G	1	1166000005
IE-C5ES8UG0010M40M40-G	1	1166000010
IE-C5ES8UG0015M40M40-G	1	1166000015
IE-C5ES8UG0020M40M40-G	1	1166000020
IE-C5ES8UG0030M40M40-G	1	1166000030
IE-C5ES8UG0050M40M40-G	1	1166000050
IE-C5ES8UG0100M40M40-G	1	1166000100
IE-C5ES8UG0150M40M40-G	1	1166000150
IE-C5ES8UG0200M40M40-G	1	1166000200

Accessories

Sheathing stripper	
	For UTP and STP data cables
	For coaxial and round data cables
Markers	
	Insertion label, yellow, 12 mm
	Insertion label, yellow, 18 mm
Note	

Type	Qty.	Order No.
AM 12	1	9030060000
IE-CST	1	9204350000
TMH 12 MC NE GE	320	1718411687
TMH 18 MC NE GE	320	1718431687

Type	Qty.	Order No.
AM 12	1	9030060000
IE-CST	1	9204350000
TMH 12 MC NE GE	320	1718411687
TMH 18 MC NE GE	320	1718431687

Assembled cables - Patch cable

Assembled cables

Patch cable CabinetLine Cat. 6 straight

PUR green



RJ45			RJ45
1	white (orange)	1	RJ45
2	orange	2	
3	white (green)	3	
4	blue	4	
5	white (blue)	5	
6	green	6	
7	white (brown)	7	
8	brown	8	

Technical data

Product type	System cable
Category	Cat.6 _A / Class E _A (ISO/IEC 11801 2010)
Shielding	
Version connector left / Version connector right	RJ45 IP 20 / RJ45 IP 20
Connector standard	IEC 60603-7-51
PoE / PoE+	conforming to IEEE 802.3at
Cross-section	4*2*AWG 27/7 - 4*2*0.1 mm ²
Sheath diameter, max.	6.4 mm
Material sheath	PUR
Sheathing colour	green (RAL 6018)
Insulation diameter	1.02 mm
Min. bending radius, repetitive	10 *diameter
Min. bending radius, once only	5 *diameter
Ambient temperature (operational)	-40 °C...85 °C
Abrasion resistance	very good
Halogen	halogen-free, according to IEC 60754-2
Resistance to spread of flame	in accordance with IEC 60332-1 / UL 1581 FT2
Resistance to oils	in accordance with IEC 60811-2-1
Approvals	

Note

Ordering data

	0.3 m
	0.5 m
	1.0 m
	1.5 m
	2.0 m
	3.0 m
	5.0 m
	10.0 m
	15.0 m
	20.0 m

Note

Accessories

Sheathing stripper

For UTP and STP data cables
For coaxial and round data cables

Markers

Wire and cable marker. ø 4.7 - 7.4 mm
Wire and cable marker. ø 5.8 - 7.8 mm
Insertion label, yellow. 12 mm
Insertion label, yellow. 18 mm
Transparent sleeves. 12-mm length
Transparent sleeves. 18-mm length

Note

Type	Qty.	Order No.
IE-C6FS8UG0003A40A40-G	1	894 1350003
IE-C6FS8UG0005A40A40-G	1	894 1350005
IE-C6FS8UG0010A40A40-G	1	894 1350010
IE-C6FS8UG0015A40A40-G	1	894 1350015
IE-C6FS8UG0020A40A40-G	1	894 1350020
IE-C6FS8UG0030A40A40-G	1	894 1350030
IE-C6FS8UG0050A40A40-G	1	894 1350050
IE-C6FS8UG0100A40A40-G	1	894 1350100
IE-C6FS8UG0150A40A40-G	1	894 1350150
IE-C6FS8UG0200A40A40-G	1	894 1350200

Other lengths available on request

Type	Qty.	Order No.
AM 12	1	9030060000
IE-CST	1	9204350000
VT SF 5/21 MC NE WS V0	160	1689470001
VT SF 6/21 MC NE WS V0	160	1730560001
TMH 12 MC NE GE	320	1718411687
TMH 18 MC NE GE	320	1718431687
TM 4/12 HF/HB	500	1719840000
TM 4/18 HF/HB	500	1719850000

Assembled cables

Patch cable PROFINET dragline cable (type C)

Cat. 5

IP 67

V14 RJ45 IP 67



RJ45		RJ45
1	yellow	1
2	orange	2
3	white	3
6	blue	6

Technical data

Product type	Dragline cable
Category	Cat.5 (ISO/IEC 11801) / Cat.5e (TIA T568-B)
Connector standard	IEC 61076-3-117 Var. 14, IEC 60603-7-51
Shielding	SF/UTP
Version connector left / Version connector right	RJ45 IP 67 PushPull V14 metal / RJ45 IP 67 PushPull V14 metal
Cross-section	4*AWG 22/7 - 0.36 mm ²
Sheath diameter, max.	6.7 mm
Material sheath	PUR
Insulation diameter	1.5 mm
Min. bending radius, repetitive / Min. bending radius, once only	7.5 *diameter / 5 *diameter
Bending cycles	3 Mio
Speed	180 m/min
Acceleration	4 m/s ²
Pulling force	≤ 150 N
Ambient temperature (operational)	-40 °C...70 °C
Installation temperature	-20 °C...60 °C
Storage temperature	-50 °C...70 °C
Abrasion resistance	very good
Halogen	halogen-free, according to IEC 60754-2
Resistance to spread of flame	in accordance with IEC 60332-1
Resistance to oils	in accordance with IEC 60811-2-1
Approvals	

Note

Ordering data

	Type	Qty.	Order No.
1.0 m	IE-C5DD4UG0010A2EA2E-X	1	1119730010
2.0 m	IE-C5DD4UG0020A2EA2E-X	1	1119730020
3.0 m	IE-C5DD4UG0030A2EA2E-X	1	1119730030
5.0 m	IE-C5DD4UG0050A2EA2E-X	1	1119730050
10.0 m	IE-C5DD4UG0100A2EA2E-X	1	1119730100
15.0 m	IE-C5DD4UG0150A2EA2E-X	1	1119730150
20.0 m	IE-C5DD4UG0200A2EA2E-X	1	1119730200

Note

Accessories

Sheathing stripper		Type	Qty.	Order No.
	For UTP and STP data cables	AM 12	1	9030060000
	For coaxial and round data cables	IE-CST	1	9204350000
Markers				
	Insertion label, yellow, 12 mm	TMH 12 MC NE GE	320	1718411687
	Insertion label, yellow, 18 mm	TMH 18 MC NE GE	320	1718431687

Note

Assembled cables - PROFINET cable

Assembled cables

Patch cable PROFINET (Type C) Cat. 5, over-moulded

IP 67

V14 RJ45 IP 67

Dragline cable



RJ45		RJ45
1	yellow	1
2	orange	2
3	white	3
6	blue	6

V14 RJ45 IP 67

Twisted cable



RJ45		RJ45
1	yellow	1
2	orange	2
3	white	3
6	blue	6

Technical data

Product type
Category
Connector standard
Shielding
Version connector left / Version connector right

Cross-section
Sheath diameter, max.
Material sheath
Insulation diameter
Min. bending radius, repetitive / Min. bending radius, once only
Bending cycles / Pulling force
Torsion cycles / Torsion resistance
Speed / Acceleration
Ambient temperature (operational)
Installation temperature
Storage temperature
Abrasion resistance
Halogen
Resistance to spread of flame
Resistance to oils
Approvals

Note

Dragline cable
Cat.5 (ISO/IEC 11801) / Cat.5e (TIA T568-B)
IEC 61076-3-107
SF/UTP
RJ45 IP 67 PushPull moulded V14 metal / RJ45 IP 67 PushPull moulded V14 metal
4*AWG 22/7 - 0.36 mm²
6.7 mm
PUR
1.5 mm
7.5 *diameter / 5 *diameter
3 Mio / ≤ 150 N

180 m/min / 4 m/s²
-40 °C...70 °C
-20 °C...60 °C
-50 °C...70 °C
very good
halogen-free, according to IEC 60754-2
in accordance with IEC 60332-1
in accordance with IEC 60811-2-1

Torsion cable
Cat.5 (ISO/IEC 11801) / Cat.5e (TIA T568-B)
IEC 61076-3-107
S/UTP
RJ45 IP 67 PushPull moulded V14 metal / RJ45 IP 67 PushPull moulded V14 metal
4* AWG 22/19 - 0.38 mm²
6.7 mm
PUR
1.5 mm
10 *diameter / 5 *diameter

1 mill. / 180 °/m
-40 °C...80 °C
-40 °C...80 °C
-40 °C...80 °C
very good
halogen-free, according to IEC 60754-2
in accordance with IEC 60332-1
in accordance with IEC 60811-2-1

Ordering data

	1.0 m
	2.0 m
	3.0 m
	5.0 m
	10.0 m

Note

Type	Qty.	Order No.
IE-C5DD4UG0010B2EB2E-X	1	1307610010
IE-C5DD4UG0020B2EB2E-X	1	1307610020
IE-C5DD4UG0030B2EB2E-X	1	1307610030
IE-C5DD4UG0050B2EB2E-X	1	1307610050
IE-C5DD4UG0100B2EB2E-X	1	1307610100

Type	Qty.	Order No.
IE-C5IT4UG0010B2EB2E-X	1	1312690010
IE-C5IT4UG0020B2EB2E-X	1	1312690020
IE-C5IT4UG0030B2EB2E-X	1	1312690030
IE-C5IT4UG0050B2EB2E-X	1	1312690050
IE-C5IT4UG0100B2EB2E-X	1	1312690100

Accessories

Sheathing stripper

For UTP and STP data cables
For coaxial and round data cables

Markers

Insertion label, yellow, 12 mm
Insertion label, yellow, 18 mm

Type	Qty.	Order No.
AM 12	1	9030060000
IE-CST	1	9204350000
TM-I 12 MC NE GE	320	1718411687
TM-I 18 MC NE GE	320	1718431687

Type	Qty.	Order No.
AM 12	1	9030060000
IE-CST	1	9204350000
TM-I 12 MC NE GE	320	1718411687
TM-I 18 MC NE GE	320	1718431687

Note

Assembled cables
Patch cable PushPull Power

Power IP 67, PVC



Power IP 67, PUR



Technical data

Connector standard
Version connector left / Version connector right
Ambient temperature (operational)
Cross-section
Wire connection cross section AWG, max.
Sheath diameter, max.
Material sheath
Sheathing colour
Insulation
No. of wires
Min. bending radius, once only
Rated voltage
Current-carrying capacity at 50 °C
Approvals

in accordance with PROFINET specification
PushPull Power / PushPull Power
-40 °C...70 °C
5*1,5 mm ²
AWG 16
8.1 mm
PVC
grey (similar to RAL 7001)
PVC
5
4 *diameter
24 V
16 A
EAC

in accordance with PROFINET specification
PushPull Power / PushPull Power
-40 °C...80 °C
5*1,5 mm ²
AWG 16
9 mm
PUR
grey (similar to RAL 7001)
TPE
5
5 *diameter
24 V
16 A
EAC

Note

Ordering data

	1.0 m
	3.0 m
	5.0 m
	10.0 m
	15.0 m
	20.0 m

Type	Qty.	Order No.
IE-CSPS5VS0010VAPVAP-X	1	1350120010
IE-CSPS5VS0030VAPVAP-X	1	1350120030
IE-CSPS5VS0050VAPVAP-X	1	1350120050
IE-CSPS5VS0100VAPVAP-X	1	1350120100
IE-CSPS5VS0150VAPVAP-X	1	1350120150
IE-CSPS5VS0200VAPVAP-X	1	1350120200

Type	Qty.	Order No.
IE-CSPD5US0050VAPVAP-X	1	1403680050
IE-CSPD5US0100VAPVAP-X	1	1403680100
IE-CSPD5US0150VAPVAP-X	1	1403680150

Note

Other lengths available on request

Accessories

Sheathing stripper
For UTP and STP data cables
For coaxial and round data cables
Markers
Insertion label, yellow, 12 mm
Insertion label, yellow, 18 mm

Type	Qty.	Order No.
AM 12	1	9030060000
IE-CST	1	9204350000
TM-I 12 MC NE GE	320	1718411687
TM-I 18 MC NE GE	320	1718431687

Type	Qty.	Order No.
AM 12	1	9030060000
IE-CST	1	9204350000
TM-I 12 MC NE GE	320	1718411687
TM-I 18 MC NE GE	320	1718431687

Note

Assembled cables – PROFINET cable M12

Assembled cables

M12 dragline cable, angled

- Cat. 5
- PUR
- D-coded
- PROFINET type C

M12 / M12

Plug / plug



M12 / M12

Plug / plug

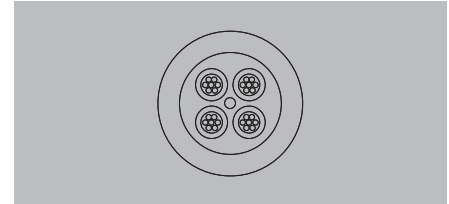
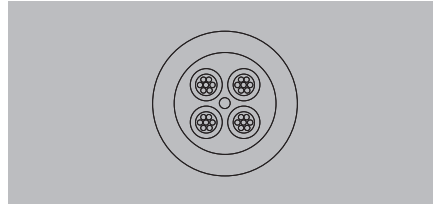
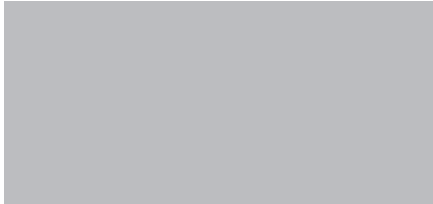

Technical data

Product type
Category
Shielding
Version connector left / Version connector right
Cross-section
Sheath diameter, max.
Material sheath
Sheathing colour
Insulation diameter, min. / max.
Min. bending radius, repetitive
Ambient temperature (operational)
Installation temperature
Storage temperature
Abrasion resistance
Halogen
Resistance to oils
Fire safety for railway vehicles

Dragline cable
Cat.5 (ISO/IEC 11801) / Cat.5e (TIA T568-B)
SF/UTP
M12 IP 67 straight male / M12 IP 67 straight male
4*AWG 22/7 - 0.36 mm ²
6.7 mm
PUR
green (RAL 6018)
1.5 mm
7.5 *diameter
-40 °C...70 °C
-20 °C...60 °C
-50 °C...70 °C
very good
halogen-free, according to IEC 60754-2
in accordance with IEC 60811-2-1

Dragline cable
Cat.5 (ISO/IEC 11801) / Cat.5e (TIA T568-B)
SF/UTP
M12 IP 67 angled male / M12 IP 67 angled male
4*AWG 22/7 - 0.36 mm ²
6.7 mm
PUR
green (RAL 6018)
1.5 mm
7.5 *diameter
-40 °C...70 °C
-20 °C...60 °C
-50 °C...70 °C
very good
halogen-free, according to IEC 60754-2
in accordance with IEC 60811-2-1

Note

Ordering data

Cat. 5 PROFINET. PUR. M12 straight-M12 angled	
1.5 m	
3.0 m	
5.0 m	
10.0 m	
Cat. 5 PROFINET. PUR. M12 angled-M12 angled	
1.5 m	
3.0 m	
5.0 m	
10.0 m	
Cat. 5. PUR. M12 angled-open	
1.5 m	
3.0 m	
5.0 m	
10.0 m	

Note

Type	Qty.	Order No.
IE-C5DD4UG0015MCSMCA-E	1	1059770015
IE-C5DD4UG0030MCSMCA-E	1	1059770030
IE-C5DD4UG0050MCSMCA-E	1	1059770050
IE-C5DD4UG0100MCSMCA-E	1	1059770100

Type	Qty.	Order No.

IE-C5DD4UG0015MCAMCA-E	1	1059890015
IE-C5DD4UG0030MCAMCA-E	1	1059890030
IE-C5DD4UG0050MCAMCA-E	1	1059890050
IE-C5DD4UG0100MCAMCA-E	1	1059890100

Accessories

Markers	
Insertion label, yellow, 12 mm	
Insertion label, yellow, 18 mm	
Transparent sleeves, 12-mm length	
Transparent sleeves, 18-mm length	

Type	Qty.	Order No.
TM-H 12 MC NE GE	320	1718411687
TM-H 18 MC NE GE	320	1718431687
TM 4/12 HF/HB	500	1719840000
TM 4/18 HF/HB	500	1719850000

Type	Qty.	Order No.
TM-H 12 MC NE GE	320	1718411687
TM-H 18 MC NE GE	320	1718431687
TM 4/12 HF/HB	500	1719840000
TM 4/18 HF/HB	500	1719850000

Note

Assembled cables – PROFINET cable M12

Assembled cables

System cable M12 flange

- Cat. 5
- PUR
- D-coded
- PROFINET type B

M12 flange - M12 male

Plug / socket



M12 flange - RJ45

Plug / socket



M12		M12
1	yellow	1
2	white	2
3	orange	3
4	blue	4

M12		M12
1	yellow	1
2	white	2
3	orange	3
4	blue	4

Technical data

Product type
Category
Shielding
Version connector left / Version connector right
Cross-section
Sheath diameter, max.
Material sheath
Sheathing colour
Insulation diameter
Min. bending radius, repetitive
Min. bending radius, once only
Ambient temperature (operational)
Installation temperature
Storage temperature
Approvals

Note

System cable
Cat.5 (ISO/IEC 11801) / Cat.5e (TIA T568-B)
360° shield contact
M12 flange / M12 - male / straight
4*AWG 22/7 - 0.36 mm ²
6.7 mm
PUR
green (RAL 6018)
1.5 mm
15 x cable diameter
5 x cable diameter
-40 °C...70 °C
-20 °C...60 °C
-50 °C...70 °C

System cable
Cat.5 (ISO/IEC 11801) / Cat.5e (TIA T568-B)
360° shield contact
M12 flange / RJ45 IP 20
4*AWG 22/7 - 0.36 mm ²
6.7 mm
PUR
green (RAL 6018)
1.5 mm
15 x cable diameter
5 x cable diameter
-40 °C...70 °C
-20 °C...60 °C
-50 °C...70 °C

Ordering data

0.5 m
1.0 m
1.5 m
2.0 m
5.0 m

Note

Type	Qty.	Order No.
IE-C5DS4UG0005MBSMCS-E	1	1244130005
IE-C5DS4UG0010MBSMCS-E	1	1244130010
IE-C5DS4UG0015MBSMCS-E	1	1244130015
IE-C5DS4UG0020MBSMCS-E	1	1244130020
IE-C5DS4UG0050MBSMCS-E	1	1244130050

Type	Qty.	Order No.
IE-C5DS4UG0005MBSA20-E	1	1234750005
IE-C5DS4UG0010MBSA20-E	1	1234750010
IE-C5DS4UG0015MBSA20-E	1	1234750015
IE-C5DS4UG0020MBSA20-E	1	1234750020
IE-C5DS4UG0050MBSA20-E	1	1234750050

Accessories

Markers

Insertion label, yellow, 12 mm
Insertion label, yellow, 18 mm

Mounting tool

Tool set
Tool set with torque function
Screwty-M12-DM
Screwty-M12

Type	Qty.	Order No.
TM-I 12 MC NE GE	320	1718411687
TM-I 18 MC NE GE	320	1718431687
Screwty Set	1	1910000000
Screwty Set -DM	1	1920000000
Screwty-M12-DM	1	1900001000
Screwty- M12	1	1900000000

Type	Qty.	Order No.
TM-I 12 MC NE GE	320	1718411687
TM-I 18 MC NE GE	320	1718431687
Screwty Set	1	1910000000
Screwty Set -DM	1	1920000000
Screwty-M12-DM	1	1900001000
Screwty- M12	1	1900000000

Note

Assembled cables**System cable M12 flange**

- Cat. 5
- PUR
- D-coded
- PROFINET type B

M12 flange - open

Socket / -



	M12
yellow	1
white	2
orange	3
blue	4

Technical data

Product type
Category
Shielding
Version connector left / Version connector right
Cross-section
Sheath diameter, max.
Material sheath
Sheathing colour
Insulation diameter
Min. bending radius, repetitive
Min. bending radius, once only
Ambient temperature (operational)
Installation temperature
Storage temperature
Approvals

System cable
Cat.5 (ISO/IEC 11801) / Cat.5e (TIA T568-B)
360° shield contact
M12 flange / Open
4*AWG 22/7 - 0.36 mm ²
6.7 mm
PUR
green (RAL 6018)
1.5 mm
15 x cable diameter
5 x cable diameter
-40 °C...70 °C
-20 °C...60 °C
-50 °C...70 °C

Note**Ordering data**

0.5 m
1.0 m
1.5 m
2.0 m
5.0 m

Type	Qty.	Order No.
IE-C5DS4UG0005MBSXXX-E	1	1234770005
IE-C5DS4UG0010MBSXXX-E	1	1234770010
IE-C5DS4UG0015MBSXXX-E	1	1234770015
IE-C5DS4UG0020MBSXXX-E	1	1234770020
IE-C5DS4UG0050MBSXXX-E	1	1234770050

Note**Accessories****Markers**

Insertion label, yellow, 12 mm
Insertion label, yellow, 18 mm

Type	Qty.	Order No.
TMH 12 MC NE GE	320	1718411687
TMH 18 MC NE GE	320	1718431687

Mounting tool

Tool set
Tool set with torque function
Screwty-M12-DM
Screwty-M12

Screwty Set	1	1910000000
Screwty Set -DM	1	1920000000
Screwty-M12-DM	1	1900001000
Screwty- M12	1	1900000000

Note

Assembled cables – PROFINET cable M12

Assembled cable

Connecting cable M12

- Cat. 6
- PVC
- X-type
- PROFINET type B

M12 - M12

Plug / plug



M12 - open

Plug / -

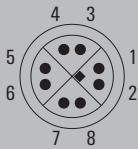

M12	1	white, orange	1	M12
	2	orange	2	
	3	white, green	3	
	4	green	4	
	5	white, brown	5	
	6	brown	6	
	7	white, blue	7	
	8	blue	8	

	White, Orange	1	M12
	Orange	2	
	White, Green	3	
	Green	4	
	White, Brown	5	
	Brown	6	
	White, Blue	7	
	Blue	8	

Technical data

Product type	Connecting cables
Category	Cat.6 _A / Class E _A (ISO/IEC 11801 2010)
Shielding	S/FTP
Version connector left / Version connector right	M12 X-type IP 67 straight male / M12 X-type IP 67 straight male
Cross-section	4*2*AWG 23/7
Sheath diameter, max.	8.8 mm
Material sheath	PVC
Sheathing colour	green (RAL 6018)
Insulation diameter	1.58 mm
Min. bending radius, repetitive	8 *diameter
Min. bending radius, once only	4 *diameter
Pulling force	≤ 150 N
Ambient temperature (operational)	-40 °C...80 °C
Installation temperature	-40 °C...80 °C
Storage temperature	-40 °C...80 °C
Halogen	
Resistance to spread of flame	in accordance with IEC 60332-1-2
Standard, assembly	UL-Style 2461
Approvals	
Note	

Product type	Connecting cables
Category	Cat.6 _A / Class E _A (ISO/IEC 11801 2010)
Shielding	S/FTP
Version connector left / Version connector right	M12 X-type IP 67 straight male / Open
Cross-section	4*2*AWG 23/7
Sheath diameter, max.	8.8 mm
Material sheath	PVC
Sheathing colour	green (RAL 6018)
Insulation diameter	1.58 mm
Min. bending radius, repetitive	8 *diameter
Min. bending radius, once only	4 *diameter
Pulling force	≤ 150 N
Ambient temperature (operational)	-40 °C...80 °C
Installation temperature	-40 °C...80 °C
Storage temperature	-40 °C...80 °C
Halogen	
Resistance to spread of flame	in accordance with IEC 60332-1-2
Standard, assembly	UL-Style 2461
Approvals	
Note	

Product type	Connecting cables
Category	Cat.6 _A / Class E _A (ISO/IEC 11801 2010)
Shielding	S/FTP
Version connector left / Version connector right	M12 X-type IP 67 straight male / Open
Cross-section	4*2*AWG 23/7
Sheath diameter, max.	8.8 mm
Material sheath	PVC
Sheathing colour	green (RAL 6018)
Insulation diameter	1.58 mm
Min. bending radius, repetitive	8 *diameter
Min. bending radius, once only	4 *diameter
Pulling force	≤ 150 N
Ambient temperature (operational)	-40 °C...80 °C
Installation temperature	-40 °C...80 °C
Storage temperature	-40 °C...80 °C
Halogen	
Resistance to spread of flame	in accordance with IEC 60332-1-2
Standard, assembly	UL-Style 2461
Approvals	
Note	

Ordering data

	0.5 m
	1.5 m
	3.0 m
	5.0 m
	10.0 m
Note	

Type	Qty.	Order No.
IE-C6KS8VGG0005XCSXCS-E	1	1398070005
IE-C6KS8VGG0015XCSXCS-E	1	1398070015
IE-C6KS8VGG0030XCSXCS-E	1	1398070030
IE-C6KS8VGG0050XCSXCS-E	1	1398070050
IE-C6KS8VGG0100XCSXCS-E	1	1398070100

Type	Qty.	Order No.
IE-C6KS8VGG0005XCSXXX-E	1	1449470005
IE-C6KS8VGG0015XCSXXX-E	1	1449470015
IE-C6KS8VGG0050XCSXXX-E	1	1449470050
IE-C6KS8VGG0100XCSXXX-E	1	1449470100

Accessories

Markers	
	Insertion label, yellow, 12 mm
	Insertion label, yellow, 18 mm

Type	Qty.	Order No.
TM-I 12 MC NE GE	320	1718411687
TM-I 18 MC NE GE	320	1718431687

Type	Qty.	Order No.
TM-I 12 MC NE GE	320	1718411687
TM-I 18 MC NE GE	320	1718431687

Note

Note

Note

Assembled cables

M12 connecting cables

- Cat. 6
- PUR
- X-type

M12 - RJ45

Plug / plug

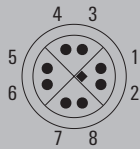

RJ45		M12
1	White, Orange	1
2	Orange	2
3	White, Green	3
4	Blue	8
5	White, Blue	7
6	Green	4
7	White, Brown	5
8	Brown	6

Technical data

Product type	System cable
Category	Cat.6 _n / Class E _n (ISO/IEC 11801 2010)
Shielding	S/FTP
Version connector left / Version connector right	RJ45 IP 20 / M12 X-type IP 67 straight male
Cross-section	4*2*AWG 26/7 - 4*2*0.128 mm ²
Sheath diameter, max.	6.7 mm
Material sheath	PUR
Sheathing colour	green (RAL 6018)
Insulation diameter	0.98 mm
Min. bending radius, repetitive	10 *diameter
Min. bending radius, once only	5 *diameter
Pulling force	
Ambient temperature (operational)	-40 °C...80 °C
Installation temperature	-20 °C...60 °C
Storage temperature	-40 °C...80 °C
Halogen	halogen-free, according to IEC 60754-1
Resistance to spread of flame	in accordance with IEC 60332-1-2
Standard, assembly	UL Style 20963
Approvals	
Note	

Type	Qty.	Order No.
IE-C6ES8UG0010A40XCS-E	1	1457580010
IE-C6ES8UG0020A40XCS-E	1	1457580020
IE-C6ES8UG0030A40XCS-E	1	1457580030
IE-C6ES8UG0050A40XCS-E	1	1457580050
IE-C6ES8UG0100A40XCS-E	1	1457580100
IE-C6ES8UG0120A40XCS-E	1	1457580120

Ordering data

	1.0 m
	2.0 m
	3.0 m
	5.0 m
	10.0 m
	12.0 m
Note	

Type	Qty.	Order No.
TMH 12 MC NE GE	320	1718411687
TMH 18 MC NE GE	320	1718431687

Accessories

Markers	
	Insertion label, yellow, 12 mm
	Insertion label, yellow, 18 mm

Type	Qty.	Order No.
TMH 12 MC NE GE	320	1718411687
TMH 18 MC NE GE	320	1718431687

Note

Note

Assembled cables

EtherNet/IP patch cable

- in PUR

V1 RJ45 IP 67 - metal



V1 RJ45 IP 67 - plastic



RJ45			RJ45
1	white (orange)	1	RJ45
2	orange	2	
3	white (green)	3	
4	blue	4	
5	white (blue)	5	
6	green	6	
7	white (brown)	7	
8	brown	8	

RJ45			RJ45
1	white (orange)	1	RJ45
2	orange	2	
3	white (green)	3	
4	blue	4	
5	white (blue)	5	
6	green	6	
7	white (brown)	7	
8	brown	8	

Technical data

Product type
Category
Shielding
Version connector left / Version connector right
Cross-section
Sheath diameter, max.
Material sheath
Sheathing colour
Insulation diameter
Min. bending radius, repetitive
Min. bending radius, once only
Ambient temperature (operational)
Installation temperature
Storage temperature
Abrasion resistance
Halogen
Resistance to spread of flame
Resistance to oils
Approvals

Note

System cable
Cat.5 (ISO/IEC 11801) / Cat.5e (TIA T568-B)
SF/UTP
RJ45 IP 67 Baymo V01 metal / RJ45 IP 67 Baymo V01 metal
4*2*AWG 26/7 - 4*2*0.128 mm ²
6.1 mm
PUR
green (RAL 6018)
1 mm
10 *diameter
5 *diameter
-40 °C...80 °C
-10 °C...60 °C
-40 °C...80 °C
very good
halogen-free, according to IEC 60754-2
in accordance with IEC 60332-1
in accordance with IEC 60811-2-1
CULUS

System cable
Cat.5 (ISO/IEC 11801) / Cat.5e (TIA T568-B)
SF/UTP
RJ45 IP 67 Baymo V01 plastic / RJ45 IP 67 Baymo V01 plastic
4*2*AWG 26/7 - 4*2*0.128 mm ²
6.1 mm
PUR
green (RAL 6018)
1 mm
10 *diameter
5 *diameter
-40 °C...80 °C
-10 °C...60 °C
-40 °C...80 °C
very good
halogen-free, according to IEC 60754-2
in accordance with IEC 60332-1
in accordance with IEC 60811-2-1
CULUS

Ordering data

1.0 m
2.0 m
5.0 m
10.0 m

Note

Type	Qty.	Order No.
IE-C5ES8UG0010B41B41-E	1	1066850000
IE-C5ES8UG0020B41B41-E	1	1066860000
IE-C5ES8UG0050B41B41-E	1	1066870000
IE-C5ES8UG0100B41B41-E	1	1066880000

Type	Qty.	Order No.
IE-C5ES8UG0010P41P41-E	1	1106010000
IE-C5ES8UG0020P41P41-E	1	1106020000
IE-C5ES8UG0050P41P41-E	1	1106030000
IE-C5ES8UG0100P41P41-E	1	1106040000

Accessories

Markers	
	Insertion label, yellow, 12 mm
	Insertion label, yellow, 18 mm

Type	Qty.	Order No.
TM-I 12 MC NE GE	320	1718411687
TM-I 18 MC NE GE	320	1718431687

Type	Qty.	Order No.
TM-I 12 MC NE GE	320	1718411687
TM-I 18 MC NE GE	320	1718431687

Note

**Assembled cable
Railway cable M12**

- Cat. 5
- Radox
- D-coded

M12 - M12

Plug / plug



M12 - M12

Plug / socket



M12		M12
1	yellow	1
2	white	2
3	orange	3
4	blue	4

M12		M12
1	yellow	1
2	white	2
3	orange	3
4	blue	4

Technical data

Product type
Category
Shielding
Version connector left / Version connector right
Cross-section
Sheath diameter, max.
Material sheath
Sheathing colour
Insulation diameter
Min. bending radius, repetitive
Ambient temperature (operational)
Installation temperature
Storage temperature
Abrasion resistance
Halogen
Resistance to oils
Fire safety for railway vehicles

System cable
Cat.5 (ISO/IEC 11801) / Cat.5e (TIA T568-B)
SF/UTP
M12 IP 67 straight male / M12 IP 67 straight male
2*2*AWG 22/7 - 2*2*0.36 mm ²
7.55 mm
Radox GKW S
Black
1.95 mm
6 *diameter
-40 °C...90 °C
-25 °C...90 °C
-40 °C...90 °C
very good
halogen-free, according to IEC 60754-2
in accordance with EN 50306-3
According to DIN 5510-2 fire safety levels 1,2,3,4, According to BS 6853, According to EN50288-2-2
CULUS

System cable
Cat.5 (ISO/IEC 11801) / Cat.5e (TIA T568-B)
SF/UTP
M12 IP 67 straight male / M12 IP 67 straight socket
2*2*AWG 22/7 - 2*2*0.36 mm ²
7.55 mm
Radox GKW S
Black
1.95 mm
6 *diameter
-40 °C...90 °C
-25 °C...90 °C
-40 °C...90 °C
very good
halogen-free, according to IEC 60754-2
in accordance with EN 50306-3
According to DIN 5510-2 fire safety levels 1,2,3,4, According to BS 6853, According to EN50288-2-2
CULUS

Approvals

Note

Ordering data

1.5 m
3.0 m
5.0 m
10.0 m

Note

Type	Qty.	Order No.
IE-C5DB4RE0015MCSMCS-E	1	1010850015
IE-C5DB4RE0030MCSMCS-E	1	1010850030
IE-C5DB4RE0050MCSMCS-E	1	1010850050
IE-C5DB4RE0100MCSMCS-E	1	1010850100

Type	Qty.	Order No.
IE-C5DB4RE0015MSSMCS-E	1	1059340015
IE-C5DB4RE0030MSSMCS-E	1	1059340030
IE-C5DB4RE0050MSSMCS-E	1	1059340050
IE-C5DB4RE0100MSSMCS-E	1	1059340100

Accessories

Markers	
	Insertion label, yellow, 12 mm
	Insertion label, yellow, 18 mm

Type	Qty.	Order No.
TM-I 12 MC NE GE	320	1718411687
TM-I 18 MC NE GE	320	1718431687

Type	Qty.	Order No.
TM-I 12 MC NE GE	320	1718411687
TM-I 18 MC NE GE	320	1718431687

Note

Assembled cables - Railway cable M12

Assembled cable
Railway cable M12

- Cat. 5
- Radox
- D-coded

M12 - open

Plug / -



	M12
yellow	1
white	2
orange	3
blue	4

Technical data

Product type	System cable
Category	Cat.5 (ISO/IEC 11801) / Cat.5e (TIA T568-B)
Shielding	SF/UTP
Version connector left / Version connector right	M12 IP 67 straight male / Open
Cross-section	2*2*AWG 22/7 - 2*2*0.36 mm ²
Sheath diameter, max.	7.55 mm
Material sheath	Radox GKW S
Sheathing colour	Black
Insulation diameter	1.95 mm
Min. bending radius, repetitive	6 *diameter
Ambient temperature (operational)	-40 °C...90 °C
Installation temperature	-25 °C...90 °C
Storage temperature	-40 °C...90 °C
Abrasion resistance	very good
Halogen	halogen-free, according to IEC 60754-2
Resistance to oils	in accordance with EN 50306-3
Fire safety for railway vehicles	According to DIN 5510-2 fire safety levels 1,2,3,4, According to BS 6853, According to EN50288-2-2
Approvals	CULUS
Note	

Ordering data

	1.5 m	Type	Qty.	Order No.
	3.0 m	IE-C5DB4RE0015MCSXXX-X	1	1010840015
	5.0 m	IE-C5DB4RE0030MCSXXX-X	1	1010840030
	10.0 m	IE-C5DB4RE0050MCSXXX-X	1	1010840050
Note		IE-C5DB4RE0100MCSXXX-X	1	1010840100

Accessories

Sheathing stripper		Type	Qty.	Order No.
	For UTP and STP data cables	AM 12	1	9030060000
	For coaxial and round data cables	IE-CST	1	9204350000
Markers				
	Insertion label, yellow, 12 mm	TMH 12 MC NE GE	320	1718411687
	Insertion label, yellow, 18 mm	TMH 18 MC NE GE	320	1718431687

Note

Assembled cables

Railway cable M12

- Cat. 5
- Radox
- D-coded

M12 / M12

Plug / plug



M12		M12
1	yellow	1
2	white	2
3	orange	3
4	blue	4

M12 / M12

Plug / plug



M12		M12
1	yellow	1
2	white	2
3	orange	3
4	blue	4

Technical data

Product type	System cable
Category	Cat.5 (ISO/IEC 11801) / Cat.5e (TIA T568-B)
Shielding	SF/UTP
Version connector left / Version connector right	M12 IP 67 straight male / M12 IP 67 angled male
Cross-section	2*2*AWG 22/7 - 2*2*0.36 mm ²
Sheath diameter, max.	7.55 mm
Material sheath	Radox GKW S
Sheathing colour	Black
Insulation diameter, min. / max.	1.95 mm
Min. bending radius, repetitive	6 *diameter
Ambient temperature (operational)	-40 °C...90 °C
Installation temperature	-25 °C...90 °C
Storage temperature	-40 °C...90 °C
Abrasion resistance	very good
Halogen	halogen-free, according to IEC 60754-2
Resistance to oils	in accordance with EN 50306-3
Fire safety for railway vehicles	According to DIN 5510-2 fire safety levels 1,2,3,4, According to BS 6853, According to EN50288-2-2

Product type	System cable
Category	Cat.5 (ISO/IEC 11801) / Cat.5e (TIA T568-B)
Shielding	SF/UTP
Version connector left / Version connector right	M12 IP 67 angled male / M12 IP 67 angled male
Cross-section	2*2*AWG 22/7 - 2*2*0.36 mm ²
Sheath diameter, max.	7.55 mm
Material sheath	Radox GKW S
Sheathing colour	Black
Insulation diameter, min. / max.	1.95 mm
Min. bending radius, repetitive	6 *diameter
Ambient temperature (operational)	-40 °C...90 °C
Installation temperature	-25 °C...90 °C
Storage temperature	-40 °C...90 °C
Abrasion resistance	very good
Halogen	halogen-free, according to IEC 60754-2
Resistance to oils	in accordance with EN 50306-3
Fire safety for railway vehicles	According to DIN 5510-2 fire safety levels 1,2,3,4, According to BS 6853, According to EN50288-2-2

Product type	System cable
Category	Cat.5 (ISO/IEC 11801) / Cat.5e (TIA T568-B)
Shielding	SF/UTP
Version connector left / Version connector right	M12 IP 67 angled male / M12 IP 67 angled male
Cross-section	2*2*AWG 22/7 - 2*2*0.36 mm ²
Sheath diameter, max.	7.55 mm
Material sheath	Radox GKW S
Sheathing colour	Black
Insulation diameter, min. / max.	1.95 mm
Min. bending radius, repetitive	6 *diameter
Ambient temperature (operational)	-40 °C...90 °C
Installation temperature	-25 °C...90 °C
Storage temperature	-40 °C...90 °C
Abrasion resistance	very good
Halogen	halogen-free, according to IEC 60754-2
Resistance to oils	in accordance with EN 50306-3
Fire safety for railway vehicles	According to DIN 5510-2 fire safety levels 1,2,3,4, According to BS 6853, According to EN50288-2-2

Note

Ordering data

1.5 m
3.0 m
5.0 m
10.0 m

Note

Type	Qty.	Order No.
IE-C5DB4RE0015MCSMCA-E	1	1059940015
IE-C5DB4RE0030MCSMCA-E	1	1059940030
IE-C5DB4RE0050MCSMCA-E	1	1059940050
IE-C5DB4RE0100MCSMCA-E	1	1059940100

Type	Qty.	Order No.
IE-C5DB4RE0015MCAMCA-E	1	1059970015
IE-C5DB4RE0030MCAMCA-E	1	1059970030
IE-C5DB4RE0050MCAMCA-E	1	1059970050
IE-C5DB4RE0100MCAMCA-E	1	1059970100

Accessories

Markers

Insertion label, yellow, 12 mm
Insertion label, yellow, 18 mm
Transparent sleeves, 12-mm length
Transparent sleeves, 18-mm length

Type	Qty.	Order No.
TM-I 12 MC NE GE	320	1718411687
TM-I 18 MC NE GE	320	1718431687
TM 4/12 HF/HB	500	1719840000
TM 4/18 HF/HB	500	1719850000

Type	Qty.	Order No.
TM-I 12 MC NE GE	320	1718411687
TM-I 18 MC NE GE	320	1718431687
TM 4/12 HF/HB	500	1719840000
TM 4/18 HF/HB	500	1719850000

Note

Assembled cables - Railway cable M12

Assembled cables

Railway cable M12

- Cat. 5
- Radox
- D-coded

M12 / open

Plug / -



	M12
yellow	1
white	2
orange	3
blue	4

Technical data

Product type	System cable
Category	Cat.5 (ISO/IEC 11801) / Cat.5e (TIA T568-B)
Shielding	SF/UTP
Version connector left / Version connector right	M12 IP 67 angled male / Open
Cross-section	2*2*AWG 22/7 - 2*2*0.36 mm ²
Sheath diameter, max.	7.55 mm
Material sheath	Radox GKW S
Sheathing colour	Black
Insulation diameter, min. / max.	1.95 mm
Min. bending radius, repetitive	6 *diameter
Ambient temperature (operational)	-40 °C...90 °C
Installation temperature	-25 °C...90 °C
Storage temperature	-40 °C...90 °C
Abrasion resistance	very good
Halogen	halogen-free, according to IEC 60754-2
Resistance to oils	in accordance with EN 50306-3
Fire safety for railway vehicles	According to DIN 5510-2 fire safety levels 1,2,3,4, According to BS 6853, According to EN50288-2-2

Note

Ordering data

	1.5 m	Type	Qty.	Order No.
	3.0 m	IE-C5DB4RE0015MCAXXX-X	1	1059900015
	5.0 m	IE-C5DB4RE0030MCAXXX-X	1	1059900030
	10.0 m	IE-C5DB4RE0050MCAXXX-X	1	1059900050
		IE-C5DB4RE0100MCAXXX-X	1	1059900100
Note				

Accessories

Markers	Type	Qty.	Order No.
Insertion label, yellow, 12 mm	TM-I 12 MC NE GE	320	1718411687
Insertion label, yellow, 18 mm	TM-I 18 MC NE GE	320	1718431687
Transparent sleeves, 12-mm length	TM 4/12 HF/HB	500	1719840000
Transparent sleeves, 18-mm length	TM 4/18 HF/HB	500	1719850000

Note

Note

Assembled cables

Railway cable RW M12

- Cat. 5
- Radox
- D-coded
- RW (reduced wire): suitable for RJ45 connectors

M12 open

Plug / -



M12 - RJ45

Plug / plug



	M12
yellow	1
white	2
orange	3
blue	4

RJ45		M12
1	yellow	1
3	white	2
2	orange	3
6	blue	4

Technical data

Product type	System cable
Category	Cat.5 (ISO/IEC 11801)
Shielding	SF/UTP
Version connector left / Version connector right	M12 IP 67 straight male / Open
Cross-section	2*2*AWG 22/7 - 2*2*0.36 mm ²
Sheath diameter, max.	7 mm
Material sheath	Radox GKW S
Sheathing colour	Black
Insulation diameter	1.58 mm
Min. bending radius, repetitive	6 *diameter
Ambient temperature (operational)	-40 °C...90 °C
Storage temperature	-40 °C...90 °C
Abrasion resistance	very good
Halogen	halogen-free, according to IEC 60754-2
Resistance to oils	in accordance with EN 50306-3
Fire safety for railway vehicles	According to DIN 5510-2 fire safety levels 1,2,3,4, According to BS 6853, According to EN50288-2-2
Approvals	
Note	

Product type	System cable
Category	Cat.5 (ISO/IEC 11801)
Shielding	SF/UTP
Version connector left / Version connector right	M12 IP 67 straight male / RJ45 IP 20 tool-free
Cross-section	2*2*AWG 22/7 - 2*2*0.36 mm ²
Sheath diameter, max.	7 mm
Material sheath	Radox GKW S
Sheathing colour	Black
Insulation diameter	1.58 mm
Min. bending radius, repetitive	6 *diameter
Ambient temperature (operational)	-40 °C...90 °C
Storage temperature	-40 °C...90 °C
Abrasion resistance	very good
Halogen	halogen-free, according to IEC 60754-2
Resistance to oils	in accordance with EN 50306-3
Fire safety for railway vehicles	According to DIN 5510-2 fire safety levels 1,2,3,4, According to BS 6853, According to EN50288-2-2
Approvals	
Note	

Product type	System cable
Category	Cat.5 (ISO/IEC 11801)
Shielding	SF/UTP
Version connector left / Version connector right	M12 IP 67 straight male / RJ45 IP 20 tool-free
Cross-section	2*2*AWG 22/7 - 2*2*0.36 mm ²
Sheath diameter, max.	7 mm
Material sheath	Radox GKW S
Sheathing colour	Black
Insulation diameter	1.58 mm
Min. bending radius, repetitive	6 *diameter
Ambient temperature (operational)	-40 °C...90 °C
Storage temperature	-40 °C...90 °C
Abrasion resistance	very good
Halogen	halogen-free, according to IEC 60754-2
Resistance to oils	in accordance with EN 50306-3
Fire safety for railway vehicles	According to DIN 5510-2 fire safety levels 1,2,3,4, According to BS 6853, According to EN50288-2-2
Approvals	
Note	

Ordering data

	4.0 m
	5.0 m
	10.0 m
Note	

Type	Qty.	Order No.
IE-C5DB4WE0050MCSXXX-E	1	1269740050
IE-C5DB4WE0100MCSXXX-E	1	1269740100

Type	Qty.	Order No.
IE-C5DB4WE0040MCSA20-E	1	1220310040

Accessories

Sheathing stripper	
	For UTP and STP data cables
	For coaxial and round data cables
Markers	
	Transparent sleeves. 12-mm length
	Transparent sleeves. 18-mm length

Type	Qty.	Order No.
AM 12	1	9030060000
IE-CST	1	9204350000
TM 4/12 HF/HB	500	1719840000
TM 4/18 HF/HB	500	1719850000

Type	Qty.	Order No.
TM 4/12 HF/HB	500	1719840000
TM 4/18 HF/HB	500	1719850000

Note	
------	--

Note	
------	--

Note	
------	--

Assembled cables – Railway cable RJ45

Assembled cables

Railway cable RW RJ45 - RJ45

- Cat. 5
- Radox
- RW (reduced wire)

RJ45 - RJ45

Plug / plug



M12		M12
1	yellow	1
2	white	2
3	orange	3
4	blue	4

Technical data

Product type
Category
Shielding
Version connector left / Version connector right
Cross-section
Sheath diameter, max.
Material sheath
Sheathing colour
Insulation diameter
Min. bending radius, repetitive
Ambient temperature (operational)
Storage temperature
Abrasion resistance
Halogen
Resistance to oils
Fire safety for railway vehicles

System cable
Cat.5 (ISO/IEC 11801)
SF/UTP
RJ45 IP 20 tool-free / RJ45 IP 20 tool-free
2*2*AWG 22/7 - 2*2*0.36 mm ²
7 mm
Radox GKW S
Black
1.58 mm
6 *diameter
-40 °C...90 °C
-40 °C...90 °C
very good
halogen-free, according to IEC 60754-2
in accordance with EN 50306-3
According to DIN 5510-2 fire safety levels 1,2,3,4, According to BS 6853, According to EN50288-2-2

Approvals

Note

Ordering data

1.0 m
2.0 m
3.0 m
5.0 m
10.0 m
20.0 m

Note

Type	Qty.	Order No.
IE-C5DB4WE0010A20A20-E	1	1421710010
IE-C5DB4WE0020A20A20-E	1	1421710020
IE-C5DB4WE0030A20A20-E	1	1421710030
IE-C5DB4WE0050A20A20-E	1	1421710050
IE-C5DB4WE0100A20A20-E	1	1421710100
IE-C5DB4WE0200A20A20-E	1	1421710200

Accessories

Markers	
	Transparent sleeves. 12-mm length
	Transparent sleeves. 18-mm length

Type	Qty.	Order No.
TM 4/12 HF/HB	500	1719840000
TM 4/18 HF/HB	500	1719850000

Note

Assembled cables
USB cable

USB A - USB A



USB A - USB Micro



Technical data

Sheathing colour
Material sheath
Ambient temperature (operational)
Note

Black
PVC
-15 °C...80 °C

PVC
-15 °C...80 °C

Ordering data

	0.5 m
	1.0 m
	1.5 m
	1.8 m
	3.0 m
Note	

Type	Qty.	Order No.
IE-USB-A-A-0.5M	1	1993550005
IE-USB-A-A-1.0M	1	1993550010
IE-USB-A-A-1.5M	1	1993550015
IE-USB-A-A-1.8M	1	1993550018
IE-USB-A-A-3.0M	1	1993550030

Type	Qty.	Order No.
IE-USB-A-MICRO-1.8M	1	1487980000

Accessories

--

Type	Qty.	Order No.

Type	Qty.	Order No.

Note

--

--

Fibre-optic cabling solutions

Overview

Fibre-optic cabling solutions	Overview - Fibre-optic cables	M.2
	Product configurator - Fibre-optic cables	M.4
	Raw cables - FO connection cable / dragline cable	M.5
	Assembled cables - FO patch cable	M.7
	Assembled cables - FO PROFINET cable	M.12
	Assembled cables - FO dragline cable	M.13

Overview – Fibre-optic cables

First choice for industry

Fibre-optic cables are the best option for working in harsh industrial environments, especially if you:

- Need long transmission paths (up to 120 km!)
- Need to take account of EMC issues
- Must ensure electrical isolation in the case of potential differences

Raw cables

Industrial fibre-optic dragline cable



For flexible installations in and around machinery and plants – for harsh, industrial surroundings, dragline cable compatible

- Polymer optic fibre (POF)
- Multimode glass fibre
- Breakout cable
- Zipcord cable
- Cable by the metre for assembling your own connecting cables

Assembled cables

Industrial FO patch cables



...for use in industrial switching cabinets or junction boxes

- Multimode glass fibre
- Zipcord cable

Industrial FO adapter cables



...for linking ST and SC connections

- Multimode glass fibre
- Zipcord cable

Industrial fibre-optic dragline cable



...for flexible installations in and around machinery and plants – for harsh, industrial surroundings, dragline cable compatible

- Multimode fibre-optic
- Breakout cable
- Pre-assembled cable

Ordering data for Fibre-optic cables (FO), sold by the metre

Type	Breakout/ Zipcord	Plug-in connector		Length	Metre goods					
		left	right							
GOF dragline, standard temperature range										
IE-FM5D2UE-MW	Breakout	-	-	8946000000						
IE-FM6D2UE-MW	Breakout	-	-	8956060000						
GOF dragline, extended temperature range										
IE-FM5C2UE-MW	Breakout	-	-	8956070000						
IE-FM6C2UE-MW	Breakout	-	-	8956050000						
POF										
IE-FPOZ2EE-MW	Zipcord	-	-	1242820000						
IE-FPOD2UE-MW	Breakout, black	-	-	1172280000						
IE-FPOD2UG-MW	Breakout, green	-	-	1398770000						

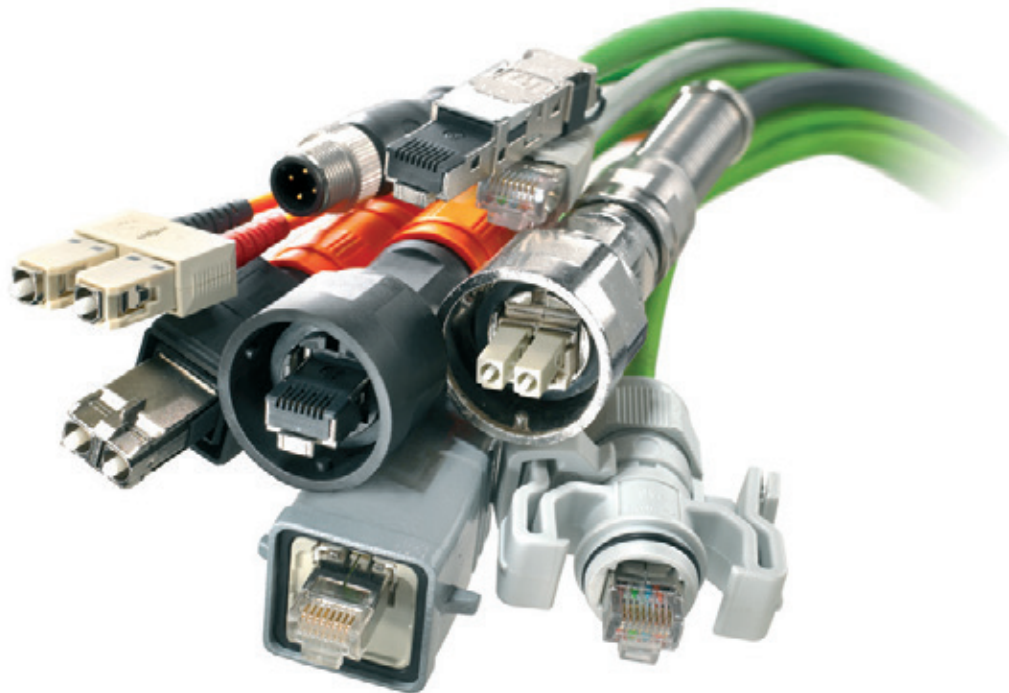

Configurators for fibre-optic cables

Tailor-made connections

The cable configurator in Weidmüller’s online catalogue makes it possible for you to create a fully-assembled cable adapted to your requirements and specifications.

You then have the choice of configuring a cable which is identical on both ends, or with two different mating profiles, or with one end left open.

A variety of plug types in the following protective classes are available:

IP 20

- SCRJ
- ST
- LC Duplex
- SC duplex

IP 67

- Variant 1, metal with SC- or LC-Duplex plugs
- Variant 4, plastic with SC- or LC-Duplex plugs
- Additional housing variants to follow shortly.
- Variant 14, metal with SC or LC Duplex plugs



When selecting the cable, the following types are available:

- Zipcord, inner conductor G50 µm/125 µm and G62.5 µm/125 µm with PVC sheath
- Breakout, interior wire G50 µm/125 µm and G62.5 µm/125 µm with PVC sheath
- Breakout dragline cable, inner conductor G50 µm/125 µm and G62.5 µm/125 µm with PUR sheath.
- Zipcord inner conductor POF 980/1000 µm with PE sheathing

The cable length can also be customised:

- From 0.3 m to 9.9 m, in 0.1 m steps
- From 10 m to 9999 m, in 1 m steps

The cable configurator can also automatically create technical data sheets for all of your customised cable variants.

All of your customised cable selections can be sent to Weidmüller using the “request list”. You will then quickly receive a price proposal for the cables from your local Weidmüller representative.

Raw cables

- Multimode glass optical fibre
- Customisable

Dragline cable

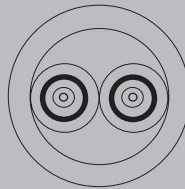

Dragline cable

Extended temperature range

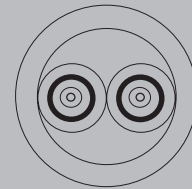

Technical data

Product type
Cable layout
Sheath diameter
Material sheath
Sheathing colour
Min. bending radius, repetitive
Min. bending radius, once only
Bending cycles
Ambient temperature (operational)
Installation temperature
Storage temperature
Approvals

Note

Dragline cable
Break-out dragline
6 mm
PUR
Black
77 mm
25 mm
100,000
-40 °C...80 °C
-20 °C...60 °C
-40 °C...80 °C

Dragline cable
Break-out dragline
7.5-8 mm
PUR
Black
70 mm
25 mm
100,000
-40 °C...85 °C
-55 °C...60 °C
-55 °C...85 °C

Ordering data

Core 62.5 µm, OM1	Cut to metre starting at 50.0 m
--------------------------	---------------------------------

Core 50 µm, OM2	Cut to metre starting at 50.0 m
------------------------	---------------------------------

Note

Type	Qty.	Order No.
IE-FM6D2UE-MW		8956060000

IE-FM5D2UE-MW		8946000000
---------------	--	------------

Order example, for cut cable: 150 x „article number“ = 150 m on drum

Type	Qty.	Order No.
IE-FM6C2UE-MW		8956050000

IE-FM5C2UE-MW		8956070000
---------------	--	------------

Order example, for cut cable: 150 x „article number“ = 150 m on drum

Accessories

Markers
Insertion label, yellow, 12 mm
Insertion label, yellow, 18 mm
Transparent sleeves, 12-mm length
Transparent sleeves, 18-mm length
Wire and cable marker, ø 4.7 - 7.4 mm
Wire and cable marker, ø 5.8 - 7.8 mm

Tools

	Crimping pliers GOF LC
	Crimping pliers GOF SC
	Fibre-optic tool case

Type	Qty.	Order No.
TM-I 12 MC NE GE	320	1718411687
TM-I 18 MC NE GE	320	1718431687
TM 4/12 HF/HB	500	1719840000
TM 4/18 HF/HB	500	1719850000
VT SF 5/21 MC NE WS VO	160	1689470001
VT SF 6/21 MC NE WS VO	160	1730560001

IE-CT-LC-GOF	1	9205330000
IE-CT-SC-GOF	1	9205320000
IE-CTC-SCST-GOF	1	1032030000

Type	Qty.	Order No.
TM-I 12 MC NE GE	320	1718411687
TM-I 18 MC NE GE	320	1718431687
TM 4/12 HF/HB	500	1719840000
TM 4/18 HF/HB	500	1719850000
VT SF 5/21 MC NE WS VO	160	1689470001
VT SF 6/21 MC NE WS VO	160	1730560001

IE-CT-LC-GOF	1	9205330000
IE-CT-SC-GOF	1	9205320000
IE-CTC-SCST-GOF	1	1032030000

Note

Raw cables – FO connection cable / dragline cable

Raw cables

- Polymer optical fibre
- Customisable

Zipcord

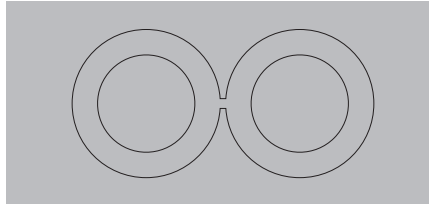

Breakout

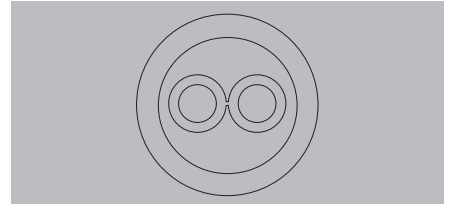

Technical data

Product type
Cable layout
Sheath diameter
Material sheath
Insulation
Min. bending radius, repetitive
Min. bending radius, once only
Bending cycles
Ambient temperature (operational)
Fibre type
Bandwidth
Attenuation
Core diameter
Installation temperature
Storage temperature
Halogen
Approvals

Connecting cables
ZIPCORD
2.2*4.5 mm
PE
25 mm
25 mm
10.000
-55 °C...85 °C
POF
≥ 100 MHz*km at 650 nm
≤ 160 dB/km at 650 nm
980 µm
-5 °C...50 °C
-55 °C...85 °C
No

Dragline cable
Break-out dragline
7,5 mm
PUR
60 mm
25 mm
100,000
-40 °C...85 °C
POF
> 35 MHz*100 m at 650 nm
≤ 160 dB/km at 650 nm
980 µm
-30 °C...60 °C
-40 °C...85 °C
No

Note

Ordering data

POF 980/1000 µm
Cut to metre starting at 50.0 m. black
Cut to metre starting at 50.0 m. green

Note

Type	Qty.	Order No.
IE-FPOZ2EE-MW		1242820000

Order example, for cut cable: 150 x „article number“ = 150 m on drum

Type	Qty.	Order No.
IE-FPOD2UE-MW		1172280000
IE-FPOD2UG-MW		1398770000

Order example, for cut cable: 150 x „article number“ = 150 m on drum

Accessories

Markers
Insertion label. yellow. 12 mm
Insertion label. yellow. 18 mm
Transparent sleeves. 12-mm length
Transparent sleeves. 18-mm length
Wire and cable marker. ø 4.7 - 7.4 mm
Wire and cable marker. ø 5.8 - 7.8 mm
Tools
Crimping tool POF
POF tool set

Type	Qty.	Order No.
TM-H 12 MC NE GE	320	1718411687
TM-H 18 MC NE GE	320	1718431687
TM 4/12 HF/HB	500	1719840000
TM 4/18 HF/HB	500	1719850000
VT SF 5/21 MC NE WS VO	160	1689470001
VT SF 6/21 MC NE WS VO	160	1730560001
HTX-IE-POF	1	1208870000
TOOL SET IE-POF	1	1208930000

Type	Qty.	Order No.
TM-H 12 MC NE GE	320	1718411687
TM-H 18 MC NE GE	320	1718431687
TM 4/12 HF/HB	500	1719840000
TM 4/18 HF/HB	500	1719850000
VT SF 5/21 MC NE WS VO	160	1689470001
VT SF 6/21 MC NE WS VO	160	1730560001
HTX-IE-POF	1	1208870000
TOOL SET IE-POF	1	1208930000

Note

Assembled cables

CabinetLine FO patch cable

- Singlemode glass optical fibre
- LSZH outer cladding

LC-Duplex / LC-Duplex

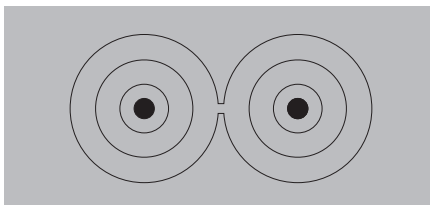

Technical data

Product type
Cable layout
Sheath diameter
Material sheath
Sheathing colour
Ambient temperature (operational)
Installation temperature
Storage temperature
Approvals
Note

Patch cable, duplex clip included
ZIPCORD
2.0 * 4.1 mm
LSZH
Yellow
-20 °C...70 °C
Note

Ordering data

Core 9 µm. OS2
0.5 m
1.0 m
2.0 m
3.0 m
5.0 m
10.0 m
Note

Type	Qty.	Order No.
IE-FSMZ2LY0005DLDO-X	1	1433950005
IE-FSMZ2LY0001MLDO-X	1	1433950010
IE-FSMZ2LY0002MLDO-X	1	1433950020
IE-FSMZ2LY0003MLDO-X	1	1433950030
IE-FSMZ2LY0005MLDO-X	1	1433950050
IE-FSMZ2LY0010MLDO-X	1	1433950100

Accessories

Markers
Wire and cable marker. ø 4.7 - 7.4 mm
Wire and cable marker. ø 5.8 - 7.8 mm

Type	Qty.	Order No.
VT SF 5/21 MC NE WS V0	160	1689470001
VT SF 6/21 MC NE WS V0	160	1730560001

Note

--



Assembled cable
FO patch cable

- Multimode glass optical fibre
- PVC outer cladding

ST / SC-Duplex

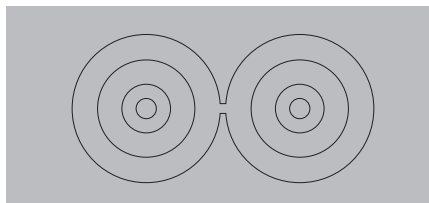

LC-Duplex / LC-Duplex

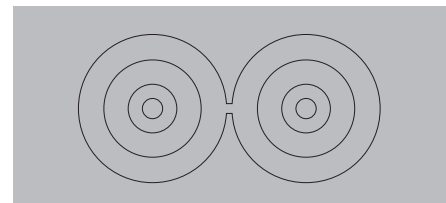

Technical data

Product type	Pre-assembled patch cable, crossover
Cable layout	ZIPCORD
Sheath diameter	3*6 mm
Material sheath	PVC
Sheathing colour	Orange
Ambient temperature (operational)	-5 °C...75 °C
Installation temperature	-5 °C...50 °C
Storage temperature	-25 °C...75 °C
Approvals	
Note	

Product type	Pre-assembled patch cable, crossover
Cable layout	ZIPCORD
Sheath diameter	3*6 mm
Material sheath	PVC
Sheathing colour	Orange
Ambient temperature (operational)	-5 °C...75 °C
Installation temperature	-5 °C...50 °C
Storage temperature	-25 °C...75 °C
Approvals	
Note	

Product type	Pre-assembled patch cable, crossover
Cable layout	ZIPCORD
Sheath diameter	3*6 mm
Material sheath	PVC
Sheathing colour	Orange
Ambient temperature (operational)	-5 °C...75 °C
Installation temperature	-5 °C...50 °C
Storage temperature	-25 °C...75 °C
Approvals	
Note	

Ordering data

Core 62.5 µm, OM1	
	1.0 m
	2.0 m
Core 50 µm, OM2	
	1.0 m
	2.0 m
	5.0 m
	10.0 m
Note	

Type	Qty.	Order No.
IE-FM6Z2V00002MSTOSDOX	1	8813400000
IE-FM5Z2V00002MSTOSDOX	1	8813390000

Type	Qty.	Order No.
IE-FM6Z2V00001MLDOLD0X	1	1296450000
IE-FM5Z2V00001MLDOLD0X	1	1276880000
IE-FM5Z2V00002MLDOLD0X	1	1062570000
IE-FM5Z2V00005MLDOLD0X	1	1062550000
IE-FM5Z2V00010MLDOLD0X	1	1062580000

Accessories

Markers	
	Wire and cable marker. ø 4.7 - 7.4 mm
	Wire and cable marker. ø 5.8 - 7.8 mm

Type	Qty.	Order No.
VT SF 5/21 MC NE WS V0	160	1689470001
VT SF 6/21 MC NE WS V0	160	1730560001

Type	Qty.	Order No.
VT SF 5/21 MC NE WS V0	160	1689470001
VT SF 6/21 MC NE WS V0	160	1730560001

Note	
------	--

Note	
------	--

Note	
------	--

Assembled cables - FO PROFINET cable

**Assembled cable
FO patch cable PROFINET**

- Polymer optical fibre

SC-RJ / SC-RJ

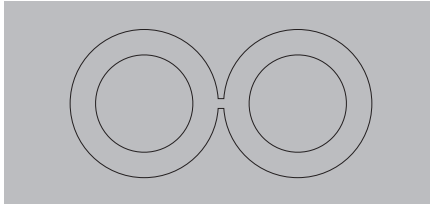
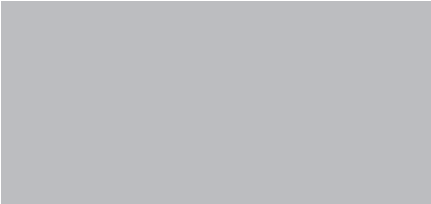

Technical data

Product type	Connecting cables
Version connector left / Version connector right	SCRJ IP 20 / SCRJ IP 20
Cable layout	ZIPCORD
Sheath diameter	2.2*4.5 mm
Insulation	PE
Sheathing colour	Black
Fibre type	POF
Core diameter	980 µm
Ambient temperature (operational)	-20 °C...80 °C
Attenuation	≤ 160 dB/km at 650 nm
Insertion loss	≤ 1.0 dB
Bandwidth	≥ 100 MHz*km at 650 nm
Halogen	No
Approvals	

Product type	Connecting cables
Version connector left / Version connector right	SCRJ IP 20 / SCRJ IP 20
Cable layout	ZIPCORD
Sheath diameter	2.2*4.5 mm
Insulation	PE
Sheathing colour	Black
Fibre type	POF
Core diameter	980 µm
Ambient temperature (operational)	-20 °C...80 °C
Attenuation	≤ 160 dB/km at 650 nm
Insertion loss	≤ 1.0 dB
Bandwidth	≥ 100 MHz*km at 650 nm
Halogen	No
Approvals	

Note

Note

Ordering data

POF 980/1000 µm	
	1.0 m
	3.0 m
	5.0 m
	10.0 m
	20.0 m

Type	Qty.	Order No.
IE-FPOZ2EE0001MSJOSJO-X	1	1273430010
IE-FPOZ2EE0003MSJOSJO-X	1	1273430030
IE-FPOZ2EE0005MSJOSJO-X	1	1273430050
IE-FPOZ2EE0010MSJOSJO-X	1	1273430100
IE-FPOZ2EE0020MSJOSJO-X	1	1273430200

Note

Note

Accessories

Markers	
	Wire and cable marker. ø 4.7 - 7.4 mm
	Wire and cable marker. ø 5.8 - 7.8 mm

Type	Qty.	Order No.
VT SF 5/21 MC NE WS V0	160	1689470001
VT SF 6/21 MC NE WS V0	160	1730560001

Note

Note

Assembled cables

FO dragline cable

- Multimode glass optical fibre

LC-Duplex / LC-Duplex

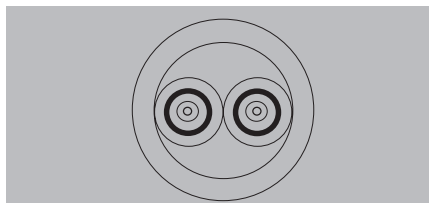

Technical data

Product type
Version connector left / Version connector right
Cable layout
Sheath diameter
Material sheath
Sheathing colour
Ambient temperature (operational)
Installation temperature
Storage temperature
Approvals

Dragline cable
LC-Duplex IP 20 / LC-Duplex IP 20
Break-out dragline
6 mm
PUR
Black
-40 °C...80 °C
-20 °C...60 °C
-40 °C...80 °C

Note

Ordering data

Core 62.5 µm, OM1	
	5.0 m
	20.0 m
	50.0 m
Core 50 µm, OM2	
	10.0 m
	50.0 m
	100.0 m

Type	Qty.	Order No.
IE-FM6D2UE0005MLDOLD0X	1	1220930000
IE-FM6D2UE0020MLDOLD0X	1	1174830000
IE-FM6D2UE0050MLDOLD0X	1	8993220000
IE-FM5D2UE0010MLDOLD0X	1	8979020000
IE-FM5D2UE0050MLDOLD0X	1	8979040000
IE-FM5D2UE0100MLDOLD0X	1	8979030000

Note

Accessories

Markers	
	Wire and cable marker. ø 4.7 - 7.4 mm
	Wire and cable marker. ø 5.8 - 7.8 mm

Type	Qty.	Order No.
VT SF 5/21 MC NE WS V0	160	1689470001
VT SF 6/21 MC NE WS V0	160	1730560001

Note

Assembled cables - FO dragline cable

**Assembled cable
FO dragline cable**

- Multimode glass optical fibre

SC-Duplex / SC-Duplex

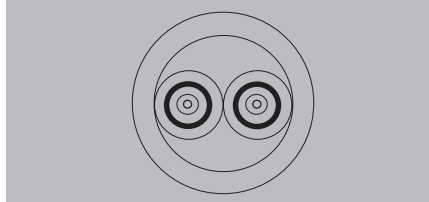

ST / ST

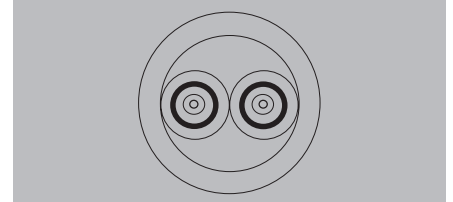

Technical data

Product type
Cable layout
Sheath diameter
Material sheath
Sheathing colour
Ambient temperature (operational)
Installation temperature
Storage temperature
Approvals

Dragline cable
Break-out dragline
6 mm
PUR
Black
-40 °C...80 °C
-20 °C...60 °C
-40 °C...80 °C

Dragline cable
Break-out dragline
6 mm
PUR
Black
-40 °C...80 °C
-20 °C...60 °C
-40 °C...80 °C

Note

Ordering data

Core 62.5 µm, OM1	
1.0 m	
3.0 m	
5.0 m	
10.0 m	
100.0 m	
Core 50 µm, OM2	
1.0 m	
3.0 m	
5.0 m	
10.0 m	
50.0 m	
100.0 m	

Type	Qty.	Order No.
IE-FM6D2UE0001MSDOSDOX	1	8876440010
IE-FM6D2UE0003MSDOSDOX	1	8876440030
IE-FM6D2UE0005MSDOSDOX	1	8876440050
IE-FM6D2UE0010MSDOSDOX	1	8876440100
IE-FM5D2UE0001MSDOSDOX	1	8876430010
IE-FM5D2UE0003MSDOSDOX	1	8876430030
IE-FM5D2UE0005MSDOSDOX	1	8876430050
IE-FM5D2UE0010MSDOSDOX	1	8876430100
IE-FM5D2UE0100MSDOSDOX	1	8876431000

Type	Qty.	Order No.
IE-FM6D2UE0001MSTOSTOX	1	8876460010
IE-FM6D2UE0003MSTOSTOX	1	8876460030
IE-FM6D2UE0005MSTOSTOX	1	8876460050
IE-FM6D2UE0010MSTOSTOX	1	8876460100
IE-FM5D2UE0001MSTOSTOX	1	8876450010
IE-FM5D2UE0003MSTOSTOX	1	8876450030
IE-FM5D2UE0005MSTOSTOX	1	8876450050
IE-FM5D2UE0010MSTOSTOX	1	8876450100
IE-FM5D2UE0050MSTOSTOX	1	8876450500
IE-FM5D2UE0100MSTOSTOX	1	8876451000

Note

Accessories

Markers	
Wire and cable marker. ø 4.7 - 7.4 mm	
Wire and cable marker. ø 5.8 - 7.8 mm	

Type	Qty.	Order No.
VT SF 5/21 MC NE WS V0	160	1689470001
VT SF 6/21 MC NE WS V0	160	1730560001

Type	Qty.	Order No.
VT SF 5/21 MC NE WS V0	160	1689470001
VT SF 6/21 MC NE WS V0	160	1730560001

Note

Assembled cables

FO dragline cable with extended temperature range

- Multimode glass optical fibre

SC-Duplex IP 67

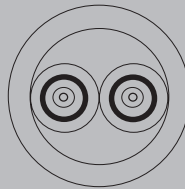

Technical data

Product type
Cable layout
Version connector left / Version connector right
Sheath diameter
Material sheath
Sheathing colour
Fibre type
Bandwidth
Attenuation
Ambient temperature (operational)
Installation temperature
Storage temperature
Approvals

Dragline cable
Break-out dragline
SC IP 67 bayonet V01 metal / SC IP 67 bayonet V01 metal
7.5-8 mm
PUR
Black
GOF, Multimode, OM1
200 MHz*km at 850 nm, 500 MHz*km at 1300 nm
2.7 dB/km at 850 nm, ≤ 0.5 dB/km at 1300 nm
-40 °C...85 °C
-55 °C...60 °C
-55 °C...85 °C

Note

Ordering data

Core 62.5 µm. OM1	
100.0 m	
180.0 m	
200.0 m	
250.0 m	
300.0 m	
350.0 m	
500.0 m	

Type	Qty.	Order No.
IE-FM6C2UE0100MSD1SD1X	1	1318011000
IE-FM6C2UE0180MSD1SD1X	1	1318011800
IE-FM6C2UE0200MSD1SD1X	1	1318012000
IE-FM6C2UE0250MSD1SD1X	1	1318012500
IE-FM6C2UE0300MSD1SD1X	1	1318013000
IE-FM6C2UE0350MSD1SD1X	1	1318013500
IE-FM6C2UE0500MSD1SD1X	1	1318015000

Note

Accessories

Markers	
Wire and cable marker. ø 4.7 - 7.4 mm	
Wire and cable marker. ø 5.8 - 7.8 mm	

Type	Qty.	Order No.
VT SF 5/21 MC NE WS V0	160	1689470001
VT SF 6/21 MC NE WS V0	160	1730560001

Note

Assembled cables - FO dragline cable

Assembled cables

FO dragline cable

- Singlemode glass optical fibre

SC-Duplex IP 67

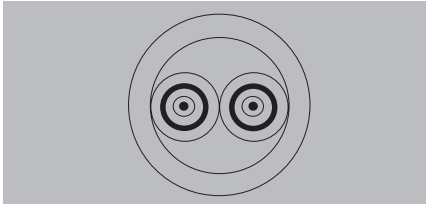
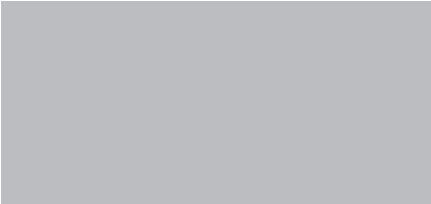

Technical data

Product type
Cable layout
Version connector left / Version connector right
Sheath diameter
Material sheath
Sheathing colour
Fibre type
Bandwidth
Insertion loss
Attenuation
Ambient temperature (operational)
Installation temperature
Storage temperature
Approvals

Dragline cable
Break-out dragline
SC IP 67 PushPull V14 metal / SC IP 67 PushPull V14 metal
6 mm
PUR
Black
Singlemode, OS 2
≤ 0.5 dB
≤0.4 dB/km at 1310 nm
-40 °C...80 °C
-20 °C...60 °C
-40 °C...80 °C

Note

Note

Ordering data

Core 9 µm. OS2
5.0 m
20.0 m
25.0 m
40.0 m

Type	Qty.	Order No.
IE-FSMD2UE0005MSDESDEX	1	1449420050
IE-FSMD2UE0020MSDESDEX	1	1449420200
IE-FSMD2UE0025MSDESDEX	1	1449420250
IE-FSMD2UE0040MSDESDEX	1	1449420400

Note

Accessories

Markers
Wire and cable marker. ø 4.7 - 7.4 mm
Wire and cable marker. ø 5.8 - 7.8 mm

Type	Qty.	Order No.
VT SF 5/21 MC NE WS V0	160	1689470001
VT SF 6/21 MC NE WS V0	160	1730560001

Note

Note

Passive components

Overview of accessories

Accessories – Passive components	Introduction	N.2
	Cable connector	N.3
	Copper cabling tools	N.4
	Fibre-optic cabling tools	N10
	General tools	N.16
	Cabtite cable entry system	N.18
	Protective caps	N.21
	Inkjet printer	N.22
	Markers for cables and STEADYTEC®	N.24
	Surge protection for data interfaces	N.25

Overview of accessories

Everything from a single source

Cable connector



Connection, repair or extension of Industrial Ethernet cables to Cat.7_A

- fieldattachable with IDC connection technology
- Specified for class F_A
- IP 67

Cabtite



System-based cable entry

- Cable entry strips
- Cable grommets

Copper cabling tools



For assembling

- RJ45 crimp
- Hybrid insert

for stripping
to test the wiring

Protective caps

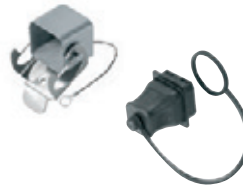

to protect all IE-LINE connectors with **STEADYTEC**[®] technology

Fibre-optic cabling tools



For assembling

- SC-GOF
- ST-GOF

Marker



... for identifying conductors, plugs and devices

- Line markers
- Housing and plug marker

General tools



... for pressing conductors into IDC terminals and pressing RJ45 contacts

- Indentation tool
- Pressing tool

Surge protection for data interfaces



For the protection of Cat. 5 and Cat. 6 data lines - also in PoE and PoE + applications

Cable connector class 7

Cable connector

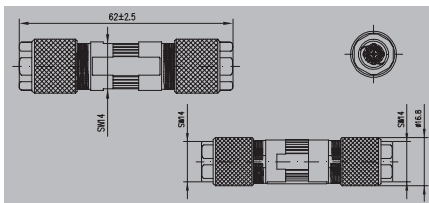

Technical data

Category	
Protection degree	
Connection 1 / 2	
Housing main material	
Ambient temperature (operational)	
Current-carrying capacity at 50 °C	
Rated voltage	
Insulation resistance	
Shielding	
Connection diameter, flexible, min. / max.	
Connection cross-section, flexible, min. / max.	
Connection diameter, solid, min. / max.	
Connection cross-section, solid, min. / max.	
Insulation cross-section, max.	
Sheath diameter min. / max.	
Approvals	

Class F _A (ISO/IEC11801 2011) with cat. 7 _A Cable
IP 67
Insulation displacement technology / Insulation displacement technology
Zinc diecast
-40 °C...85 °C
0.5 A @ 40 °C
63 V
100 MΩ
360° all-round enclosure
0.48 mm / 0.76 mm
AWG 26 / AWG 22
0.4 mm / 0.64 mm
AWG 24 / AWG 22
1.6 mm
5 mm / 9.7 mm

Note

Ordering data

Note

Type	Qty.	Order No.
IE-CC-8W-FA-IP67	1	1499940000

Accessories

--

Type	Qty.	Order No.

Note

Copper cabling tools

Stripping tools

IE-CST

1- and 2- step stripping in one operation



Stripping tool for round (shielded) data cables of Ø 2.5...8 mm

- Specially designed for Ethernet cables
- Strips sheathing and cuts shield in one operation
- Blue blade cartridge included in delivery

AM 12

For UTP and STP data cables



- Cutting of UTP and STP data cables and other flexible copper cables with a diameter of up to 4 mm² (~AWG11)
- Stripping of the outer insulations of UTP and STP data cables and other round cables with Ø 0.5 ... 12.5 mm
- No damage to the shielding or conductor due to adjustable stripping blade
- Length gauge for repeated stripping lengths

Technical data

Max. cutting performance copper cable	
Cable model	
Conductor cross-section	AWG
Conductor diameter	mm
Adjustable depth of cut	mm
Cutting performance	
Non-shielded & shielded data cables	mm
Flexible copper cable	mm ²
Tool data	
Length	mm
Weight	g
Note	

IE-CST		
coaxial & round data cables		
		2.5 ... 8
		100
		85
Note		

AM 12		
UTP and STP data cables		
		0.5...12.5
		adjustable
		8
		4
		97
		36
Note		

Ordering data

Type	Qty.	Order No.
IE-CST	1	9204350000
Note		

Type	Qty.	Order No.
IE-CST	1	9204350000
Note		

Type	Qty.	Order No.
AM 12	1	9030060000
Note		

Accessories

Type	Qty.	Order No.
Spare cutter cassette	1	9032020000
Note		

Type	Qty.	Order No.
Spare cutter cassette	1	9032020000
Note		

Type	Qty.	Order No.
Note		

N

Pressing tools

- Press (punch-down) tool for Ethernet connectors
- Ratchet for precise crimping
- Release option in the event of incorrect operation

TT 8 RS MP 8



For 8-pole shielded RJ45 plug

- AWG 27...24



Technical data

Description of contact	
No. of poles	
Tool data	
Length	mm
Weight	g
Note	

TT 8 RS MP 8		
8		
255		
1251		
Note		

Ordering data

Version
Note

Type	Qty.	Order No.
TT 8 RS MP 8	1	9202800000
Note		



Copper cabling tools

Pressing tools

- Optional crimping tool for Ethernet connectors to facilitate the joining of the upper and lower parts of the RJ45 plug/module

PWZ RJ45

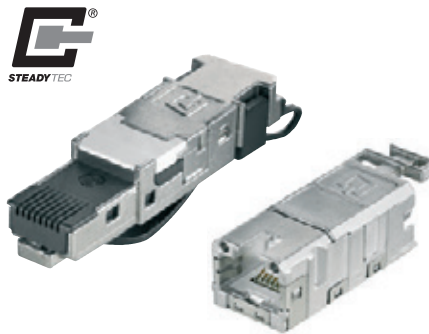

Technical data

Tool data	PWZ RJ45
Weight	367 g

Note	
-------------	--

Ordering data

Version	
----------------	--

Type	Qty.	Order No.
PWZ RJ45	1	1118040000

Note	
-------------	--

Cable Tester

Test devices for testing Ethernet cables, including remote box

LAN USB TESTER



- Indication of connection errors:
 Connection error
 Interrupt
 Short-circuit
 Permutation
- Network cable tester for LAN and USB connections



IE-CT



- Indication of connection errors:
 Connection error
 Interrupt
 Short-circuit
 Permutation
 Wire mix-up (split pair)
 External voltage
- External voltage resistance: 80 V AC / DC

Technical data

Display	
Supply	
Type of connection	
Remote box dimensions	
Remote box weight	
Length / Width / Height	mm
Weight	
Note	

LED
9 V battery
RJ45, USB A, USB B
65 x 28 x 27 mm
30 g
135 / 65 / 27
174 g

7-segment display
9 V battery
RJ45
30 x 68 x 23 mm
31 g
140 / 70 / 36
185 g

Ordering data

Version
Note

Type	Qty.	Order No.
LAN USB TESTER	1	9205400000
Battery, accessories and bag included in delivery.		

Type	Qty.	Order No.
IE-CT	1	8808420000
Battery, accessories and bag included in delivery. Further test boxes on request		

Copper cabling tools

Cutting tools

- The cutting blade design for different cable sizes increases the quality of the cuts for smaller cross-sections
- Not suitable for steel wires, steel-armoured cables, aluminium alloys and hard-drawn copper conductors!
- Cutting without deformation of the conductor
- Do not cut live conductors
- Individually tested protective insulation, 1000V, VDE and GS tested in accordance with EN/IEC 60900
- Optimised handle ergonomics
- Minimal hand force required

KT 8



 max. 8 mm

 max. 16 mm²

 max. 16 mm²

 max. 16 mm²

Technical data

Max. cutting performance, copper cable	
Copper cable - solid, max.	mm ² /-
Copper cable - stranded, max.	mm ² /-
Copper cable - flexible, max.	mm ² /-
Copper cable, max. diameter	mm
Max. cutting performance, aluminium cable	
Stranded aluminium cable, max (mm ²)	mm ² /-
Stranded aluminium cable, max. diameter	mm
Single-core aluminium cable, max.(mm ²)	mm ²
Data / telephone / control cable	
Data / telephone / control cable, max. Ø	mm
Tool data	
Length / Width / Height	mm
Weight	g
Note	

KT8	
16	
16 / 6	
16 / 6	
8	
16 / 6	
8	
16	
8	
185 / 65,5 / 30	
180	
Tool closed	

Ordering data

Version
Note

Type	Qty.	Order No.
KT 8	1	9002650000
Note		

SEE ESD 120**Electronic ESD diagonal-cutting pliers with pointed head**

- Hard wire (spring wire or steel nails):
0.4 mm/AWG 26
- Semi-hard wire (iron or nails):
1.0 mm/AWG 18
- Soft wire (copper or aluminium):
1.5 mm/AWG 15

Ordering data

Type	Qty.	Order No.
SEE ESD 120	1	9205130000

Technical data

Weight 90 g

**SEE ESD 125****Electronic ESD diagonal-cutting pliers with oval head**

- Semi-hard wire (iron or nails):
0.8 mm/AWG 20
- Soft wire (copper or aluminium):
1.5 mm/AWG 15

Ordering data

Type	Qty.	Order No.
SEE ESD 125	1	9204750000

Technical data

Weight 90 g

**FZE ESD 130****Electronic ESD flat-nosed pliers****Ordering data**

Type	Qty.	Order No.
FZE ESD 130	1	9204760000

Technical data

Weight 90 g

**SZE ESD 130****Electronic ESD Snipe-nosed pliers****Ordering data**

Type	Qty.	Order No.
SZE ESD 130	1	9204770000

Technical data

Weight 90 g

**SVSE ESD 130****Electronic ESD angle-cutting pliers**

- Hard wire (spring wire or steel nails):
0.6 mm/AWG 22
- Semi-hard wire (iron or nails):
1.0 mm/AWG 18
- Soft wire (copper or aluminium):
1.2 mm/AWG 16

Ordering data

Type	Qty.	Order No.
SVSE ESD 130	1	9205140000

Technical data

Weight 90 g

**SUPER CUT****Electronic diagonal-cutting pliers**

- Soft wire (copper or aluminium):
1.2 mm/AWG 16

Ordering data

Type	Qty.	Order No.
SUPER CUT	1	9205150000

Technical data

Weight 78 g

**KOF SET ESD****Electronic ESD case set**

Contents:

- Diagonal-cutting pliers
- Snipe-nosed pliers
- Flat-nose pliers
- Angle-cutting pliers

Ordering data

Type	Qty.	Order No.
KOF SET ESD	1	9205210000

Technical data

Weight 547 g



Fibre-optic cabling tools

Crimping tools

Cutting, stripping and crimping tools for processing POF fibres in compliance with IEC 60793-2 A4A fibres (1000 µm/980 µm POF)

- Multifunction tool for POF fibres
- Processing the duplex POF fibres
- Stripping tool for processing POF fibres and cables
- The new set of blades for POF cables makes stripping the outer covering and the POF fibres simple
- Cable shears specially designed for aramid fibres
- Only for cutting aramid fibres (strain relief in fibre-optic cables)

Tool-Set IE-POF



Contents:

- Assortment case PSC 80
- Kevlar scissors for aramid fibres
- Multifunction tool HTX-IE-POF
- Stripping tool multi-stripax® IE-POF

multi-stripax® POF

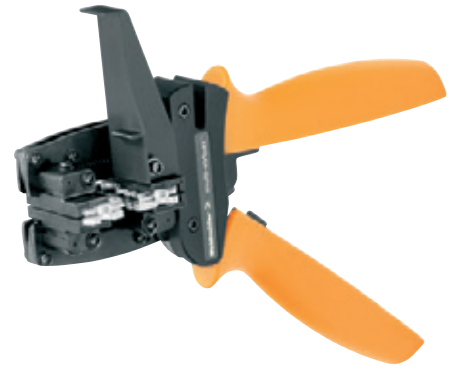

- Excellent stripping quality for industrial applications
- Specially shaped blades enable stripping of special types of insulation and conductor configurations
- Stripping length with end stop, adjustable from 2.3...30 mm
- Very versatile thanks to interchangeable stripping units
- Stripping results reproduced accurately over and over again
- No damage to the conductor
- A long-lasting, reliable tool thanks to its sturdy design
- Integrated cutting function up to 6 mm²

Technical data

Length / Width / Height	mm	241 / 338 / 79
Weight	g	1,800
Note		

Length / Width / Height	mm	241 / 338 / 79
Weight	g	1,800
Note		

Length / Width / Height	mm	250 / 85 / 40
Weight	g	250
Note		

Ordering data

Version	
Note	

Type	Qty.	Order No.
TOOL SET IE-POF	1	1208930000
Note		

Type	Qty.	Order No.
MULTI-STRIPAX IE-POF	1	1208800000
Note		

Accessories

Note	
-------------	--

Type	Qty.	Order No.
HTX-IE-POF	1	1208870000
MULTI-STRIPAX IE-POF	1	1208800000
KEVLAR SCISSORS	1	1208910000
Note		

Type	Qty.	Order No.
Replacement cutting blade	1	9203100000
Replacement stop set	1	9203070000
AIE MULTI-STRIPAX POF	1	1212770000
Note		

Crimping tools

- Ratchet for precise crimping
- Release option in the event of incorrect operation
- With end stop for exact positioning of the contacts

HTX-IE-POF



- Only one tool needed for all SC-RJ plug processing steps
- For processing 1 mm thick polymer optical fibres, especially for the PROFINET and EtherNet/IP-SC-RJ connectors
- For stripping Duplex polymer optical fibres
- The plug is crimped and the polymer optical fibres are separated, all in a single step
- Cut surfaces do not need to be polished after cutting
- Locator for precise positioning of the SC-RJ plugs
- Ergonomic handles
- High repeat accuracy

Three steps to produce IP 67 connectors:

- 1) Strip the Duplex polymer optical fibres
- 2) Crimp and separate
- 3) Crimp the strain relief

SCISSOR Kevlar



- Cable shears specially designed for aramid fibres
- Only for cutting aramid fibres (strain relief in fibre-optic cables)
- Do not use for other materials
- Special blade geometry
- Blades ground
- With teeth on the cutting edge
- Riveted joint
- Hand-friendly, impact-resistant plastic handles

Technical data

Material data
Length
Weight
Note

HTX-IE-POF
220
450

SCISSORS KEVLAR
147
100

Ordering data

Version
Note

Type	Qty.	Order No.
HTX-IE-POF	1	1208870000

Type	Qty.	Order No.
SCISSORS KEVLAR	1	1208910000

Fibre-optic cabling tools

Assembly case for fibre-optic connectors

Our fibre-optic assembly case is an indispensable set for helping you to assemble fibre-optic cables on-site.

IE-CTC-SCST-GOF



Contents:

- Crimping pliers for ST and SC plugs
- Kevlar shears
- Stripping tool for cable sheath and primary coating
- Stripping tool for secondary coating
- Fluorescent light with pluggable adapter
- Polishing and cleaning fluid
- Cleaning cloths
- Cleaning rod
- Polishing base support for pre-polishing and surface finishing
- Polishing foils
- Sapphire stylus
- Microscope, 100X magnification

Ordering data

--

Type	Qty.	Order No.
IE-CTC-SCST-GOF	1	1032030000

Note

--

--

Accessories

--

Accessory set for LC plugs

Type	Qty.	Order No.
IE-CTC-AS-LC-GOF	1	1033350000

Note

--

--

Crimping tools for other contacts

- Ratchet for precise crimping
- Release option in the event of incorrect operation

IE-CT-SC-GOF / IE-CT-LC-GOF

Crimping tools for IP 20 + 67 connectors



- For fibre-optic SC/ST, IP 20 and IP 67 connectors
- For fibre-optic LC and IP 67 connectors



Technical data

Tool data
Length
Weight
Note

IE-CT-SC-GOF	IE-CT-LC-GOF
250	250
730	730

Ordering data

Version
Note

Type	Qty.	Order No.
IE-CT-SC-GOF	1	9205320000
IE-CT-LC-GOF	1	9205330000

Accessories

Note

Type	Qty.	Order No.

Fibre-optic cabling tools

Crimping tool for other contacts

- Ratchet for precise crimping
- Release option in the event of incorrect operation
- With end stop for exact positioning of the contacts
- Contact and insulation are crimped in one step

HTF HYB

0.08...1.0 mm²



For Weidmüller hybrid sockets and pins

- ~AWG 28...AWG 17



Technical data

Description of contact	
Type of contact	
Crimping range	mm ²
Crimping range 1 (with multiple crimping positions)	mm ²
Crimping range 2 (with multiple crimping positions)	mm ²
Crimping range 3 (with multiple crimping positions)	mm ²
Tool data	
Length	mm
Weight	g
Note	

HTF HYB		
Hybrid sockets / plugs		
		0.08...1
		0.08...0.2
		0.2...0.5
		0.75...1

Ordering data

Version
Note

Type	Qty.	Order No.
HTF HYB	1	1119580000
Note		

N

Special stripping tools

- Quick and accurate stripping
- No need to adjust cutting depth
- No damage to inner conductors

LWL-stripax®



Stripping and cutting tool for plastic fibre-optic cables with 1-mm diameter inner conductor

- Stripping length adjustable via end stop
- Automatic opening of the clamping jaws after stripping

Technical data

Max. stripping performance	
Cable type	-
Conductor diameter	-
Stripping length, max.	-
Tool data	
Length	mm 135
Weight	g 110
Note	

M-D-STRIPAX LWL	
POF conductor with an inner conductor of 1 mm Ø	
...	1
Stripping length, max.	7.5
Length	135
Weight	110
Note	
POF: polymer optical fibre	

Ordering data

Version
Note

Type	Qty.	Order No.
M-D-STRIPAX LWL	1	9003750000
Note		

Accessories

Note

Type	Qty.	Order No.
Spare stripping blades	1	9003760000
Note		



General tools

Incision tool for twisted-pair cable

For connecting twisted-pair cable to terminal rails with IDC contacts e.g. in main and floor distributors, and in modular wall junction boxes for structured building cabling.

PDT



IE-FISP-V4



The punch-down tool has the following features:

- Mechanics made from metal components
- Adjustable pressing force for conductor sizes AWG 20 to AWG 28
- Different blades for connector blocks of type 110 from AT&T, type 66, type LSA Plus from Krone (Standard and scissors cutting function) as well as for telephone outlets 630A6
- Incision blades with 2 functions: incision or incision with cutting off of remaining conductor
- Storage compartment for one blade

Fastening tool for the hexagon cap nut from **STEADYTEC®** V4 flange and FrontCom® Micro.

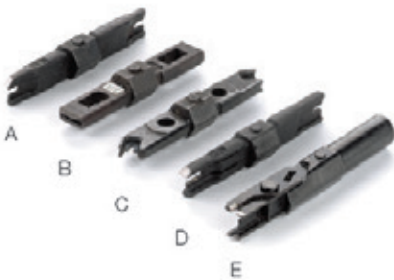

- A = PD blade 110
- B = PD blade 66
- C = PD blade 630
- D = PD blade Krone LSA (standard)
- E = PD blade Krone LSA (scissor)

Technical data

Length / Width / Height	mm
Weight	g
Note	

PUNCH DOWN TOOL PDT		
Length / Width / Height	160 / 37 / 29	
Weight	142	
Note		

Fixing tool		
Length / Width / Height	115 / 28 / 28	
Weight	21	
Note		

Ordering data

Version
Note

Type	Qty.	Order No.
PUNCH DOWN TOOL PDT	1	9013970000
(without blade)		

Type	Qty.	Order No.
IE-FISP-V4	2	9204370000

Accessories

Note

Type	Qty.	Order No.
PD blade Krone LSA Plus (scissor)	1	9014050000
PD blade 110	1	9013960000
PD blade 630	1	9013990000
PD blade 66	1	9013980000
PD blade Krone LSA Plus (standard)	1	9014000000

Type	Qty.	Order No.

Hydraulic sheet holes

Incl. accessories:

- 1 hydraulic screw Ø 19 mm
- 1 hydraulic screw Ø 19 x 9.5 mm
- 1 HSS pre-drill Ø 10 mm
- 1 spacer nut set (3-part)
- 1 bridge

IE-KO-HAT

- Overpressure valve protects against overloading
- Cylinder head angled 90°
- Angled head can be rotated through 360°
- Ergonomic handle springs back automatically
- The piece of waste no longer becomes jammed thanks to 3-fold cleaving
- Hydraulic punch manufactured from high-strength aluminium (approx. 40 % less weight)

Technical data

Maximum steel-sheet punching performance	
Round holes from 1 to Ø 85 mm	-
Round holes from 2 to Ø 64 mm	-
Square holes up to	-
Rectangular holes up to	-
Maximum stainless steel sheet punching performance	
Round holes from 3 to Ø 64 mm	-
Tool data	
Length x width x height	mm
Weight	kg
Punching force	kN
Max. operating pressure	bar
Note	

Ordering data

Version
Note

Accessories

Type	Qty.	Order No.
KOHS 19	1	9205010000
KOHS 9.5+19	1	9205000000
KOPD 10.0	1	9205020000
Note		

Type	Qty.	Order No.
IE-KO-HAT	1	1966810000
Note		

Custom stamp for Industrial Ethernet connections

Type	Description	Dimensions	Qty.	Order No.
IE-KOK-V1	Custom shape for Bajonet 01 metal	Diameter 27 mm x 1 side 25.9 mm	1	1966780000
IE-KOK-V4	Custom shape for Push Pull V04 plastic	Diameter 23.2 mm x 2 sides 20.2 mm	1	1966790000
IE-KOK-V5	Custom shape for RockStar® V05 metal	22.0 x 22.0 mm	1	9204790000
IE-KOK-V14	Custom shape for V14 flange	22.0 x 18.5 mm	1	1135240000

HDC KT – Cable grommets, small

Cable grommets, small, grey



HDC KT – Cable grommets, small

Cable grommets, small, black

Technical data

Material
Colour
Temperature range
Ingress protection class
UL 94 flammability rating
Note

free from elastomers, halogens and silicone
grey
-40 °C to +90 °C (static)
V0

elastomers with very high chemical resistance
black
-30 °C to +90 °C (static)
HB

Ordering data

Note

Type	Clamping range [mm]	Qty.	Order No.
HDC KT 5	5-6	10	1826480000
HDC KT 6	6-7	10	1826490000
HDC KT 7	7-8	10	1826500000
HDC KT 8	8-9	10	1826510000
Blanking plugs, small			
HDC BTK		10	1828170000

Type	Clamping range [mm]	Qty.	Order No.
HDC KT 5	5-6	10	1827810000
HDC KT 6	6-7	10	1827830000
HDC KT 7	7-8	10	1827840000
HDC KT 8	8-9	10	1827850000
Blanking plugs, small			
HDC BTK		10	1828200000

HDC KEL 16

Cable entry strip



KEL 16/8 with 8 small grommets



KEL 16/4 with closed half-shell for 4 small grommets



Snap frame KEL 16 SNAP

Technical data

Material	Polyamide, halogenfree, siliconfree
Colour	black
Temperature range	-40 °C to +140 °C (static)
Ingress protection class	IP 54, when correct cable grommet is used
UL 94 flammability rating	V0
Note	

Material	Polyamide, halogenfree, siliconfree
Colour	black
Temperature range	-40 °C to +140 °C (static)
Ingress protection class	IP 54, when correct cable grommet is used
UL 94 flammability rating	V0
Note	

Ordering data

Note	
-------------	--

Type	No. of grommet positions		Qty.	Order No.
	small	large		
HDC KEL 16/8	8	-	10	1825910000
HDC KEL 16/4	4	-*)	10	1825900000
Blanking plugs, small				
HDC KEL 16 SNAP			10	1827770000
*) with closed half-shell				

Dimensioned drawings

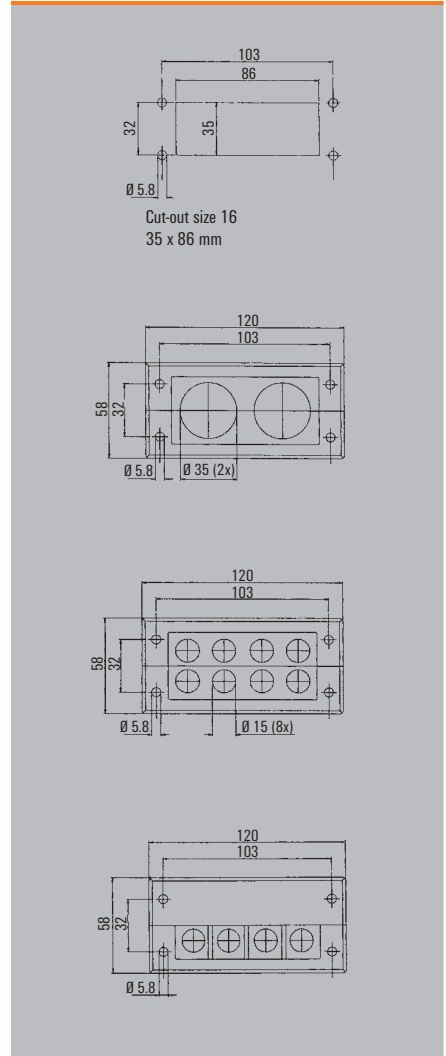

N

KVT 32

KVT 32 and locknut for D-Sub 9



KVT 32

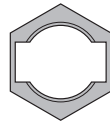

Locknut for D-Sub 9
KGM-SUB-D9

Technical data

Material
Colour
Temperature range
Ingress protection class
UL 94 flammability rating

Polycarbonate, free from halogens and silicone
grey, similar to RAL 7035
-30 °C to +100 °C (static)
IP 54, when the correct cable grommet is selected
V0

Note

Ordering data

Type	Thread	For grommet		Qty.	Order No.
		small	large		
HDC KVT 32	M 32 x 1.5	1	-	10	1826670000

Locknut for D-Sub 9

KGM-SUB-D9	M 32 x 1.5			10	1828250000
------------	------------	--	--	----	-------------------

Please refer to catalogue 5 for the complete range.

Note

Dimensioned drawings

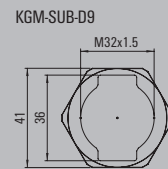
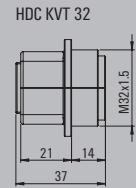

Dust-protection plugs for protecting empty ports

- RJ45
- **STEADYTEC**® variants
- M12

Dust Cap RJ45



- Dust Cap RJ45 with finger grip

Protective caps IP 67

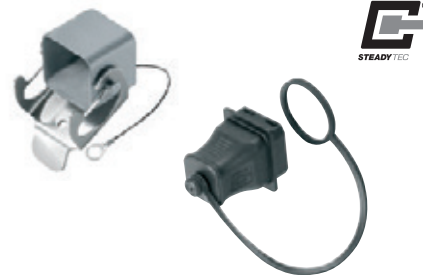

- Protective caps for all **STEADYTEC**® variants and for M12 plug-in connectors

Ordering data

Type	Qty.	Order No.
IE-DPC	100	8813490000

Note

Type	Qty.	Order No.
V1 Bayonet plug	10	1965690000
V1 Bayonet flange	10	1965700000
V4 PushPull plug	10	1963890000
V4 PushPull flange	10	1963900000
V5 HDC plug	10	1968920000
V5 HDC flange	10	1968930000
V14 PushPull plug	10	1058280000
V14 PushPull flange	10	1058310000
PushPull Power flange	10	1068930000
M12 plug	1	2330260000
M12 flange	1	8425960000

Note

Type	Qty.	Order No.
V1 Bayonet plug	10	1965690000
V1 Bayonet flange	10	1965700000
V4 PushPull plug	10	1963890000
V4 PushPull flange	10	1963900000
V5 HDC plug	10	1968920000
V5 HDC flange	10	1968930000
V14 PushPull plug	10	1058280000
V14 PushPull flange	10	1058310000
PushPull Power flange	10	1068930000
M12 plug	1	2330260000
M12 flange	1	8425960000

Note

The advanced inkjet printer

Our PrintJet ADVANCED for exacting standards

Flexible printing of plastic and metal markers

The PrintJet ADVANCED is an inkjet printer which prints plastic markers in MultiCard format and metal markers from the MetalliCard family. Thanks to its high magazine capacity, it is ideal for printing large volumes in continuous operation. The precise colour printing and thermal fixing guarantee optimum print results for durable equipment identification. With these properties, the PrintJet ADVANCED brings efficiency to the operating process – whether operated with our M-Print® PRO software or as a stand-alone solution with pre-installed print templates.



The advantages for you at a glance:

- Precise colour printing
- Printing of metal markers as standard
- High level of automation thanks to magazine capacity of 30 MultiCards
- Durable and robust markers thanks to thermal fixing
- User-friendly thanks to intuitive touch display
- Can be used as stand-alone solution

Technical data

	Description
Intended use	Printing Weidmüller MultiCards and MetalliCards
Technology	Inkjet procedure with integrated thermal fixing unit
Feed	Automatic magazine for max. 30 MultiCards Individual feed for MetalliCards and MultiCards
Fuses	Right fuse: 10 ATH 240/120 V Left fuse: 2.5 ATH 240/120 V
Application site	Office conditions
Ambient temperature	10 °C - 35 °C 0 °F - 95 °F
Dimensions	Length including output rail: approx. 1.138 mm (44.80") Length not including output rail: approx. 945 mm (37.20") Width: 554 mm (21.81") Height with touch panel folded down: 328 mm (12.91") Height with touch panel folded up: 422 mm (16.61")
Weight	57.8 kg (127.43 lb) with packaging 37.2 kg (82.01 lb) without packaging
Ink system	Colour system – black, cyan, magenta, yellow
Included in delivery	<ul style="list-style-type: none"> • PrintJet ADVANCED • Mains cable • USB cable • One MultiCard DEK 5/5 • One output rail • DVD with M-Print® PRO software • Quick start guide • Operating manual

The ink cartridges and ink collector tray are installed in the printer.

Inkjet printer

PrintJet Advanced

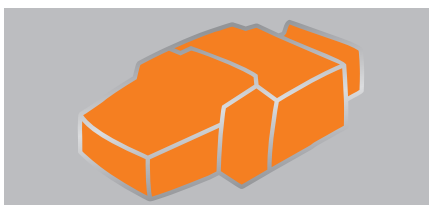

Technical data

EAN	4032248140121
Length	950 mm
Width	555 mm
Height	310 mm
Weight	58 kg
Net weight	37.2 kg
Printing method	Ink jet technology
Printer driver	Windows XP, Windows Vista, Windows 7, Windows 8
Printing speed	Depends on printing quality
Print quality	600 dpi / 1200 dpi
Marker type	MultiCard / MetalliCard
Interface	LAN, USB
Fueling system	Ink cartridge, CMYK
Supply voltage	230 V AC / 16 A, 115 V AC / 20 A
Operating system	Windows XP, Windows Vista, Windows 7, Windows 8
Software	M-Print® PRO

Note

Ordering data

Type	Qty.	Order No.
PRINTJET ADVANCED 230V	1	1324380000
PRINTJET ADVANCED 115V	1	1338700000

Note

Accessories

PrintJet Advanced		Type	Qty.	Order No.
	Software	M-PRINT PRO	1	1905490000
	Ink collecting tray	PJ ADV TNAW	1	1338710000
	Cyan ink	PJ ADV TNTK INK C	1	1338680000
	Magenta ink	PJ ADV TNTK INK M	1	1338670000
	Yellow ink	PJ ADV TNTK INK Y	1	1338650000
	Black ink	PJ ADV TNTK INK K	1	1338690000
	Ink set	PJ ADV TNTK INK SET	1	1338720000
PrintJet PRO		Type	Qty.	Order No.
	Ink collecting tray	PJ PRO TNAW	1	1024140000
	Cyan ink	PJ PRO TNTK INK C	1	1027050000
	Magenta ink	PJ PRO TNTK INK M	1	1027060000
	Yellow ink	PJ PRO TNTK INK Y	1	1027070000
	Black ink	PJ PRO TNTK INK K	1	1027040000
	Ink set	PJ PRO TINTENSET FARBE	1	1027110000

Note

N

Markers for cables and **STEADYTEC®**

Markers for cables and wires



SlimFix V0 for cables and wires

- Ø 4.7 to 6.8 mm SF5/21
- Ø 5.8 to 8.5 mm SF6/21

Ordering data

Type	Qty.	Order No.
VT SF 5/21 NE WS V0	160	1689470001
VT SF 6/21 NE WS V0	160	1730560001

Note: Can be printed with PrintJet PRO.

Accessories

Type	Qty.	Order No.

Markers for IE-Line **STEADYTEC®**



MultiCard ESG 9/11 K for IE-Line **STEADYTEC®**

- 9 x 11 mm
- White

Ordering data

Type	Qty.	Order No.
ESG 9/11 K MC NE WS	200	1857440000

Note: Can be printed with PrintJet PRO.

Accessories

Type	Qty.	Order No.

TM-I for pre-assembled M12 cables



MultiCard markers for labelling transparent M12 TM-I sleeves

- Tag length: 18 mm
- Tag width: 4 mm

Ordering data

Type	Qty.	Order No.
TM-I 18 MC NE WS	320	1718431044
TM-I 18 MC NE GE	320	1718431687

Accessories

Type	Qty.	Order No.
TM 4/12 HF/HB Length 12 mm	500	1719840000
TM 4/18 HF/HB Length 18 mm	500	1719850000

Note: Can be printed with PrintJet PRO.

V DATA Cat. 6 - surge protection for 8 wires with RJ45 socket

- RJ45 connection
- All 4 lines are protected
- Robust and compact metal housing
- Suitable for Cat. 5 (to 100 MHz) and Cat. 6 to 250 MHz (class E)
- Suitable for PoE (IEEE 802.3af) and PoE + (IEEE 802.3at)

V DATA CAT6

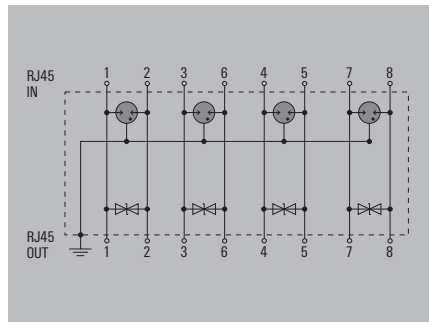

Technical data

Requirements category acc. to IEC 61643-21
Surge current-carrying capacity C2
Surge current-carrying capacity D1
Discharge current I_n (8/20 μ s) wire-wire/wire-PE/GND-PE
Discharge I_{max} (8/20 μ s) wire-wire/wire-PE/GND-PE
Lightning test I_{imp} (10/350 μ s) wire-wire/wire-PE/GND-PE
Type of connection
Storage temperature
Ambient temperature (operational)
Protection degree
Rated voltage (AC)
Rated current
Insertion loss @ 250 MHz
Protection level U_p typical

Approvals

Standards

Dimensions of complete module (arrester + base element)

Height x width x depth

Note

C2, D1
10 kA
1 kA 10/350 μ s
150 A / 1,25 kA
10 kA / 5 kA
1 kA / 1 kA
RJ45-Port
-40 ... +85 °C
-40 ... +80 °C
IP 20
48 V
1 A
≤ 1 dB @ 250 MHz
≤ 550 V

According to IEC61643-21

75 / 19 / 46 mm

Can also be used for Cat.5 applications

Ordering data

Note

Type	Qty.	Order No.
V DATA CAT6	1 ST	1348590000

Technical appendix

Added value for your application

Technical appendix	Online services	W.2
	Cable configurator	W.3
	Service and certificates	W.4
	Glossary	W.6

Online product catalogue

Your digital information source

If you have questions about the specifications and details of our products, even when outside normal working hours,

then our online catalogue at:

<http://catalog.weidmueller.com>

is open 24 hours a day, 365 days a year. As well as product features and part numbers, it contains extensive information on all our product groups.

For further information, simply visit our Weidmuller website at:

www.weidmueller.com

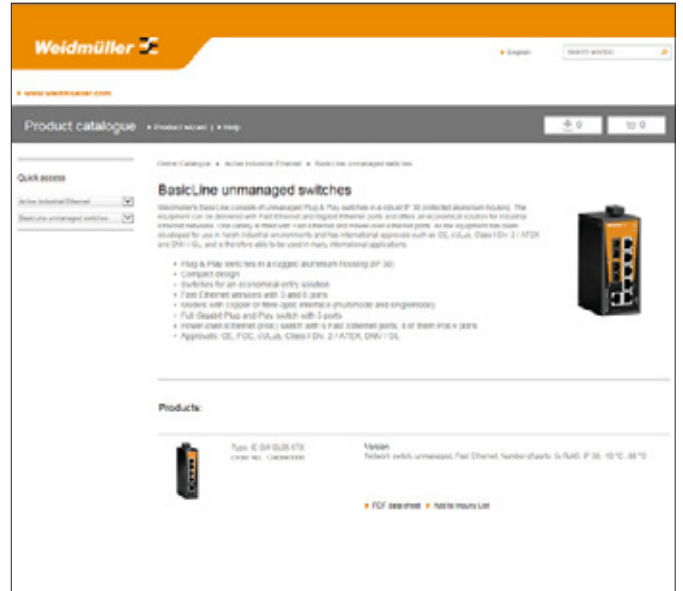

With one-click selection for the product data sheet of your choice.

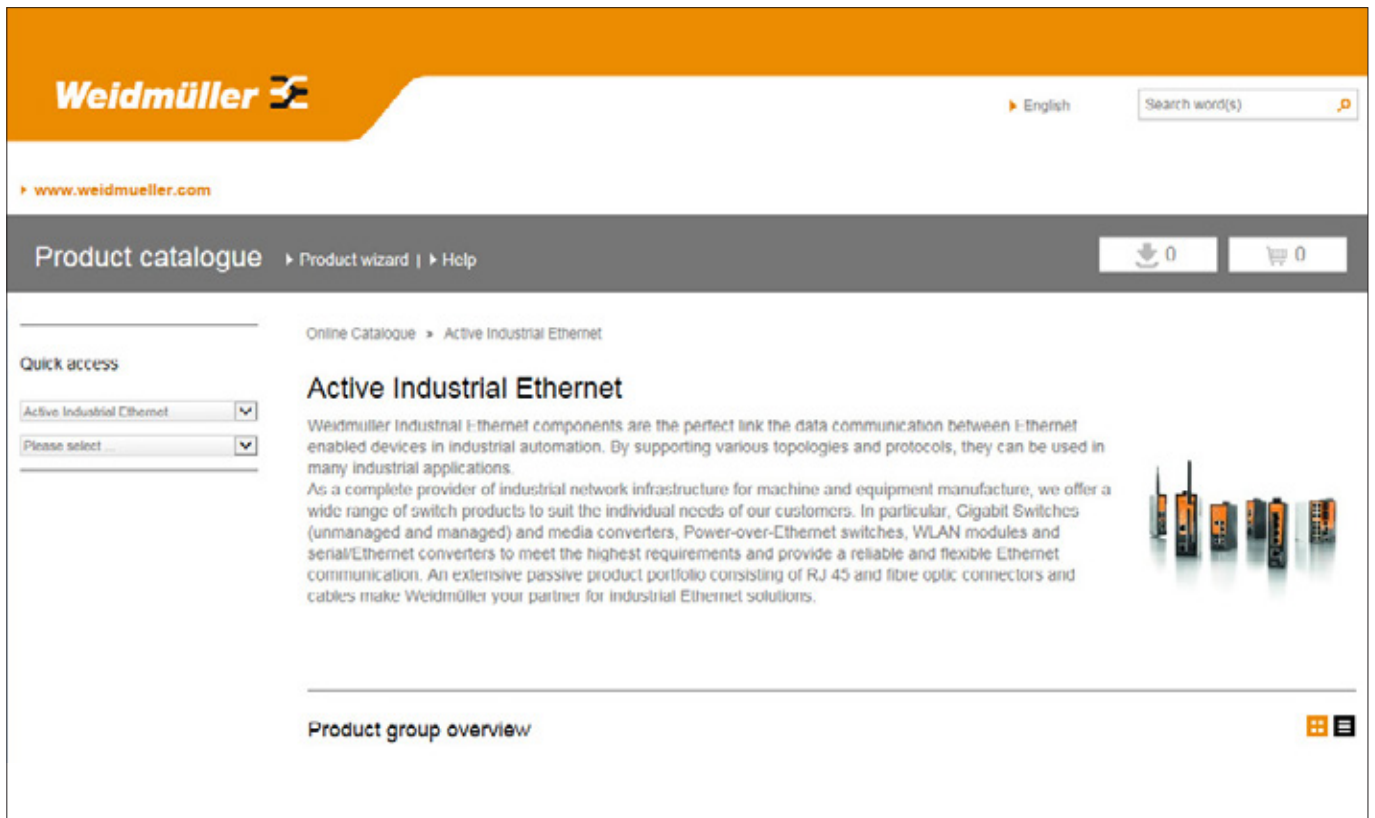

W

Cable configurator

Tailor-made connections

The cable configurator allows you to configure your specific cable with comfort, speed and simplicity. Just select, request order – and you are finished!

Make your selection from the list of available cables (material for cable sheathing, category, colour, ...). Next, choose the connector for both the right and left cable ends and then choose the cable length. Configurations which are not possible are marked in red, so that it is not possible to create an unsupported or wrong configuration.

A variety of cables and connectors are available from our Industrial Ethernet product line. These selections include category 5 or 7 cable, with PVC sheathing, in PUR, and of course PROFINET-specific cable. A number of versions are available on the plug side of the RJ45, including: IP 20, an extra-strong IP 67 PushPull (V4) versions, bayonet (V1) and RockStar® HDC (V5). The fibre-optic cable is configured similarly: simply choose the fibre-optic (MM/SM) and the desired connector in order to build your customised cable. IP 67 versions are also available.

After you have made your selection, there are several available options:

- Locate and display the data sheet for the assembled cable
- Export the information in Excel or CSV format
- Save the configuration
- Create additional cables or load previous cables
- Place the assembled cable in the shopping cart to obtain a quote or to order



The cable configurator is your quickest path to finding the specific industrial Ethernet cable which you need.

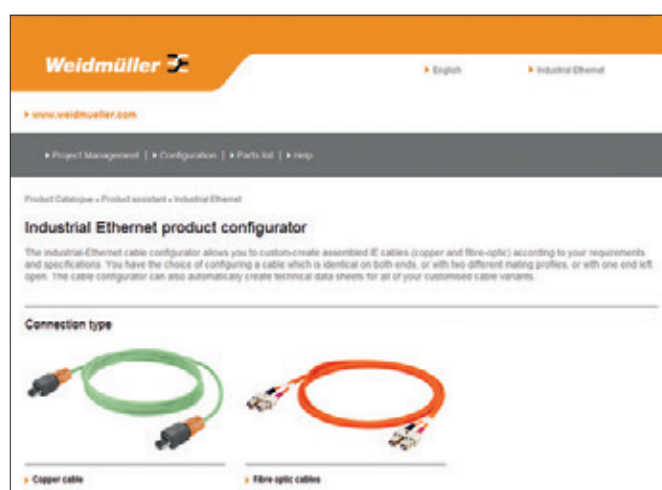

Whether you are looking for a fibre-optic or copper cable, the configurator will find it for you.

Practical service

In-depth planning support

Practical Guidelines for Industrial Ethernet

Are you an electrical engineer, installer or contractor working on Industrial Ethernet installations and in search of assistance, tips or checklists? Our practical guidelines provide detailed descriptions for the implementation of industrial networks.

- You'll find helpful tips and recommendations for selecting the proper components and for documenting your network
- Practical advice for assembling copper and fibre-optic cables
- Pointers to the current standards and regulations in the industrial networking sector
- Simple network implementation, including tips for operation and security
- Maintenance tips for preventing crashes
- ...and much more!

Please ask your personal sales representative about these practical guidelines.

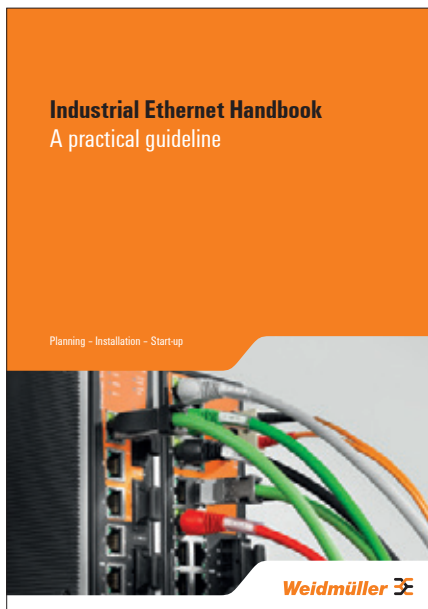

3-D data

Do you require 3-D models of your components so you can design them into your application? And accurately portrayed in your own CAD format?

Each component part is located in our Online Catalogue with a direct link to the Partserver (www.partserver.com). You simply input your product specification, CAD format and e-mail address and you will then receive a rapid e-mail response from us with your 3-D model attached.



You can also login at the web site <http://weidmueller.partcommunity.com/portal/portal/weidmueller> to view and download 3-D files.

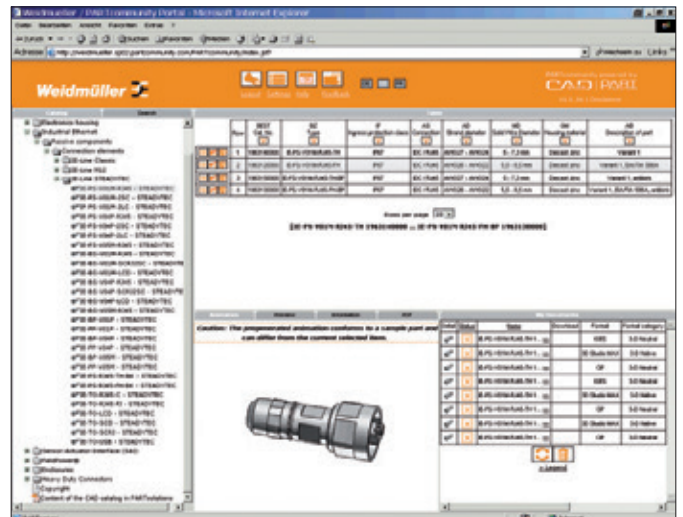

Quality through certification

Certified reliability of our solutions

Do you want to prove to your customer that you have installed only the highest quality components? The GHMT (Society for High-frequency Measuring Technology) and the 3P (Third Party Testing) are independent testing institutes and recognised specialists for industrial cabling. These institutes support the industry by means of test certifications for communication cables, connection hardware, patch cords and permanent links and channels.

Their other primary functions are brand testing, safety testing, quality analyses, and error analyses. These certificates are solid proof of the superior quality and performance expectations from our products. Please ask your personal sales partner if you would like to see a copy of our certifications. You can also download the individual certificates from our online catalogue.

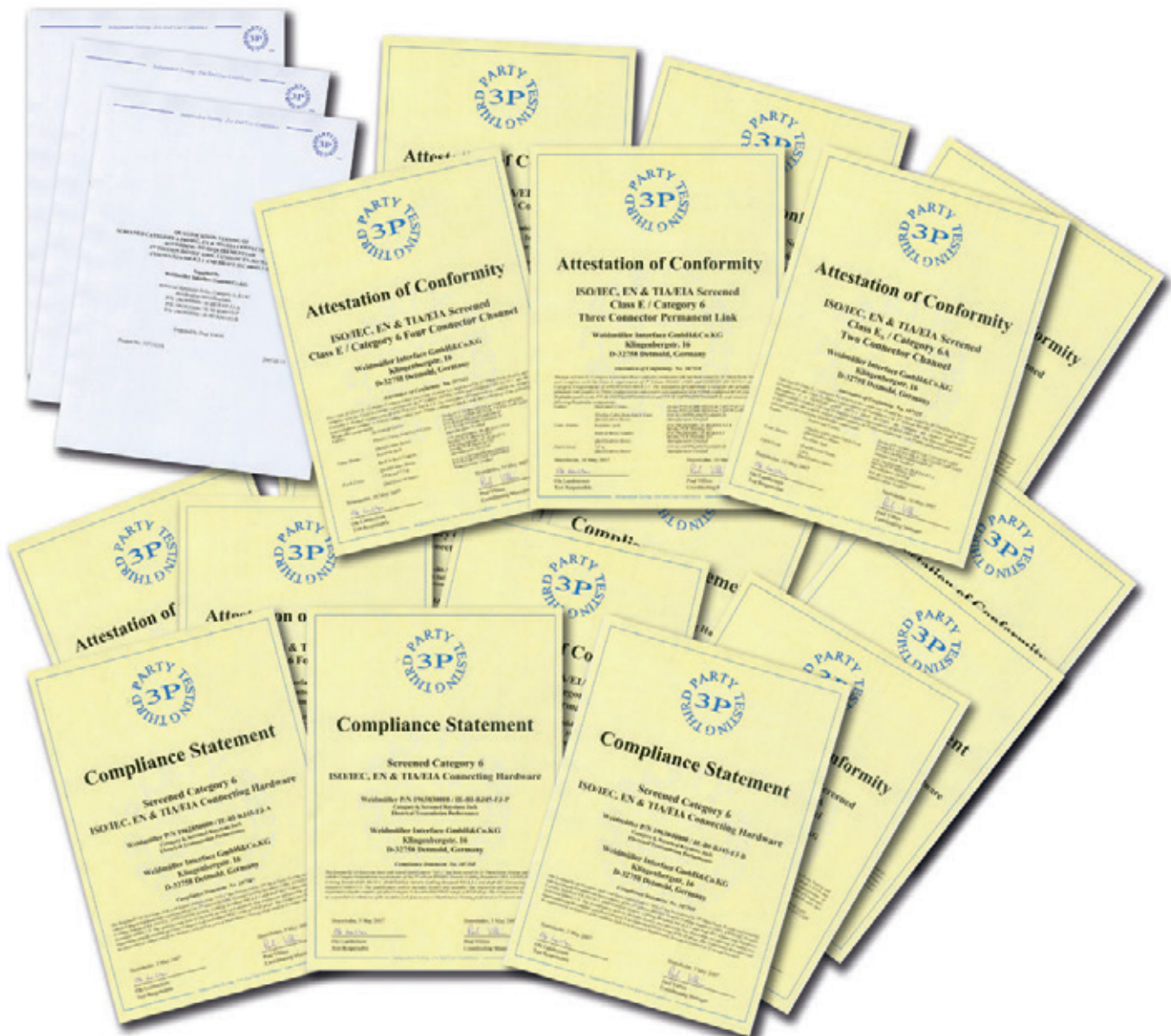

Glossary

Specialist vocabulary for Industrial Ethernet

Interest in Industrial Ethernet has produced an entirely new dictionary with specialist terms. Some of the most important terms are briefly explained here.

4B/5B

A block encoding system for FDDI and ATM. In 4B/5B encoding, all data is divided into 4-bit units (a nibble) and converted to 5-bit units (symbols) by reference to a matrix.

100BaseFX

100 Mbps Fast Ethernet, based on 4B/5B encoding with fibre optics.

100BaseSX

100 Mbps Fast Ethernet system, identical to operations in the 100BaseFx, but 850 nm fibre-optic technology is used.

100BaseTX

100 Mbps Fast Ethernet system based on 4B/5B encoding and transmission via two copper cables.

100BaseX

This term is used to describe Fast Ethernet technologies based on the 4B/5B encoding. Includes 100BaseTX and 100BaseFX systems.

802.3.IEEE

The CSMA/CD group is the oldest working group in the 802 project. It defines the norms according to the CSMA/CD access procedures proposed by the DIX-group. The focus of this working group is on high-speed protocols.

AUI

Stands for "Attachment Unit Interface". Interface between the transceiver and the network board.

Auto-negotiation

Auto-negotiation means automatic recognition of the opposite end's functions. By using RJ45 plugs for the different protocols, from 10Base-T to 100Base-T, a compatibility problem occurs which is solved due to automatic recognition of the opposite end. Using the auto-negotiation procedure, repeaters or terminal equipment can determine what functions the other end has, so that different devices can be configured automatically.

Bandwidth

Bandwidth states how much information can flow within a set period from one location to the other. Units: Bps, Kbps, Mbps, Gbps.

Baud

Baud is the unit of step speed. A step always lasts for a pre-set time e. g. 1 bit, 1_character. If you multiply the number of bits per state with the baud rate you obtain the transmission speed. Only if the number of states is exactly two (i.e. encoding was carried out at a state of exactly 1 bit), is the baud rate exactly the same as the bit rate.

Bit

Bit is an artificial word made up of binary and digit and constitutes the smallest unit of digital information, either a 0 or a 1.

Bitrate

Bitrate is also referred to as transmission speed, transmission rate or data rate. It is the number of bits that are transmitted per unit of time (typically one second). The bitrate is stated in Bps (bits per second) or in the appropriate powers of 10 as Kbps, Mbps and Gbps. In American English the abbreviation Bps is used.

Blowfish

In the digital information age, the handling of sensitive data is becoming ever more important. Therefore, we have incorporated Blowfish, a symmetrical encryption algorithm, into the software of our routers in order to guarantee a secure link between a pair of Weidmüller routers.

Bridge

According to their OSI definition, bridges connect sub-network protocols on layer 2 of the OSI reference model.

Broadcast

A broadcast transmission is a simultaneous transmission from one point to all network stations.

Bus

Buses are connection systems for electronic and electrical components. The topology of a bus is always a physical medium which the individual components are connected to and which is terminated at both ends. Transmission on a bus can be done bit or byte parallel, as in the PC-bus, or serially, as for networks in bus topology.

Cable material / properties• **LSZH**

LSZH is the abbreviation for Low Smoke Zero Halogen. This material is used in the wire and cable industry for cable sheathing. It consists of a thermoplastic or duroplastic compound. In the event of fire, the LSZH cable only releases very small quantities of toxic and corrosive gases and no halogens. It is mainly used in offices and the IP 20 part of the electrical cabinet. The cable is light and environmentally friendly.

• **FRNC**

FRNC is the abbreviation for Flame Retardant Non Corrosive. FRNC cables are specified, fire-retardant, special cables with low waste gas levels according to IEC standards 60332, 60754 and VDE0472/804. The FRNC cable contains no halogen and so only produces very little waste gas and a low fire load. One disadvantage of the cables is that they are not resistant to oil or chemicals and absorb a lot of water.

• **PUR (polyurethane)**

PUR is one of the so-called thermoplastic elastomers and possesses properties similar to rubber. PUR contains no halogen, is self-extinguishing and has very good resistance to UV light, chemicals and oil. It is suited to outdoor use and for heavily polluted, industrial environments. Compared with PVC, PUR offers major advantages in terms of its high tensile strength, wear resistance and increased resistance to chemical substances. Examples include mineral oils, alcohol-free benzene and many solvents.

• **PVC (polyvinyl chloride)**

PVC is an amorphous, thermoplastic synthetic material. It burns with a yellow, sooty flame and goes out quickly without further external sources of flame. Given its high chlorine content, unlike other technical synthetic materials such as polyethylene or polypropylene, PVC is flame-resistant. PVC is not halogen-free and releases toxic and corrosive gases in the event of fire. PVC is an easily processed material, is cheap and has good insulating properties.

Category 5

Signifies compliance to features specified in EIA/TIA-T568-5. With category 5 (Cat. 5) components, networks can be set up that are suitable for all twisted-pair cable Ethernet transmission systems up to 100 Mbps, including 10Base-T and 100Base-TX.

Category 5e

The Cat. 5e-cable is an extended version of Cat. 5 for use in 1000-Base-T networks or for long-distance 100-Base-T network connections (350 m, compared with 100 m for Cat. 5). It must fulfil the EIA/TIA-T568A-5 specification.

Category 6

A Cat. 6 twisted-pair cable is sufficient for Gigabit Ethernet, with a 250-MHz performance. This is an extension of the Cat. 5e cable.

Category 7

Cat. 7 cable is suitable for operating frequencies up to 600 MHz. It is made with four individually-shielded core pairs, all within another shielding.

Collision

Collision is when two or more stations transmit at the same time in a joint data channel – e.g. a semi-duplex Ethernet or a shared Ethernet. This means that the data transmitted is worthless because they overlay. By overlaying both signals, the signal level increases to what is known as the collision level. This aborts the transmission to both stations.

Collision domain

A collision domain is a segment of a CSMA/CD network. In 802.3 Ethernet networks all terminal equipment is on a physical Ethernet segment, including equipment that is interconnected via a repeater, on the same collision domain. In contrast to repeaters that do not affect the collision domain, bridges and routers separate the collision domains.

CRC

CRC is an error correction method that creates checksums based on binary numbers by calculating the sums of data groups prior to transmission. CRC is based on the division of polynomials. The principal is that during cyclical block checking, the bits to be monitored are successively fed into a feedback shift register. The length number and position of the feedback from the register are stated according to each procedure. The checksum procedure detects individual errors reliably and multiple errors with a high degree of probability.

Crossover-cable

A crossover-cable is a special patch cable where the transmitter and receiver lines at one end have been swapped. Crossover-cables are used to connect two pieces of terminal equipment (computers) or two infrastructure components (switches). Modern switches, because of their auto-crossing function, make connecting normal patch cables with one another possible.

CSMA/CD

An access procedure where several network stations have access to the transmission medium. In the CSMA-system the transmitting station listens to the channel (carrier sensing) before it transmits. A station can then only transmit if the transmission medium has not yet been occupied by another station. If the transmission medium is occupied, the station waits till it is free and can transmit. Because of the signalling times it is still possible for two devices to transmit at the same time. To avoid data loss in this type of collision, both transmitters have to detect the collision (collision detect) and after a randomly-selected waiting time send each of their data packets again. CSMA/CD is a widespread standard process in 10-MBit-networks with hubs.

In Industrial Ethernet networks the CSMA/CD system is only used rarely nowadays, because of high demands on network performance.

DCE

(Data Communication Equipment)

Any facility that can relay data between data terminal equipment. DCEs are part of the infrastructure and not terminal equipment.

DHCP

DHCP (Dynamic Host Configuration Protocol) enables a specially configured server to allocate dynamic IP addresses and other network parameters to the computers in a network.

DNS-Server

On the Internet, computers are addressed using their numeric IP address (e.g., 211.163.5.38). The DNS server maintains the structure of the domain name system (DNS). It administers and updates the logical names which are associated with the IP addresses. The name server converts less-accessible dotted-decimal-notation numbers into domain addresses. It then makes this information available to DNS clients on request. A network may include an unlimited number of name servers. Since DNS servers must have built-in redundancy, a server implementation consists of two servers: the primary (PNS) and secondary (SNS) name server. If the primary name server is down, the secondary name server, running in parallel, takes over.

DTE

(Data Terminal Equipment) data terminal unit: Every device in the network where a communications route starts or finishes. A station (computer or host) in the network that can transmit or receive data.

DynDNS

DynDNS stands for dynamic domain name system. DNS is responsible for resolving host names to IP addresses. Services such as DynDNS were developed for users using a DSL connection with dynamic IP addresses. DynDNS enables the registration of a dynamic (changeable) IP address to a host name. For this to work, a DSL router must support it or a DynDNS client must be installed on a PC.

Error Detection

The error detection code is a detection code (CRC or checksum) used where errors are identified but not corrected as in ECC.

Ethernet

Ethernet is computer networking technology for local networks (LANs). It refers to cable types and signalling for the bit transfer layer (physical layer), packet formats and protocols for checking media access (media access control, MAC) / link layer of the OSI model. Ethernet is standardised to a large extent in the IEEE norm 802.3.

Fast-Ethernet

Nowadays a very widespread version of Ethernet with 100 Mbps over a twisted pair cable according to category 5 or higher. The maximum range is 100 m.

Fibre-optic cables

A type of cable with fibre-optics or plastic core that transmits digital signals in the form of light pulses. (Wave lengths 850 nm in 10BaseFL and 100BaseSX or 1300 nm in 100BaseFX).

Flow Control

This is a function to modify transmission to the capacity of the receiver. Flow control regulates transmission between the transmitter and receiver by causing the transmitter only to send as much data as the receiver can deal with. The different types of Ethernet have different flow control systems. In credit systems (FO cable) the receiver relays to the transmitter the number of data packets that can be transmitted without confirmation. Duplex connections use the PAUSE signal for flow control and back pressure is used in semi-duplex systems to control the data rate.

FO (Fibre-optic cables)

Fibre-optic cables provide an alternative transmission medium to copper. A distinction is made between pure glass fibres (GOF: multimode/singlemode), combined fibres (PCF/HCS) and plastic fibres (POF). They are primarily used because of their insensitivity to electromagnetic interference, but also, in the case GOF, on account of the significantly longer cable lengths compared to copper.

The fibres are usually defined according to the core/sheathing diameter in microns (μm):

GOF/MM: 50/125 or 62.5/125

GOF/SM: 9/125

PCF: 200/230

POF: 980/1000

Conventional fibre-optic connector standards include SC Duplex, SC-RJ, LC Duplex and ST (also BFOC).

Forwarding

The process whereby frames are relayed from one port to another in the switch.

Frame

A frame is a data transmission frame on the link layer (layer 2 in the OSI model), which includes the header and trailer information that the bits transmission layer requires for transmission. All frame formats together form the start delimiter of a frame, the destination and source address (destination and source address), the data itself and an errorchecking device (a frame check sequence). A maximum of 1500 bytes, with VPN-information of 1524 bytes of payload data per packet are possible in the Ethernet.

Full Duplex Operation

In full duplex operation or duplex operation both communications partners can communicate bi-directionally at the same time.

Gigabit Ethernet

A version of Ethernet operating at a data transmission rate of 1000 Mbps.

Hub

A hub is a data communications facility (DCE) that makes it possible to connect three or more devices in a star topology. Modern Ethernet installations hardly use hubs any more but use switches for this purpose because of the higher network output that occurs as a result and the predictable transmission times.

IEEE

Association of American Engineers dealing with norm issues.

IGMP snooping

A switch equipped with IGMP (Internet Group Multicast Protocol) snooping can check whether join requests for a multicast group occur behind the ports. If this is the case, the port concerned is accepted in the forward table for this group. This reduces the load on the network because the switch does not flood all ports with multicast traffic.

Jabber

The jabber messaging protocol is a method in Ethernet networks that prevents a station from occupying the transmission medium for longer than permitted. The jabber function is an element of the IEEE 802.3 standard and provides an interrupt mechanism with which a MAU (Medium Attachment Unit) is interrupted during the transmission process when this transmits data on the cable for longer than 30 ms, or the standard defined packet length of 1518 bytes is exceeded. SQE (Signal Quality Error) signals are sent to the terminal equipment at the same time as the interruption and these cause the terminal equipment to terminate the data transfer. An error function in which a network component continuously sends meaningless signals to the network is also known as a jabber.

LAN

(Local Area Network) local network e.g. within a building.

Link Integrity Test

This test ensures that the Ethernet link is connected properly and that the signals are transmitted correctly. This can be helpful but does not guarantee that the link is fully functional.

Link Layer

The link layer in the OSI reference model.

Link Pulse

The NLP pulse is a recognition pulse that is transmitted from 10Base-T-stations to 100Base-T stations for auto-negotiation. The NLP is a periodic pulse with an interval of 16 +/- 8ms.

LLDP – Link Layer Discovery Protocol

LLDP is a layer-2 protocol in compliance with the IEEE-802.1AB standard. It defines the possibilities for exchanging information with neighbouring devices. Information is periodically sent from supported devices to all devices on the network. Neighbouring devices which support LLDP are then able to receive this data independently.

M12 D-coded

M12, D-coded is a 4-pole plug-in connector variation for Industrial Ethernet according to ISO IEC 61076-2-101. It carries out data transmissions according to Cat. 5 and guarantees IP 67 protection.

MAC Address

The MAC address is the six byte long hardware address that uniquely identifies a node in the network. The MAC address is hard-coded onto a chip and cannot be manipulated. MAC addresses are assigned according to a particular key that includes unique adapter recognition, identification of the manufacturer and an ID for operating and managing.

Manchester Encoding

Signal encoding where the binary information is shown by the sign of a change in voltage within the bit time. This means that transmitters and receivers are very easy to synchronise, as the transfer in the middle of the bit time produces a reliable frequency. The first half of the bit time includes representing the complementary bit value to be transmitted, the second half represents the bit value (specified for IEEE 802.3 Ethernet and used in 10 Mbit networks).

MDI

The Physical Medium Attachment (PMA) and the Medium Dependent Interface (MDI) both form the actual transceiver (MAU) for the 802.3 standard. The MDI is the physical (electrical, optical) and mechanical interface up to the medium. In the different 802.3-types the interface has a different structure.

MDI-X

MDI stands for Medium Dependent Interface and refers to an Ethernet connection. Auto MDI/MDIX (autocrossing) makes the automatic modification of the transmitting and receiving line of a port possible, i.e. the connected Ethernet cable (crossed/uncrossed) and the configuration of the opposite station (MDI/MDIX) are recognised automatically and its own port is configured appropriately. So all auto MDI/MDIX ports can be used as uplink port.

Media converters

Media converters connect different types of cable and maintain the structure and the functions of the network. In its simplest form a media converter is a quadrupole in the form of a box or network adapter card with a power supply. It modifies different cables – coaxial cables, TP-cables and FO cables – and different plugs to fit one another. In this way media converters can for example be used to modify 100Base-TX to 100Base-FX or to convert monomode fibres to multimode fibres. By using media converters the boundaries of network extension can be increased by using fibre-optic routes. In addition, existing networks can be inexpensively integrated into new network concepts. The Weidmüller range includes media converters on copper-based 10Base-T or 100Base-TX on fibre-optic transmission and vice versa.

Multicast

Multicast is a type of transmission from a single point to several subscribers at the same time (group).

Multimode

Refer to FO

NIC

A network adapter board is a circuit board or another hardware component that connects the network directly with the terminal equipment. It can be a plug-in board for the bus system in the terminal equipment. The network adapter board is the physical interface to the communications network. It includes the appropriate jacks for connection to the physical medium.

OLE

Object Linking and Embedding (OLE) is an interface developed by Microsoft to link and embed data across different applications. In this way external, but OLE-compatible, texts, graphics or tables can be embedded in other OLE applications. Linking OLE-compatible data is carried out via a link to the appropriate file. The original file remains untouched. During embedding, a copy of the file is inserted into the document.

OSI

OSI are internationally-agreed standards which open systems should work with and define the rules for implementing these norms. Communications systems are a combination of network hardware and network and systems software in a group of networked devices that permit free exchange of information between these devices on the basis of joint protocol agreements and interfaces, independently of the type of these devices or how they are equipped. Systems that implement OSI protocols are an example of this. The OSI standards are freely available and not protected by licences.

Packet

A data packet is a defined arrangement of characters as part of the data network, that are treated as a unit in transmission services with data packet transmission. As well as the payload data, data packets also include control information for addressing, sequence of transmission, flow control and error adjustment at all protocol levels. A data packet can be of a predetermined or variable length, but a maximum length is specified. If the whole destination address is included in each data packet, it is called a datagramme. On the other hand in a virtual connection only the first data packet has the whole address, whereas in the following data packets an assignment is made to the appropriate connection.

Patch cable

In the floor distribution point the patch cable creates a flexible connection between floor distribution point and the horizontal wiring. Patch cables are FO cables or copper cables and are also called jumper cords. Patch cables should be very flexible, have a tight bending radius and if possible should max the fixed cable. Patch cables are taken into account in the ISO/IEC 11801 and EN 50173 standards, but are not included in the transmission features specified for the link classes. This should be changed when ie. the channel standards are revised. The patch cable should then, at a length of up to 5 m, be part of a new definition, the channel specification and included in all the transmission features. The jumper cord and a connection cable, also 5 m long, will then be taken into account in this specification.

PAUSE

A single frame is sent via the full-duplex mode to the available stations, to signify that transmissions are to be reduced.

PCF

Refer to FO

PHY

Physical Layer device. This term is mostly used for a transceiver in Fast and Gigabit Ethernet.

Physical Layer

The Physical Layer (PHY) is the top sublayer or physical layer consisting of the PMD-sublayer and the PHY-sublayer. The PHY-sublayer is underneath the MAC layer and encodes, decodes and synchronises the station with the transmission frequency and the regeneration of the transmission frequency.

PoE (Power over Ethernet)

Power over Ethernet (PoE) is a procedure which allows power to be supplied to a network compatible device over the 8-wire Ethernet cable. The first version of the procedure is defined under IEEE802.3af and includes performance classes up to max. 15.4 W. There has since been a further development called PoE+. The respective standard is IEEE802.3at and it primarily involves an increase in max. power to 30 W.

Overview of PoE/PoE Plus

	PoE	PoE Plus
Minimum cable type	Cat. 5e	Cat. 5e
IEEE standard definition	802.3af	802.3at
Maximum power per PSE port	15.4 W	30 W
Maximum power to PD	12.95 W	25.5 W
Twisted pair used	2-pair	2-pair

POF

Refer to FO

Point-to-Point Technology

A type of connection where a connection is generated between two pieces of terminal equipment. Point-to-Point connections occur in the networked environment, in radio broadcasting, in beam radio and in the service area. In networks, where point-to-point connections are concerned, instead of a user network interface, an interface to a central facility in the network can also be operated. The connection can be permanent or on demand.

Port

Connector on a hardware unit. Usually an input/output channel on the computer or other hardware unit such as modem, router, hub or multiplexer.

Port Mirroring

Port mirroring means that the data traffic of a switch port can be mirrored, in order to detect errors or to measure throughput, onto another port to which a management station can be connected.

PPPoE

The PPoE (Point to Point Protocol over Ethernet) was developed in order to connect components and LANs to the Internet. It takes advantage of the divided Ethernet environment together with the trusted and secure dial-up access user model from PPP. It allows individual PCs to establish PPP sessions to various target networks simultaneously. A LAN and multiple components can also establish multiple simultaneous PPP sessions for connection to various target networks.

Promiscuous Mode

The Promiscuous Mode is a particular receiver mode for network equipment. In this mode the device reads all the incoming data traffic sent to the network interface that has been switched to this mode and transmits the data to be processed to the operating system. Normally this device would only process packets directed to itself, which is done for example in Ethernet networks by evaluating the MAC address.

Propagation Delay

The delay is the time that the signal requires to go from one point in a transmission channel to another. Depending on the transmission medium, the delay is the speed of light, as in satellite transmission, or less when transmitting in data cables and FO cables. It does not depend on the speed of light, but depends mostly on the dielectric constant of the medium or in FO cables on the refraction.

Protocol

A data transmission protocol establishes the rules for the exchange of information in the form of a directory. This includes all formats, parameters and specifications for a complete, perfect and effective transmission of data. Protocols include conventions on data formats, times and how errors are treated when exchanging data between computers. A protocol is a convention on setting up connections, monitoring connections and terminating connections. Different protocols are necessary in a data connection. Protocols can be assigned to each layer of the reference model. There are communication protocols for the bottom four layers of the reference model and higher protocols for control and data provisioning and its application.

Quality of Service (QoS)

QoS are all procedures that influence the flow of data in LANs and WANs so that the service which arrives at the receiver is of a particular quality. The ITU has developed a hierarchical QoS model, which takes both the technical aspects of the service into account and the availability and handling of the terminal equipment. The ITU defined three QoS classes on this basis.

Rapid Spanning Tree

The IEEE Standard Rapid Spanning Tree protocol (RSTP, IEEE 802.3w) is – apart from RapidRing™ – another option to provide redundancy in a network. The RSTP makes a structure similar to the network possible. In this way multi-redundancy can be achieved. Using RSTP in a network is not as simple as using RapidRing™, but RSTP does have a lot of interesting options.

Remote Management

Remote Management of a switch from every network station equipped with Telnet or web browsers. Remote Management assumes that each switch has its own IP address.

RJ45

The advantages of the RJ45 slot system are its compactness and simplicity. It is used for horizontal wiring and wiring work places. The RJ45 slot system is an eight pole miniature slot system for use in connections with SDP and UTP cables. The plug's eight contacts have serial numbers and are protected from corrosion and mechanical stress with a thin gold layer. The contact points are situated between guide rails and the cable is connected with insulation piercing. On the side opposite to the contact side, the RJ45 plug has a fluke that locks the slot when sticking it into a RJ45 jack.

SC-plug-in connection

The SC-plug is a small polarised push/pull plug with high packing density. This LWL-plug is square and can be used for multimode fibres and monomode fibres. Typical insertion loss is at 0.2 dB to 0.4 dB, operating loss in monomode fibres at 50 dB and multimode fibres at least 40 dB. If monomode fibres with a skew angle coupler are used instead of an oval coupler, the operating loss increases to at least 70 dB. In the duplex type, as a SC-Duplex plug, the plug must be used where there is fibre-optic wiring to the terminal equipment. It is also increasingly used in new installations and in FCS and ATM applications.

Segment

The term segment has many meanings. In networks a segment is a network section delimited by bridges, routers or switches. Where LANs are concerned, a LAN segment or a collision domain is referred to. In token ring networks, it means the transmission section between two neighbouring data stations. In the TCP specifications, a segment describes a single information unit on the communication network.

Semi-duplex operation

The semi-duplex procedure allows bidirectional use of a single transmission line. The interfaces, however, can only either transmit or receive at any given time.

Singlemode

Refer to FO

Slot time

This is an important Ethernet value. The slot time is twice the speed of the signal propagation time between the two networks that are farthest away from one another and the minimum packet length of 64 bytes or 512 bits. At a frequency clock speed of 10 Mbps, or a frequency clock cycle of a 100 ns, this produces a slot time of 51.2 μ s. At 100 Mbps the frequency is 10 ns, so therefore the slot time for the same packet length is 51.2 μ s. The greater the slot time, the poorer the Ethernet performance.

SNMP

The SNMP protocol means that central network management for many network components is possible. SNMP's main objectives are to decrease the complexity of the management functions, to extend the protocol and to be independent of any network components. The SNMP protocol supports monitoring, controlling and administration of networks. According to the SNMP architecture model a network is divided into network management stations (NMS) and network components. The network management stations carry out applications to monitor and control the network components. The network components have management agents, which carry out management functions.

Spanning Tree Protocol

-> see Rapid Spanning Tree.

ST connector

This LWL-plug (IEC-SC 86B) specified by AT&T is suitable for both monomode fibres and multimode fibres. The ST-plug is a commonly-available plug, used in LANs. It uses a bayonet lock as its locking system. In this LWL-plug the FO cable is guided through a ceramic or metal ferrule with a pin diameter of 2.5 mm and is prevented from twisting by a metal pin. The ceramic ferrule has been grounded to make its contact area convex. A spring means that there is constant contact to the front of the fibres to be connected.

Star topology

In star topology the transmission stations are connected in a star shape to a central node. Star topologies can only exchange data indirectly via the central node. There is a difference between active and passive star systems. In the former, the middle node is a computer that takes over relaying the messages. Its capacity determines the performance of the network. For example: private exchanges. Passive systems only have one node in the middle that combines the routes. This node does not have any exchange role, its purpose is signal regeneration. Passive star systems can for example be operated with TDMA, CSMA/CD or token access procedures.

Straight-through

A type of cable where the cable connections at both ends are the same. This type of cable is mostly used to connect devices such as switches with the station. Straight-through is the normal way of wiring cables – in contrast to crossover cables.

Station

Each hardware component in a network and the terminal equipment connected to the network. Server, router, telephone, fax machine etc and all communication devices connected with a network adapter (NIC).

Switching Hub

Switches are network components that have switching functions. These switching functions can also take place as exchange functions in long-distance networks and in local networks. In long-distance networks the local exchanges have local switches and the remote exchanges have central switches.

Topology

The configuration of the network nodes and connections is called the physical topology. The logical connections of network nodes possible are referred to as the logical topology. This states which node pairs can communicate with one another and whether they have a direct physical connection. The physical and logical topology does not have to be identical in networks. As a rule network topologies can be divided into two classes, where in the first class connections from one node to the next one are set up and in the second class all network nodes are directly connected to the transmission medium. The most well-known network topologies are ring topology, bus topology, tree topology and star topology. There is also meshed topology in long-distance networks

Transceiver

Transceiver is a compound word made up of transmitter and receiver and signifying a transmitting/receiving device. The transceiver implements network access of a station to the Ethernet and is sometimes called a MAU.

Trunking

The term trunking occurs in Ethernet networks but also in private exchanges and in mobile communication. In large Ethernet networks trunking is the parallel switching of several Ethernet links. The transmission via the parallel links is used to scale the bandwidth and is activated by the spanning tree algorithm. As the spanning tree protocol is unsuitable for granular bandwidth scaling, this technology has been standardised in the IEE 802.3ad working group and called "Aggregation of multiple link segments".

Twisted-Pair Cable

A twisted-pair cable is a symmetrical copper cable consisting of two wires that are twisted together. The conductors consist of insulated copper conductors. In contrast to asymmetrical cables, such as coaxial cables, symmetrical cables do not have reference potential. The advantage is that wires can be arranged to prevent interference between the lines.

VLAN

Virtual networks or virtual LANs (VLAN) are a technological concept for implementing logical work groups within a network. This type of network is implemented using LAN-switching or virtual routing on the link layer or on the network layer.

Web server

A web server is a server programme that provides files via HTTP protocol. These files are usually websites, pictures and style sheets. It makes no difference to the web server what type of files it supplies. Each time a website is requested (for example by clicking a link), the browser sends an HTTP query to a web server. This web server can then send the site requested back. The standard ports for the web server are 80 for HTTP protocol and 443 for HTTPS, the encrypted HTTP (for example with SSL). Usually all page requests are saved in a log file, from where – by using log file analysis – different statistics on access can be generated. However these do not give the full picture, as HTTP is a connectionless protocol.

Index

Index	Index Type	X.2
	Index Order No.	X.6

Type	Order No.	Page
A		
AIE MULTI-STRIPAX POF	1212770000	N.10
AM 12	9030060000	N.4
C		
CABTITE KEL 16/4	1825900000	N.19
CABTITE KEL 16/8	1825910000	N.19
CABTITE KEL SNAP 16	1827770000	N.19
CABTITE KT 5	1826480000	N.18
CABTITE KT 5 b	1827810000	N.18
CABTITE KT 6	1826490000	N.18
CABTITE KT 6 b	1827830000	N.18
CABTITE KT 7	1826500000	N.18
CABTITE KT 7 b	1827840000	N.18
CABTITE KT 8	1826510000	N.18
CABTITE KT 8 b	1827850000	N.18
CABTITE KT BTK	1828170000	N.18
CABTITE KT BTK b	1828200000	N.18
CABTITE KVT 32	1826670000	N.20
CABTITE SUBD9	1828250000	N.20
CASSETTE CST BLAU	9032020000	N.4

Type	Order No.	Page
E		
EBR-MODULE RS232	1241430000	F.9
ERAN MULTI-STRIPAX	9203100000	N.10
ERME 110 PDT	9013960000	N.16
ERME 630 PDT	9013990000	N.16
ERME 66 PDT	9013980000	N.16
ERME LSA PLUS SCHERE	9014050000	N.16
ERME LSA PLUS STANDARD	9014000000	N.16
ERME MULTI-STRIPAX	9203070000	N.10
ESG 7/20 SIRIUS MC NE WS	1736181044	I.2
ESG 7/20 SIRIUS MC NE WS	1736181044	I.3
ESG 7/20 SIRIUS MC NE WS	1736181044	I.4
ESG 7/20 SIRIUS MC NE WS	1736181044	I.5
ESG 7/20 SIRIUS MC NE WS	1736181044	I.6
ESG 7/20 SIRIUS MC NE WS	1736181044	I.7
ESG 9/11 K MC NE WS	1857440000	N.24

Type	Order No.	Page
F		
FZE ESD 130	9204760000	N.9

Type	Order No.	Page
H		
HTF HYB	1119580000	N.14
HTX-IE-POF	1208870000	N.11

Type	Order No.	Page
I		
IE-5CC4x2xAWG26/7-PUR	8813200000	L.8
IE-5CC4x2xAWG26/7-PVC	8813190000	L.8
IE-5IC4x2xAWG24/1-PUR	8813160000	L.6
IE-5IC4x2xAWG24/1-PVC	8813150000	L.6
IE-5TC4x2xAWG26/7-PUR	8813210000	L.13
IE-7CC4x2xAWG26/7-PUR	8813180000	L.9
IE-7CC4x2xAWG26/7-PVC	8813170000	L.9
IE-7IC4x2xAWG23/1-PUR	8813140000	L.7
IE-7IC4x2xAWG23/1-PVC	8813130000	L.7
IE-AD-BHS-V14M-RJA	1302000000	J.8
IE-AD-M12DRJ45-MF-180	1514970000	J.38
IE-AD-M12DRJ45-MF-90	1514940000	J.38
IE-AD-M12XRJ45-180	1400620000	J.43
IE-AD-M12XRJ45-90	1400610000	J.43
IE-ANT-3G-806-2170-2-NF	1491160000	F.6
IE-ANT-O-ABG-360-7-NF	1367130000	F.2
IE-ANT-O-AH-360-5-NF	1367120000	F.3
IE-ANT-O-AH-360-5-NF	1367120000	F.6
IE-ANT-O-BG-360-6-NF	1367090000	F.3
IE-ANT-P-ABG-75-9-NF	1367140000	F.2
IE-BHC-V14M-RJA	1047950000	J.5
IE-BHD-V01M-SCA	1221030000	J.15
IE-BHD-V04P	2027660000	J.25
IE-BHD-V14M	1047940000	J.5
IE-BHD-VAPM	1068920000	J.59
IE-BHS-V14M-RJA	1011540000	J.5
IE-BHS-V14M-RJA-45	1296710000	J.8
IE-BH-V01M	1963540000	J.13
IE-BH-V01P	1963540000	J.17
IE-BH-V01P	1016960000	J.19
IE-BH-V04P	1963520000	J.25
IE-BH-V05M	1963530000	J.31
IE-BI-BNC-C	1345020000	H.9
IE-BIC-HYB-P-0,2-300	1135160000	J.51
IE-BIC-HYB-P-0,5-300	1096150000	J.51
IE-BIC-HYB-P-0,75-300	1068970000	J.51
IE-BI-HYB-10P	1069010000	J.51
IE-BI-LCD-MMM-C	1964420000	J.56
IE-BI-LCD-SM-C	1962880000	J.56
IE-BI-RJ45-C	1962840000	J.49
IE-BI-RJ45-FJ-A	1962850000	J.48
IE-BI-RJ45-FJ-B	1963840000	J.48
IE-BI-RJ45-FJ-P	1963830000	J.48
IE-BI-SCRJ2SC-MMM-C	1964430000	J.54
IE-BI-SCRJ2SC-SM-C	1962870000	J.54
IE-BI-USB-3.0-A	1487920000	J.52

Type	Order No.	Page
IE-BI-USB-A	1019570000	J.52
IE-BI-USB-AB	1131380000	J.52
IE-BP-V01P	1965700000	N.21
IE-BP-V04P	1963900000	N.21
IE-BP-V05M	1968930000	N.21
IE-BP-V14P	1058310000	N.21
IE-BP-VAPP	1068930000	N.21
IE-BSC-V14M-LCD-MMM-C	1062610000	J.11
IE-BSC-V14M-LCD-SM-C	1062620000	J.11
IE-BSC-V14M-RJ45-C	1058250000	J.4
IE-BSC-V14M-RJ45-FJ-A	1058270000	J.3
IE-BSC-V14M-SCRJ-MMM-C	1062590000	J.11
IE-BSC-V14M-SCRJ-SM-C	1062600000	J.11
IE-BS-M12X-S-FH	1516340000	J.42
IE-BSS-V14M-HYB-10P-FJ	1072900000	J.7
IE-BSS-V14M-LCD-MMM-C	1058130000	J.11
IE-BSS-V14M-LCD-SM-C	1058150000	J.11
IE-BSS-V14M-RJ45-C	1012310000	J.4
IE-BSS-V14M-RJ45-FJ-A	1012320000	J.3
IE-BSS-V14M-RJ45-FJ-P	1085260000	J.3
IE-BSS-V14M-SCRJ-MMM-C	1058120000	J.11
IE-BSS-V14M-SCRJ-SM-C	1058140000	J.11
IE-BSS-VAPM-24V	1069030000	J.59
IE-BSS-VAPM-400V	1323950000	J.59
IE-BS-V01MLCD-MMM-C	1964440000	J.17
IE-BS-V01MLCD-SM-C	1963430000	J.17
IE-BS-V01M-RJ45-C	1963470000	J.13
IE-BS-V01M-RJ45-FJ-A	1963480000	J.13
IE-BS-V01M-SCRJ-MMM	1221010000	J.15
IE-BS-V01M-SCRJ-SM	1221020000	J.15
IE-BS-V01PRJ45-C	1012370000	J.19
IE-BS-V01PRJ45-FJ-A	1012380000	J.19
IE-BS-V04P-LCD-MMM-C	1964460000	J.29
IE-BS-V04P-LCD-SM-C	1963450000	J.29
IE-BS-V04P-RJ45-C	1963490000	J.23
IE-BS-V04P-RJ45-FJ-A	1963500000	J.23
IE-BS-V04P-RJ45-FJ-B	1963730000	J.23
IE-BS-V04P-SCRJ2SC-MMM-C	1964470000	J.27
IE-BS-V04P-SCRJ2SC-SM-C	1963420000	J.27
IE-BS-V05M-RJ45-C	1963510000	J.31
IE-BS-V05M-RJ45-FJ-A	1963460000	J.31
IE-BS-V05M-RJ45-FJ-P	1963700000	J.31
IE-CSAS4V1000	8959900000	L.14
IE-CSAS4V6-MW	8959950000	L.14
IE-C5CS8UG-MW	8944310000	L.6
IE-C5CS8V6-MW	8953160000	L.6
IE-C5DB4RE0015MCA-MCA-E	1059970015	L.41
IE-C5DB4RE0015MCA-XXX-X	1059990015	L.42
IE-C5DB4RE0015MCS-MCA-E	1059940015	L.41
IE-C5DB4RE0015MCS-XXX-X	1010850015	L.39
IE-C5DB4RE0015MCS-XXX-X	1010840015	L.40
IE-C5DB4RE0015MSS-MCS-E	1059340015	L.39
IE-C5DB4RE0030MCA-MCA-E	1059970030	L.41
IE-C5DB4RE0030MCA-XXX-X	1059990030	L.42
IE-C5DB4RE0030MCS-MCA-E	1059940030	L.41
IE-C5DB4RE0030MCS-XXX-X	1010850030	L.39
IE-C5DB4RE0030MSS-MCS-E	1059340030	L.39
IE-C5DB4RE0050MCA-MCA-E	1059970050	L.41
IE-C5DB4RE0050MCA-XXX-X	1059990050	L.42
IE-C5DB4RE0050MCS-MCA-E	1059940050	L.41
IE-C5DB4RE0050MCS-XXX-X	1010850050	L.39
IE-C5DB4RE0050MSS-MCS-E	1059340050	L.40
IE-C5DB4RE0100MCA-MCA-E	1059970100	L.41
IE-C5DB4RE0100MCA-XXX-X	1059990100	L.42
IE-C5DB4RE0100MCS-MCA-E	1059940100	L.41
IE-C5DB4RE0100MCS-XXX-X	1010850100	L.39
IE-C5DB4RE0100MSS-MCS-E	1059340100	L.39
IE-C5DB4WE0010A20A20-E	1421710010	L.44
IE-C5DB4WE0020A20A20-E	1421710020	L.44
IE-C5DB4WE0030A20A20-E	1421710030	L.44
IE-C5DB4WE0040MCSA20-E	1220310040	L.43
IE-C5DB4WE0050A20A20-E	1421710050	L.44
IE-C5DB4WE0050MCSXXX-E	1269740050	L.43
IE-C5DB4WE0100A20A20-E	1421710100	L.44
IE-C5DB4WE0100MCSXXX-E	1269740100	L.43
IE-C5DB4WE0200A20A20-E	1421710200	L.44
IE-C5DB4WE0200MCSA20-E	1421710200	L.44
IE-C5DB4U1000	8999010000	L.15
IE-C5DD4UG0005A20A20-E	1173030005	L.25
IE-C5DD4UG0005A20A20-E	1376510005	L.25
IE-C5DD4UG0005MCSMCS-E	1025950005	L.30
IE-C5DD4UG0010A20A20-E	1173030010	L.25
IE-C5DD4UG0010A20A20-E	1376510010	L.25
IE-C5DD4UG0010A2EA2E-X	1119730010	L.27
IE-C5DD4UG0010B2EB2E-X	1307610010	L.28
IE-C5DD4UG0010MCSA20-E	1044470010	L.31
IE-C5DD4UG0015MCA-MCA-E	1059890015	L.32
IE-C5DD4UG0015MCA-XXX-X	1059750015	L.33
IE-C5DD4UG0015MCSA20-E	1044470015	L.31
IE-C5DD4UG0015MCSMCS-E	1059770015	L.32
IE-C5DD4UG0015MSS-MCS-E	1025940015	L.31
IE-C5DD4UG0020A20A20-E	1173030020	L.25
IE-C5DD4UG0020A20A20-E	1376510020	L.25
IE-C5DD4UG0020A2EA2E-X	1119730020	L.27
IE-C5DD4UG0020B2EB2E-X	1307610020	L.28

Type	Order No.	Page
IE-C5DD4UG0030A20A20-E	1173030030	L.25
IE-C5DD4UG0030A2DA2D-E	1376510030	L.25
IE-C5DD4UG0030A2EA2E-X	1119730030	L.27
IE-C5DD4UG0030B2EB2E-X	1307610030	L.28
IE-C5DD4UG0030MCA-MCA-E	1059890030	L.32
IE-C5DD4UG0030MCA-XXX-X	1059750030	L.33
IE-C5DD4UG0030MCSA20-E	1044470030	L.31
IE-C5DD4UG0030MCSMCS-E	1059770030	L.32
IE-C5DD4UG0030MSS-MCS-E	1025950030	L.30
IE-C5DD4UG0030MSS-XXX-X	1025940030	L.31
IE-C5DD4UG0050MCA-MCS-E	1059330030	L.30
IE-C5DD4UG0050A20A20-E	1173030050	L.25
IE-C5DD4UG0050A2DA2D-E	1376510050	L.25
IE-C5DD4UG0050A2EA2E-X	1119730050	L.27
IE-C5DD4UG0050B2EB2E-X	1307610050	L.28
IE-C5DD4UG0050MCA-MCS-E	1059890050	L.32
IE-C5DD4UG0050MCA-XXX-X	1059750050	L.33
IE-C5DD4UG0050MCSA20-E	1044470050	L.31
IE-C5DD4UG0050MCSMCA-E	1059770050	L.32
IE-C5DD4UG0050MCSMCS-E	1025950050	L.30
IE-C5DD4UG0050MCSXXX-X	1025940050	L.31
IE-C5DD4UG0050MSSMCS-E	1059330050	L.30
IE-C5DD4UG0100A20A20-E	1173030100	L.25
IE-C5DD4UG0100A2DA2D-E	1376510100	L.25
IE-C5DD4UG0100A2EA2E-X	1119730100	L.27
IE-C5DD4UG0100B2EB2E-X	1307610100	L.28
IE-C5DD4UG0100MCA-MCA-E	1059890100	L.32
IE-C5DD4UG0100MCA-XXX-X	1059750100	L.33
IE-C5DD4UG0100MCSA20-E	1044470100	L.31
IE-C5DD4UG0100MCSMCS-E	1059770100	L.32
IE-C5DD4UG0100MCSMCS-E	1025950010	L.30
IE-C5DD4UG0100MSS-XXX-X	1025940010	L.31
IE-C5DD4UG0150MCSMCS-E	1059330010	L.30
IE-C5DD4UG020A20A20-E	1173030020	L.25
IE-C5DD4UG020A20A20-E	1376510020	L.25
IE-C5DD4UG020A2EA2E-X	1119730020	L.27
IE-C5DD4UG020B2EB2E-X	1307610020	L.28

Type	Order No.	Page	Type	Order No.	Page	Type	Order No.	Page
IE-C5IT4UG0020B2EB2E-X	1312690020	L 28	IE-C6FP8LR0100M40M40-R	1166030100	L 19	IE-CT-IC-GOF	9205330000	N.13
IE-C5IT4UG0030B2EB2E-X	1312690030	L 28	IE-C6FP8LR150M40M40-R	1166030150	L 19	IE-CT-SC-GOF	9205320000	N.13
IE-C5IT4UG0050B2EB2E-X	1312690050	L 28	IE-C6FP8LR200M40M40-R	1166030200	L 19	IE-DINRAILMOUNT-KT	1504430000	F.11
IE-C5IT4UG100B2EB2E-X	1312690100	L 28	IE-C6FP8LR250M40M40-R	1166030250	L 19	IE-DM	8813500000	H.16
IE-C5IT4UG-MW	1103010000	L 15	IE-C6FP8LY0002M40M40-Y	1251580020	L 20	IE-DM	8813500000	H.17
IE-C6ES8UG0010A40XCS-E	1457580010	L 37	IE-C6FP8LY0005M40M40-Y	1251580005	L 20	IE-DM	8813500000	H.20
IE-C6ES8UG0020A40XCS-E	1457580020	L 37	IE-C6FP8LY0010M40M40-Y	1251580010	L 20	IE-DPC	8813490000	N.21
IE-C6ES8UG0030A40XCS-E	1457580030	L 37	IE-C6FP8LY0015M40M40-Y	1251580015	L 20	IE-FCI-D25-FF	1450880000	L.10
IE-C6ES8UG0050A40XCS-E	1457580050	L 37	IE-C6FP8LY0020M40M40-Y	1251580020	L 20	IE-FCI-D25-FM	1450890000	L.10
IE-C6ES8UG010A40XCS-E	1457580100	L 37	IE-C6FP8LY0030M40M40-Y	1251580030	L 20	IE-FCI-D25-FS	1450900000	L.10
IE-C6ES8UG0120A40XCS-E	1457580120	L 37	IE-C6FP8LY0050M40M40-Y	1251580050	L 20	IE-FCI-D9-FF	1450840000	L.10
IE-C6FP8LB0002M40M40-B	1165900002	L 18	IE-C6FP8LY0100M40M40-Y	1251580100	L 20	IE-FCI-D9-FM	1450850000	L.10
IE-C6FP8LB0005M40M40-B	1165900005	L 18	IE-C6FP8LY0150M40M40-Y	1251580150	L 20	IE-FCI-D9-FS	1450870000	L.10
IE-C6FP8LB0010M40M40-B	1165900010	L 18	IE-C6FP8LY0200M40M40-Y	1251580200	L 20	IE-FCI-HD15-FF	1556290000	L.11
IE-C6FP8LB0015M40M40-B	1165900015	L 18	IE-C6FP8LY0250M40M40-Y	1251580250	L 20	IE-FCI-HDMI-FF	2003390000	L.11
IE-C6FP8LB0020M40M40-B	1165900020	L 18	IE-C6FS8UG0003A40A40-G	8941350003	L 24	IE-FCI-IP-1ST/1D9/1D25	1450650000	L.14
IE-C6FP8LB0030M40M40-B	1165900030	L 18	IE-C6FS8UG0005A40A40-G	8941350005	L 24	IE-FCI-IP-2ST/2D9	1450670000	L.14
IE-C6FP8LB0050M40M40-B	1165900050	L 18	IE-C6FS8UG0010A40A40-G	8941350010	L 24	IE-FCI-IP-BP	1450710000	L.6
IE-C6FP8LB0100M40M40-B	1165900100	L 18	IE-C6FS8UG0015A40A40-G	8941350015	L 24	IE-FCI-IP-PWB/2ST	1450630000	L.3
IE-C6FP8LB0150M40M40-B	1165900150	L 18	IE-C6FS8UG0020A40A40-G	8941350020	L 24	IE-FCI-IP-PWS/2D9	1450680000	L.7
IE-C6FP8LB0200M40M40-B	1165900200	L 18	IE-C6FS8UG0030A40A40-G	8941350030	L 24	IE-FCI-IP-PWS/2ST/1D9	1450690000	L.3
IE-C6FP8LB0250M40M40-B	1165900250	L 18	IE-C6FS8UG0050A40A40-G	8941350050	L 24	IE-FCI-IP-PWS/4ST	1450640000	L.7
IE-C6FP8LB0002M40M40-D	1165940002	L 17	IE-C6FS8UG0100A40A40-G	8941350100	L 24	IE-FCI-IP-PWU/1ST/CB	1543710000	L.5
IE-C6FP8LD0003X40X40-Y	1312160003	L 22	IE-C6FS8UG0150A40A40-G	8941350150	L 24	IE-FCI-IP-PWU/2ST	1450700000	L.5
IE-C6FP8LD0004X40X40-Y	1312160004	L 22	IE-C6FS8UG0200A40A40-G	8941350200	L 24	IE-FCI-PWB-AU	1450830000	L.15
IE-C6FP8LD0005M40M40-D	1165940005	L 17	IE-C6K8SVG0005XCSXCS-E	1398070005	L 36	IE-FCI-PWB-AU-10A	1546590000	L.15
IE-C6FP8LD0005M40V40-D	1248280005	L 21	IE-C6K8SVG0005XCSXXX-E	1449470005	L 36	IE-FCI-PWB-CH	1450780000	L.13
IE-C6FP8LD0005M40W40-D	1233160005	L 21	IE-C6K8SVG0015XCSXCS-E	1398070015	L 36	IE-FCI-PWB-CN	1450790000	L.16
IE-C6FP8LD0005X40X40-Y	1312160005	L 22	IE-C6K8SVG0015XCSXXX-E	1449470015	L 36	IE-FCI-PWB-DE	1450730000	L.12
IE-C6FP8LD0010M40M40-D	1165940010	L 17	IE-C6K8SVG0030XCSXCS-E	1398070030	L 36	IE-FCI-PWB-DE-OR	1564000000	L.12
IE-C6FP8LD0010M40V40-D	1248280010	L 21	IE-C6K8SVG0050XCSXCS-E	1398070050	L 36	IE-FCI-PWB-FR	1450750000	L.13
IE-C6FP8LD0010M40W40-D	1233160010	L 21	IE-C6K8SVG0050XCSXXX-E	1449470050	L 36	IE-FCI-PWB-FR-OR	2007230000	L.13
IE-C6FP8LD0010X40X40-Y	1312160010	L 22	IE-C6K8SVG0100XCSXCS-E	1398070100	L 36	IE-FCI-PWB-GB	1450770000	L.14
IE-C6FP8LD0012M40V40-D	1248280012	L 21	IE-C6K8SVG0100XCSXXX-E	1449470100	L 36	IE-FCI-PWB-MC	1529570000	L.17
IE-C6FP8LD0012M40W40-D	1233160012	L 21	IE-C7B88B-MW	8955350000	L 7	IE-FCI-PWB-RCBO	1534250000	L.18
IE-C6FP8LD0015M40M40-D	1165940015	L 17	IE-C7B88B-MW	8955360000	L 7	IE-FCI-PWB-3A	1543690000	L.19
IE-C6FP8LD0015M40V40-D	1248280015	L 21	IE-C7ES8UG-MW	8954300000	L 9	IE-FCI-PWS-EU	1450740000	L.15
IE-C6FP8LD0015M40W40-D	1233160015	L 21	IE-C7ES8UG-MW	8954800000	L 9	IE-FCI-PWS-IT	1450810000	L.14
IE-C6FP8LD0020M40M40-D	1165940020	L 17	IE-C7FS8LB-305M	1326540000	L 10	IE-FCI-PWS-US	1450800000	L.16
IE-C6FP8LD0020M40V40-D	1248280020	L 21	IE-C7FS8LD-305M	1273090000	L 10	IE-FCI-KEY	1465930000	L.2
IE-C6FP8LD0020M40W40-D	1233160020	L 21	IE-C7FS8LE-305M	1346890000	L 11	IE-FCM-RJ45-C	1018790000	L.25
IE-C6FP8LD0020X40X40-Y	1312160020	L 22	IE-C7FS8LG-305M	1346880000	L 11	IE-FCM-RJ45-FJ-A	1018810000	L.24
IE-C6FP8LD0030M40M40-D	1165940030	L 17	IE-C7FS8LM-305M	1333160000	L 12	IE-FCM-RJ45-FJ-B	1018820000	L.24
IE-C6FP8LD0030M40V40-D	1248280030	L 21	IE-C7FS8LR-305M	1287910000	L 11	IE-FCM-RJ45-FJ-P	1018830000	L.24
IE-C6FP8LD0030M40W40-D	1233160030	L 21	IE-C7FS8LJ-305M	1344670000	L 12	IE-FCM-USB-3.0-A	1427960000	L.26
IE-C6FP8LD0030X40X40-Y	1312160030	L 22	IE-CC-8W-FA-IP67	1499940000	N.3	IE-FCM-USB-A	1018840000	L.26
IE-C6FP8LD0050M40M40-D	1165940050	L 17	IE-CC-NM-RPSMAM-2M	1367110000	F.4	IE-FCM-USB-AB	1222550000	L.26
IE-C6FP8LD0050M40V40-D	1248280050	L 21	IE-CC-NM-RPSMAM-4M	1367100000	F.4	IE-FC-PWPC	1450820000	L.20
IE-C6FP8LD0050M40W40-D	1233160050	L 21	IE-CC-NM-SMAM-2M	1491180000	F.7	IE-FC-SET-IPDEX001-KY-P	1543680000	L.22
IE-C6FP8LD0050X40X40-Y	1312160050	L 22	IE-CC-NM-SMAM-4M	1491190000	F.7	IE-FC-SET-SPDED001-KN-P	1529580000	L.21
IE-C6FP8LD0075M40M40-D	1165940075	L 17	IE-CC-NM-SMAM-6M	1491210000	F.7	IE-FC-SET-SPMCK001-KY-P	1989020000	L.22
IE-C6FP8LD0100M40M40-D	1165940100	L 17	IE-CC-V01P	1061820000	J.20	IE-FC-SET-SPDCD002-KY-M	1529390000	L.21
IE-C6FP8LD0100M40V40-D	1248280100	L 21	IE-CC-V04P	1045960000	J.24	IE-FC-SFM-KEY	1450540000	L.2
IE-C6FP8LD0100M40W40-D	1233160100	L 21	IE-CC-V14M-HYB-10P-FJ	1990610000	K.7	IE-FC-SFM-KNOB	1450530000	L.2
IE-C6FP8LD0100X40X40-Y	1312160100	L 22	IE-CC-V14M-MF	1990620000	K.3	IE-FC-SFP-KEY	1450520000	L.2
IE-C6FP8LD0150M40M40-D	1165940150	L 17	IE-CC-V14M-MF	1990620000	K.7	IE-FC-SFP-KNOB	1450510000	L.2
IE-C6FP8LD0150X40X40-Y	1312160150	L 22	IE-CC-V14M-RJ45-FJ-P	1990600000	K.3	IE-FC-SP-1ST/1D9/1D25	1450580000	L.4
IE-C6FP8LD0200M40M40-D	1165940200	L 17	IE-CC-VAPM-24V	1990630000	K.3	IE-FC-SP-2ST/2D9	1450590000	L.6
IE-C6FP8LD0200X40X40-Y	1312160200	L 22	IE-CC-VAPM-FM	1990640000	K.3	IE-FC-SP-PWB/2ST	1450550000	L.13
IE-C6FP8LD0250M40M40-D	1165940250	L 17	IE-CD-MA	1095880000	K.2	IE-FC-SP-PWS/2D9	1450610000	L.7
IE-C6FP8LE0002M40M40-E	1251610002	L 18	IE-CD-MA	1095890000	K.2	IE-FC-SP-PWS/2ST/1D9	1450600000	L.3
IE-C6FP8LE0005M40M40-E	1251610005	L 18	IE-CDM-V14MRJSCP/VAPM-C	1324440000	K.9	IE-FC-SP-PWS/4ST	1450570000	L.7
IE-C6FP8LE0010M40M40-E	1251610010	L 18	IE-CDR-V14MSCPOF/VAPM-C	1253240000	K.9	IE-FC-SP-PWU/2ST	1450620000	L.5
IE-C6FP8LE0015M40M40-E	1251610015	L 18	IE-CD-V04PJRJ-C-MA	1122710000	K.13	IE-FISP-V4	9204370000	N.16
IE-C6FP8LE0020M40M40-E	1251610020	L 18	IE-CD-V14MHYB-10P-C-MA	1068840000	K.8	IE-FM5C2UE-MW	8956070000	M.5
IE-C6FP8LE0030M40M40-E	1251610030	L 18	IE-CD-V14MHYB-10P-FJ	1068850000	K.7	IE-FM5D2UE0001MDS0SDOX	8876430010	M.14
IE-C6FP8LE0050M40M40-E	1251610050	L 18	IE-CD-V14MRJ/VAPM24V-C-MA	1068820000	K.4	IE-FM5D2UE0001MSTOSTOX	8876450010	M.14
IE-C6FP8LE0100M40M40-E	1251610100	L 18	IE-CD-V14MRJ/VAPM24V-FJ	1068830000	K.2	IE-FM5D2UE0003MDS0SDOX	8876430030	M.14
IE-C6FP8LE0150M40M40-E	1251610150	L 18	IE-CD-V14MRJ-C-MA	1068870000	K.4	IE-FM5D2UE0003MSTOSTOX	8876450030	M.14
IE-C6FP8LE0200M40M40-E	1251610200	L 18	IE-CD-V14MRJ-FJ	1068880000	K.2	IE-FM5D2UE0005MDS0SDOX	8876430050	M.14
IE-C6FP8LE0250M40M40-E	1251610250	L 18	IE-CD-V14MSCRJ-MM-C-MA	1318150000	K.5	IE-FM5D2UE0005MSTOSTOX	8876450050	M.14
IE-C6FP8LG0002M40M40-G	1251590002	L 19	IE-CD-VAPM24V-C-MA	1397690000	K.6	IE-FM5D2UE0010MLDLDLDOX	8979020000	M.13
IE-C6FP8LG0005M40M40-G	1251590005	L 19	IE-CD-VAPM24V-Y-MA	1297010000	K.6	IE-FM5D2UE0010MDS0SDOX	8876430100	M.14
IE-C6FP8LG0010M40M40-G	1251590010	L 19	IE-CP67	8813090000	J.34	IE-FM5D2UE0010MSTOSTOX	8876450100	M.14
IE-C6FP8LG0015M40M40-G	1251590015	L 19	IE-CL240W-PP-Base	1547440000	K.10	IE-FM5D2UE0050MLDLDLDOX	8979040000	M.13
IE-C6FP8LG0020M40M40-G	1251590020	L 19	IE-CL240W-PP-REMOTE	1547450000	K.10	IE-FM5D2UE0050MSTOSTOX	8876450500	M.14
IE-C6FP8LG0030M40M40-G	1251590030	L 19	IE-CR-IP20-RJ45-FH-BU	1963080000	H.2	IE-FM5D2UE0100MLDLDLDOX	8979030000	M.13
IE-C6FP8LG0050M40M40-G	1251590050	L 19	IE-CR-IP20-RJ45-FH-HG	1963100000	H.2	IE-FM5D2UE0100MDS0SDOX	8876431000	M.14
IE-C6FP8LG0100M40M40-G	1251590100	L 19	IE-CR-IP20-RJ45-FH-GY	1963060000	H.2	IE-FM5D2UE0100MSTOSTOX	8876451000	M.14
IE-C6FP8LG0150M40M40-G	1251590150	L 19	IE-CR-IP20-RJ45-FH-WH	1963070000	H.2	IE-FM5D2UE-MW	8946000000	M.5
IE-C6FP8LG0200M40M40-G	1251590200	L 19	IE-CR-IP20-RJ45-FH-WH	1963050000	H.2	IE-FM5Z2L00001MLDLDLDOX	1433940010	M.8
IE-C6FP8LG0250M40M40-G	1251590250	L 19	IE-CR-IP20-RJ45-FH-YE	1963090000	H.2	IE-FM5Z2L00001MDS0SDOX	1433970010	M.7
IE-C6FP8LM0002M40M40-M	1201270002	L 20	IE-CS-2TX-1RS232/485	1242080000	D.5	IE-FM5Z2L00001MSTOSTOX	1433990010	M.7
IE-C6FP8LM0005M40M40-M	1201270005	L 20	IE-CS-2TX-2RS232/485	1242090000	D.5	IE-FM5Z2L00002MLDLDLDOX	1433940020	M.8
IE-C6FP8LM0010M40M40-M	1201270010	L 20	IE-CSPD5US0050VAPVAP-X	1403680050	L 29	IE-FM5Z2L00002MDS0SDOX	1433970050	M.7
IE-C6FP8LM0015M40M40-M	1201270015	L 20	IE-CSPD5US0100VAPVAP-X	1403680100	L 29	IE-FM5Z2L00002MSTOSTOX	1433990020	M.7
IE-C6FP8LM0020M40M40-M	1201270020	L 20	IE-CSPD5US0150VAPVAP-X	1403680150	L 29	IE-FM5Z2L00003MLDLDLDOX	1433940030	M.8
IE-C6FP8LM0030M40M40-M	1201270030	L 20	IE-CSP5SVS0010VAPVAP-X	1350120010	L 29	IE-FM5Z2L00003MDS0SDOX	1433970030	M.7
IE-C6FP8LM0050M40M40-M	1201270050	L 20	IE-CSP5SVS0030VAPVAP-X	1350120030	L 29	IE-FM5Z2L00003MSTOSTOX	1433990030	M.7
IE-C6FP8LM0100M40M40-M	1201270100	L 20	IE-CSP5SVS0050VAPVAP-X	1350120050	L 29	IE-FM5Z2L00005MLDLDLDOX	1433940050	M.8
IE-C6FP8LM0150M40M40-M	1201270150	L 20	IE-CSP5SVS0100VAPVAP-X	1350120100	L 29	IE-FM5Z2L00005DSDSDOX	1433970050	M.7
IE-C6FP8LM0200M40M40-M	1201270200	L 20	IE-CSP5SVS0150VAPVAP-X	1350120150	L 29	IE-FM5Z2L00005MSTOSTOX	1433990050	M.7
IE-C6FP8LR0002M40M40-R	1166030002	L 19	IE-CSP5SVS0200VAPVAP-X	1350120200	L 29	IE-FM5Z2L00005MLDLDLDOX	1433940050	M.8
IE-C6FP8LR0005M40M40-R	1166030005	L 19	IE-CT	9204350000	N.4	IE-FM5Z2L00005MDS0SDOX	1433970050	M.7
IE-C6FP8LR0								

Type	Order No.	Page	Type	Order No.	Page	Type	Order No.	Page
IE-FM5Z2V00001MSDOSDOX	8813300000	M.10	IE-MC-VLT-1TX-1ST	1286890000	D.3	IE-PS-RJ45-FH-BK-P	1132060000	H.2
IE-FM5Z2V00002MLDOLDX	1062570000	M.11	IE-OM-V01M-K11-1S	1966300000	K.12	IE-PS-RJ45-TH-BK	1963590000	H.6
IE-FM5Z2V00002MSDOSDOX	8813310000	M.10	IE-OM-V01M-K21-2S	1966330000	K.12	IE-PS-SCD-MM	1964480000	H.8
IE-FM5Z2V00002MSTOSTOX	8813390000	M.11	IE-OM-V04P-K11-1S	1966220000	K.14	IE-PS-SCD-SM	1964410000	H.8
IE-FM5Z2V00003MSDOSDOX	8813320000	M.10	IE-OM-V04P-K21-2S	1966250000	K.14	IE-PS-SCRJ1-MM	1206730000	H.7
IE-FM5Z2V00005MLDOLDX	1062550000	M.11	IE-OM-V05M-K11-1S	1966280000	K.15	IE-PS-SCRJ1-PDF	1206720000	H.7
IE-FM5Z2V00005MSDOSDOX	8876350050	M.10	IE-OM-V05M-K21-2S	1966290000	K.15	IE-PS-SCRJ1-SM	1206740000	H.7
IE-FM5Z2V00005MSTOSTOX	8876370050	M.10	IE-OP-V01P-1S	1061830000	K.11	IE-PS-ST-MM	1968150000	H.7
IE-FM5Z2V00010MLDOLDX	1062580000	M.11	IE-OP-V04P-1S	1045780000	K.13	IE-PS-V01M-2LC-MM	1963220000	J.16
IE-FM5Z2V00010MSDOSDOX	8876350100	M.10	IE-P	8813100000	H.6	IE-PS-V01M-2LC-MM-BP	1963230000	J.16
IE-FM5Z2V00010MSTOSTOX	8876370100	M.10	IE-P63	8813110000	H.6	IE-PS-V01M-2LC-SM	1963240000	J.16
IE-FM6C2UE0100MSD1SD1X	1318011000	M.15	IE-P70	8813120000	H.6	IE-PS-V01M-2LC-SM-BP	1963250000	J.16
IE-FM6C2UE0180MSD1SD1X	1318011800	M.15	IE-PCB2-M12X-S-180	1393080000	J.44	IE-PS-V01M-2SC-MM	1963260000	J.14
IE-FM6C2UE0200MSD1SD1X	1318012000	M.15	IE-PCB-M12X-S-180	1324010000	J.44	IE-PS-V01M-2SC-MM-BP	1963270000	J.14
IE-FM6C2UE0250MSD1SD1X	1318012500	M.15	IE-PCB-M12X-S-90	2168220000	J.45	IE-PS-V01M-2SC-SM	1963300000	J.14
IE-FM6C2UE0300MSD1SD1X	1318013000	M.15	IE-PCBR2-M12X-S-180	1444650000	J.44	IE-PS-V01M-2SC-SM-BP	1963310000	J.14
IE-FM6C2UE0350MSD1SD1X	1318013500	M.15	IE-PCB-RJ45-SMD-C5-A	1433890000	H.12	IE-PS-V01M-RJ45-FH	1963120000	J.12
IE-FM6C2UE0500MSD1SD1X	1318015000	M.15	IE-PCB-RJ45-SMD-C5-AI	1455220000	H.12	IE-PS-V01M-RJ45-FH-BP	1963130000	J.12
IE-FM6C2UE-MW	8956050000	M.5	IE-PCB-RJ45-SMD-C5-S	1433900000	H.13	IE-PS-V01M-RJ45-TH	1963140000	J.12
IE-FM6D2UE0001MSDOSDOX	8876440010	M.14	IE-PCB-RJ45-THR-C5-A	1433800000	H.10	IE-PS-V01M-RJ45-TH-BP	1963150000	J.12
IE-FM6D2UE0001MSTOSTOX	8876460010	M.14	IE-PCB-RJ45-THR-C5-AI	1455240000	H.10	IE-PS-V01P-RJ45-FH	1012490000	J.18
IE-FM6D2UE0003MSDOSDOX	8876440030	M.14	IE-PCB-RJ45-THR-C5-S	1433810000	H.11	IE-PS-V01P-RJ45-FH-BP	1012570000	J.18
IE-FM6D2UE0003MSTOSTOX	8876460030	M.14	IE-PCB-RJ45-THR-C6-A	1433910000	H.14	IE-PS-V01P-RJ45-TH	1012470000	J.18
IE-FM6D2UE0005MLDOLDX	1220930000	M.13	IE-PCB-RJ45-THR-C6-S	1433920000	H.14	IE-PS-V01P-RJ45-TH-BP	1012560000	J.18
IE-FM6D2UE0005MSDOSDOX	8876440050	M.14	IE-PCBR-M12X-S-180	1427670000	J.44	IE-PS-V04P-2LC-MM	1963320000	J.28
IE-FM6D2UE0005MSTOSTOX	8876460050	M.14	IE-PH-AD-V05M-RJ45	1993540000	J.30	IE-PS-V04P-2LC-MM-BP	1963330000	J.28
IE-FM6D2UE0010MSDOSDOX	8876440100	M.14	IE-PH-RJ45-TH-BK	1962500000	H.6	IE-PS-V04P-2LC-SM	1963340000	J.28
IE-FM6D2UE0010MSTOSTOX	8876460100	M.14	IE-PH-RJ45-TH-BU	1962470000	H.6	IE-PS-V04P-2LC-SM-BP	1963350000	J.28
IE-FM6D2UE0020MLDOLDX	1174830000	M.13	IE-PH-RJ45-TH-GN	1962490000	H.6	IE-PS-V04P-2SC-MM	1963360000	J.26
IE-FM6D2UE0050MLDOLDX	8932200000	M.13	IE-PH-RJ45-TH-GY	1962440000	H.6	IE-PS-V04P-2SC-MM-BP	1963370000	J.26
IE-FM6D2UE-MW	8956060000	M.5	IE-PH-RJ45-TH-OG	1962450000	H.6	IE-PS-V04P-2SC-SM	1963400000	J.26
IE-FM6Z2L00001MLDOLDX	1433930010	M.8	IE-PH-RJ45-TH-WH	1962430000	H.6	IE-PS-V04P-2SC-SM-BP	1963410000	J.26
IE-FM6Z2L00001MSDOSDOX	1433960010	M.7	IE-PH-RJ45-TH-YE	1962480000	H.6	IE-PS-V04P-RJ45-FH-B	1963160000	J.22
IE-FM6Z2L00001MSTOSTOX	1433980010	M.7	IE-PH-V01M	1962550000	J.12	IE-PS-V04P-RJ45-FH-BP	1271240000	J.22
IE-FM6Z2L00002MLDOLDX	1433930020	M.8	IE-PH-V01M	1962550000	J.14	IE-PS-V04P-RJ45-FH-P	1963170000	J.22
IE-FM6Z2L00002MSDOSDOX	1433960020	M.7	IE-PH-V01M	1962550000	J.16	IE-PS-V04P-RJ45-TH	1963180000	J.22
IE-FM6Z2L00002MSTOSTOX	1433980020	M.7	IE-PH-V01M-BP	1962560000	J.12	IE-PS-V04P-RJ45-TH-BP	1963190000	J.22
IE-FM6Z2L00003MLDOLDX	1433930030	M.8	IE-PH-V01M-BP	1962560000	J.14	IE-PS-V05M-A-RJ45-FH	1077300000	J.30
IE-FM6Z2L00003MSDOSDOX	1433960030	M.7	IE-PH-V01M-BP	1962560000	J.16	IE-PS-V05M-RJ45-FH	1963200000	J.30
IE-FM6Z2L00003MSTOSTOX	1433980030	M.7	IE-PH-V01P	1012440000	J.18	IE-PS-V05M-RJ45-FH-B	1271250000	J.30
IE-FM6Z2L00005DLDOLDX	1433930005	M.8	IE-PH-V01P-BP	1012460000	J.18	IE-PS-V05M-RJ45-TH	1963110000	J.30
IE-FM6Z2L00005DSDOSDOX	1433960005	M.7	IE-PH-V04P	1962520000	J.22	IE-PS-V14M-2SC-POF	1191550000	J.10
IE-FM6Z2L00005DSTOSTOX	1433980005	M.7	IE-PH-V04P	1962520000	J.26	IE-PS-V14M-HYB-10P	1072910000	J.6
IE-FM6Z2L00005MLDOLDX	1433930050	M.8	IE-PH-V04P	1962520000	J.28	IE-PS-V14M-RJ45-FHP	1012170000	J.2
IE-FM6Z2L00005MSDOSDOX	1433960050	M.7	IE-PH-V04P-BP	1962530000	J.22	IE-PS-V14M-RJ45-TH	1012160000	G.8
IE-FM6Z2L00005MSTOSTOX	1433980050	M.7	IE-PH-V04P-BP	1962530000	J.26	IE-PS-VAPM-24V	1068910000	J.58
IE-FM6Z2L00010MLDOLDX	1433930100	M.8	IE-PH-V04P-BP	1962530000	J.28	IE-PS-VAPM-400V	1323940000	J.58
IE-FM6Z2L00010MSDOSDOX	1433960100	M.7	IE-PH-V05M	1962540000	J.30	IE-SCRJ1-IP20-POF-100	1278420000	H.7
IE-FM6Z2L00010MSTOSTOX	1433980100	M.7	IE-PH-V14M-FO	1058100000	J.10	IE-SCRJ1-IP67-POF-100	1278430000	J.53
IE-FM6Z2V00001MLDOLDX	1296450000	M.11	IE-PH-V14M-RJ	1011560000	J.2	IE-SFP-1FEUCLT	1241480000	F.8
IE-FM6Z2V00001MSDOSDOX	8813330000	M.10	IE-PH-V14M-RJ	1011560000	J.6	IE-SFP-1FEMCLT	1241450000	F.8
IE-FM6Z2V00001MSTOSTOX	8813270000	M.10	IE-PI-2LC-MM	1962780000	J.55	IE-SFP-1FESCLT	1241470000	F.8
IE-FM6Z2V00002MSDOSDOX	8813340000	M.10	IE-PI-2LC-SM	1962790000	J.55	IE-SFP-1GLHXLC	1241520000	F.8
IE-FM6Z2V00002MSTOSTOX	8813400000	M.11	IE-PICHYB-S-Q,2-300	1135150000	J.50	IE-SFP-1GLXCLT	1286730000	F.8
IE-FM6Z2V00002MSTOSTOX	8813280000	M.10	IE-PICHYB-S,0,5-300	1096180000	J.50	IE-SFP-1GLSCLT	1241500000	F.8
IE-FM6Z2V00003MSDOSDOX	8813350000	M.10	IE-PICHYB-S,0,75-300	1068950000	J.50	IE-SFP-1GLSXCLT	1286710000	F.8
IE-FM6Z2V00003MSTOSTOX	8813290000	M.10	IE-PH-HYB-10P	1068990000	J.50	IE-SFP-1GLXCLT	1241510000	F.8
IE-FM6Z2V00005MSDOSDOX	8876360050	M.10	IE-PI-IP67	8808380000	J.32	IE-SFP-1GLXCLT	1286720000	F.8
IE-FM6Z2V00005MSTOSTOX	8876380050	M.10	IE-PI-RJ45-FH	1962730000	J.46	IE-SFP-1GSXCLT	1241490000	F.8
IE-FM6Z2V00010MSDOSDOX	8876360100	M.10	IE-PI-RJ45-FHA	1132010000	J.46	IE-SFP-1GSXCLT	1286700000	F.8
IE-FM6Z2V00010MSTOSTOX	8876380100	M.10	IE-PI-RJ45-FHA-1.1	1992920000	H.3	IE-S-IP67	8808370000	K.16
IE-FP0D2UE-MW	1172800000	M.6	IE-PI-RJ45-FHA-1.1	1992920000	H.4	IE-SR-2GT-LAN	1345270000	C.6
IE-FP0D2UG-MW	1398770000	M.6	IE-PI-RJ45-FHA-1.6	1992880000	H.3	IE-SR-2GT-LAN-FN	1489940000	C.6
IE-FP0Z2EE0001MSJOSJ-X	1273430010	M.12	IE-PI-RJ45-FHA-1.6	1992880000	H.4	IE-SR-2GT-UMTS/3G	1345250000	C.6
IE-FP0Z2EE0003MSJOSJ-X	1273430030	M.12	IE-PI-RJ45-FH-B	1132020000	J.46	IE-SW-BL05-1GS-4GTPOE	1504360000	B.22
IE-FP0Z2EE0005MSJOSJ-X	1273430050	M.12	IE-PI-RJ45-FH-B-1.1	1992930000	H.3	IE-SW-BL05-1GT-4GTPOE	1504320000	B.22
IE-FP0Z2EE0010MSJOSJ-X	1273430100	M.12	IE-PI-RJ45-FH-B-1.1	1992930000	H.4	IE-SW-BL05-5GT	1241250000	B.6
IE-FP0Z2EE0020MSJOSJ-X	1273430200	M.12	IE-PI-RJ45-FH-B-1.6	1992900000	H.3	IE-SW-BL05T-1GS-4GTPOE	1504380000	B.22
IE-FP0Z2EE-MW	1242820000	M.6	IE-PI-RJ45-FH-B-1.6	1992900000	H.4	IE-SW-BL05T-1GT-4GTPOE	1504340000	B.22
IE-FSMD2UE0005MSDESDEX	1449420050	M.16	IE-PI-RJ45-FHP	1132030000	J.46	IE-SW-BL05T-5GT	1286850000	B.6
IE-FSMD2UE0020MSDESDEX	1449420200	M.16	IE-PI-RJ45-FHP-1.6	1992910000	H.5	IE-SW-BL06-1TX-4POE-1SC	1504250000	B.21
IE-FSMD2UE0025MSDESDEX	1449420250	M.16	IE-PI-RJ45-FHP-P.1.6	1992910000	H.5	IE-SW-BL06-1TX-4POE-1ST	1504270000	B.21
IE-FSMD2UE0040MSDESDEX	1449420400	M.16	IE-PI-RJ45-TH	1962720000	J.47	IE-SW-BL06-2TX-4POE	1241380000	B.21
IE-FSMZ2LY0001MLDOLDX	1433950010	M.9	IE-PI-SCRJ-MM	1067380000	J.53	IE-SW-BL06-4POE-2SC	1504210000	B.21
IE-FSMZ2LY0002MLDOLDX	1433950020	M.9	IE-PI-SCRJ-PDF	1067410000	J.53	IE-SW-BL06-4POE-2ST	1504230000	B.21
IE-FSMZ2LY0003MLDOLDX	1433950030	M.9	IE-PI-SCRJ-SM	1067390000	J.53	IE-SW-BL06T-1TX-4POE-1SC	1504260000	B.21
IE-FSMZ2LY0005DLDOLDX	1433950005	M.9	IE-PM-RJ45-TH	1963580000	H.6	IE-SW-BL06T-1TX-4POE-1ST	1504290000	B.21
IE-FSMZ2LY0005MLDOLDX	1433950050	M.9	IE-PP-V01P	1965690000	N.21	IE-SW-BL06T-2TX-4POE	1286920000	B.21
IE-FSMZ2LY0010MLDOLDX	1433950100	M.9	IE-PP-V04P	1963890000	N.21	IE-SW-BL06T-4POE-2SC	1504220000	B.21
IE-GW-MB-2TX-1RS232/485	1504460000	D.8	IE-PP-V05M	1968920000	N.21	IE-SW-BL06T-4POE-2ST	1504240000	B.21
IE-GWT-MB-2TX-1RS232/485	1504470000	D.8	IE-PP-V14P	1058280000	N.21	IE-SW-IP67-5M12	1504410000	B.5
IE-KO-HAT	1966810000	N.17	IE-PS-LCD-MM	1962970000	H.8	IE-SW-IP67T-5M12	1504420000	B.5
IE-KOK-V1	1966780000	N.17	IE-PS-LCD-SM	1962980000	H.8	IE-SW-PL06M-2TX-4POE	1241390000	B.23
IE-KOK-V14	1135240000	N.17	IE-PS-M12X-P-AWG22/27FH	2007500000	J.41	IE-SW-PL06MT-2TX-4POE	1286910000	B.23
IE-KOK-V4	1966790000	N.17	IE-PS-M12X-P-FH	1324020000	J.41	IE-SW-PL08M-6TX-2SC	1241070000	B.15
IE-KOK-V5	9204790000	N.17	IE-PS-M12X-S-FH	1516330000	J.42	IE-SW-PL08M-6TX-2SCS	1241090000	B.15
IE-M12-ADAP A	8901630000	J.38	IE-PS-RJ45-FH-180-A-1.1	1992850000	H.3	IE-SW-PL08M-6TX-2ST	1241080000	B.15
IE-M12-ADAP S	8901620000	J.38	IE-PS-RJ45-FH-180-A-1.6	1992820000	H.3	IE-SW-PL08M-8TX	1241040000	B.15
IE-M12-COUP	8901640000	J.39	IE-PS-RJ45-FH-180-B-1.1	1992860000	H.3	IE-SW-PL08MT-6TX-2SC	1286790000	B.15
IE-M12-PCBCE	8902810000	J.40	IE-PS-RJ45-FH-180-B-1.6	1992830000	H.3	IE-SW-PL08MT-6TX-2SCS	1286810000	B.15
IE-M12-PCBCE-PANEL	8902820000	J.40	IE-PS-RJ45-FH-180-P-1.6	1992840000	H.5	IE-SW-PL08MT-6TX-2ST	1286800000	B.15
IE-M12-PCBCE-PANEL A	1393470000	J.40	IE-PS-RJ45-FH-90-A-1.1	1518080000	H.4	IE-SW-PL08MT-8TX	1286780000	B.15
IE-MCT-1RS232/485-1SC	1344760000	D.7	IE-PS-RJ45-FH-90-A-1.6	1992870000	H.4	IE-SW-PL09M-5GC-4GT	1241370000	B.18
IE-MCT-1RS232/485-1ST	1362950000	D.7	IE-PS-RJ45-FH-90-B-1.1	1518090000	H.4	IE-SW-PL09MT-5GC-4GT	1287020000	B.18
IE-MC-VLT-1TX-1SC	1241400000	D.3	IE-PS-RJ45-FH-90-B-1.6	1992890000	H.4	IE-SW-PL10M-1GT-2GS-7TX	1241300000	B.16
IE-MC-VLT-1TX-1SCS	1241420000	D.3	IE-PS-RJ45-FH-90-P-1.6	1518100000	H.5	IE-SW-PL10M-3GT-7TX	1241290000	B.16
IE-MC-VLT-1TX-1ST	1241410000	D.3	IE-PS-RJ45-FH-BK	1963600000	H.2	IE-SW-PL10MT-1GT-2GS-7TX	1286940000	B.16
IE-MC-VLT-1TX-1SC	128							

Type	Order No.	Page
IE-SW-PL16M-14TX-2ST	1241130000	B.15
IE-SW-PL16M-16TX	1241100000	B.15
IE-SW-PL16MT-14TX-2SC	1286830000	B.15
IE-SW-PL16MT-14TX-2ST	1286840000	B.15
IE-SW-PL16MT-16TX	1286820000	B.15
IE-SW-PL18M-26C14TX2SC	1241330000	B.17
IE-SW-PL18M-26C14TX2SCS	1241350000	B.17
IE-SW-PL18M-26C14TX2ST	1241340000	B.17
IE-SW-PL18M-26C-16TX	1241320000	B.17
IE-SW-PL18MT-26C14TX2SC	1286990000	B.17
IE-SW-PL18MT-26C14TX2SCS	1287010000	B.17
IE-SW-PL18MT-26C14TX2ST	1287000000	B.17
IE-SW-PL18MT-26C-16TX	1286970000	B.17
IE-SW-VL05M-3TX-2SC	1504330000	B.13
IE-SW-VL05M-3TX-2ST	1504370000	B.13
IE-SW-VL05M-5TX	1504280000	B.13
IE-SW-VL05MT-3TX-2SC	1504350000	B.13
IE-SW-VL05MT-3TX-2ST	1504390000	B.13
IE-SW-VL05MT-5TX	1504310000	B.13
IE-SW-VL08-6GT-2GS	1241280000	B.6
IE-SW-VL08-8GT	1241270000	B.6
IE-SW-VL08MT-5TX-1SC-2SCS	1345240000	B.14
IE-SW-VL08MT-5TX-3SC	1240970000	B.14
IE-SW-VL08MT-6TX-2SC	1344770000	B.14
IE-SW-VL08MT-6TX-2SCS	1241020000	B.14
IE-SW-VL08MT-6TX-2ST	1240990000	B.14
IE-SW-VL08MT-8TX	1240940000	B.14
IE-SW-VL08T-6GT-2GS	1286870000	B.6
IE-SW-VL08T-8GT	1286860000	B.6
IE-SW-VL09T-6TX-3SC	1240980000	B.4
IE-SW-VL16-14TX-2SC	1241030000	B.4
IE-SW-VL16-14TX-2ST	1241050000	B.4
IE-SW-VL16-16TX	1241000000	B.4
IE-SW-VL16T-14TX-2SC	1286610000	B.4
IE-SW-VL16T-14TX-2ST	1286620000	B.4
IE-SW-VL16T-16TX	1286590000	B.4
IE-TO-LCD-MM	8947010000	H.20
IE-TO-LCD-SM	8947020000	H.20
IE-TO-RJ45-C	8946920000	H.17
IE-TO-RJ45-FJA	8946930000	H.15
IE-TO-RJ45-FJB	8946940000	H.15
IE-TO-RJ45-FJP	8946950000	H.15
IE-TO-SCD-MM	8946970000	H.19
IE-TO-SCD-SM	8946980000	H.19
IE-TO-SCRJ-MM	8946990000	H.19
IE-TO-SCRJ-SM	8947000000	H.19
IE-TO-USB	8946960000	H.18
IE-TO-USB-AB	1438180000	H.18
IE-USB-A-A-0.5M	1993550005	L.45
IE-USB-A-A-1.0M	1993550010	L.45
IE-USB-A-A-1.5M	1993550015	L.45
IE-USB-A-A-1.8M	1993550018	L.45
IE-USB-A-A-3.0M	1993550030	L.45
IE-USB-A-MICRO-1.8M	1487980000	L.45
IE-WALLMOUNT-KIT-30MM	1504450000	F.10
IE-WALLMOUNT-KIT-46MM	1504440000	F.11
IE-XM-6D-RJ45/RJ45-IP67	8829440000	J.33
IE-XM-6U-RJ45/RJ45-IP67	8829440000	J.33
IE-XM-RJ45/IDC	8808360000	H.16
IE-XM-RJ45/IDC-IP67	8808440000	J.33
IE-XM-RJ45/RJ45	8879050000	H.17
IE-XM-RJ45/RJ45-IP67	8808450000	J.33
IE-XM-ST/ST	8808340000	H.20
IE-XR-J45/IDC	8808330000	J.33
IE-XR-RJ45/RJ45-2	8952950000	J.33

K

KOF SET ESD	9205210000	N.9
KOHS 19	9205010000	N.17
KOHS 9.5+19	9205000000	N.17
KOPD 10.0	9205020000	N.17
KT 8	9002650000	N.8

L

LAN USB TESTER	9205400000	N.7
----------------	------------	-----

M

M-D-STRIPAX LWL	9003750000	N.15
MEHA KP LWL M-D-SPX	9003760000	N.15
M-PRINT PRO	1905490000	N.23
multi-stripax IE-POF	1208880000	N.10

P

PJ ADV TNAW	1338710000	N.23
PJ ADV TINTK INK C	1338680000	N.23
PJ ADV TINTK INK K	1338690000	N.23
PJ ADV TINTK INK M	1338670000	N.23
PJ ADV TINTK INK SET	1338720000	N.23
PJ ADV TINTK INK Y	1338650000	N.23
PJ PRO TINTENSET FARBE	1027110000	N.23
PJ PRO TNAW	1024140000	N.23
PJ PRO TINTK INK C	1027050000	N.23
PJ PRO TINTK INK K	1027040000	N.23
PJ PRO TINTK INK M	1027060000	N.23
PJ PRO TINTK INK Y	1027070000	N.23

Type	Order No.	Page
PRINTJET ADVANCED 115V	1338700000	N.23
PRINTJET ADVANCED 230V	1324380000	N.23
PUNCH DOWN TOOL PDT	9013970000	N.16
PWZ RJ45	1118040000	N.6

R

REMOVAL TOOL HD	1866730000	H.7
RM-KIT	1241440000	F.10

S

SAIBM-4/8S-M12 4P D-ZF	1892130001	J.36
SAIBM-4/8S-M12-4P D-COD	1892130000	J.37
SAIBW-4/8S-M12 4P D-ZF	1139330000	J.36
SAI-SK-M12 BU	8425960000	N.21
SAI-SK-M12-UNI	2330260000	N.21
SAISM-4/8S-M12 4P D-ZF	1892120001	J.36
SAISM-4/8S-M12-4P D-COD	1892120000	J.37
SAISW-4/8S-M12 4P D-ZF	1803930001	J.36
SCISSORS KEVLAR	1208910000	N.11
Screwty- M12	1900000000	L.30
Screwty- M12	1900000000	L.31
Screwty- M12	1900000000	L.34
Screwty- M12	1900000000	L.35
Screwty- M12 F	1900020000	J.42
Screwty Set	1910000000	J.42
Screwty Set	1910000000	L.30
Screwty Set	1910000000	L.30
Screwty Set	1910000000	L.31
Screwty Set	1910000000	L.34
Screwty Set	1910000000	L.35
Screwty Set-DM	1920000000	J.42
Screwty Set-DM	1920000000	L.30
Screwty Set-DM	1920000000	L.31
Screwty Set-DM	1920000000	L.34
Screwty Set-DM	1920000000	L.35
Screwty-M12 F-DM	1900021000	J.42
Screwty-M12-DM	1900001000	L.30
Screwty-M12-DM	1900001000	L.31
Screwty-M12-DM	1900001000	L.34
Screwty-M12-DM	1900001000	L.35
SEE ESD 120	9205130000	N.9
SEE ESD 125	9204750000	N.9
SM 27/18 K MC NE GR	1073340000	I.2
SM 27/18 K MC NE SI	1713760000	I.2
SM 27/18 K MC NE WS	1707270000	I.2
SM 27/18 MC NE WS	1699860000	I.24
SM 27/18 MC NE WS	1699860000	I.25
SM 27/18 MC NE WS	1699860000	I.26
SM-H 27/18 SW	1716630000	I.24
SM-H 27/18 SW	1716630000	I.25
SM-H 27/18 SW	1716630000	I.26
SUPER CUT	9205150000	N.9
SVSE ESD 130	9205140000	N.9
SZE ESD 130	9204770000	N.9

T

TM 4/12 HF/HB	1719840000	N.24
TM 4/18 HF/HB	1719850000	N.24
TM-I 18 MC NE GE	1718431687	N.24
TM-I 18 MC NE WS	1718431044	N.24
TOOL SET IE-POF	1208930000	N.10
TT 8 RS MP 8	9202800000	N.5

V

VDATA CAT6	1348590000	N.25
VFSKHV/1,5-2.5/485	1491920000	I.16
VFSKHV/1,5-2.5/638	1491940000	I.19
VT SF 5/21 MC NE WS VO	1689470001	N.24
VT SF 6/21 MC NE WS VO	1730560001	N.24

W

WFSKHV/1,5-2,5	1491970000	I.19
----------------	------------	------

Order No.	Type	Page
1010000000		
1010840015	IE-C5DB4RE0015MCSXXX-X	L40
1010840030	IE-C5DB4RE0030MCSXXX-X	L40
1010840050	IE-C5DB4RE0050MCSXXX-X	L40
1010840100	IE-C5DB4RE0100MCSXXX-X	L40
1010850015	IE-C5DB4RE0015MCSMCS-E	L39
1010850030	IE-C5DB4RE0030MCSMCS-E	L39
1010850050	IE-C5DB4RE0050MCSMCS-E	L39
1010850100	IE-C5DB4RE0100MCSMCS-E	L39
1011540000	IE-BHSV14M-RJA	J5
1011560000	IE-PHV14M-RJ	J2
1011560000	IE-PHV14M-RJ	J6
1012160000	IE-PSV14M-RJ45-TH	G.8
1012170000	IE-PSV14M-RJ45-FHP	J.2
1012310000	IE-BSSV14M-RJ45-C	J.4
1012320000	IE-BSSV14M-RJ45-FJA	J.3
1012370000	IE-BSV01P-RJ45-C	J.19
1012380000	IE-BSV01P-RJ45-FJA	J.19
1012440000	IE-PHV01P	J.18
1012460000	IE-PHV01P-BP	J.18
1012470000	IE-PSV01P-RJ45-TH	J.18
1012490000	IE-PSV01P-RJ45-FH	J.18
1012560000	IE-PSV01P-RJ45-TH-BP	J.18
1012570000	IE-PSV01P-RJ45-FH-BP	J.18
1016960000	IE-BHV01P	J.19
1018790000	IE-FCM-RJ45-C	L25
1018810000	IE-FCM-RJ45-FJA	L24
1018820000	IE-FCM-RJ45-FJB	L24
1018830000	IE-FCM-RJ45-FJP	L24
1018840000	IE-FCM-USB-A	L26
1019570000	IE-BI-USB-A	J.52

1020000000

1024140000	PJ PRO TNAW	N.23
1025940015	IE-C5DD4UG0015MCSXXX-X	L31
1025940030	IE-C5DD4UG0030MCSXXX-X	L31
1025940050	IE-C5DD4UG0050MCSXXX-X	L31
1025940100	IE-C5DD4UG0100MCSXXX-X	L31
1025950005	IE-C5DD4UG0005MCSMCS-E	L30
1025950015	IE-C5DD4UG0015MCSMCS-E	L30
1025950030	IE-C5DD4UG0030MCSMCS-E	L30
1025950050	IE-C5DD4UG0050MCSMCS-E	L30
1025950100	IE-C5DD4UG0100MCSMCS-E	L30
1027040000	PJ PRO TINTK INK K	N.23
1027050000	PJ PRO TINTK INK C	N.23
1027060000	PJ PRO TINTK INK M	N.23
1027070000	PJ PRO TINTK INK Y	N.23
1027110000	PJ PRO TINTENSET FARBE	N.23

1030000000

1032030000	IE-CTC-SCST-GOF	N.12
1033350000	IE-CTC-ASLC-GOF	N.12

1040000000

1044470010	IE-C5DD4UG0010MCSA20-E	L31
1044470015	IE-C5DD4UG0015MCSA20-E	L31
1044470030	IE-C5DD4UG0030MCSA20-E	L31
1044470050	IE-C5DD4UG0050MCSA20-E	L31
1044470100	IE-C5DD4UG0100MCSA20-E	L31
1045780000	IE-OP-V04P-1S	K.13
1045960000	IE-CC-V04P	J.24
1047940000	IE-BHDV14M	J.6
1047950000	IE-BHCV14M-RJA	J.6

1050000000

1058100000	IE-PHV14M-FD	J.10
1058120000	IE-BSSV14M-SCRJ-MM-C	J.11
1058130000	IE-BSSV14M-LCD-MM-C	J.11
1058140000	IE-BSSV14M-SCRJ-SM-C	J.11
1058150000	IE-BSSV14M-LCD-SM-C	J.11
1058250000	IE-BSCV14M-RJ45-C	J.4
1058270000	IE-BSCV14M-RJ45-FJA	J.3
1058280000	IE-PPV14P	N.21
1058310000	IE-BPV14P	N.21
1059330015	IE-C5DD4UG0015MSSMCS-E	L30
1059330030	IE-C5DD4UG0030MSSMCS-E	L30
1059330050	IE-C5DD4UG0050MSSMCS-E	L30
1059330100	IE-C5DD4UG0100MSSMCS-E	L30
1059340015	IE-C5DB4RE0015MSSMCS-E	L39
1059340030	IE-C5DB4RE0030MSSMCS-E	L39
1059340050	IE-C5DB4RE0050MSSMCS-E	L39
1059340100	IE-C5DB4RE0100MSSMCS-E	L39
1059750015	IE-C5DD4UG0015MCAXXX-X	L33
1059750030	IE-C5DD4UG0030MCAXXX-X	L33
1059750050	IE-C5DD4UG0050MCAXXX-X	L33
1059750100	IE-C5DD4UG0100MCAXXX-X	L33
1059770015	IE-C5DD4UG0015MCSMCA-E	L32
1059770030	IE-C5DD4UG0030MCSMCA-E	L32
1059770050	IE-C5DD4UG0050MCSMCA-E	L32
1059770100	IE-C5DD4UG0100MCSMCA-E	L32
1059890015	IE-C5DD4UG0015MCAECA-E	L32
1059890030	IE-C5DD4UG0030MCAECA-E	L32
1059890050	IE-C5DD4UG0050MCAECA-E	L32
1059890100	IE-C5DD4UG0100MCAECA-E	L32

Order No.	Type	Page
1059900015	IE-C5DB4RE0015MCAXXX-X	L42
1059900030	IE-C5DB4RE0030MCAXXX-X	L42
1059900050	IE-C5DB4RE0050MCAXXX-X	L42
1059900100	IE-C5DB4RE0100MCAXXX-X	L42
1059940015	IE-C5DB4RE0015MCSMCA-E	L41
1059940030	IE-C5DB4RE0030MCSMCA-E	L41
1059940050	IE-C5DB4RE0050MCSMCA-E	L41
1059940100	IE-C5DB4RE0100MCSMCA-E	L41
1059970015	IE-C5DB4RE0015MCAECA-E	L41
1059970030	IE-C5DB4RE0030MCAECA-E	L41
1059970050	IE-C5DB4RE0050MCAECA-E	L41
1059970100	IE-C5DB4RE0100MCAECA-E	L41

1060000000

1061820000	IE-CC-V01P	J.20
1061830000	IE-OP-V01P-1S	K.11
1062550000	IE-FM5Z2V00005MLDLDLX	M.11
1062570000	IE-FM5Z2V0002MLDLDLX	M.11
1062580000	IE-FM5Z2V0010MLDLDLX	M.11
1062590000	IE-BSCV14M-SCRJ-MM-C	J.11
1062600000	IE-BSCV14M-SCRJ-SM-C	J.11
1062610000	IE-BSCV14M-LCD-MM-C	J.11
1062620000	IE-BSCV14M-LCD-SM-C	J.11
1063320000	IE-C5ES8UG0100A45A40-X	G.8
1066850000	IE-C5ES8UG0010B41B41-E	L38
1066860000	IE-C5ES8UG0020B41B41-E	L38
1066870000	IE-C5ES8UG0050B41B41-E	L38
1066880000	IE-C5ES8UG0100B41B41-E	L38
1067380000	IE-PI-SCRJ-MM	J.53
1067390000	IE-PI-SCRJ-SM	J.53
1067410000	IE-PI-SCRJ-POF	J.53
1068820000	IE-CDV14MRJ/VAPM24V-CMA	K.4
1068830000	IE-CDV14MRJ/VAPM24V-FJ	K.2
1068840000	IE-CDV14MHYB-10P-CMA	K.8
1068850000	IE-CDV14MHYB-10P-FJ	K.7
1068870000	IE-CDV14MRJ-CMA	K.4
1068880000	IE-CDV14MRJ-FJ	K.2
1068910000	IE-PS-VAPM-24V	J.58
1068920000	IE-BHD-VAPM	J.59
1068930000	IE-BPV-VAPM	N.21
1068950000	IE-PIC-HYB-S-0,75-300	J.50
1068970000	IE-BIC-HYB-P-0,75-300	J.51
1068990000	IE-PHYB-10P	J.50
1069010000	IE-BH-HYB-10P	J.51
1069030000	IE-BSS-VAPM-24V	J.59

1070000000

1072900000	IE-BSSV14M-HYB-10P-FJ	J.7
1072910000	IE-PSV14M-HYB-10P	J.6
1073340000	SM 27/18 K MC NE GR	L.2
1077300000	IE-PS-V05M-A-RJ45-FH	J.30

1080000000

1085260000	IE-BSSV14M-RJ45-FJP	J.3
------------	---------------------	-----

1090000000

1096150000	IE-BIC-HYB-P-0,5-300	J.51
1096180000	IE-PIC-HYB-S-0,5-300	J.50
1099580000	IE-CD-MA	K.2
1099580000	IE-CD-MA	K.7

1100000000

1103010000	IE-C5IT4UG-MW	L.15
1106010000	IE-C5ES8UG0010P41P41-E	L38
1106020000	IE-C5ES8UG0020P41P41-E	L38
1106030000	IE-C5ES8UG0050P41P41-E	L38
1106040000	IE-C5ES8UG0100P41P41-E	L38

1110000000

1118040000	PWZ RJ45	N.6
1119580000	HTF HYB	N.14
1119730010	IE-C5DD4UG0010A2EA2E-X	L27
1119730020	IE-C5DD4UG0020A2EA2E-X	L27
1119730030	IE-C5DD4UG0030A2EA2E-X	L27
1119730050	IE-C5DD4UG0050A2EA2E-X	L27
1119730100	IE-C5DD4UG0100A2EA2E-X	L27
1119730150	IE-C5DD4UG0150A2EA2E-X	L27
1119730200	IE-C5DD4UG0200A2EA2E-X	L27

1120000000

1122710000	IE-CD-V04PRJ-CMA	K.13
------------	------------------	------

1130000000

1131380000	IE-BI-USB-AB	J.52
1132010000	IE-PR-RJ45-FH-A	J.46
1132020000	IE-PR-RJ45-FH-B	J.46
1132030000	IE-PR-RJ45-FH-P	J.46
1132040000	IE-PS-RJ45-FH-BK-A	H.2
1132050000	IE-PS-RJ45-FH-BK-B	H.2
1132060000	IE-PS-RJ45-FH-BK-P	H.2
1135150000	IE-PIC-HYB-S-0,2-300	J.50

Order No.	Type	Page
1135160000	IE-BIC-HYB-P-0,2-300	J.51
1135240000	IE-KOK-V14	N.17
1139330000	SAIBW 4/8S-M12 4P DZF	J.36

1160000000

1165900002	IE-C6FP8LB0002M40M40-B	L18
1165900005	IE-C6FP8LB0005M40M40-B	L18
1165900010	IE-C6FP8LB0010M40M40-B	L18
1165900015	IE-C6FP8LB0015M40M40-B	L18
1165900020	IE-C6FP8LB0020M40M40-B	L18
1165900030	IE-C6FP8LB0030M40M40-B	L18
1165900050	IE-C6FP8LB0050M40M40-B	L18
1165900100	IE-C6FP8LB0100M40M40-B	L18
1165900150	IE-C6FP8LB0150M40M40-B	L18
1165900200	IE-C6FP8LB0200M40M40-B	L18
1165900250	IE-C6FP8LB0250M40M40-B	L18
1165940002	IE-C6FP8LD0002M40M40-D	L17
1165940005	IE-C6FP8LD0005M40M40-D	L17
1165940010	IE-C6FP8LD0010M40M40-D	L17
1165940015	IE-C6FP8LD0015M40M40-D	L17
1165940020	IE-C6FP8LD0020M40M40-D	L17
1165940030	IE-C6FP8LD0030M40M40-D	L17
1165940050	IE-C6FP8LD0050M40M40-D	L17
1165940075	IE-C6FP8LD0075M40M40-D	L17
1165940100	IE-C6FP8LD0100M40M40-D	L17
1165940150	IE-C6FP8LD0150M40M40-D	L17
1165940200	IE-C6FP8LD0200M40M40-D	L17
1165940250	IE-C6FP8LD0250M40M40-D	L17
1166000005	IE-C5ES8UG0005M40M40-G	L23
1166000010	IE-C5ES8UG0010M40M40-G	L23
1166000015	IE-C5ES8UG0015M40M40-G	L23
1166000020	IE-C5ES8UG0020M40M40-G	L23
1166000030	IE-C5ES8UG0030M40M40-G	L23
1166000050	IE-C5ES8UG0050M40M40-G	L23
1166000100	IE-C5ES8UG0100M40M40-G	L23
1166000150	IE-C5ES8UG0150M40M40-G	L23
1166000200	IE-C5ES8UG0200M40M40-G	L23
1166020005	IE-C5ES8VG0005M40M40-G	L23
1166020010	IE-C5ES8VG0010M40M40-G	L23
1166020015	IE-C5ES8VG0015M40M40-G	L23
1166020020	IE-C5ES8VG0020M40M40-G	L23
1166020030	IE-C5ES8VG0030M40M40-G	L23
1166020050	IE-C5ES8VG0050M40M40-G	L23
1166020100	IE-C5ES8VG0100M40M40-G	L23
1166020150	IE-C5ES8VG0150M40M40-G	L23
1166020200	IE-C5ES8VG0200M40M40-G	L23
1166030002	IE-C6FP8LR0002M40M40-R	L19
1166030005	IE-C6FP8LR0005M40M40-R	L19
1166030010	IE-C6FP8LR0010M40M40-R	L19
1166030015	IE-C6FP8LR0015M40M40-R	L19
1166030020	IE-C6FP8LR0020M40M40-R	L19
1166030030	IE-C6FP8LR0030M40M40-R	L19
1166030050	IE-C6FP8LR0050M40M40-R	L19
1166030100	IE-C6FP8LR0100M40M40-R	L19
1166030150	IE-C6FP8	

Order No.	Type	Page
-----------	------	------

121000000

1212770000	AIE MULTI-STRIPAX POF	N.10
------------	-----------------------	------

122000000

1220310040	IE-C5DB4WE0040MCSA20-E	L.43
1220930000	IE-FM6D2UE0005MLD0LDX	M.13
1221010000	IE-BS-V01M-SCRJ-MM	J.15
1221020000	IE-BS-V01M-SCRJ-SM	J.15
1221030000	IE-BHD-V01M-SCA	J.15
1222550000	IE-FCM-USB-AB	I.26

123000000

1233160005	IE-C6FP8LD0005M40W40-D	L.21
1233160010	IE-C6FP8LD0010M40W40-D	L.21
1233160012	IE-C6FP8LD0012M40W40-D	L.21
1233160015	IE-C6FP8LD0015M40W40-D	L.21
1233160020	IE-C6FP8LD0020M40W40-D	L.21
1233160030	IE-C6FP8LD0030M40W40-D	L.21
1233160050	IE-C6FP8LD0050M40W40-D	L.21
1233160100	IE-C6FP8LD0100M40W40-D	L.21
1234750005	IE-C5DS4UG0005MBSA20-E	L.34
1234750010	IE-C5DS4UG0010MBSA20-E	L.34
1234750015	IE-C5DS4UG0015MBSA20-E	L.34
1234750020	IE-C5DS4UG0020MBSA20-E	L.34
1234750050	IE-C5DS4UG0050MBSA20-E	L.34
1234770005	IE-C5DS4UG0005MBSXXX-E	L.35
1234770010	IE-C5DS4UG0010MBSXXX-E	L.35
1234770015	IE-C5DS4UG0015MBSXXX-E	L.35
1234770020	IE-C5DS4UG0020MBSXXX-E	L.35
1234770050	IE-C5DS4UG0050MBSXXX-E	L.35

124000000

1240940000	IE-SW-VL08MT-8TX	B.14
1240970000	IE-SW-VL08MT-5TX-3SC	B.14
1240980000	IE-SW-VL09T-6TX-3SC	B.4
1240990000	IE-SW-VL08MT-6TX-2ST	B.14
1241000000	IE-SW-VL16-16TX	B.4
1241020000	IE-SW-VL08MT-6TX-2SCS	B.14
1241030000	IE-SW-VL16-14TX-2SC	B.4
1241040000	IE-SW-PL08M-8TX	B.15
1241050000	IE-SW-VL16-14TX-2ST	B.4
1241070000	IE-SW-PL08M-6TX-2SC	B.15
1241080000	IE-SW-PL08M-6TX-2ST	B.15
1241090000	IE-SW-PL08M-6TX-2SCS	B.15
1241100000	IE-SW-PL16M-16TX	B.15
1241120000	IE-SW-PL16M-14TX-2SC	B.15
1241130000	IE-SW-PL16M-14TX-2ST	B.15
1241250000	IE-SW-BL05-5GT	B.6
1241270000	IE-SW-VL08-8GT	B.6
1241280000	IE-SW-VL08-6GT-2GS	B.6
1241290000	IE-SW-PL10M-3GT-7TX	B.16
1241300000	IE-SW-PL10M-1GT-2GS-7TX	B.16
1241320000	IE-SW-PL18M-2GT-16TX	B.17
1241330000	IE-SW-PL18M-2GC14TX2SC	B.17
1241340000	IE-SW-PL18M-2GC14TX2ST	B.17
1241350000	IE-SW-PL18M-2GC14TX2SCS	B.17
1241370000	IE-SW-PL09M-5GC-4GT	B.18
1241380000	IE-SW-BL06-2TX-4POE	B.21
1241390000	IE-SW-PL06M-2TX-4POE	B.23
1241400000	IE-MC-VL1TX-1SC	D.3
1241410000	IE-MC-VL1TX-1ST	D.3
1241420000	IE-MC-VL1TX-1SCS	D.3
1241430000	EBR-MODULE RS232	F.9
1241440000	RM-KIT	F.10
1241450000	IE-SFP-1FEMLC-T	F.8
1241470000	IE-SFP-1FESLC-T	F.8
1241480000	IE-SFP-1FELLC-T	F.8
1241490000	IE-SFP-1GSLXC	F.8
1241500000	IE-SFP-1GLSXL	F.8
1241510000	IE-SFP-1GLXLC	F.8
1241520000	IE-SFP-1GLHXL	F.8
1242080000	IE-CS-2TX-1RS232/485	D.5
1242090000	IE-CS-2TX-2RS232/485	D.5
1242820000	IE-FP022E-MW	M.6
1244130005	IE-C5DS4UG0005MBSMCS-E	L.34
1244130010	IE-C5DS4UG0010MBSMCS-E	L.34
1244130015	IE-C5DS4UG0015MBSMCS-E	L.34
1244130020	IE-C5DS4UG0020MBSMCS-E	L.34
1244130050	IE-C5DS4UG0050MBSMCS-E	L.34
1248280005	IE-C6FP8LD0005M40V40-D	L.21
1248280010	IE-C6FP8LD0010M40V40-D	L.21
1248280012	IE-C6FP8LD0012M40V40-D	L.21
1248280015	IE-C6FP8LD0015M40V40-D	L.21
1248280020	IE-C6FP8LD0020M40V40-D	L.21
1248280030	IE-C6FP8LD0030M40V40-D	L.21
1248280050	IE-C6FP8LD0050M40V40-D	L.21
1248280100	IE-C6FP8LD0100M40V40-D	L.21

125000000

1251580002	IE-C6FP8LY0002M40M40-Y	L.20
1251580005	IE-C6FP8LY0005M40M40-Y	L.20
1251580010	IE-C6FP8LY0010M40M40-Y	L.20
1251580015	IE-C6FP8LY0015M40M40-Y	L.20
1251580020	IE-C6FP8LY0020M40M40-Y	L.20

Order No.	Type	Page
-----------	------	------

1251580030	IE-C6FP8LY0030M40M40-Y	L.20
1251580050	IE-C6FP8LY0050M40M40-Y	L.20
1251580100	IE-C6FP8LY0100M40M40-Y	L.20
1251580150	IE-C6FP8LY0150M40M40-Y	L.20
1251580200	IE-C6FP8LY0200M40M40-Y	L.20
1251580250	IE-C6FP8LY0250M40M40-Y	L.20
1251590002	IE-C6FP8LG0002M40M40-G	L.19
1251590005	IE-C6FP8LG0005M40M40-G	L.19
1251590010	IE-C6FP8LG0010M40M40-G	L.19
1251590015	IE-C6FP8LG0015M40M40-G	L.19
1251590020	IE-C6FP8LG0020M40M40-G	L.19
1251590030	IE-C6FP8LG0030M40M40-G	L.19
1251590050	IE-C6FP8LG0050M40M40-G	L.19
1251590100	IE-C6FP8LG0100M40M40-G	L.19
1251590150	IE-C6FP8LG0150M40M40-G	L.19
1251590200	IE-C6FP8LG0200M40M40-G	L.19
1251590250	IE-C6FP8LG0250M40M40-G	L.19
1251610002	IE-C6FP8LE0002M40M40-E	L.18
1251610005	IE-C6FP8LE0005M40M40-E	L.18
1251610010	IE-C6FP8LE0010M40M40-E	L.18
1251610015	IE-C6FP8LE0015M40M40-E	L.18
1251610020	IE-C6FP8LE0020M40M40-E	L.18
1251610030	IE-C6FP8LE0030M40M40-E	L.18
1251610050	IE-C6FP8LE0050M40M40-E	L.18
1251610100	IE-C6FP8LE0100M40M40-E	L.18
1251610150	IE-C6FP8LE0150M40M40-E	L.18
1251610200	IE-C6FP8LE0200M40M40-E	L.18
1251610250	IE-C6FP8LE0250M40M40-E	L.18
1253240000	IE-CDR-V14M-SCPOF/VAPM-C	K.9

126000000

1269740050	IE-C5DB4WE0050MCSXXX-E	L.43
1269740100	IE-C5DB4WE0100MCSXXX-E	L.43

127000000

1271240000	IE-PS-V04P-RJ45-FH-B	J.22
1271250000	IE-PS-V05M-RJ45-FH-B	J.30
1273090000	IE-C7FS8LD-305M	L.10
1273430010	IE-FP022E0001MSJOSJ0-X	M.12
1273430030	IE-FP022E0003MSJOSJ0-X	M.12
1273430050	IE-FP022E0005MSJOSJ0-X	M.12
1273430100	IE-FP022E0010MSJOSJ0-X	M.12
1273430200	IE-FP022E0020MSJOSJ0-X	M.12
1276880000	IE-FM62V00001MLD0LDX	M.11
1278420000	IE-SCRJ-IP20-POF-100	H.7
1278430000	IE-SCRJ-IP67-POF-100	J.53

128000000

1285830000	IE-CST-2TX-1RS232/485	D.5
1285840000	IE-CST-2TX-2RS232/485	D.5
1286590000	IE-SW-VL16T-16TX	B.4
1286610000	IE-SW-VL16T-14TX-2SC	B.4
1286620000	IE-SW-VL16T-14TX-2ST	B.4
1286700000	IE-SFP-1GSLXC-T	F.8
1286710000	IE-SFP-1GLSXL-T	F.8
1286720000	IE-SFP-1GLXLC-T	F.8
1286730000	IE-SFP-1GLHXL-T	F.8
1286780000	IE-SW-PL08MT-8TX	B.15
1286790000	IE-SW-PL08MT-6TX-2SC	B.15
1286800000	IE-SW-PL08MT-6TX-2ST	B.15
1286810000	IE-SW-PL08MT-6TX-2SCS	B.15
1286820000	IE-SW-PL16MT-16TX	B.15
1286830000	IE-SW-PL16MT-14TX-2SC	B.15
1286840000	IE-SW-PL16MT-14TX-2ST	B.15
1286850000	IE-SW-BL05T-5GT	B.6
1286860000	IE-SW-VL08T-8GT	B.6
1286870000	IE-SW-VL08T-6GT-2GS	B.6
1286880000	IE-MC-VLT-1TX-1SC	D.3
1286890000	IE-MC-VLT-1TX-1ST	D.3
1286900000	IE-MC-VLT-1TX-1SCS	D.3
1286910000	IE-SW-PL06MT-2TX-4PDE	B.23
1286920000	IE-SW-BL06T-2TX-4PDE	B.21
1286930000	IE-SW-PL10MT-3GT-7TX	B.16
1286940000	IE-SW-PL10MT-1GT-2GS-7TX	B.16
1286970000	IE-SW-PL18MT-2GT-16TX	B.17
1286990000	IE-SW-PL18MT-2GC14TX2SC	B.17
1287000000	IE-SW-PL18MT-2GC14TX2ST	B.17
1287010000	IE-SW-PL18MT-2GC14TX2SCS	B.17
1287020000	IE-SW-PL09MT-5GC-4GT	B.18
1287910000	IE-C7FS8LR-305M	L.11

129000000

1296450000	IE-FM622V00001MLD0LDX	M.11
1296710000	IE-BHS-V14M-RJA-45	J.8
1297010000	IE-CD-VAPM24V-Y-MA	K.6

130000000

1302000000	IE-AD-BHS-V14M-RJA	J.8
1307610010	IE-C5DD4UG0010B2EB2E-X	L.28
1307610020	IE-C5DD4UG0020B2EB2E-X	L.28
1307610030	IE-C5DD4UG0030B2EB2E-X	L.28
1307610050	IE-C5DD4UG0050B2EB2E-X	L.28
1307610100	IE-C5DD4UG0100B2EB2E-X	L.28

131000000

1312160003	IE-C6FP8LD0003X40X40-Y	L.22
1312160004	IE-C6FP8LD0004X40X40-Y	L.22
1312160005	IE-C6FP8LD0005X40X40-Y	L.22
1312160010	IE-C6FP8LD0010X40X40-Y	L.22
1312160020	IE-C6FP8LD0020X40X40-Y	L.22
1312160030	IE-C6FP8LD0030X40X40-Y	L.22
1312160050	IE-C6FP8LD0050X40X40-Y	L.22
1312160100	IE-C6FP8LD0100X40X40-Y	L.22
1312160150	IE-C6FP8LD0150X40X40-Y	L.22
1312160200	IE-C6FP8LD0200X40X40-Y	L.22
1312690010	IE-C5I14UG0010B2EB2E-X	L.28
1312690020	IE-C5I14UG0020B2EB2E-X	L.28
1312690030	IE-C5I14UG0030B2EB2E-X	L.28
1312690050	IE-C5I14UG0050B2EB2E-X	L.28
1312690100	IE-C5I14UG0100B2EB2E-X	L.28
1318011000	IE-FM6C2UE0100MSD1SD1X	M.15
1318011800	IE-FM6C2UE0180MSD1SD1X	M.15
1318012000	IE-FM6C2UE0200MSD1SD1X	M.15
1318012500	IE-FM6C2UE0250MSD1SD1X	M.15
1318013000	IE-FM6C2UE0300MSD1SD1X	M.15
1318013500	IE-FM6C2UE0350MSD1SD1X	M.15
1318015000	IE-FM6C2UE0500MSD1SD1X	M.15
1318150000	IE-CD-V14M-SCRJ-MM-C-MA	K.5

132000000

1323940000	IE-PS-VAPM-400V	J.58
1323950000	IE-BSS-VAPM-400V	J.59
1324010000	IE-PCB-M12X-S-180	J.44
1324020000	IE-PS-M12X-P-FH	J.41
1324380000	PRINTJET ADVANCED 230V	N.23
1324440000	IE-CDM-V14MRJSCP/VAPM-C	K.9
1326540000	IE-C7FS8LB-305M	L.10

133000000

1333160000	IE-C7FS8LM-305M	L.12
1338650000	PJ ADV TINTK INK Y	N.23
1338670000	PJ ADV TINTK INK M	N.23
1338680000	PJ ADV TINTK INK C	N.23
1338690000	PJ ADV TINTK INK K	N.23
1338700000	PRINTJET ADVANCED 115V	N.23
1338710000	PJ ADV TNAW	N.23
1338720000	PJ ADV TINTK INK SET	N.23

134000000

1344670000	IE-C7FS8LY-305M	L.12
1344680000	IE-C7FS8LG-305M	L.11
1344690000	IE-C7FS8LE-305M	L.11
1344760000		

Order No.	Type	Page
1398070050	IE-C6KS8V60050XCSCXS-E	L.36
1398070100	IE-C6KS8V60100XCSCXS-E	L.36
1398770000	IE-FP02DUG-MW	M.6

1400000000

1400610000	IE-AD-M12XRJ45-90	J.43
1400620000	IE-AD-M12XRJ45-180	J.43
1403680050	IE-CSP05US0050VAPVAP-X	L.29
1403680100	IE-CSP05US0100VAPVAP-X	L.29
1403680150	IE-CSP05US0150VAPVAP-X	L.29

1420000000

1421710010	IE-C5DB4WE0010A20A20-E	L.44
1421710020	IE-C5DB4WE0020A20A20-E	L.44
1421710030	IE-C5DB4WE0030A20A20-E	L.44
1421710050	IE-C5DB4WE0050A20A20-E	L.44
1421710100	IE-C5DB4WE0100A20A20-E	L.44
1421710200	IE-C5DB4WE0200A20A20-E	L.44
1427670000	IE-PCBR-M12X-S-180	J.44
1427960000	IE-FCM-USB-3.0-A	L.26

1430000000

1433800000	IE-PCB-RJ45-THR-C5-A	H.10
1433810000	IE-PCB-RJ45-THR-C5-S	H.11
1433890000	IE-PCB-RJ45-SMD-C5-A	H.12
1433900000	IE-PCB-RJ45-SMD-C5-S	H.13
1433910000	IE-PCB-RJ45-THR-C6-AI	H.14
1433920000	IE-PCB-RJ45-THR-C6-S	H.14
1433930005	IE-FM6Z2L00005DL0LD0-X	M.8
1433930010	IE-FM6Z2L00001MLD0LD0-X	M.8
1433930020	IE-FM6Z2L00002MLD0LD0-X	M.8
1433930030	IE-FM6Z2L00003MLD0LD0-X	M.8
1433930050	IE-FM6Z2L00005MLD0LD0-X	M.8
1433930100	IE-FM6Z2L00010MLD0LD0-X	M.8
1433940005	IE-FM5Z2L00005LD0LD0-X	M.8
1433940010	IE-FM5Z2L00001MLD0LD0-X	M.8
1433940020	IE-FM5Z2L00002MLD0LD0-X	M.8
1433940030	IE-FM5Z2L00003MLD0LD0-X	M.8
1433940050	IE-FM5Z2L00005MLD0LD0-X	M.8
1433940100	IE-FM5Z2L00010MLD0LD0-X	M.8
1433950005	IE-FSMZ2LY0005DL0LD0-X	M.9
1433950010	IE-FSMZ2LY0001MLD0LD0-X	M.9
1433950020	IE-FSMZ2LY0002MLD0LD0-X	M.9
1433950030	IE-FSMZ2LY0003MLD0LD0-X	M.9
1433950050	IE-FSMZ2LY0005MLD0LD0-X	M.9
1433950100	IE-FSMZ2LY0010MLD0LD0-X	M.9
1433960005	IE-FM6Z2L00005SD0SD0-X	M.7
1433960010	IE-FM6Z2L00001MSD0SD0-X	M.7
1433960020	IE-FM6Z2L00002MSD0SD0-X	M.7
1433960030	IE-FM6Z2L00003MSD0SD0-X	M.7
1433960050	IE-FM6Z2L00005MSD0SD0-X	M.7
1433960100	IE-FM6Z2L00010MSD0SD0-X	M.7
1433970005	IE-FM5Z2L00005SD0SD0-X	M.7
1433970010	IE-FM5Z2L00001MSD0SD0-X	M.7
1433970020	IE-FM5Z2L00002MSD0SD0-X	M.7
1433970030	IE-FM5Z2L00003MSD0SD0-X	M.7
1433970050	IE-FM5Z2L00005MSD0SD0-X	M.7
1433970100	IE-FM5Z2L00010MSD0SD0-X	M.7
1433980005	IE-FM6Z2L00005DSTOSTO-X	M.7
1433980010	IE-FM6Z2L00001MSTOSTO-X	M.7
1433980020	IE-FM6Z2L00002MSTOSTO-X	M.7
1433980030	IE-FM6Z2L00003MSTOSTO-X	M.7
1433980050	IE-FM6Z2L00005MSTOSTO-X	M.7
1433980100	IE-FM6Z2L00010MSTOSTO-X	M.7
1433990005	IE-FM5Z2L00005DSTOSTO-X	M.7
1433990010	IE-FM5Z2L00001MSTOSTO-X	M.7
1433990020	IE-FM5Z2L00002MSTOSTO-X	M.7
1433990030	IE-FM5Z2L00003MSTOSTO-X	M.7
1433990050	IE-FM5Z2L00005MSTOSTO-X	M.7
1433990100	IE-FM5Z2L00010MSTOSTO-X	M.7
1438180000	IE-TO-USB-AB	H.18

1440000000

1444850000	IE-PCBR2-M12X-S-180	J.44
1449420050	IE-FSMD2UE0005MSDESDEX	M.16
1449420200	IE-FSMD2UE0020MSDESDEX	M.16
1449420250	IE-FSMD2UE0025MSDESDEX	M.16
1449420400	IE-FSMD2UE0040MSDESDEX	M.16
1449470005	IE-C6KS8V60005XCSCXXX-E	L.36
1449470015	IE-C6KS8V60015XCSCXXX-E	L.36
1449470050	IE-C6KS8V60050XCSCXXX-E	L.36
1449470100	IE-C6KS8V60100XCSCXXX-E	L.36

1450000000

1450510000	IE-FC-SFP-KNOB	I.2
1450520000	IE-FC-SFP-KEY	I.2
1450530000	IE-FC-SFM-KNOB	I.2
1450540000	IE-FC-SFM-KEY	I.2
1450550000	IE-FC-SP-PWB/2ST	I.3
1450700000	IE-FC-SP-PWS/4ST	I.7
1450800000	IE-FC-SP-1ST/1D9/1D25	I.4
1450900000	IE-FC-SP-2ST/2D9	I.6
1450600000	IE-FC-SP-PWS/2ST/1D9	I.3
1450610000	IE-FC-SP-PWS/2D9	I.7

Order No.	Type	Page
1450620000	IE-FC-SP-PWU/2ST	I.5
1450630000	IE-FC-IP-PWB/2ST	I.3
1450640000	IE-FC-IP-PWS/4ST	I.7
1450650000	IE-FC-IP-1ST/1D9/1D25	I.4
1450670000	IE-FC-IP-2ST/2D9	I.6
1450680000	IE-FC-IP-PWS/2D9	I.7
1450690000	IE-FC-IP-PWS/2ST/1D9	I.3
1450700000	IE-FC-IP-PWU/2ST	I.5
1450710000	IE-FC-IP-BP	I.4
1450730000	IE-FC-IP-PWB-DE	I.12
1450740000	IE-FC-IP-PWB-EU	I.15
1450750000	IE-FC-IP-PWB-FR	I.13
1450770000	IE-FC-IP-PWB-GB	I.14
1450780000	IE-FC-IP-PWB-CH	I.13
1450790000	IE-FC-IP-PWB-CN	I.16
1450800000	IE-FC-IP-PWS-US	I.16
1450810000	IE-FC-IP-PWS-IT	I.14
1450820000	IE-FC-PWPC	I.20
1450830000	IE-FC-IP-PWB-AU	I.15
1450840000	IE-FC-IP-D9-FM	I.10
1450850000	IE-FC-IP-D9-FM	I.10
1450870000	IE-FC-IP-D9-FS	I.10
1450880000	IE-FC-IP-D25-FF	I.10
1450890000	IE-FC-IP-D25-FM	I.10
1450900000	IE-FC-IP-D25-FS	I.10
1455220000	IE-PCB-RJ45-SMD-C5-AI	H.12
1455240000	IE-PCB-RJ45-THR-C5-AI	H.10
1457580010	IE-C6ES8U60010A40XCS-E	L.37
1457580020	IE-C6ES8U60020A40XCS-E	L.37
1457580030	IE-C6ES8U60030A40XCS-E	L.37
1457580050	IE-C6ES8U60050A40XCS-E	L.37
1457580100	IE-C6ES8U60100A40XCS-E	L.37
1457580120	IE-C6ES8U60120A40XCS-E	L.37

1460000000

1465930000	IE-FC-KEY	I.2
------------	-----------	-----

1480000000

1487920000	IE-BI-USB-3.0-A	J.52
1487980000	IE-USB-A-MICRO-1.8M	L.45
1489940000	IE-SR-2GT-LAN-FN	C.6

1490000000

1491160000	IE-ANT-3G-806-2170-2NF	F.6
1491180000	IE-CC-NM-SMAM-2M	F.7
1491190000	IE-CC-NM-SMAM-4M	F.7
1491210000	IE-CC-NM-SMAM-6M	F.7
1491920000	VFSKHV1.5-2.5/485	I.16
1491940000	VFSKHV1.5-2.5/638	I.19
1491970000	VFSKHV1.5-2.5	I.19
1499940000	IE-CC-9W-FA-IP67	N.3

1500000000

1504210000	IE-SW-BL06-4POE-2SC	B.21
1504220000	IE-SW-BL06T-4POE-2SC	B.21
1504230000	IE-SW-BL06-4POE-2ST	B.21
1504240000	IE-SW-BL06T-4POE-2ST	B.21
1504250000	IE-SW-BL06-1TX-4POE-1SC	B.21
1504260000	IE-SW-BL06T-1TX-4POE-1SC	B.21
1504270000	IE-SW-BL06-1TX-4POE-1ST	B.21
1504280000	IE-SW-VL05M-5TX	B.13
1504290000	IE-SW-BL06T-1TX-4POE-1ST	B.21
1504310000	IE-SW-VL05MT-5TX	B.13
1504320000	IE-SW-BL05-1GT-4GTPOE	B.22
1504330000	IE-SW-VL05M-3TX-2SC	B.13
1504340000	IE-SW-BL05T-1GT-4GTPOE	B.22
1504350000	IE-SW-VL05MT-3TX-2SC	B.13
1504360000	IE-SW-BL05-1GS-4GTPOE	B.22
1504370000	IE-SW-VL05M-3TX-2ST	B.13
1504380000	IE-SW-BL05T-1GS-4GTPOE	B.22
1504390000	IE-SW-VL05MT-3TX-2ST	B.13
1504410000	IE-SW-IP67-5M12	B.5
1504420000	IE-SW-IP67T-5M12	B.5
1504430000	IE-DINRAILMOUNT-KIT	F.11
1504440000	IE-WALLMOUNT-KIT-46MM	F.11
1504450000	IE-WALLMOUNT-KIT-30MM	F.10
1504460000	IE-GW-MB-2TX-1RS232/485	D.8
1504470000	IE-GWT-MB-2TX-1RS232/485	D.8

1510000000

1514940000	IE-AD-M12DRJ45-MF-90	J.38
1514970000	IE-AD-M12DRJ45-MF-180	J.38
1516330000	IE-PS-M12X-S-FH	J.42
1516340000	IE-BS-M12X-S-FH	J.42
1518080000	IE-PS-RJ45-FH-90-A-1.1	H.4
1518090000	IE-PS-RJ45-FH-90-B-1.1	H.4
1518100000	IE-PS-RJ45-FH-90-P-1.6	H.5

1520000000

1522100005	IE-C5DS4V60005A60A60-E	L.26
1522100010	IE-C5DS4V60010A60A60-E	L.26
1522100020	IE-C5DS4V60020A60A60-E	L.26
1522100030	IE-C5DS4V60030A60A60-E	L.26

Order No.	Type	Page
1522100050	IE-C5DS4V60050A60A60-E	L.26
1522100100	IE-C5DS4V60100A60A60-E	L.26
1522100150	IE-C5DS4V60150A60A60-E	L.26
1522100200	IE-C5DS4V60200A60A60-E	L.26
1529390000	IE-FC-SET-SPMCD002-KY-M	I.21
1529570000	IE-FC-IP-PWB-MC	I.17
1529580000	IE-FC-SET-SPDE001-KN-P	I.21

1530000000

1534250000	IE-FC-IP-PWB-RCB0	I.18
------------	-------------------	------

1540000000

1543680000	IE-FC-SET-IPDEK001-KY-P	I.22
1543690000	IE-FC-IP-PWB-3A	I.19
1543710000	IE-FC-IP-PWU/1ST/CB	I.5
1546590000	IE-FC-IP-PWB-AU-10A	I.15
1547440000	IE-CL-240W-PP-BASE	K.10
1547450000	IE-CL-240W-PP-REMOTE	K.10

1550000000

1554000000	IE-FC-IP-PWB-DE-OR	I.12
1556290000	IE-FC-IP-HD15-FF	I.11

1680000000

1689470001	VT SF 5/21 MC NE WS V0	N.24
------------	------------------------	------

1690000000

1699860000	SM 27/18 MC NE WS	L.24
1699860000	SM 27/18 MC NE WS	L.25
1699860000	SM 27/18 MC NE WS	L.26

1700000000

1707270000	SM 27/18 K MC NE WS	I.2
------------	---------------------	-----

1710000000

1713760000	SM 27/18 K MC NE SI	I.2
1716630000	SMH 27/18 SW	L.24
1716630000	SMH 27/18 SW	L.25
1716630000	SMH 27/18 SW	L.26
1718431044	TM 18 MC NE WS	N.24
1718431687	TM 18 MC NE GE	N.24
1719840000	TM 4/12 HF/HB	N.24
1719850000	TM 4/18 HF/HB	N.24

1730000000

1730560001	VT SF 6/21 MC NE WS V0	N.24
1736181044	ESG 7/20 SIRIUS MC NE WS	I.2
1736181044	ESG 7/20 SIRIUS MC NE WS	I.3
1736181044	ESG 7/20 SIRIUS MC NE WS	I.4
1736181044	ESG 7/20 SIRIUS MC NE WS	I.5
1736181044	ESG 7/20 SIRIUS	

Order No.	Type	Page
1900000000		
1900000000	Screwy-M12	L.30
1900000000	Screwy-M12	L.31
1900000000	Screwy-M12	L.34
1900000000	Screwy-M12	L.35
1900001000	Screwy-M12-DM	L.30
1900001000	Screwy-M12-DM	L.31
1900001000	Screwy-M12-DM	L.34
1900001000	Screwy-M12-DM	L.35
1900020000	Screwy-M12 F	J.42
1900021000	ScrewyM12 FDM	J.42
1905490000	M-PRINT PRO	N.23

1910000000

1910000000	Screwy Set	J.42
1910000000	Screwy Set	L.30
1910000000	Screwy Set	L.30
1910000000	Screwy Set	L.31
1910000000	Screwy Set	L.34
1910000000	Screwy Set	L.35

1920000000

1920000000	Screwy Set -DM	J.42
1920000000	Screwy Set -DM	L.30
1920000000	Screwy Set -DM	L.31
1920000000	Screwy Set -DM	L.34
1920000000	Screwy Set -DM	L.35

1960000000

1962430000	IE-PH-RJ45-TH-WH	H.6
1962440000	IE-PH-RJ45-TH-GY	H.6
1962450000	IE-PH-RJ45-TH-OG	H.6
1962470000	IE-PH-RJ45-TH-BU	H.6
1962480000	IE-PH-RJ45-TH-YE	H.6
1962490000	IE-PH-RJ45-TH-GN	H.6
1962500000	IE-PH-RJ45-TH-BK	H.6
1962520000	IE-PH-V04P	J.22
1962520000	IE-PH-V04P	J.26
1962520000	IE-PH-V04P	J.28
1962530000	IE-PH-V04P-BP	J.22
1962530000	IE-PH-V04P-BP	J.26
1962530000	IE-PH-V04P-BP	J.28
1962540000	IE-PH-V05M	J.30
1962550000	IE-PH-V01M	J.12
1962550000	IE-PH-V01M	J.14
1962550000	IE-PH-V01M	J.16
1962560000	IE-PH-V01M-BP	J.12
1962560000	IE-PH-V01M-BP	J.14
1962560000	IE-PH-V01M-BP	J.16
1962720000	IE-PI-RJ45-FH	J.47
1962730000	IE-PI-RJ45-FH	J.46
1962780000	IE-PI-2LC-MM	J.55
1962790000	IE-PI-2LC-SM	J.55
1962840000	IE-BI-RJ45-C	J.49
1962850000	IE-BI-RJ45-FJA	J.48
1962870000	IE-BI-SCRJ2SC-SM-C	J.54
1962880000	IE-BI-LCD-SM-C	J.56
1962970000	IE-PS-LCD-MM	H.8
1962980000	IE-PS-LCD-SM	H.8
1963050000	IE-CR-IP20-RJ45-FH-WH	H.2
1963060000	IE-CR-IP20-RJ45-FH-GY	H.2
1963070000	IE-CR-IP20-RJ45-FH-OG	H.2
1963080000	IE-CR-IP20-RJ45-FH-BU	H.2
1963090000	IE-CR-IP20-RJ45-FH-YE	H.2
1963100000	IE-CR-IP20-RJ45-FH-GN	H.2
1963110000	IE-PS-V05M-RJ45-TH	J.30
1963120000	IE-PS-V01M-RJ45-FH	J.12
1963130000	IE-PS-V01M-RJ45-FH-BP	J.12
1963140000	IE-PS-V01M-RJ45-TH	J.12
1963150000	IE-PS-V01M-RJ45-TH-BP	J.12
1963160000	IE-PS-V04P-RJ45-FH	J.22
1963170000	IE-PS-V04P-RJ45-FH-BP	J.22
1963180000	IE-PS-V04P-RJ45-TH	J.22
1963190000	IE-PS-V04P-RJ45-TH-BP	J.22
1963200000	IE-PS-V05M-RJ45-FH	J.30
1963220000	IE-PS-V01M-2LC-MM	J.16
1963230000	IE-PS-V01M-2LC-MM-BP	J.16
1963240000	IE-PS-V01M-2LC-SM	J.16
1963250000	IE-PS-V01M-2LC-SM-BP	J.16
1963260000	IE-PS-V01M-2SC-MM	J.14
1963270000	IE-PS-V01M-2SC-MM-BP	J.14
1963300000	IE-PS-V01M-2SC-SM	J.14
1963310000	IE-PS-V01M-2SC-SM-BP	J.14
1963320000	IE-PS-V04P-2LC-MM	J.28
1963330000	IE-PS-V04P-2LC-MM-BP	J.28
1963340000	IE-PS-V04P-2LC-SM	J.28
1963350000	IE-PS-V04P-2LC-SM-BP	J.28
1963360000	IE-PS-V04P-2SC-MM	J.26
1963370000	IE-PS-V04P-2SC-MM-BP	J.26
1963400000	IE-PS-V04P-2SC-SM	J.26
1963410000	IE-PS-V04P-2SC-SM-BP	J.26
1963420000	IE-BS-V04P-SCRJ2SC-SM-C	J.27
1963430000	IE-BS-V01M-LCD-SM-C	J.17
1963450000	IE-BS-V04P-LCD-SM-C	J.29
1963460000	IE-BS-V05M-RJ45-FJA	J.31

Order No.	Type	Page
1963470000	IE-BS-V01M-RJ45-C	J.13
1963480000	IE-BS-V01M-RJ45-FJA	J.13
1963490000	IE-BS-V04P-RJ45-C	J.23
1963500000	IE-BS-V04P-RJ45-FJA	J.23
1963510000	IE-BS-V05M-RJ45-C	J.31
1963520000	IE-BH-V04P	J.25
1963530000	IE-BH-V05M	J.31
1963540000	IE-BH-V01M	J.13
1963540000	IE-BH-V01M	J.17
1963580000	IE-PM-RJ45-TH	H.6
1963590000	IE-PS-RJ45-TH-BK	H.6
1963600000	IE-PS-RJ45-FH-BK	H.2
1963700000	IE-BS-V05M-RJ45-FJP	J.31
1963730000	IE-BS-V04P-RJ45-FJ-B	J.23
1963830000	IE-BI-RJ45-FJ-P	J.48
1963840000	IE-BI-RJ45-FJ-B	J.48
1963890000	IE-PP-V04P	N.21
1963900000	IE-PP-V04P	N.21
1964410000	IE-PS-SCD-SM	H.8
1964420000	IE-BI-LCD-MM-C	J.56
1964430000	IE-BI-SCRJ2SC-MM-C	J.54
1964440000	IE-BS-V01M-LCD-MM-C	J.17
1964460000	IE-BS-V04P-LCD-MM-C	J.29
1964470000	IE-BS-V04P-SCRJ2SC-MM-C	J.27
1964480000	IE-PS-SCD-MM	H.8
1965690000	IE-PP-V01P	N.21
1965700000	IE-PP-V01P	N.21
1966220000	IE-OM-V04P-K11-1S	K.14
1966250000	IE-OM-V04P-K21-2S	K.14
1966260000	IE-OM-V05M-K11-1S	K.15
1966290000	IE-OM-V05M-K21-2S	K.15
1966300000	IE-OM-V01M-K11-1S	K.12
1966330000	IE-OM-V01M-K21-2S	K.12
1966780000	IE-KOKV1	N.17
1966790000	IE-KOKV4	N.17
1966810000	IE-KO-HAT	N.17
1968150000	IE-PS-ST-MM	H.7
1968920000	IE-PP-V05M	N.21
1968930000	IE-PP-V05M	N.21

1980000000

1989020000	IE-FC-SET-SPDEK001-KY-P	I.22
------------	-------------------------	------

1990000000

1990600000	IE-CC-V14M-RJ45-FJP	K.3
1990610000	IE-CC-V14M-HYB-10P-FJ	K.7
1990620000	IE-CC-V14M-MF	K.3
1990620000	IE-CC-V14M-MF	K.7
1990630000	IE-CC-VAPM-24V	K.3
1990640000	IE-CC-VAPM-MF	K.3
1992820000	IE-PS-RJ45-FH-180-A-1.6	H.3
1992830000	IE-PS-RJ45-FH-180-B-1.6	H.3
1992840000	IE-PS-RJ45-FH-180-P-1.6	H.5
1992850000	IE-PS-RJ45-FH-180-A-1.1	H.3
1992860000	IE-PS-RJ45-FH-180-B-1.1	H.3
1992870000	IE-PS-RJ45-FH-90-A-1.6	H.4
1992880000	IE-PI-RJ45-FH-A-1.6	H.3
1992880000	IE-PI-RJ45-FH-A-1.6	H.4
1992890000	IE-PS-RJ45-FH-90-B-1.6	H.4
1992900000	IE-PI-RJ45-FH-B-1.6	H.3
1992900000	IE-PI-RJ45-FH-B-1.6	H.4
1992910000	IE-PI-RJ45-FH-P-1.6	H.5
1992910000	IE-PI-RJ45-FH-P-1.6	H.5
1992920000	IE-PI-RJ45-FH-A-1.1	H.3
1992920000	IE-PI-RJ45-FH-A-1.1	H.4
1992930000	IE-PI-RJ45-FH-B-1.1	H.3
1992930000	IE-PI-RJ45-FH-B-1.1	H.4
1993540000	IE-PH-AD-V05M-RJ45	J.30
1993550005	IE-USB-A-A-0.5M	L.45
1993550010	IE-USB-A-A-1.0M	L.45
1993550015	IE-USB-A-A-1.5M	L.45
1993550018	IE-USB-A-A-1.8M	L.45
1993550030	IE-USB-A-A-3.0M	L.45

2000000000

2003390000	IE-FCI-HDMI-MF	I.11
2007230000	IE-FCI-PWB-FR-OR	I.13
2007500000	IE-PS-M12X-P-AWG62/27FH	J.41

2020000000

2027660000	IE-BHD-V04P	J.25
------------	-------------	------

2160000000

2168220000	IE-PCB-M12X-S-90	J.45
------------	------------------	------

2330000000

2330260000	SAI-SK-M12-UNI	N.21
------------	----------------	------

8420000000

8425960000	SAI-SK-M12 BU	N.21
------------	---------------	------

Order No.	Type	Page
8800000000		
8808330000	IE-XRJ45/IDC	J.33
8808340000	IE-XM-ST/ST	H.20
8808360000	IE-XM-RJ45/IDC	H.16
8808370000	IE-S-IP67	K.16
8808380000	IE-P-IP67	J.32
8808420000	IE-CT	N.7
8808440000	IE-XM-RJ45/IDC-IP67	J.33
8808450000	IE-XM-RJ45/RJ45-IP67	J.33

8810000000

8813090000	IE-C-IP67	J.34
8813100000	IE-P	H.6
8813110000	IE-P63	H.6
8813120000	IE-P70	H.6
8813130000	IE-7IC4x2xAWG23/1-PVC	L.7
8813140000	IE-7IC4x2xAWG23/1-PUR	L.7
8813150000	IE-5IC4x2xAWG24/1-PVC	L.6
8813160000	IE-5IC4x2xAWG24/1-PUR	L.6
8813170000	IE-7CC4x2xAWG26/7-PVC	L.9
8813180000	IE-7CC4x2xAWG26/7-PUR	L.9
8813190000	IE-5CC4x2xAWG26/7-PVC	L.8
8813200000	IE-5CC4x2xAWG26/7-PUR	L.8
8813210000	IE-5TC4x2xAWG26/7-PUR	L.13
8813270000	IE-FM62ZV00001MSTOSTOX	M.10
8813280000	IE-FM62ZV00002MSTOSTOX	M.10
8813290000	IE-FM62ZV00003MSTOSTOX	M.10
8813300000	IE-FM5Z2V00001MSDOSDXX	M.10
8813310000	IE-FM5Z2V00002MSDOSDXX	M.10
8813320000	IE-FM5Z2V00003MSDOSDXX	M.10
8813330000	IE-FM62ZV00001MSDOSDXX	M.10
8813340000	IE-FM62ZV00002MSDOSDXX	M.10
8813350000	IE-FM62ZV00003MSDOSDXX	M.10
8813390000	IE-FM5Z2V00002MSTOSTOX	M.11
8813400000	IE-FM62ZV00002MSTOSTOX	M.11
8813490000	IE-DPC	N.21
8813500000	IE-DM	H.16
8813500000	IE-DM	H.17
8813500000	IE-DM	H.20

8820000000

8829440000	IE-XM-6U-RJ45/RJ45-IP67	J.33
8829450000	IE-XM-6D-RJ45/RJ45-IP67	J.33

8870000000

8876350050	IE-FM5Z2V00005MSDOSDXX	M.10
8876350100	IE-FM5Z2V00001MSDOSDXX	M.10
8876360050	IE-FM62ZV00005MSDOSDXX	M.10
8876360100	IE-FM62ZV00001MSDOSDXX	M.10
8876370050	IE-FM5Z2V00005MSTOSTOX	M.10
8876370100	IE-FM5Z2V00001MSTOSTOX	M.10
8876380050	IE-FM62ZV00005MSTOSTOX	M.10
8876380100	IE-FM62ZV00001MSTOSTOX	M.10
8876430010	IE-FM5D2UE0001MSDOSDXX	M.14
8876430030	IE-FM5D2UE0003MSDOSDXX	M.14
8876430050	IE-FM5D2UE0005MSDOSDXX	M.14
8876430100	IE-FM5D2UE0010MSDOSDXX	M.14
8876431000	IE-FM5D2UE00100MSDOSDXX	M.14
8876440010	IE-FM6D2UE0001MSDOSDXX	M.14
8876440030	IE-FM6D2UE0003MSDOSDXX	M.14
8876440050	IE-FM6D2UE0005MSDOSDXX	M.14
8876440100	IE-FM6D2UE0010MSDOSDXX	M.14
8876450010	IE-FM5D2UE0001MSTOSTOX	M.14
8876450030		

Order No.	Type	Page
-----------	------	------

8940000000

8941350003	IE-C6FS8UG0003A40A40-G	L.24
8941350005	IE-C6FS8UG0005A40A40-G	L.24
8941350010	IE-C6FS8UG0010A40A40-G	L.24
8941350015	IE-C6FS8UG0015A40A40-G	L.24
8941350020	IE-C6FS8UG0020A40A40-G	L.24
8941350030	IE-C6FS8UG0030A40A40-G	L.24
8941350050	IE-C6FS8UG0050A40A40-G	L.24
8941350100	IE-C6FS8UG0100A40A40-G	L.24
8941350150	IE-C6FS8UG0150A40A40-G	L.24
8941350200	IE-C6FS8UG0200A40A40-G	L.24
8944310000	IE-C5CS8UG-MW	L.6
8946000000	IE-FM5D2UE-MW	M.5
8946920000	IE-TO-RJ45-C	H.17
8946930000	IE-TO-RJ45-FJ-A	H.15
8946940000	IE-TO-RJ45-FJ-B	H.15
8946950000	IE-TO-RJ45-FJ-P	H.15
8946960000	IE-TO-USB	H.18
8946970000	IE-TO-SCD-MM	H.19
8946980000	IE-TO-SCD-SM	H.19
8946990000	IE-TO-SCRJ-MM	H.19
8947000000	IE-TO-SCRJ-SM	H.19
8947010000	IE-TO-LCD-MM	H.20
8947020000	IE-TO-LCD-SM	H.20
8947670000	IE-C5DD4UG-MW	L.15
8949760000	IE-C5ED8UB-MW	L.13

8950000000

8952950000	IE-XR-RJ45/RJ45-2	J.33
8953160000	IE-C5CS8VG-MW	L.6
8954300000	IE-C7ES8UG-MW	L.9
8955350000	IE-C7BS8UG-MW	L.7
8955360000	IE-C7BS8VG-MW	L.7
8955480000	IE-C7ES8VG-MW	L.9
8955490000	IE-C5ES8VG-MW	L.8
8955560000	IE-C5DS4VG-MW	L.14
8955950000	IE-C5AS4VG-MW	L.14
8956050000	IE-FM6C2UE-MW	M.5
8956060000	IE-FM6D2UE-MW	M.5
8956070000	IE-FM5C2UE-MW	M.5

8960000000

8960670000	IE-C5ED8UB-100M	L.13
------------	-----------------	------

8970000000

8979020000	IE-FM5D2UE0010MLD0LDOX	M.13
8979030000	IE-FM5D2UE0100MLD0LDOX	M.13
8979040000	IE-FM5D2UE0050MLD0LDOX	M.13

8990000000

8993220000	IE-FM6D2UE0050MLD0LDOX	M.13
------------	------------------------	------

9000000000

9002650000	KT 8	N.8
9003750000	M-D-STRIPAX LWL	N.15
9003760000	MEHA KP LWL M-D-SPX	N.15

9010000000

9013960000	ERME 110 PDT	N.16
9013970000	PUNCH DOWN TOOL PDT	N.16
9013980000	ERME 66 PDT	N.16
9013990000	ERME 630 PDT	N.16
9014000000	ERME LSA PLUS STANDARD	N.16
9014050000	ERME LSA PLUS SCHERE	N.16

9030000000

9030060000	AM 12	N.4
9032020000	CASSETTE CST BLAU	N.4

9200000000

9202800000	TT 8 RS MP 8	N.5
9203070000	ERME MULTI-STRIPAX	N.10
9203100000	ERAN MULTI-STRIPAX	N.10
9204350000	IE-CST	N.4
9204370000	IE-FISP-V4	N.16
9204750000	SEE ESD 125	N.9
9204760000	FZE ESD 130	N.9
9204770000	SZE ESD 130	N.9
9204790000	IE-KOK-V5	N.17
9205000000	KOHS 9.5+19	N.17
9205010000	KOHS 19	N.17
9205020000	KOPD 10.0	N.17
9205130000	SEE ESD 120	N.9
9205140000	SVSE ESD 130	N.9
9205150000	SUPER CUT	N.9
9205210000	KOF SET ESD	N.9
9205320000	IE-CT-SC-GOF	N.13
9205330000	IE-CT-LC-GOF	N.13
9205400000	LAN USB TESTER	N.7

We cannot guarantee that there are no mistakes in the publications or software provided by us to the customer for the purpose of making orders. We try our best to quickly correct errors in our printed media.

X

All orders are based on our general terms of delivery, which can be reviewed on the websites of our group companies where you place your order. On demand we can also send the general terms of delivery to you.

Weidmüller – Your partner in Industrial Connectivity

As experienced experts we support our customers and partners around the world with products, solutions and services in the industrial environment of power, signal and data. We are at home in their industries and markets and know the technological challenges of tomorrow. We are therefore continuously developing innovative, sustainable and useful solutions for their individual needs. Together we set standards in Industrial Connectivity.

Weidmüller Interface GmbH & Co. KG
Klingenbergstraße 16
32758 Detmold, Germany
T +49 5231 14-0
F +49 5231 14-292083
info@weidmueller.com
www.weidmueller.com

Your local Weidmüller partner can
be found on our website:
www.weidmueller.com/countries



Made in Germany









Order number: 202170000/11/2015/SMDM

Looking for pricing, stock, or lifecycle information?

Click below to explore more details on WIN SOURCE:

-  [View 1963200000 on WIN SOURCE](#)
-  [Weidmuller Information](#)

Optimize Your Supply Chain with WIN SOURCE Solutions

-  Global Sourcing Solution
-  Obsolete Management
-  Cost Control Management
-  Shortage Management
-  Alternative Solution
-  Excess Inventory Management