



THE DATASHEET OF
691368300010B



1

2

3

4

5

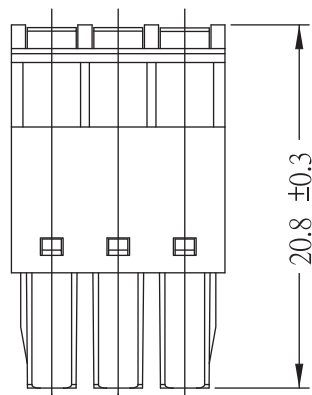
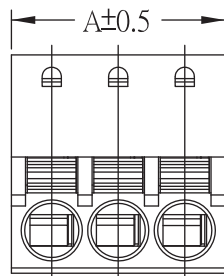

3.81 ±0.1

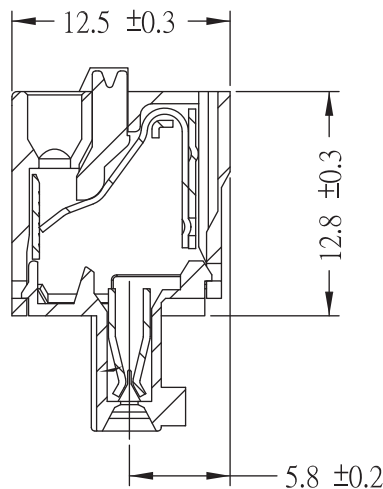

Pitch:3.81mm	
Poles	A(mm)
2	8.42
3	12.23
4	16.04
5	19.85
6	23.66
7	27.47
8	31.28
9	35.09
10	38.90
11	42.71
12	46.52
14	54.14

TECHNICAL CHARACTERISTICS

MATERIAL
 INSULATOR: PA 66
 FLAMABILITY RATING: UL94-V0
 COLOR: GREEN & ORANGE
 METAL SPRING: STAINLESS STRIP STEEL
 WIRE GUARD: PhBz TIN PLATED

ENVIRONMENTAL
 OPERATING TEMPERATURE: -40 UP TO 115°C
 COMPLIANCE: LEAD FREE AND ROHS

ELECTRICAL
 CURRENT RATING: 8A
 WORKING VOLTAGE: 300VAC
 WITHSTANDING VOLTAGE: 2.0KV
 CONTACT RESISTANCE: 20 mOhm max



STANDARD
 cULus CERTIFIED E315414

MECHANICAL
 SOLID WIRE: 28-16 AWG / 0.081-1.31 MM²
 STRANDED WIRE: 28-16 AWG / 0.081-1.31 MM²

WIRE STRIPE LENGTH: 9 MM
 PITCH: 3.81 MM

PACKAGING
 BOX

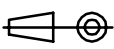
RoHS Compliant

G				PROJECTION: 	GENERAL TOLERANCE .X = +/- 0.2 .XX = +/- 0.15		
F							
E							
D							
C	01-FEB-17	UPDATE	ES	APPROVAL: RJ	UNIT: MM	DESCRIPTION: SERIE 368B - 3.81MM Scewless Vertical Cable Entry Plug	
B	02-JUL-13	STANDARD POLES	QL		SCALE:		
A	20-JUN-12	PDF	GG		SHEET: 1/2	WERI PART NO: 691 368 300 0xx B	SIZE A4
REV	DATE	FILE	BY		DRAW: MARVIN		

1

2

3

4

5

Cautions and Warnings:

This electronic component is designed and developed with the intention for use in general electronics equipments.



Before incorporating the components into any equipments in the field such as aerospace, aviation, nuclear control, submarine, transportation, (automotive control, train control, ship control), transportation signal, disaster prevention, medical, public information network etc. where higher safety and reliability are especially required or if there is possibility of direct damage or injury to human body, Würth Elektronik must be asked for a written approval.

In addition, even electronic component in general electronic equipments, when used in electrical circuits that require high safety, reliability functions or performance, the sufficient reliability evaluation-check for the safety must be performed before by the user before usage.

A

B

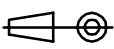
C

RoHS Compliant				PROJECTION: 	GENERAL TOLERANCE .X = +/- 0.2 .XX = +/- 0.15		DESCRIPTION: DISCLAIMER	SIZE A4
G								
F								
E								
D								
C				APPROVAL: JC	UNIT: MM	WERI PART NO: DISCLAIMER	SIZE A4	
B				SCALE:				
A	10-SEP-14	PDF	QL	SHEET: 2/2				
REV	DATE	FILE	BY	DRAW: QL				

D

Looking for pricing, stock, or lifecycle information?

Click below to explore more details on WIN SOURCE:

 [View 691368300010B on WIN SOURCE](#)

 [Wurth Electronics Inc Information](#)

Optimize Your Supply Chain with WIN SOURCE Solutions

-  Global Sourcing Solution
-  Obsolete Management
-  Cost Control Management
-  Shortage Management
-  Alternative Solution
-  Excess Inventory Management