



THE DATASHEET OF
1870640000



LSF-SMT 3.50/02/180 1.5SN BK TU

Weidmüller Interface GmbH & Co. KG
 Klingenbergstraße 26
 D-32758 Detmold
 Germany

www.weidmueller.com

Product image

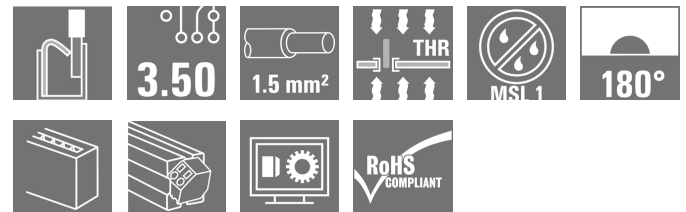

PCB terminal for fully automatic assembly in reflow soldering (SMT), with PUSH IN conductor connection system. Conductor inserted and slider operated in same direction (TOP). Packed in box or as tape on reel. Pin lengths optimised at 1.5 mm or 3.5 mm.

General ordering data

| | |
|--------------|---|
| Version | Printed circuit board terminals, 3.50 mm, Number of poles: 2, 180°, Solder pin length (l): 1.5 mm, black, PUSH IN with actuator, Clamping range, max.: 1.5 mm ² , Tube |
| Order No. | 1870640000 |
| Type | LSF-SMT 3.50/02/180 1.5SN BK TU |
| GTIN (EAN) | 4032248448029 |
| Qty. | 71 pc(s). |
| Product data | IEC: 320 V / 17.5 A / 0.2 - 1.5 mm ² UL: 300 V / 12 A / AWG 28 - AWG 14 |
| Packaging | Tube |

Creation date September 16, 2022 8:02:16 PM CEST

LSF-SMT 3.50/02/180 1.5SN BK TU
Weidmüller Interface GmbH & Co. KG

Klingenbergstraße 26

D-32758 Detmold

Germany

www.weidmueller.com

Technical data
Dimensions and weights

| | | | |
|--------------------------|------------|-----------------|------------|
| Depth | 7.8 mm | Depth (inches) | 0.307 inch |
| Height | 15.5 mm | Height (inches) | 0.61 inch |
| Height of lowest version | 14 mm | Width | 7.7 mm |
| Width (inches) | 0.303 inch | Net weight | 1.577 g |

Temperatures

| | |
|----------------------------------|--------|
| Continuous operating temp., max. | 120 °C |
|----------------------------------|--------|

System parameters

| | | | |
|--|------------------------------|--|-----------------------|
| Product family | OMNIMATE Signal - series LSF | Wire connection method | PUSH IN with actuator |
| Mounting onto the PCB | THT/THR solder connection | Conductor outlet direction | 180° |
| Pitch in mm (P) | 3.5 mm | Pitch in inches (P) | 0.138 inch |
| Number of poles | 2 | Pin series quantity | 1 |
| Fitted by customer | No | Solder pin length (l) | 1.5 mm |
| Solder pin length tolerance | +0.1 / -0.3 | Solder pin dimensions | 0.35 x 0.8 mm |
| Solder pin dimensions = d tolerance | 0 / -0.1 mm | Solder eyelet hole diameter (D) | 1.1 mm |
| Solder eyelet hole diameter tolerance (D) | + 0,1 mm | Number of solder pins per pole | 2 |
| Stripping length | 8 mm | L1 in mm | 3.5 mm |
| L1 in inches | 0.138 inch | Touch-safe protection acc. to DIN VDE 0470 | IP 20 |
| Touch-safe protection acc. to DIN VDE 57 106 | Safe from finger touch | Protection degree | IP20 |
| Volume resistance | 1.60 mΩ | | |

Material data

| | | | |
|---------------------------------------|------------------|---------------------------------------|--------------|
| Insulating material | LCP GF | Colour | black |
| Colour chart (similar) | RAL 9011 | Insulating material group | IIIa |
| Comparative Tracking Index (CTI) | ≥ 175 | Moisture Level (MSL) | 1 |
| UL 94 flammability rating | V-0 | Contact material | Copper alloy |
| Layer structure of solder connection | 4...6 μm Sn matt | Storage temperature, min. | -40 °C |
| Storage temperature, max. | 70 °C | Operating temperature, min. | -50 °C |
| Operating temperature, max. | 120 °C | Temperature range, installation, min. | -30 °C |
| Temperature range, installation, max. | 120 °C | | |

Conductors suitable for connection

| | |
|---|----------------------|
| Clamping range, min. | 0.13 mm ² |
| Clamping range, max. | 1.5 mm ² |
| Wire connection cross section AWG, min. | AWG 28 |
| Wire connection cross section AWG, max. | AWG 14 |
| Solid, min. H05(07) V-U | 0.2 mm ² |
| Solid, max. H05(07) V-U | 1.5 mm ² |
| Flexible, min. H05(07) V-K | 0.2 mm ² |
| Flexible, max. H05(07) V-K | 1.5 mm ² |
| w. plastic collar ferrule, DIN 46228 pt 4, min. | 0.25 mm ² |
| w. plastic collar ferrule, DIN 46228 pt 4, max. | 0.75 mm ² |

Creation date September 16, 2022 8:02:16 PM CEST

Catalogue status 09.09.2022 / We reserve the right to make technical changes.

LSF-SMT 3.50/02/180 1.5SN BK TU

Weidmüller Interface GmbH & Co. KG

Klingenbergstraße 26

D-32758 Detmold

Germany

www.weidmueller.com

Technical data

w. wire end ferrule, DIN 46228 pt 1, min. 0.25 mm²w. wire end ferrule, DIN 46228 pt 1, max. 1.5 mm²

| Clampable conductor | Cross-section for conductor connection | Type | fine-wired |
|--|--|------------------------------|-------------------------------|
| | | nominal | 0.25 mm ² |
| wire end ferrule | wire end ferrule | Stripping length | nominal 10 mm |
| | | Recommended wire-end ferrule | H0.25/12 HBL |
| | | | |
| Cross-section for conductor connection | Cross-section for conductor connection | Type | fine-wired |
| | | nominal | 0.34 mm ² |
| wire end ferrule | wire end ferrule | Stripping length | nominal 10 mm |
| | | Recommended wire-end ferrule | H0.34/12 TK |
| | | | |
| Cross-section for conductor connection | Cross-section for conductor connection | Type | fine-wired |
| | | nominal | 0.5 mm ² |
| wire end ferrule | wire end ferrule | Stripping length | nominal 10 mm |
| | | Recommended wire-end ferrule | H0.5/14 OR |
| | | | |
| Cross-section for conductor connection | Cross-section for conductor connection | Type | fine-wired |
| | | nominal | 0.75 mm ² |
| wire end ferrule | wire end ferrule | Stripping length | nominal 10 mm |
| | | Recommended wire-end ferrule | H0.75/14T HBL |
| | | | |

Reference text Length of ferrules is to be chosen depending on the product and the rated voltage., The outside diameter of the plastic collar should not be larger than the pitch (P)

Rated data acc. to IEC

| tested acc. to standard | IEC 60664-1, IEC 61984 | Rated current, min. number of poles (Tu=20°C) | 17.5 A |
|---|------------------------|---|------------------|
| Rated current, max. number of poles (Tu=20°C) | 16 A | Rated current, min. number of poles (Tu=40°C) | 17.5 A |
| Rated current, max. number of poles (Tu=40°C) | 14 A | Rated voltage for surge voltage class / pollution degree II/2 | 320 V |
| Rated voltage for surge voltage class / pollution degree III/2 | 160 V | Rated voltage for surge voltage class / pollution degree III/3 | 160 V |
| Rated impulse voltage for surge voltage class/ pollution degree II/2 | 2.5 kV | Rated impulse voltage for surge voltage class/ pollution degree III/2 | 2.5 kV |
| Rated impulse voltage for surge voltage class/ contamination degree III/3 | 2.5 kV | Short-time withstand current resistance | 3 x 1s with 80 A |

Rated data acc. to CSA

| Institute (CSA) |  | Certificate No. (CSA) | 200039-1664286 |
|-----------------------------------|---|-----------------------------------|----------------|
| Rated voltage (Use group B / CSA) | 300 V | Rated voltage (Use group D / CSA) | 300 V |
| Rated current (Use group B / CSA) | 10 A | Rated current (Use group D / CSA) | 10 A |
| Wire cross-section, AWG, min. | AWG 28 | Wire cross-section, AWG, max. | AWG 14 |
| Reference to approval values | Specifications are maximum values, details - see approval certificate. | | |

LSF-SMT 3.50/02/180 1.5SN BK TU

Weidmüller Interface GmbH & Co. KG
Klingenbergstraße 26
D-32758 Detmold
Germany

www.weidmueller.com

Technical data

Rated data acc. to UL 1059

Institute (cURus)



Certificate No. (cURus)

E60693

| | | | |
|---------------------------------------|--|---------------------------------------|--------|
| Rated voltage (Use group B / UL 1059) | 300 V | Rated voltage (Use group D / UL 1059) | 300 V |
| Rated current (Use group B / UL 1059) | 12 A | Rated current (Use group D / UL 1059) | 10 A |
| Wire cross-section, AWG, min. | AWG 28 | Wire cross-section, AWG, max. | AWG 14 |
| Reference to approval values | Specifications are maximum values, details - see approval certificate. | | |

Packing

| | | | |
|--------------------|-------------------------------|------------|--------|
| Packaging | Tube | VPE length | 556 mm |
| VPE width | 20 mm | VPE height | 16 mm |
| Surface resistance | $R_s = 10^9 - 10^{12} \Omega$ | | |

Classifications

| | | | |
|-------------|-------------|-------------|-------------|
| ETIM 6.0 | EC002643 | ETIM 7.0 | EC002643 |
| ETIM 8.0 | EC002643 | ECLASS 9.0 | 27-44-04-01 |
| ECLASS 9.1 | 27-44-04-01 | ECLASS 10.0 | 27-44-04-01 |
| ECLASS 11.0 | 27-46-01-01 | ECLASS 12.0 | 27-46-01-01 |

Important note

| | |
|----------------|--|
| IPC conformity | Conformity: The products are developed, manufactured and delivered according international recognized standards and norms and comply with the assured properties in the data sheet resp. fulfill decorative properties in accordance with IPC-A-610 "Class 2". Further claims on the products can be evaluated on request. |
| Notes | <ul style="list-style-type: none"> • Additional push button colours on request • Operating force of slider max. 40 N • Rated current related to rated cross-section & min. No. of poles. • Wire end ferrule with plastic collar to DIN 46228/4 • Wire end ferrule without plastic collar to DIN 46228/1 • P on drawing = pitch • Rated data refer only to the component itself. Clearance and creepage distances to other components are to be designed in accordance with the relevant application standards. • Crimping shape "A" for wire end ferrules with PZ 6/5 crimping tool recommended. • Long term storage of the product with average temperature of 50 °C and average humidity 70%, 36 months |

LSF-SMT 3.50/02/180 1.5SN BK TU

Weidmüller Interface GmbH & Co. KG
Klingenbergstraße 26
D-32758 Detmold
Germany

www.weidmueller.com

Technical data

Approvals

Approvals



| | |
|-------------------------|------------|
| ROHS | Conform |
| UL File Number Search | UL Website |
| Certificate No. (cURus) | E60693 |

Downloads

| | |
|---|--|
| Approval/Certificate/Document of Conformity | Declaration of the Manufacturer |
| Engineering Data | CAD data – STEP |
| Engineering Data | EPLAN, WSCAD |
| Catalogues | Catalogues in PDF-format |
| Brochures | FL DRIVES EN FL ANALO.SIGN.CONV. EN MB SMT EN FL DRIVES DE MB DEVICE MANUF. EN FL BUILDING SAFETY EN FL APPL LED LIGHTING EN FLIndustr.CONTROLS EN FL MACHINE SAFETY EN FL HEATING ELECTR EN FL APPL INVERTER EN FL_BASE_STATION_EN FL ELEVATOR EN FL POWER SUPPLY EN FL 72H SAMPLE SER EN PO OMNIMATE EN PO OMNIMATE EN |
| White paper surface mount technology | Download Whitepaper |

LSF-SMT 3.50/02/180 1.5SN BK TU

Weidmüller Interface GmbH & Co. KG
 Klingenbergstraße 26
 D-32758 Detmold
 Germany

www.weidmueller.com

Drawings

Product image

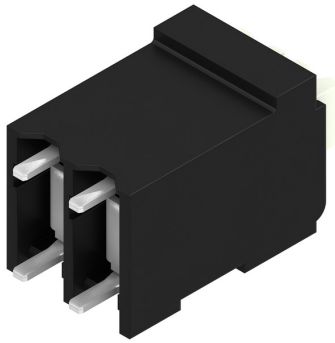

Dimensional drawing

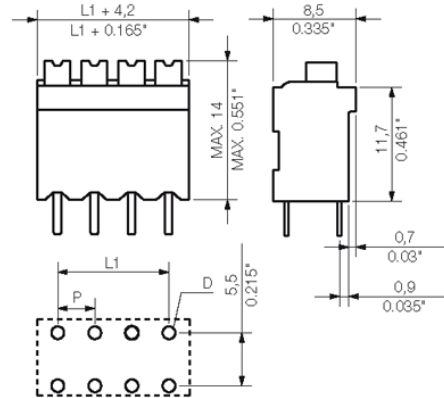

Graph

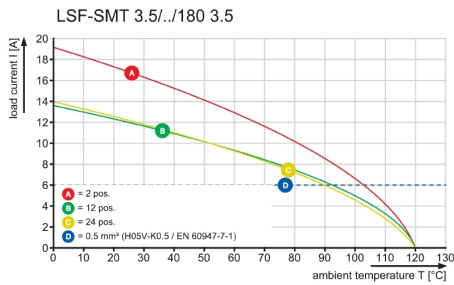

Graph

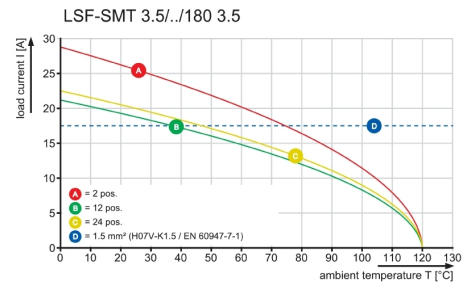

The reproduction, distribution and utilization of this document as well as the communication of its contents to others without explicit authorization is prohibited. Offenders will be held liable for the payment of damages. Weidmüller exclusively reserves the right to file for patents, utility models or designs.

© Weidmüller Interface GmbH & Co. KG

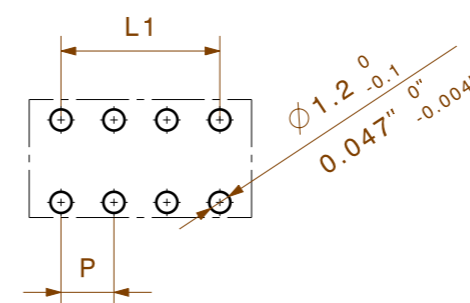
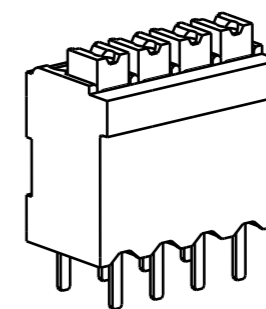
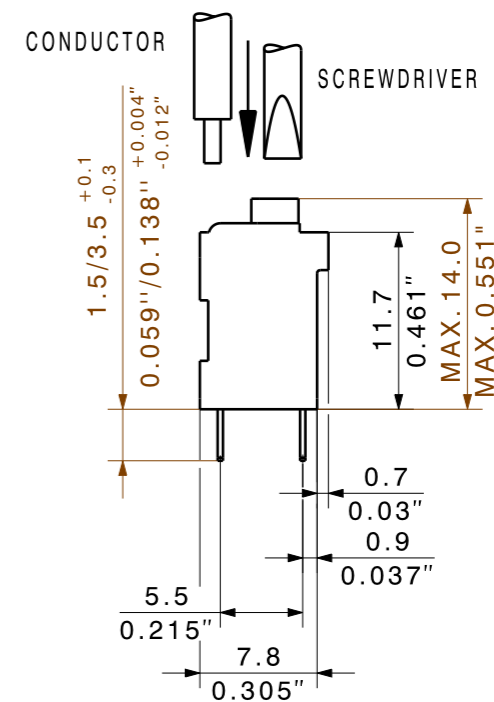
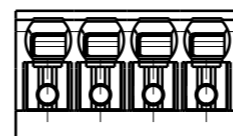
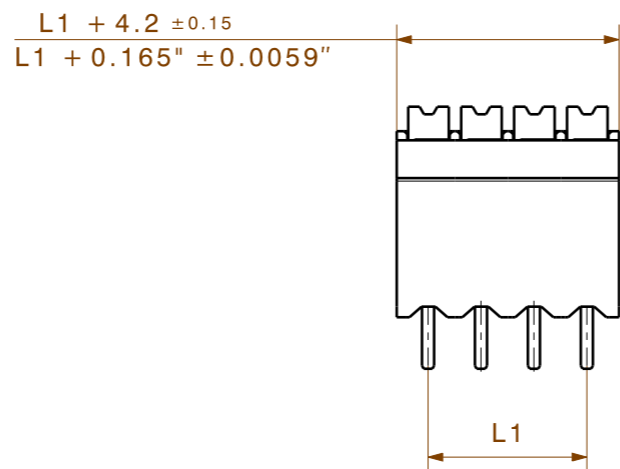

HOLE PATTERN

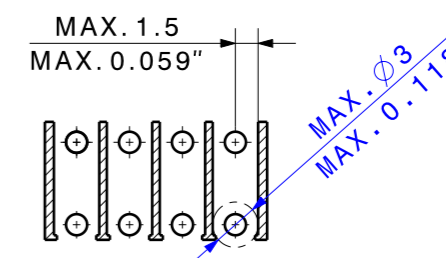

PASTE-FREE AREA

P=3.50

SHOWN: LSF-SMT 3.50/04/180

| | | |
|----|---------|-----------|
| 24 | 80,50 | 3,169 |
| 23 | 77,00 | 3,031 |
| 22 | 73,50 | 2,894 |
| 21 | 70,00 | 2,756 |
| 20 | 66,50 | 2,618 |
| 19 | 63,00 | 2,480 |
| 18 | 59,50 | 2,343 |
| 17 | 56,00 | 2,205 |
| 16 | 52,50 | 2,067 |
| 15 | 49,00 | 1,929 |
| 14 | 45,50 | 1,791 |
| 13 | 42,00 | 1,654 |
| 12 | 38,50 | 1,516 |
| 11 | 35,00 | 1,378 |
| 10 | 31,50 | 1,240 |
| 9 | 28,00 | 1,102 |
| 8 | 24,50 | 0,965 |
| 7 | 21,00 | 0,827 |
| 6 | 17,50 | 0,689 |
| 5 | 14,00 | 0,551 |
| 4 | 10,50 | 0,413 |
| 3 | 7,00 | 0,276 |
| 2 | 3,50 | 0,138 |
| n | L1 [mm] | L1 [Inch] |

For the mounting on PCBs, it should be noted that the rated data relates only to the PCB components alone. The necessary creepage and clearance paths must be observed in the relevant equipment standards in accordance with IEC 664 / VDE 0110. The current-carrying capacity and pitch tolerance is to be determined according to DIN IEC 326 part 3.

Weidmüller PCB components are rated in accordance with the DIN EN 61984 standard, and are valid for its field of application. If the components are used in accordance with the intended purpose, the components will meet all requirements with respect to the occurring of electrical, mechanical, thermic and corrosive stress.

| | | | | | |
|---------------|----------------|---------------------------------|-----------|--|----------------------------|
| | DIN ISO 2768-m | 98688/5 23.10.17 HELIS_MA 00 | | | Cat.no.: |
| | Modification | Date | Name | | 3 34084 15 |
| | Drawn | 22.06.2004 | SEIDEL_T | LSF-SMT .../.../180...TU LEITERPLATTENKLEMME PCB TERMINAL | Drawing no. Issue no. |
| Scale: 5/1 | Responsible | | KRUG_M | | Sheet 01 of 07 sheets |
| Supersedes: . | Checked | 01.11.2017 | HELIS_MA | | Product file: LSF-SMT 7358 |
| | Approved | | HECKERT_M | | |

Recommended wave soldering profiles

Weidmüller Interface GmbH & Co. KG
 Klängenbergstraße 16
 D-32758 Detmold
 Germany
 Fon: +49 5231 14-0
 Fax: +49 5231 14-292083
 www.weidmueller.com

Single Wave:



Double Wave:



Wave soldering profiles

Wired connection elements should be processed in accordance with the DIN EN 61760-1 standard. We have included two recommendations for practical wave soldering profiles, with which Weidmüller PCB terminals and connectors are qualified.

When choosing a suitable profile for your application, the following factors also need to be considered:

- PCB thickness
- Proportion of Cu in the layers
- Single/double-sided assembly
- Product range
- Heating and cooling rates

The single and double wave profiles each indicate the recommended operating range, including the maximum soldering temperature of 260°C. In practice, the maximum soldering temperature is quite often well below the above maximum profile.

Recommended reflow soldering profile

Weidmüller Interface GmbH & Co. KG
 Klingenbergstraße 16
 D-32758 Detmold
 Germany
 Fon: +49 5231 14-0
 Fax: +49 5231 14-292083
 www.weidmueller.com



Reflow soldering profile

The perfect soldering profile for SMT Surface Mount Technology is one the most exiting question in SMT production. But there are more than one correct answer: The diagram of temperature-on-time is related to processing features of solder paste and to maximum load of components.

We have to consider the following parameters:

- Time for pre heating
- Maximum temperature
- Time above melting point
- Time for cooling
- Maximum heating rate
- Maximum cooling rate

We recommend a typical solder profile with associated process limits. With preheating components and board are prepared smoothly for the solder phase. Heating rate is typically $\leq +3\text{K/s}$. In parallel the solder paste is ‚activated‘. The time above melting point of 217°C the paste gets liquid and components and boards begin to connect. The maximum temperature of 245°C to 254°C should stay between 10 and 40 seconds. In the cooling phase at $\geq -6\text{K/s}$ solder is cured. Board and components cool down while avoiding cold cracks.

Mouser Electronics

Authorized Distributor



Click to View Pricing, Inventory, Delivery & Lifecycle Information:

[Weidmuller:](#)

[1870640000](#)

Looking for pricing, stock, or lifecycle information?

Click below to explore more details on WIN SOURCE:

-  [View 1870640000 on WIN SOURCE](#)
-  [Weidmuller Information](#)

Optimize Your Supply Chain with WIN SOURCE Solutions

-  Global Sourcing Solution
-  Obsolete Management
-  Cost Control Management
-  Shortage Management
-  Alternative Solution
-  Excess Inventory Management